



dodici<sup>®</sup>

## lafano®... oltre l'ufficio

La storia di questa azienda è fatta di passione, entusiasmo e lavoro. Nel 1996, dopo un'esperienza ventennale nel settore, **lafano®** si ripropone al mercato delle pareti attrezzate con nuovi obiettivi: semplicità, efficienza, servizio. Nel 2002 il nuovo corso aziendale. Con nuovi e importanti investimenti, i prodotti vengono riprogettati e nascono **metrica®** e **quadra®**, viene introdotta la parete monolitica **unica®** viene presentato al mercato un catalogo-rivista senza precedenti che mostra i prodotti, suggerendo nuovi scenari e nuove atmosfere, conducendo i clienti "oltre l'ufficio". Investendo in design, comunicazione, e in un gruppo di lavoro costituito da tecnici e professionisti sempre più ampio, **lafano®** ha posto l'attenzione sul vero valore aggiunto della "parete": la consulenza, la progettazione, il servizio, la competenza tecnica. Nel 2007, l'immagine aziendale viene perfezionata, inizia una campagna pubblicitaria semplice ed incisiva, vengono proposte tre nuove pareti: **ritmica®**, **unica® s**, parete monolastra attrezzabile, infine **unica® d** parete con doppio vetro da 51 mm. Durante l'evento "con noi ... fano 28 giugno 2007", **lafano®** presenta a clienti, amici e collaboratori, i risultati di un miglioramento continuo visibile in uno stabilimento di 8.000 metri quadrati perfettamente organizzato, nel nuovo ufficio tecnico, nella nuova show room, in realizzazioni svolte in tutto il mondo. Nel 2008 viene conseguita la certificazione ISO 9001 e vengono eseguite le prove di laboratorio per la certificazione di tutte le tipologie di prodotto. Nel 2010 vengono conseguite sei certificazioni di sistema e la ISO 14001. Oggi **lafano®** è un'azienda che non si limita ad accontentare genericamente il Cliente. La sua mission è quella di realizzarne appieno le idee progettuali e le esigenze funzionali, creando ambienti di lavoro di grande valore tecnico ed estetico.

The story of this company is one of passion, enthusiasm and commitment. In 1996, after more than 20 years in this sector, **lafano®** introduces its products in the market of partition walls. In 2002 the company started a process of deep innovation. Through important and new investments, all the products were re-designed: the collections **metrica®** and **quadra®** were created together with the new concept of the monolithic partition, **unica®**. The company published an unprecedented catalogue-magazine which tells all about the products while suggesting new scenarios and new atmospheres, taking the customer by hand to go "beyond the office". Through major investments in design, communication and in the work group, composed of an ever-growing team of technicians and professionals, **lafano®** emphasises what the real added value of its partition walls: expertise, design skills, customer service and knowledge base. In 2007 the corporate image is perfected and an impressive, though simple, advertising campaign launches three new partitions: **ritmica®**, **unica® s**, a full-height single-glass partition with storage and accessories and **unica® d**: a double-glass 51-mm thick partition. During the June 2007 event "con noi ... fano 28 giugno 2007" (which means "with us"), **lafano®** presents to customers, friends and collaborators the results of these non-stop improvements, materialised in an 8,000 sqm highly organised factory, in a new technical department, in the new showroom and in projects accomplished all over the world. In the summer 2008 the company obtains the ISO 9001 certificate and a series of technical tests by "Istituto Giordano" certify all the collections. In 2010 six new system certificates and ISO 14001 are obtained. Today **lafano®** is a company which goes beyond the commitment of mere customer satisfaction. Its mission is to fully meet their expectations, creating workspaces of high technical and aesthetic value

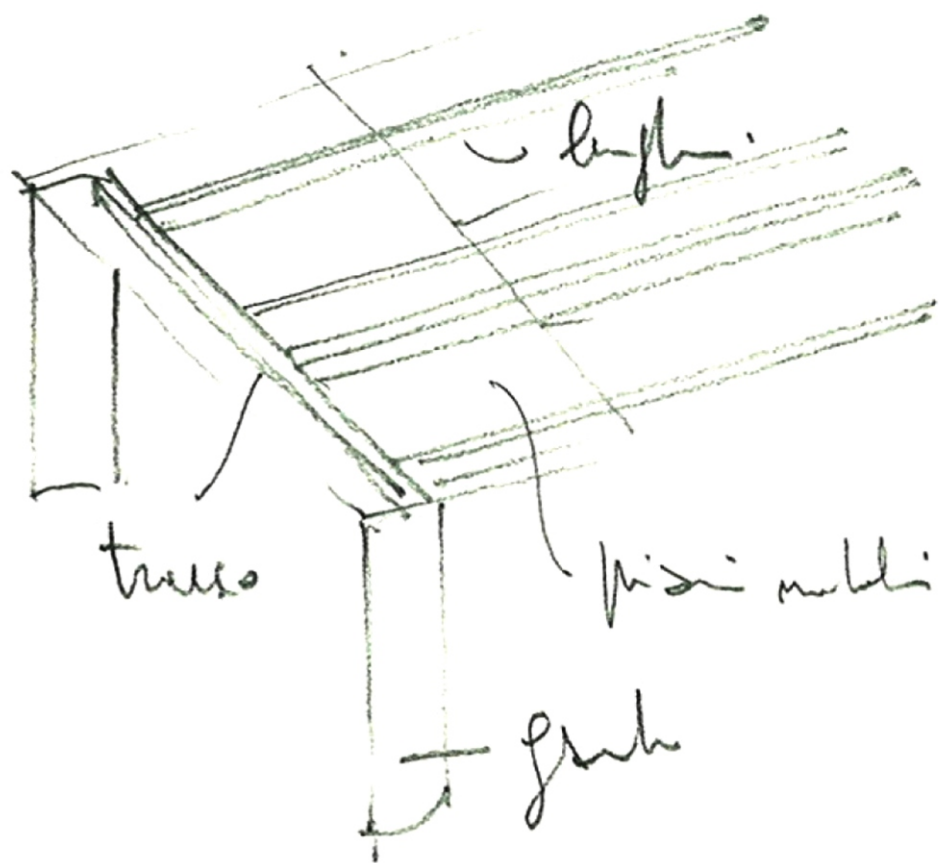

cos'è il **dodici**®

Tavoli operativi, direzionali e riunione, a quattro gambe perimetrali in alluminio con piani in hpl unicolor o vetro, tutto in spessore 12 mm. Geometrie semplici e regolari pensate per affrontare layout flessibili e innovativi. Un progetto che afferma con rinnovata sobrietà ed eleganza i valori del minimalismo e dell'innovazione nel mobile da ufficio. Le postazioni, singole o a "banch", sono a piano singolo o composto, con inserto centrale attrezzabile e schermi divisori in vetro o legno. Le gambe sono dotate di piani accessori di varie dimensioni. La collezione si completa con cassettiere, mobili di servizio e contenitori in legno o metallo, oggi arricchita dalla variante con piani da 18mm.

Work tables, executive desks and meeting room tables, with four aluminium legs and tops in unicolor HPL or glass, all elements are 12 mm thick. Simple and harmonised geometry to obtain versatile and innovative layouts. A project that states with new sobriety and elegance the value of minimalism and of innovation in office furniture. Workstations, single or in bench configurations, have a single or composite top, with a central insert for wiring and connections to accessories. Screens between workstations can be solid or glazed. Legs can be fitted with storage elements of various sizes. The complete range includes drawer sets, service tables and metal or wood storage units. The **dodici**® collection has been enhanced with the new 18-mm-thick tops.



piano in spessore 12 mm.  
*12-mm-thick top.*



piano in spessore 18 mm.  
*12-mm-thick top.*



# INDICE

CONTENTS

POSTAZIONI OPERATIVE workstations	12/29
TAVOLI DIREZIONALI executive desks	32/45
TAVOLI RIUNIONI meeting tables	48/63
CONTENITORI storages	66/73
FINITURE finishes	76/97





postazioni operative  
workstations

Dalla singola postazione ai bench uniti con piani di servizio bassi, **dodici**® risponde con sobrietà e praticità alle esigenze degli uffici moderni. I piani dattilo ampliano le superfici di lavoro, migliorando operatività e confort. Gli schermi divisorii separano, mantenendo unito l'ambiente lavorativo. Soluzioni per garantire la privacy e consentire comunque la relazione visiva tra operatori.

*From the individual workstation to shared benches with low service worktops, **dodici**® gives a sober and practical response to the needs of modern workplaces. Typing desks provide extra work space and improve functionality and comfort. The low partition screens separate and at the same time maintain unity in the work environment. They are the ideal solution to preserve privacy and allow a visual relationship between the operators.*







Accessori funzionali per un cablaggio versatile, ideale per garantire ordine nella postazione di lavoro.

*Functional accessories for versatile wiring solutions that keep the workstation tidy.*











Divisori sottili, in vetro o hpl. Divisori di campo, confini netti che isolano senza interrompere la percezione dello spazio circostante. Accessori che non interferiscono con la comunicazione e contribuiscono, con stile, a garantire una adeguata concentrazione.

*Thin screens made of glass or HPL to outline neat borders that divide without interrupting the perception of the surrounding space. Accessories that never interfere with communications and help concentration while creating a stylish environment.*











Un piano di servizio ad una quota diversa. Una funzione aggiuntiva per attrezzature documenti o accessori.

*Service table placed at a different height. An additional function to store hardware, documents or accessories.*











Il piede trasparente per far volare la gamba, per mascherare il contatto, creando un appoggio stabile e invisibile.

*The transparent foot gives lightness to the leg and masks the contact, creating a stable and invisible base.*



postazioni operative  
workstations

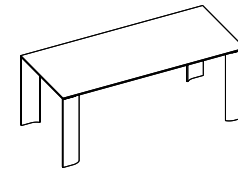
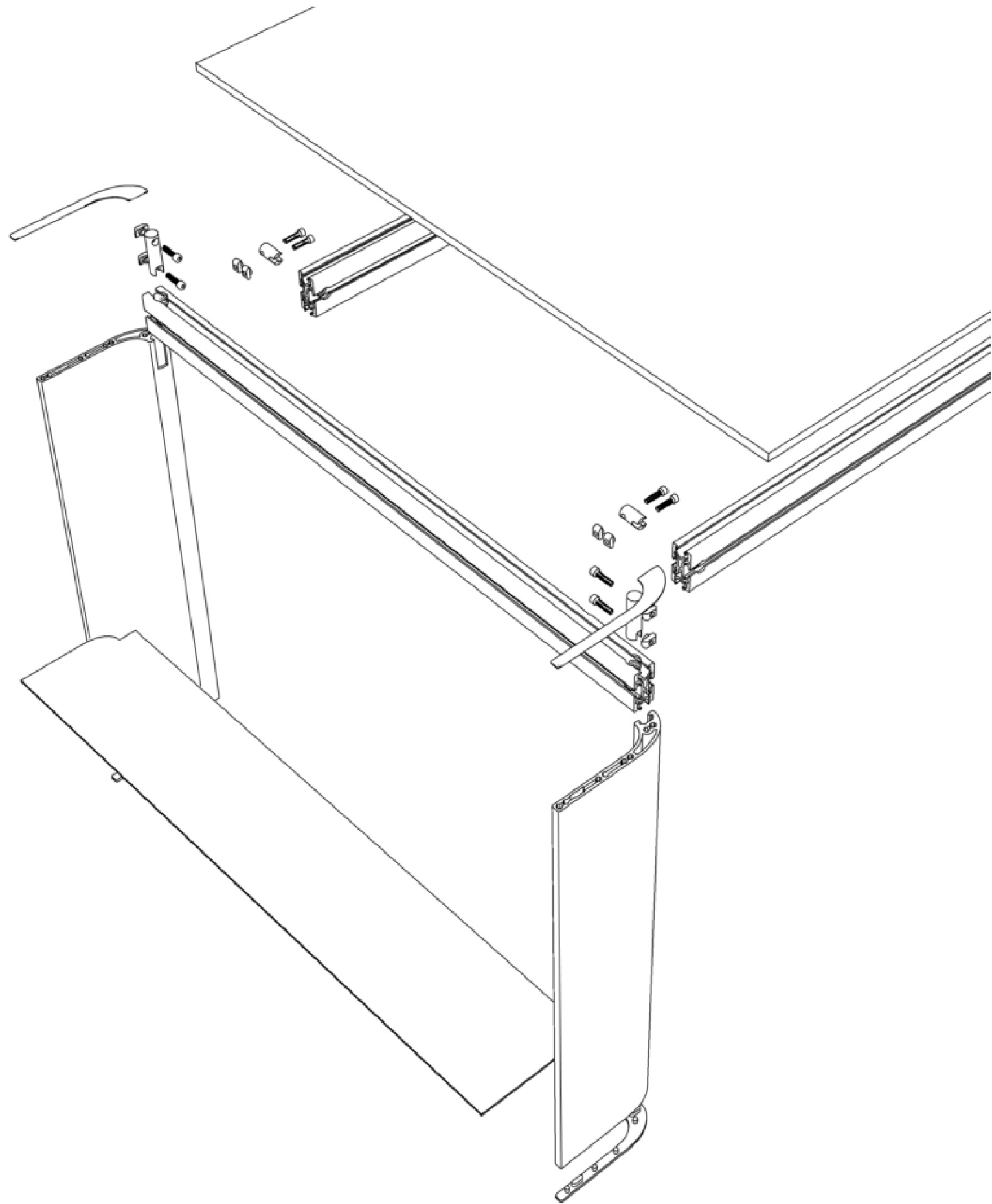

postazione singola  
single workstation

180 x 80    180 x 100  
200 x 80    200 x 100  
240 x 80    240 x 100  
              300 x 100

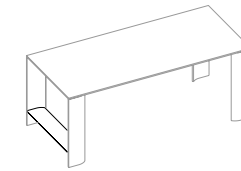

portacomputer  
computer holder

80  
100

banch  
bench

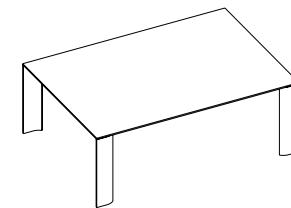

postazione doppia  
double workstation

180 x 160  
200 x 160  
240 x 160

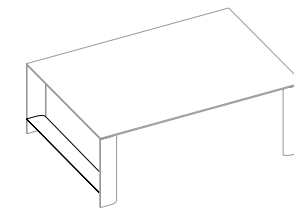

portacomputer  
computer holder

160

schermi divisori e dattilo  
screens and typing desks

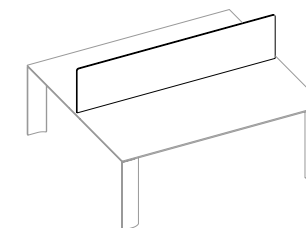

schermo divisorio  
partition screen

180  
200  
240

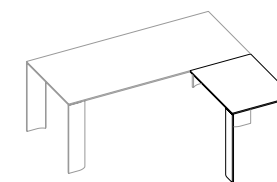

dattilo  
typing desk

80 x 60    80 x 80  
100 x 60    100 x 80  
120 x 60    120 x 80

cassettiere e accessori  
drawers and accessories

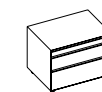

cassettiera con  
porta cancelleria  
drawer with stationery tray

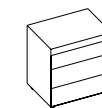

cassettiera con  
3 cassetti  
three-drawer chest

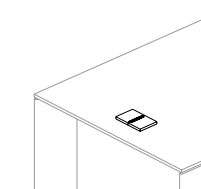

passacavi  
wiring lid



vertebra  
vertebra

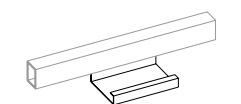

canalina passacavi  
wiring channel





## tavoli direzionali

*executive desks*

Scrivanie minimali, in cui gli spessori sono ridotti e le resistenze aumentate fino ai limiti strutturali. Un gioco stilistico sorprendente in cui l'assoluta leggerezza esprime grande resistenza e stabilità. **dodici**® impone, con gusto ed efficacia, il fascino discreto dell'autorevolezza senza ostentazione. Il mobile di servizio dalla linea netta e definita, completa la postazione, sostenendo il piano lievemente. Una composizione modulare a doppia struttura che consente la variazione di dotazioni e finiture. Cassettiere, vani a giorno, portacase, moduli ad anta, definiscono in modo nuovo il contenitore classico della postazione direzionale.

*Minimal desks where thickness is reduced and resistance is increased up to the material structural limit. Astonishing style where absolute lightness is matched to strength and stability. **dodici**® stands out, with taste and effectiveness, for its detached charm. The service table completes the workstation with neat lines, lightly supporting the desk top. The double-frame modular composition allows great versatility in configurations: drawer sets, open shelves and cabinets that define in a new way the concept of office storage for executives.*











Piani di lavoro sovrapposti, materiali opachi o lucidi, mobili che nascondono o lasciano intravedere. L'importanza di una postazione direzionale alleggerita da giochi di forme e colori.

*Overlapping worktops, matt or glossy surfaces, furniture that hides and shows to lighten executive workstations in a game of forms and colours.*









Piccoli ripiani che sostengono con leggerezza, elementi funzionali per computer e stampanti. Supporti eleganti attraverso cui la forma segue la funzione, con sobrietà e rigore.

*Small and functional shelves to hold accessories and printers: forms follow functions, neatly and elegantly.*







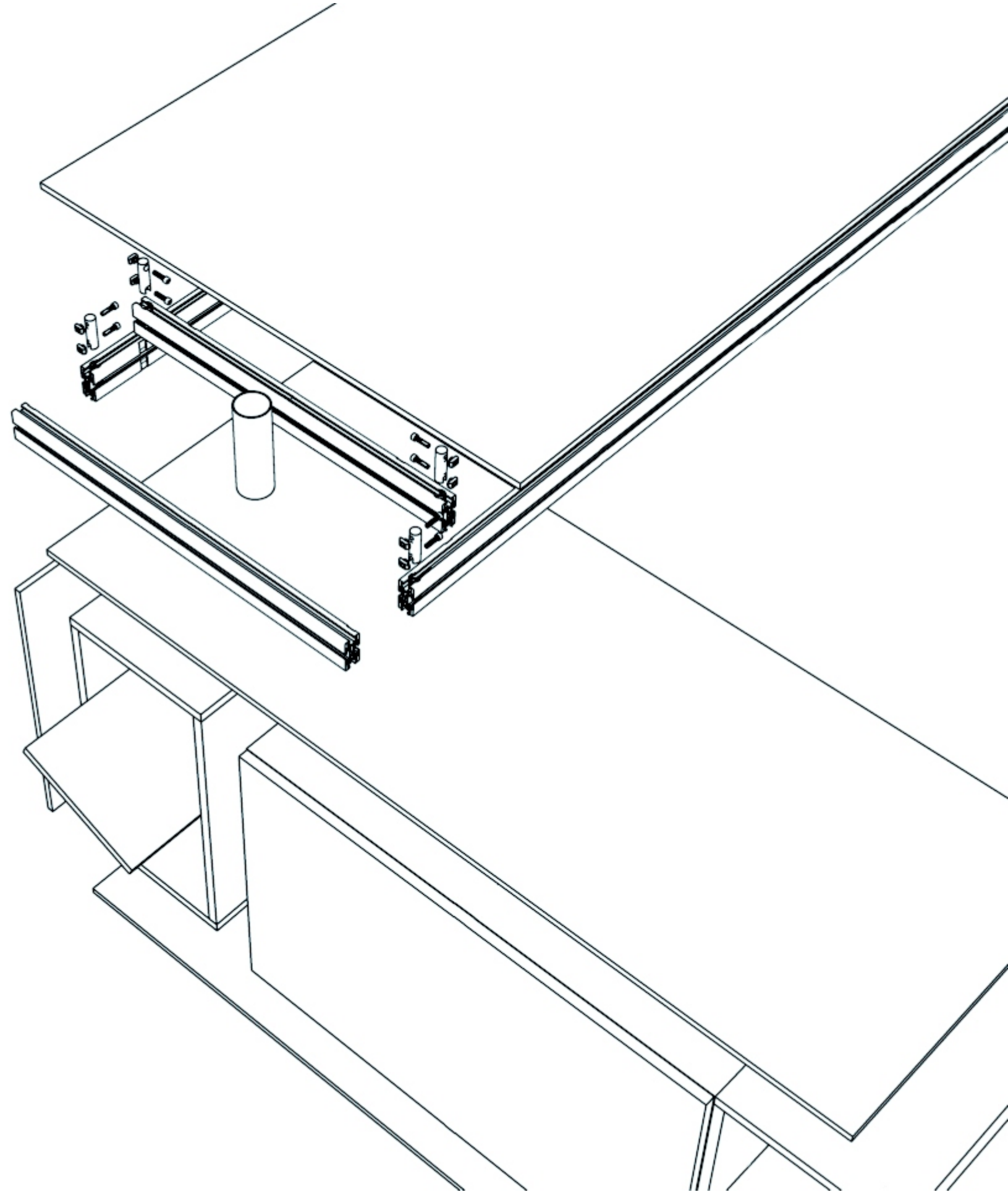

tavoli direzionali  
*executive desks*

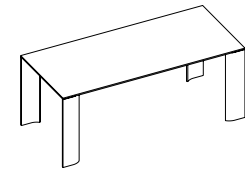

200 x 100  
240 x 100

postazione singola  
*workstations*

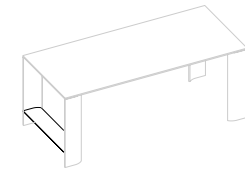

100

portacomputer  
*computer holder*

mobile di servizio componibili  
*modular service table*

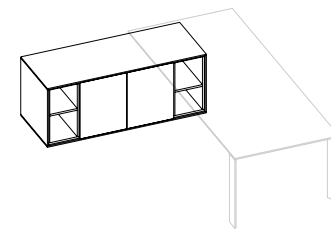

mobile con parti a giorno 153 x 60  
*cabinet with open shelves 153x60*

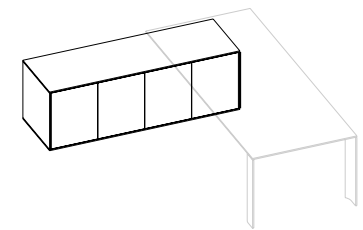

mobile chiuso 183 x 60  
*closed cabinet 183x60*

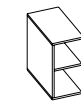

contenitore a giorno 30 x 60  
*open storage unit 30x60*

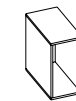

contenitore portacase 30 x 60  
*computer cabinet 30x60*

modesty panel  
*modesty panel*

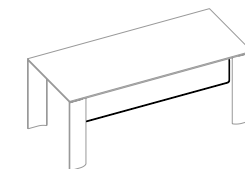

160  
200  
300

modesty panel  
*modesty panel*

cassettiere e accessori  
*drawers and accessories*

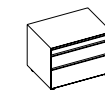

cassettiera con porta cancelleria  
*drawer with stationery tray*

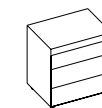

cassettiera con 3 cassetti  
*three-drawer chest*

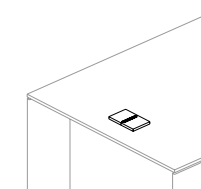

passacavi  
*wiring lid*



vertebra  
*vertebra*

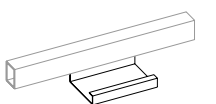

canalina passacavi  
*wiring channel*

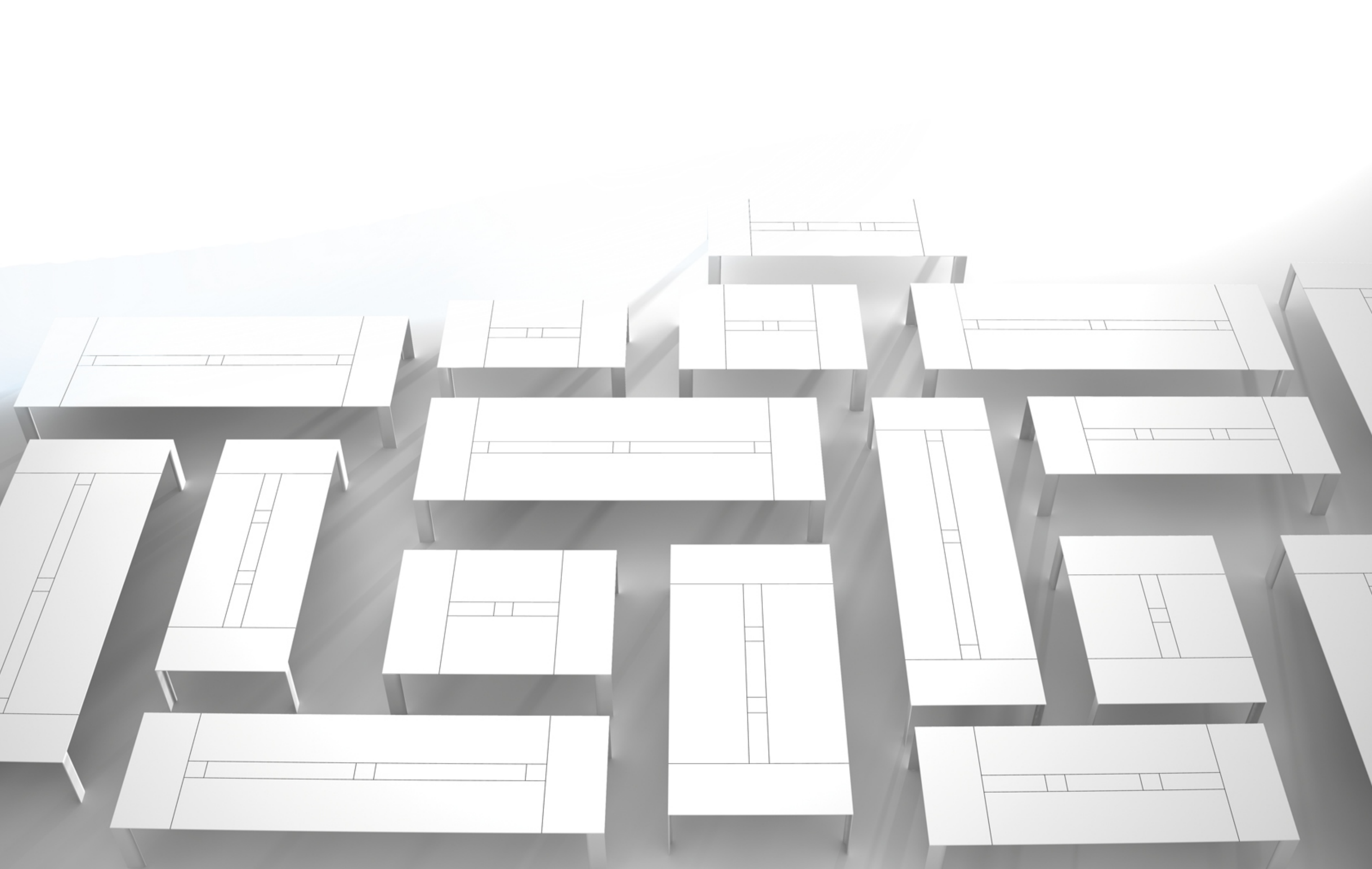



## tavoli riunioni

meeting tables

Tavoli riunioni di lunghezza inimmaginabile. Tavoli dalle proporzioni sorprendenti in cui la stabilità è espressa con leggerezza. La struttura modulare, il sapiente studio strutturale, la qualità dei materiali e delle giunzioni, consentono di soddisfare ogni esigenza dimensionale fino ai limiti spaziali dell'ambiente in cui dodici è inserito. Il piano è arricchito da una fascia centrale, diversa per colore o materiale, in cui è possibile inserire moduli elettrificati che rendono agevole ogni operazione di cablaggio. Tavoli eleganti, sobri, resistenti, funzionali, un trionfo di stile italiano.

*Surprisingly long meeting tables. Unexpected proportions where stability meets lightness. The modular frame and a wise study of structures, materials and junctions allow to meet any dimensional need with the only limitations of space availability. The central piece, different in colour and texture, can house wiring and switches. dodici® meeting room tables are elegant, sober, resistant, functional: a pure expression of Italian style.*









Tavoli per la riunione da comporre e cablare con praticità ed funzionalità. Gestì semplici per connettere e collegare, semplicemente.

*Meeting tables that can be compounded and wired in a practical and functional way. Simple actions to connect and link with simplicity.*







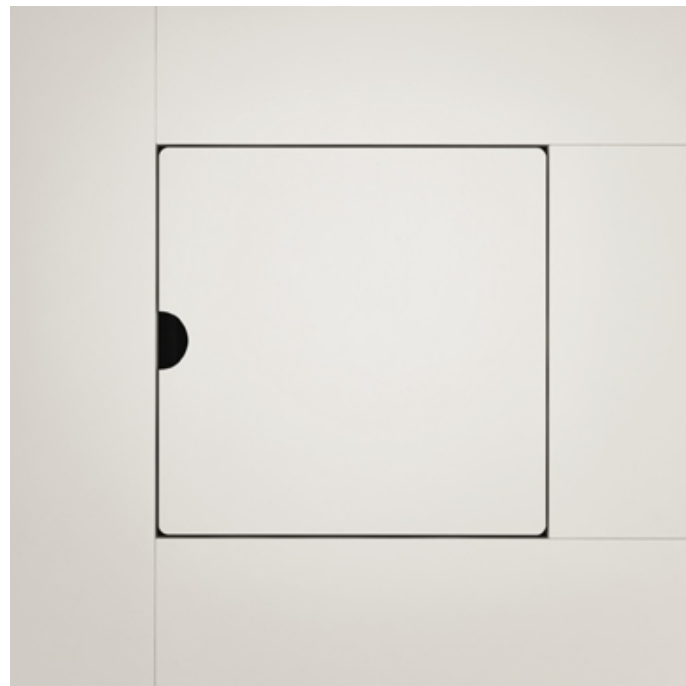

Un piano, una gamba, uno spessore ridotto, dodici millimetri  
su cui scrivere e comunicare, stabilmente.

The top, the legs, minimal thickness, twelve steady millimeters  
where you can write and communicate.











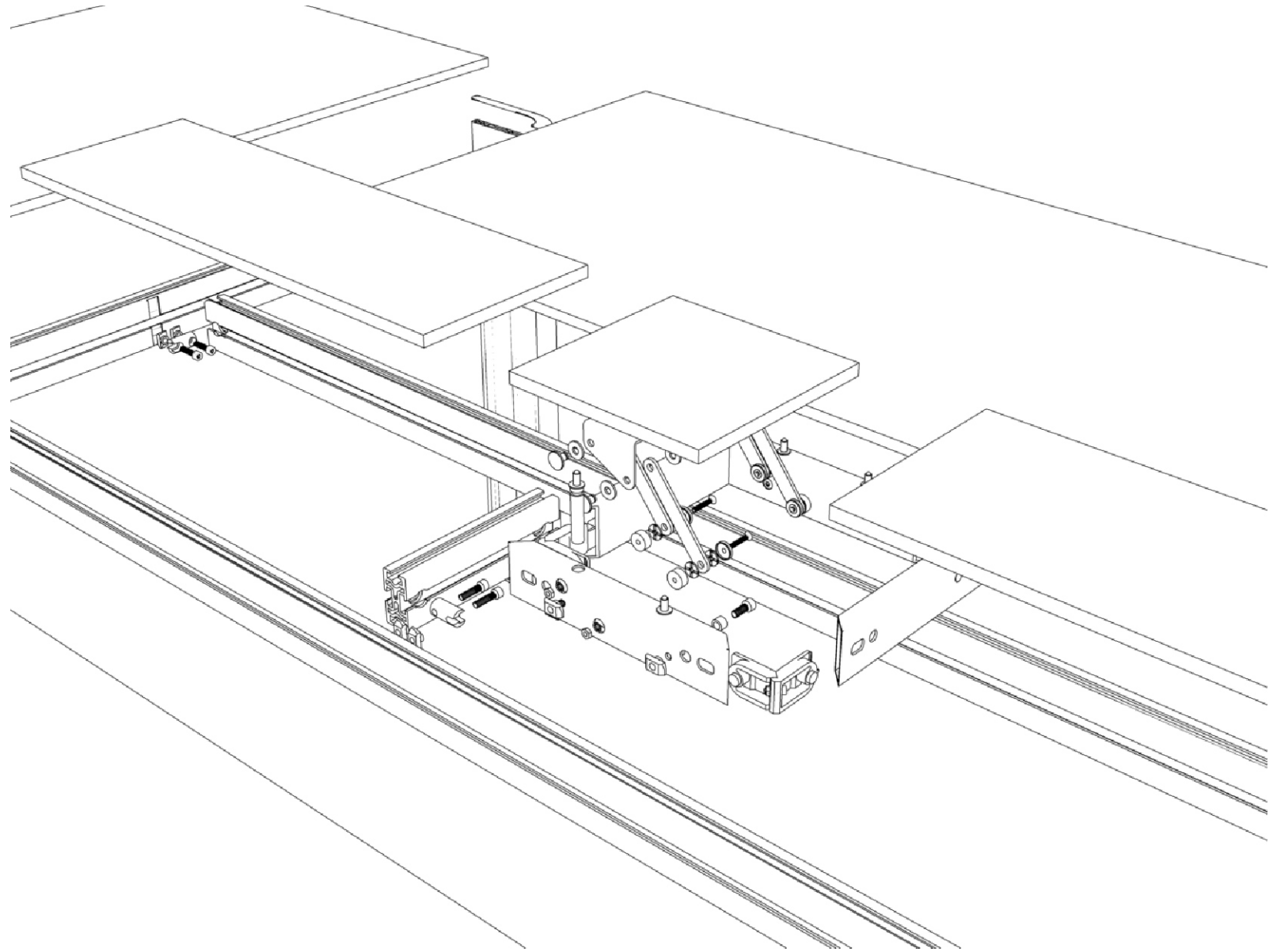

**dodici**<sup>®</sup>

tavoli riunioni  
meeting tables

260 x 140    340 x 180  
400 x 140    520 x 180  
540 x 140    700 x 180

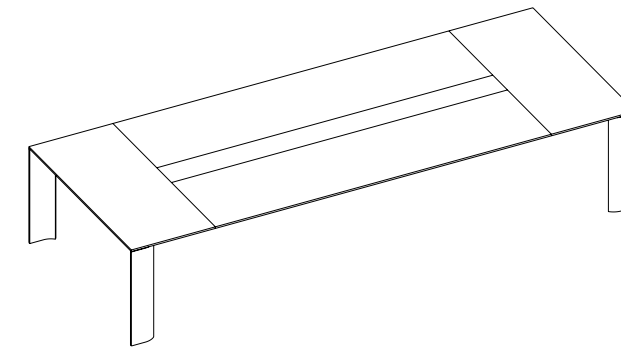

gamba centrale  
central leg

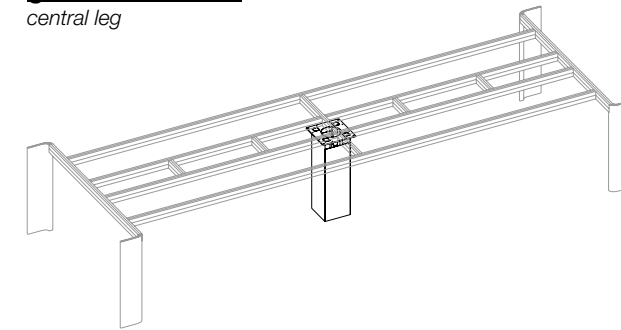

gamba centrale per lunghezze superiori a 340  
central leg for lengths above 340

inserto elettrificato  
wired insert

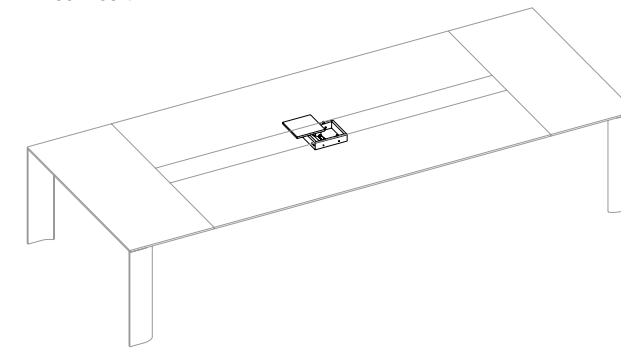

inserto apribile per vaschetta elettrificata  
accessible insert for power connections

inserto fisso  
fixed insert

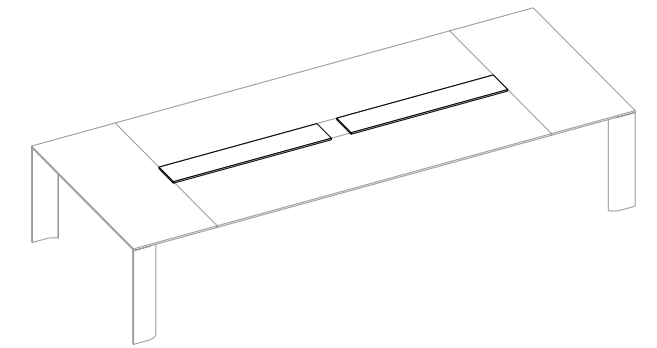

inserto fisso a misura  
cut-to-size fixed insert

accessori  
accessories



vertebra  
vertebra

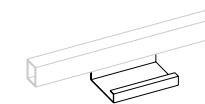

canalina passacavi  
wiring channel



## contenitori

storages

Contenere, racchiudere, custodire, nascondere. Funzioni semplici per elementi di grande valore scenico. **dodici**® assolve alle esigenze di stoccaggio con stile e sobrietà attraverso pochi moduli di contenimento. Due altezze, 80 e 120 cm, due tipologie, ad anta cieca e a giorno. Tutto giocato sulla qualità dei materiali e sul valore estetico delle finiture. Parallelepipedi che completano l'ambiente, con discrezione. Le maniglie, sottili e minimali, esprimono lo spirito della collezione e il fine ultimo del progetto: arredare semplicemente.

*Store, protect, enclose and hide. Simple functions of high aesthetic impact. **dodici**® responds to storage needs with style and class, with only a few storage modules. Two heights, 80 and 120 cm, two series, with and without doors. The character of these units is in the materials and in the finishes. Neat parallelepipeds that complete the ambience. Handles, thin and minimal, express the spirit of this collection and its ultimate purpose: elegance and simplicity in furnishing.*





Piccoli contenitori, cassettiere, mobili di servizio integrati con le scrivanie.  
Volumi sobri per contenere e da contemplare.

Small containers, drawer sets and service tables, all integrated with the desks.  
Sober and practical volumes that please the eye.





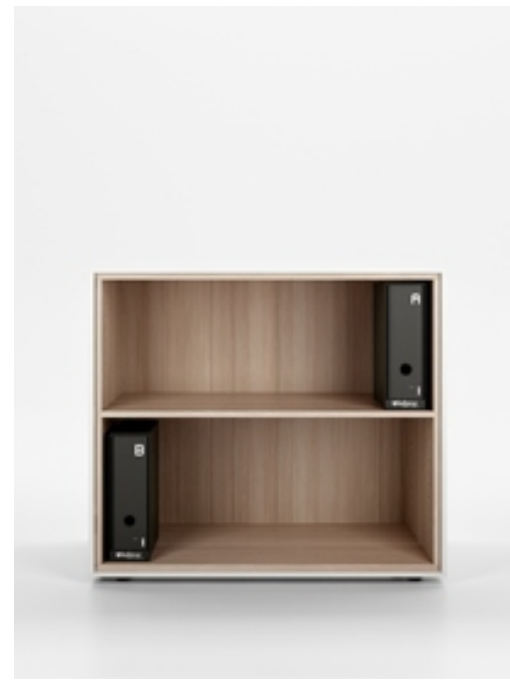

Una doppia struttura per personalizzare ante e cassetti, spazi interni e vani a giorno. Un gioco compositivo studiato per raggiungere piacevoli effetti di contrasto materico.

*A double frame to create customised configurations of doors, drawers, closed storage spaces and open shelves. A composition game that allows a pleasant juxtaposition of different materials.*



contenitori  
storages

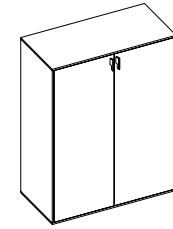
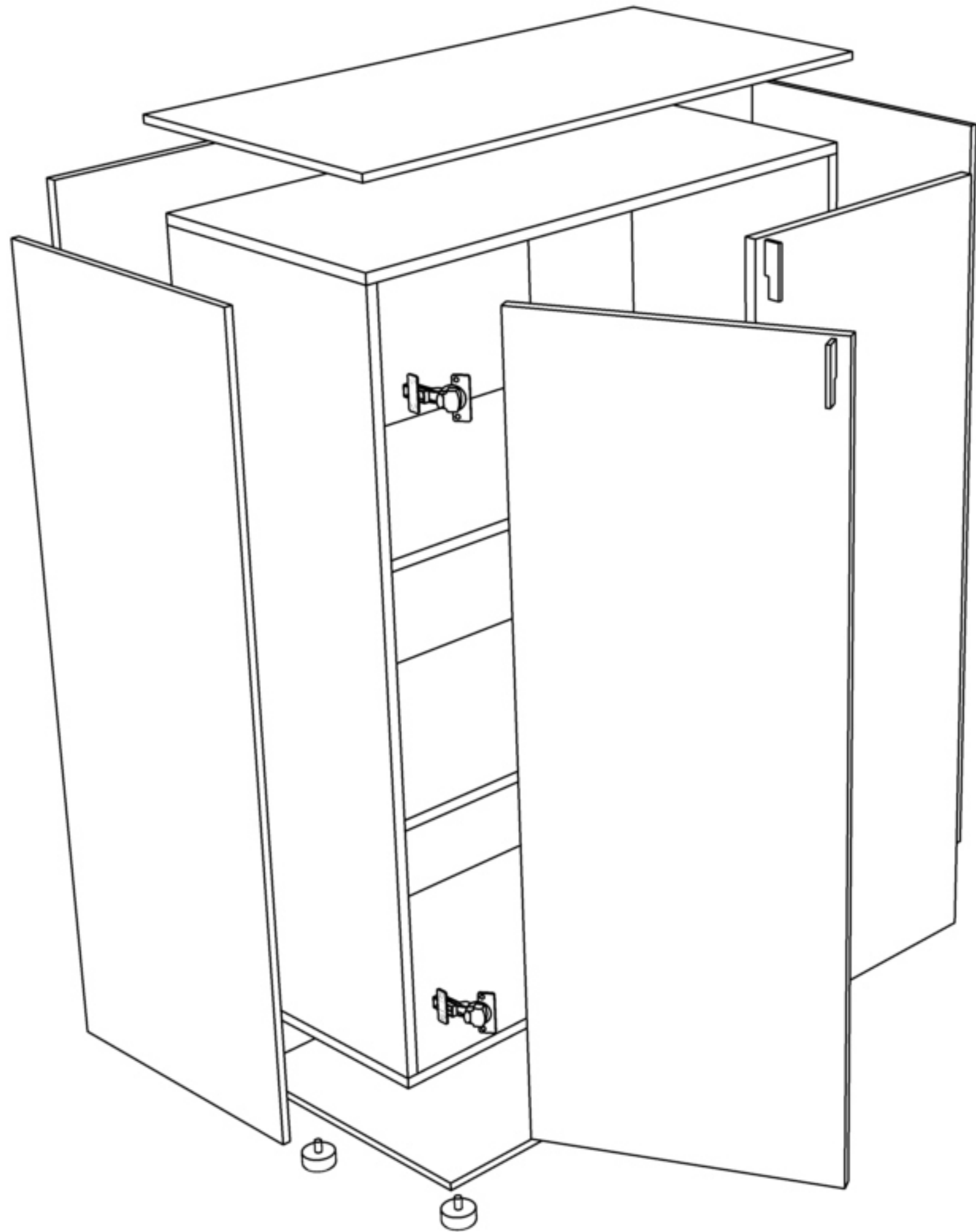

contenitore a 2 ante 90 x 45 h. 120  
two-door cabinet 90 x 45 h. 120

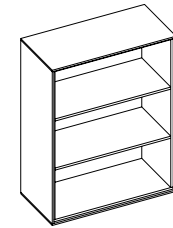

contenitore a giorno 90 x 45 h. 120  
open cabinet 90 x 45 h. 120

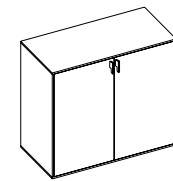

contenitore a 2 ante 90 x 45 h. 80  
two-door cabinet 90 x 45 h. 80

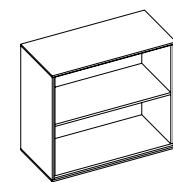

contenitore a giorno 90 x 45 h. 80  
open cabinet 90 x 45 h. 80

cassettiere  
drawers



cassettiera con  
porta cancelleria  
drawer with stationery tray

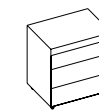

cassettiera con  
3 cassetti  
three-drawer chest





finiture strutture

*structure finishing*

- 001 - anodizzato argento / *silver anodized*
- 033 - anodizzato bronzo / *bronze anodized*
- 008 - verniciato bianco / *white painted*
- 007 - verniciato nero / *black painted*
- 013 - brillantato lucido / *polished*



008



007



001



013

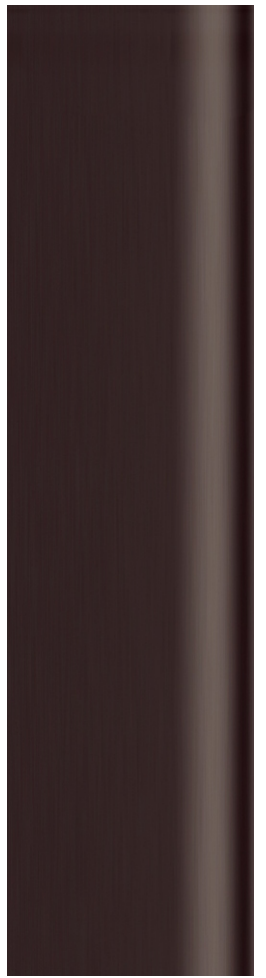

033



finiture piani sp. 12 mm.  
*desk tops finishing sp. 12 mm.*

HPL UNICOLOR / *hpl unicolor*

300 - bianco / *white*  
301 - nero / *black*

VETRO TEMPERATO / *tempered glass*

149 - extrachiaro laccato bianco / *extralight white lacquered*  
150 - extrachiaro satinovo laccato bianco / *extralight satinovo white lacquered*  
151 - extrachiaro laccato cappuccino / *extralight cappuccino lacquered*  
152 - extrachiaro satinovo laccato cappuccino / *extralight satinovo cappuccino lacquered*  
153 - trasparente laccato marrone / *transparent brown lacquered*  
154 - satinovo laccato marrone / *satinovo brown lacquered*  
155 - trasparente laccato nero / *trasparente black lacquered*  
156 - satinovo laccato nero / *satinovo black lacquered*

*hpl / hpl*

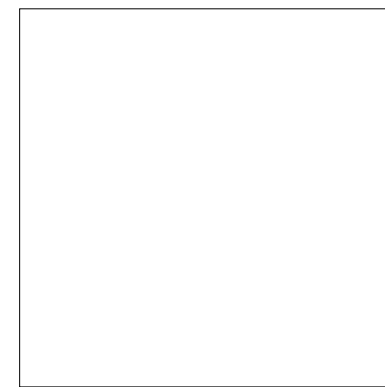

300



301

*vetro / glass*

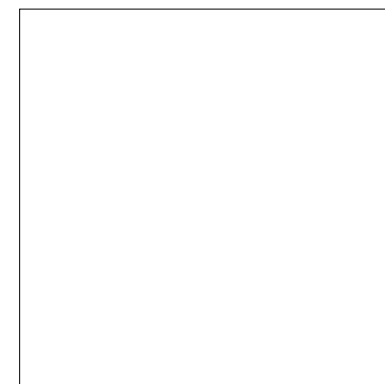

149

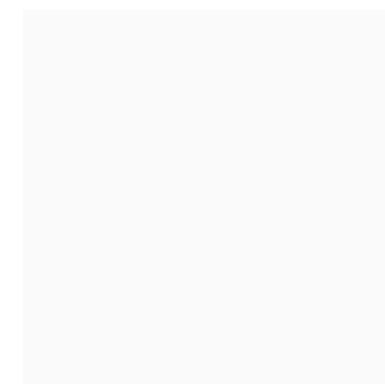

150



151



152

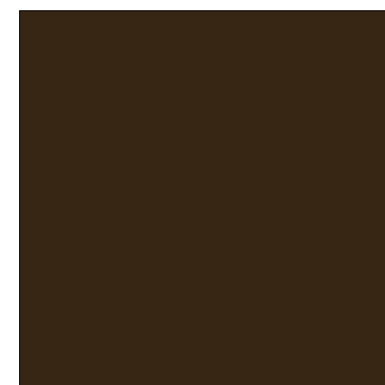

153



154



155



156

finiture piani Sp. 18 mm.  
desk tops finishing sp. 18 mm.

NOBILITATO / melamine

- 014 - bianco liscio / *smooth white*
- 044 - bianco caldo / *warm white*
- 029 - grigio chiaro / *light grey*
- 031 - sabbia / *sand*
- 012 - crema / *cream*
- 304 - bronze maya penelope / *maya bronze penelope*
- 305 - delavè penelope / *delavè penelope*
- 312 - greige penelope / *greige penelope*
- 306 - larice chiaro liscio / *smooth clear larch*
- 307 - larice scuro liscio / *smooth dark larch*
- 308 - noce leuca liscio / *smooth walnut leuca*
- 109 - rovere naturale / *natural oak*
- 050 - rovere chiaro / *light oak*
- 107 - rovere moro / *dark oak*
- 023 - faggio / *beech*
- 003 - acero / *maple*

nobilitato / *melamine*

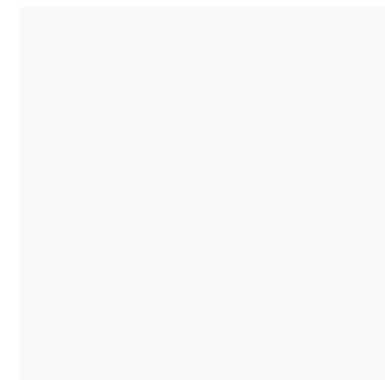

014

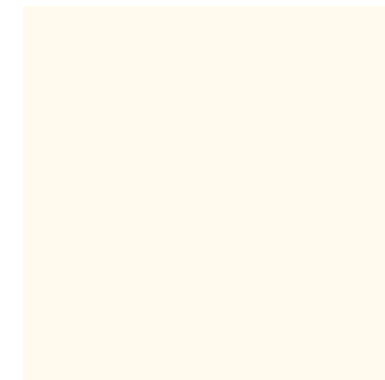

044

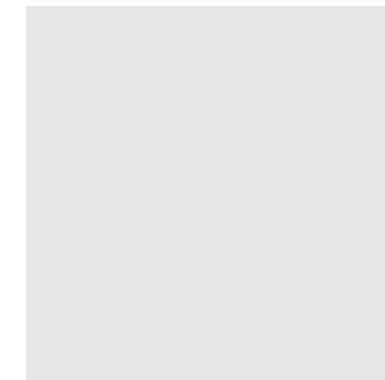

029

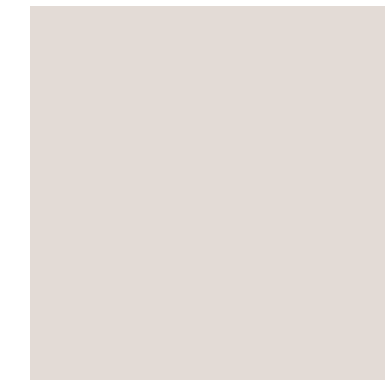

031



012



304



305

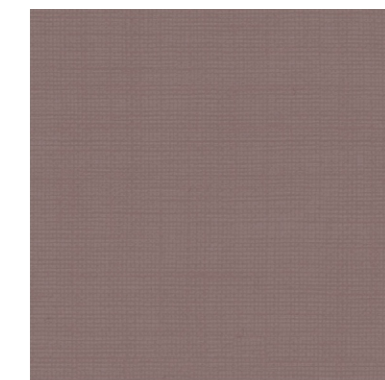

312

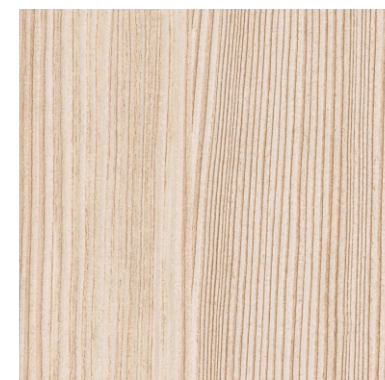

306



307

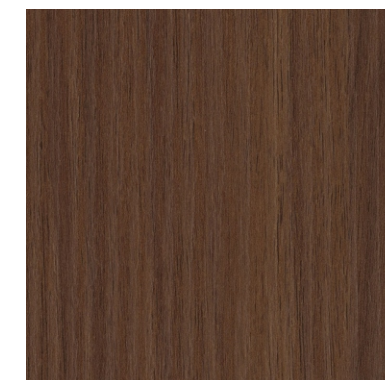

308

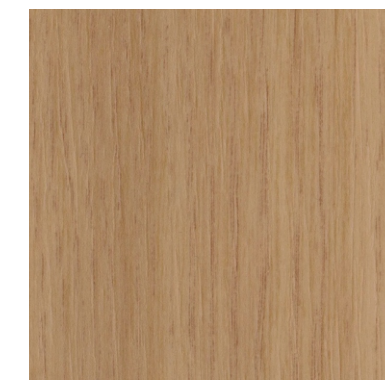

109

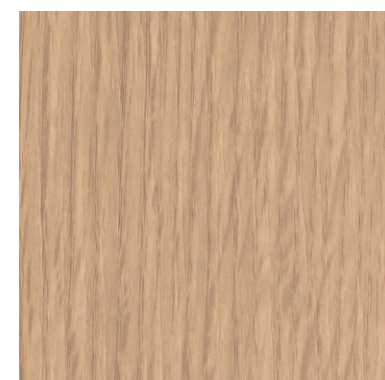

050



107

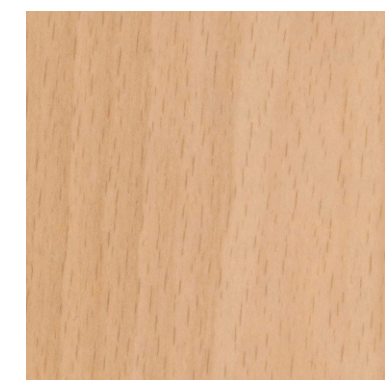

023



003



finiture contenitori  
storage finishing

*STRUTTURA INTERNA IN NOBILITATO sp. 18 mm. / internal structure with 18 mm. melamine*

044 - bianco caldo liscio / smooth warm white  
nnn - nero / black  
306 - larice chiaro liscio / smooth clear larch

*RIVESTIMENTO ESTERNO IN NOBILITATO sp. 18 mm. / external structure with 18 mm. melamine*

044 - bianco caldo liscio / smooth warm white  
108 - bianco caldo finitura 72 / warm white finish. 72  
nnn - nero / black  
304 - bronze maya penelope / maya bronze penelope  
107 - rovere moro / dark oak

nobilitato / melamine

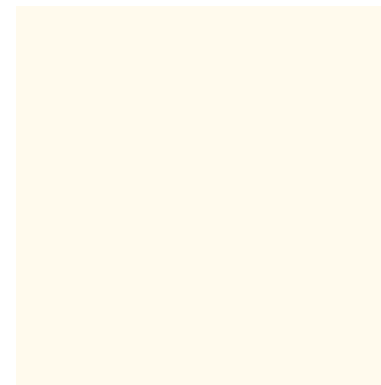

044



nnn

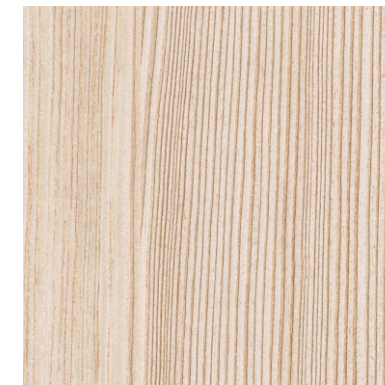

306

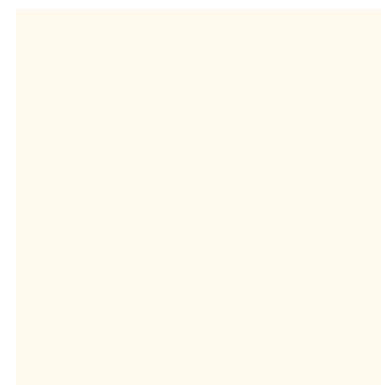

044 / 108



nnn



304

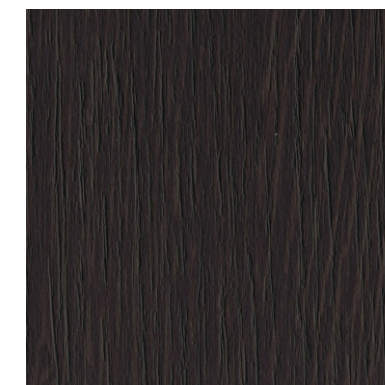

107

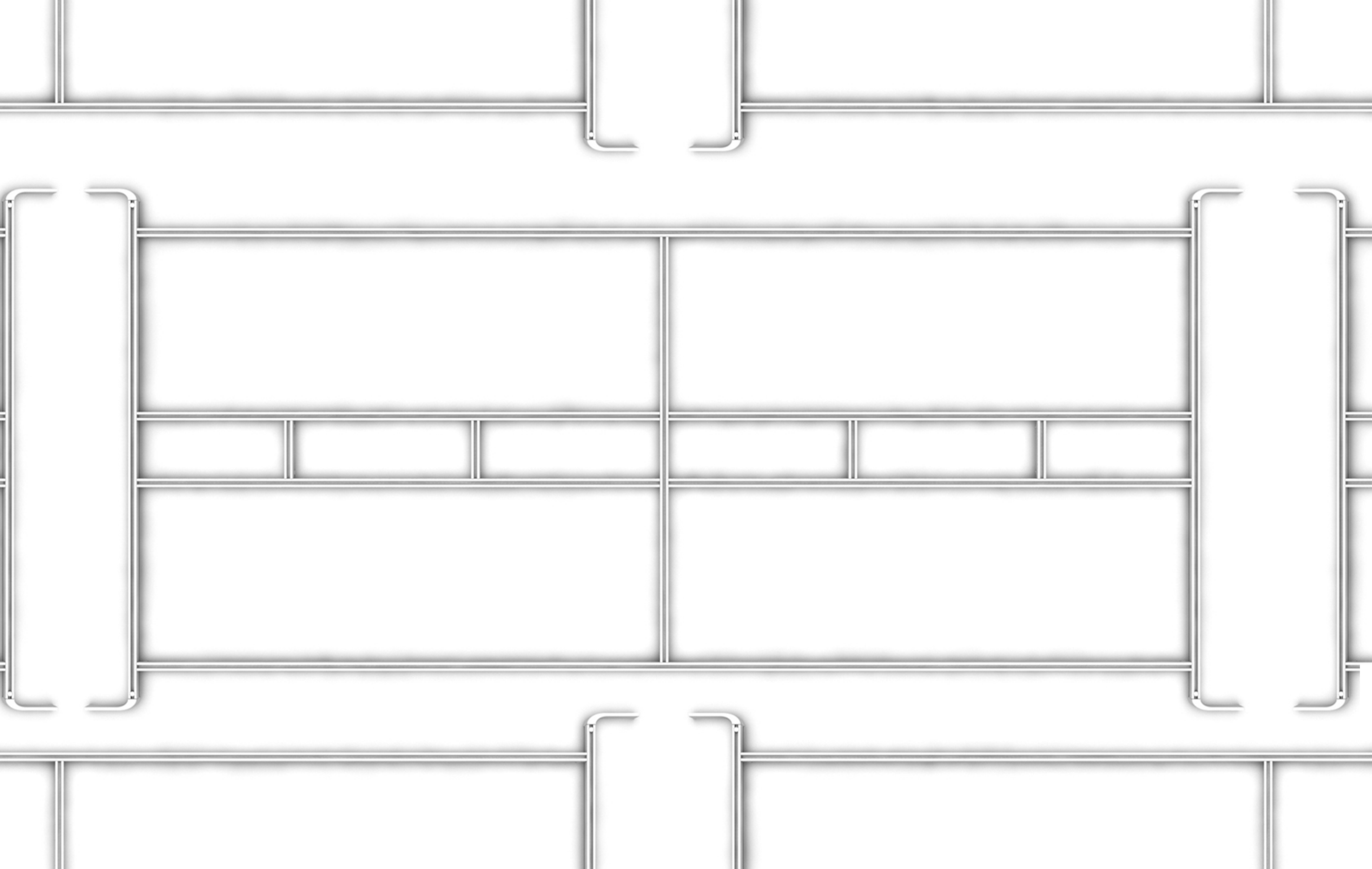



combinazioni  
*configurations*



001 - anodizzato argento + piani sp. 12 mm.  
 001 - silver anodized + desk tops sp.12 mm.



300 - hpl unicolor bianco  
 300 - hpl unicolor white  
 301 - hpl unicolor nero  
 301 - hpl unicolor black  
 149 - extrachiaro laccato bianco  
 149 - extralight white lacquered  
 150 - extrachiaro satinovo laccato bianco  
 150 - extralight satinovo white lacquered



151 - extrachiaro laccato cappuccino  
 151 - extralight cappuccino lacquered  
 152 - x.chiaro satinovo laccato cappuccino  
 152 - x.light satinovo cappuccino lacquered  
 153 - trasparente laccato marrone  
 153 - transparent brown lacquered  
 154 - satinovo laccato marrone  
 154 - satinovo brown lacquered

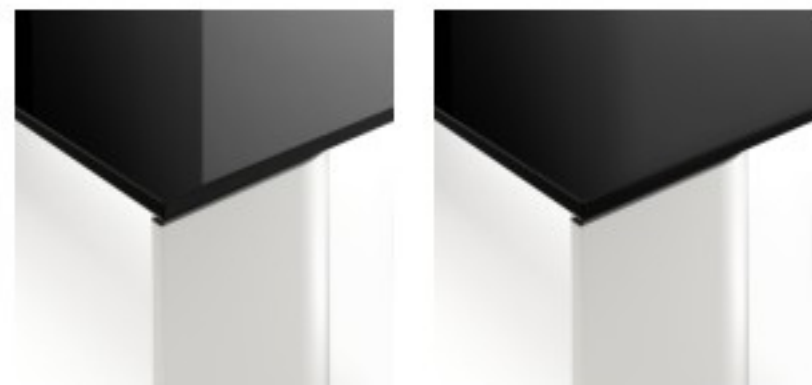

155 - trasparente laccato nero  
 155 - trasparente black lacquered  
 156 - satinovo laccato nero  
 156 - satinovo black lacquered

001 - anodizzato argento + piani sp. 18 mm.  
 001 - silver anodized + desk tops sp.18 mm.



014 - bianco liscio  
 014 - smooth white  
 044 - bianco caldo  
 044 - warm white  
 029 - grigio chiaro  
 029 - light grey  
 031 - sabbia  
 031 - sand



012 - crema  
 012 - cream  
 304 - bronze maya penelope  
 304 - maya bronze penelope  
 305 - delavè penelope  
 305 - delavè penelope  
 312 - greige penelope  
 312 - greige penelope



306 - larice chiaro liscio  
 306 - smooth clear larch  
 307 - larice scuro liscio  
 307 - smooth dark larch  
 308 - noce leuca liscio  
 308 - smooth walnut leuca  
 109 - rovere naturale  
 109 - natural oak



050 - rovere chiaro  
 050 - light oak  
 107 - rovere moro  
 107 - dark oak  
 023 - faggio  
 023 - beech  
 003 - acero  
 003 - maple



033 - anodizzato bronzo + piani sp. 12 mm.  
 033 - bronze anodized + desk tops sp.12 mm.



300 - hpl unicolor bianco  
 300 - hpl unicolor white  
 301 - hpl unicolor nero  
 301 - hpl unicolor black  
 149 - extrachiaro laccato bianco  
 149 - extralight white lacquered  
 150 - extrachiaro satinovo laccato bianco  
 150 - extralight satinovo white lacquered



151 - extrachiaro laccato cappuccino  
 151 - extralight cappuccino lacquered  
 152 - x.chiaro satinovo laccato cappuccino  
 152 - x.light satinovo cappuccino lacquered  
 153 - trasparente laccato marrone  
 153 - transparent brown lacquered  
 154 - satinovo laccato marrone  
 154 - satinovo brown lacquered



155 - trasparente laccato nero  
 155 - trasparente black lacquered  
 156 - satinovo laccato nero  
 156 - satinovo black lacquered

033 - anodizzato bronzo + piani sp. 18 mm.  
 033 - bronze anodized + desk tops sp.18 mm.

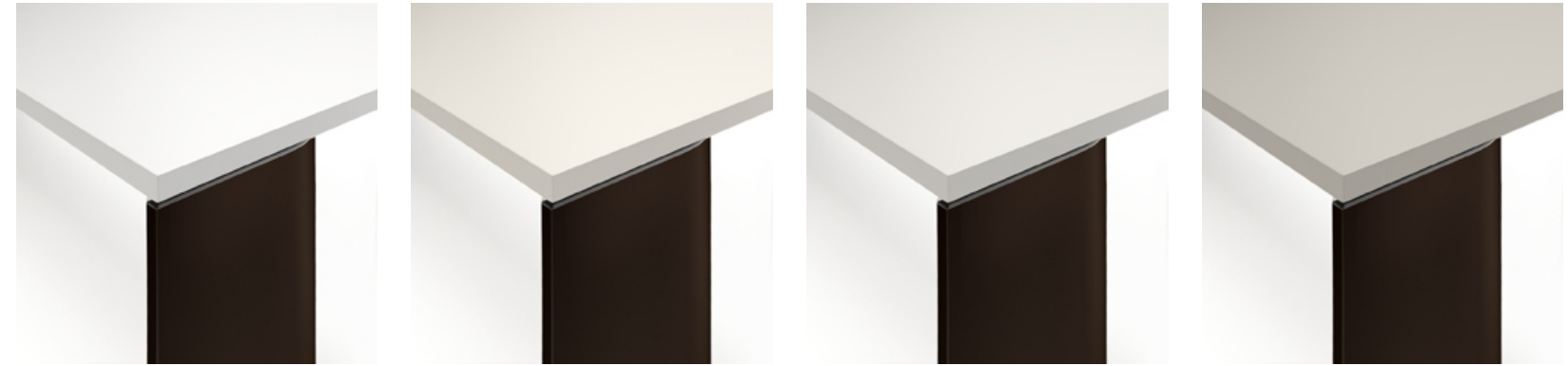

014 - bianco liscio  
 014 - smooth white  
 044 - bianco caldo  
 044 - warm white  
 029 - grigio chiaro  
 029 - light grey  
 031 - sabbia  
 031 - sand



012 - crema  
 012 - cream  
 304 - bronze maya penelope  
 304 - maya bronze penelope  
 305 - delavè penelope  
 305 - delavè penelope  
 312 - greige penelope  
 312 - greige penelope



306 - larice chiaro liscio  
 306 - smooth clear larch  
 307 - larice scuro liscio  
 307 - smooth dark larch  
 308 - noce leuca liscio  
 308 - smooth walnut leuca  
 109 - rovere naturale  
 109 - natural oak



050 - rovere chiaro  
 050 - light oak  
 107 - rovere moro  
 107 - dark oak  
 023 - faggio  
 023 - beech  
 003 - acero  
 003 - maple

008 - verniciato bianco + piani sp. 12 mm.  
 008 - white painted + desk tops sp.12 mm.



300 - hpl unicolor bianco  
 300 - hpl unicolor white  
 301 - hpl unicolor nero  
 301 - hpl unicolor black  
 149 - extrachiaro laccato bianco  
 149 - extralight white lacquered  
 150 - extrachiaro satinovo laccato bianco  
 150 - extralight satinovo white lacquered



151 - extrachiaro laccato cappuccino  
 151 - extralight cappuccino lacquered  
 152 - x.chiaro satinovo laccato cappuccino  
 152 - x.light satinovo cappuccino lacquered  
 153 - trasparente laccato marrone  
 153 - transparent brown lacquered  
 154 - satinovo laccato marrone  
 154 - satinovo brown lacquered



155 - trasparente laccato nero  
 155 - trasparente black lacquered  
 156 - satinovo laccato nero  
 156 - satinovo black lacquered

008 - verniciato bianco + piani sp. 18 mm.  
 008 - white painted + desk tops sp.18 mm.



014 - bianco liscio  
 014 - smooth white  
 044 - bianco caldo  
 044 - warm white  
 029 - grigio chiaro  
 029 - light grey  
 031 - sabbia  
 031 - sand



012 - crema  
 012 - cream  
 304 - bronze maya penelope  
 304 - maya bronze penelope  
 305 - delavè penelope  
 305 - delavè penelope  
 312 - greige penelope  
 312 - greige penelope



306 - larice chiaro liscio  
 306 - smooth clear larch  
 307 - larice scuro liscio  
 307 - smooth dark larch  
 308 - noce leuca liscio  
 308 - smooth walnut leuca  
 109 - rovere naturale  
 109 - natural oak



050 - rovere chiaro  
 050 - light oak  
 107 - rovere moro  
 107 - dark oak  
 023 - faggio  
 023 - beech  
 003 - acero  
 003 - maple



007 - verniciato nero + piani sp. 12 mm.  
 007 - black panted + desk tops sp.12 mm.



300 - hpl unicolor bianco  
 300 - hpl unicolor white  
 301 - hpl unicolor nero  
 301 - hpl unicolor black  
 149 - extrachiaro laccato bianco  
 149 - extralight white lacquered  
 150 - extrachiaro satinovo laccato bianco  
 150 - extralight satinovo white lacquered

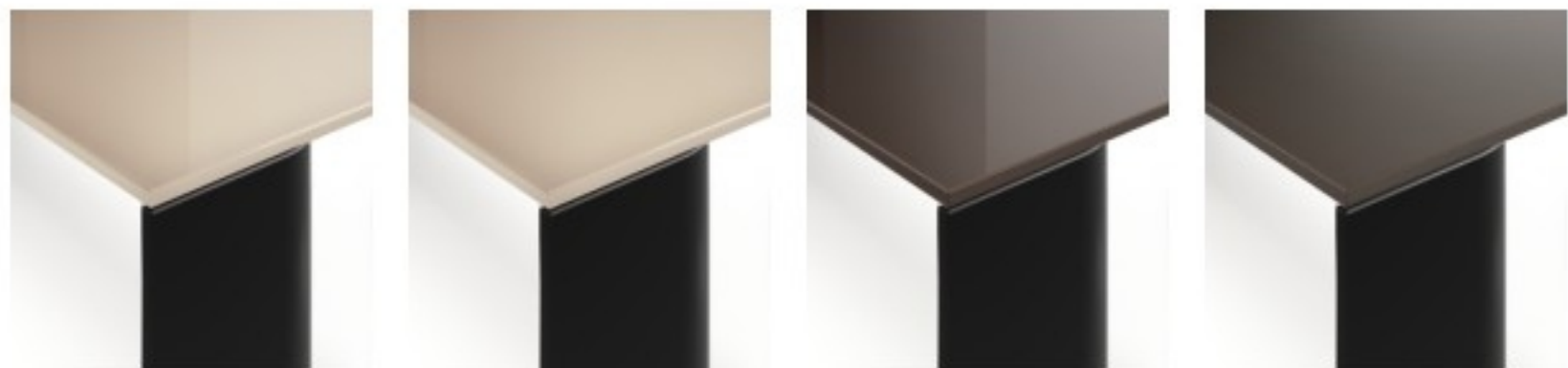

151 - extrachiaro laccato cappuccino  
 151 - extralight cappuccino lacquered  
 152 - x.chiaro satinovo laccato cappuccino  
 152 - x.light satinovo cappuccino lacquered  
 153 - trasparente laccato marrone  
 153 - transparent brown lacquered  
 154 - satinovo laccato marrone  
 154 - satinovo brown lacquered



155 - trasparente laccato nero  
 155 - trasparente black lacquered  
 156 - satinovo laccato nero  
 156 - satinovo black lacquered

007 - verniciato nero + piani sp. 18 mm.  
 007 - black panted + desk tops sp.18 mm.

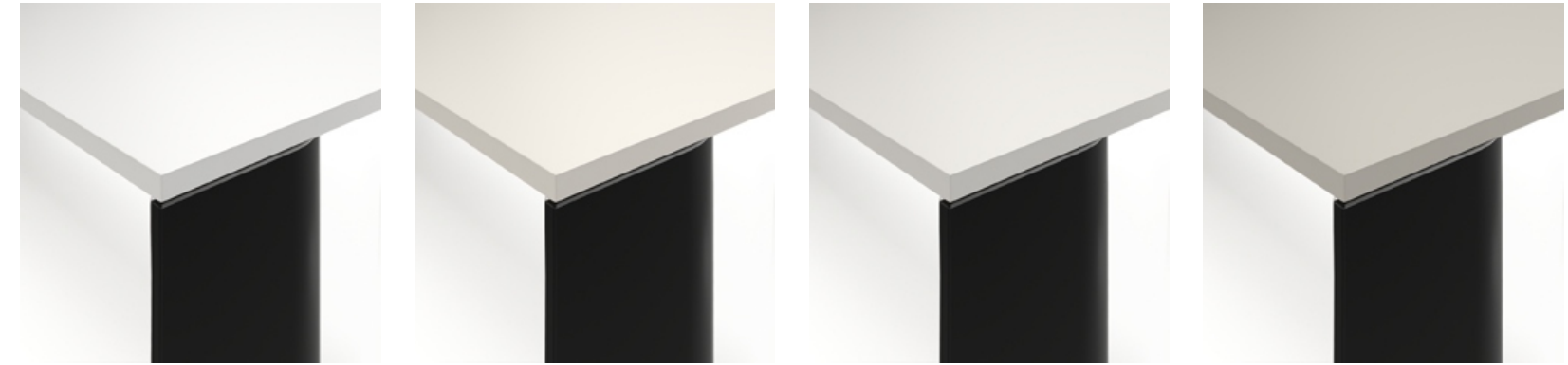

014 - bianco liscio  
 014 - smooth white  
 044 - bianco caldo  
 044 - warm white  
 029 - grigio chiaro  
 029 - light grey  
 031 - sabbia  
 031 - sand



012 - crema  
 012 - cream  
 304 - bronze maya penelope  
 304 - maya bronze penelope  
 305 - delavè penelope  
 305 - delavè penelope  
 312 - greige penelope  
 312 - greige penelope



306 - larice chiaro liscio  
 306 - smooth clear larch  
 307 - larice scuro liscio  
 307 - smooth dark larch  
 308 - noce leuca liscio  
 308 - smooth walnut leuca  
 109 - rovere naturale  
 109 - natural oak



050 - rovere chiaro  
 050 - light oak  
 107 - rovere moro  
 107 - dark oak  
 023 - faggio  
 023 - beech  
 003 - acero  
 003 - maple

013 - brillantato lucido + piani sp. 12 mm.  
 013 - polished + desk tops sp.12 mm.



300 - hpl unicolor bianco  
 300 - hpl unicolor white  
 301 - hpl unicolor nero  
 301 - hpl unicolor black  
 149 - extrachiaro laccato bianco  
 149 - extralight white lacquered  
 150 - extrachiaro satinovo laccato bianco  
 150 - extralight satinovo white lacquered



151 - extrachiaro laccato cappuccino  
 151 - extralight cappuccino lacquered  
 152 - x.chiaro satinovo laccato cappuccino  
 152 - x.light satinovo cappuccino lacquered  
 153 - trasparente laccato marrone  
 153 - transparent brown lacquered  
 154 - satinovo laccato marrone  
 154 - satinovo brown lacquered

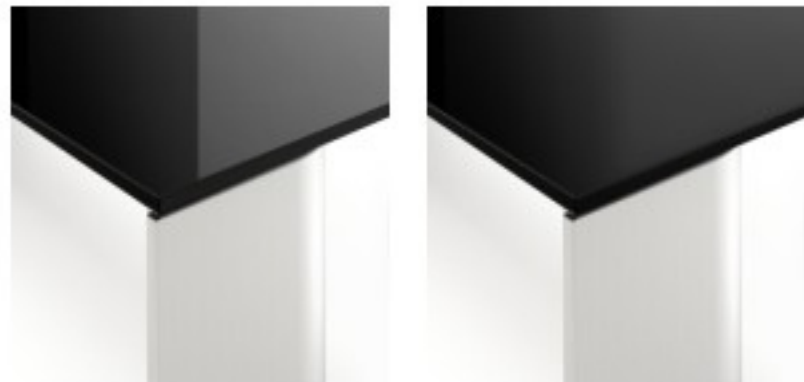

155 - trasparente laccato nero  
 155 - trasparente black lacquered  
 156 - satinovo laccato nero  
 156 - satinovo black lacquered

013 - brillantato lucido + piani sp. 18 mm.  
 013 - polished + desk tops sp.18 mm.



014 - bianco liscio  
 014 - smooth white  
 044 - bianco caldo  
 044 - warm white  
 029 - grigio chiaro  
 029 - light grey  
 031 - sabbia  
 031 - sand



012 - crema  
 012 - cream  
 304 - bronze maya penelope  
 304 - maya bronze penelope  
 305 - delavè penelope  
 305 - delavè penelope  
 312 - greige penelope  
 312 - greige penelope



306 - larice chiaro liscio  
 306 - smooth clear larch  
 307 - larice scuro liscio  
 307 - smooth dark larch  
 308 - noce leuca liscio  
 308 - smooth walnut leuca  
 109 - rovere naturale  
 109 - natural oak



050 - rovere chiaro  
 050 - light oak  
 107 - rovere moro  
 107 - dark oak  
 023 - faggio  
 023 - beech  
 003 - acero  
 003 - maple



