

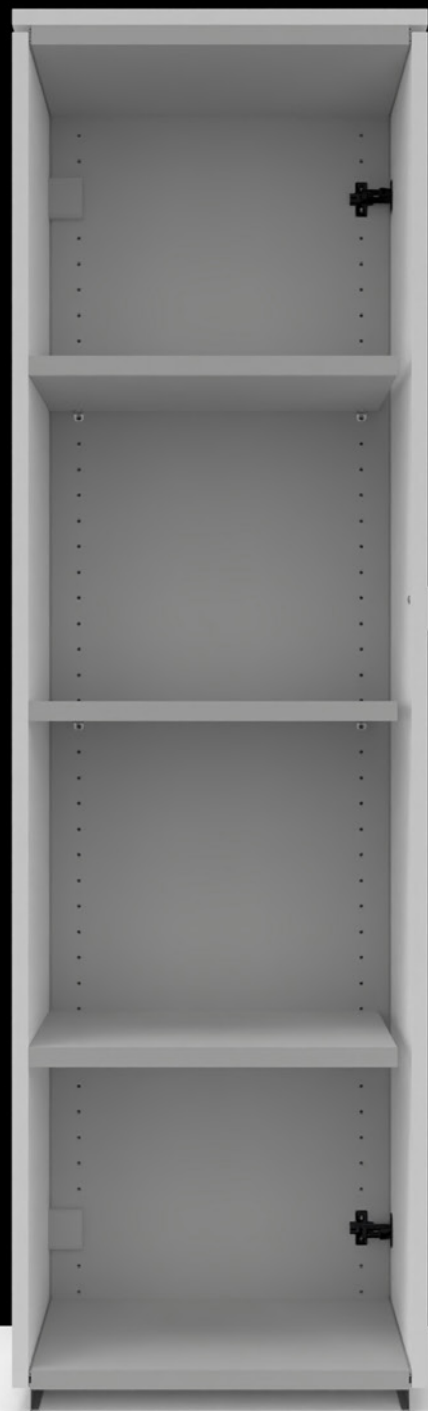

☐ ETOILE

QUADRA[®] SOLID





- 01.** 3 profondità - 600, 462 e 366 mm
- 02.** 2 larghezze - 500 e 1000 mm
- 03.** Struttura a spalla portante in pannelli nobilitati - spessore 22 mm
- 04.** Schienali e fianchi di finitura in pannelli nobilitati, impiallacciati o laccati - spessore 18 mm
- 05.** Ante cieche in legno nobilitato - spessore 18 mm
- 06.** Profilo di tamponamento inferiore e superiore in alluminio
- 07.** Cablaggio nella base inferiore
- 08.** Ripiani interni in nobilitato o metallo
- 09.** Aste appendiabiti
- 10.** Cassetti e porta cartelle estraibili
- 11.** Ante a tutta altezza e vani a giorno
- 12.** Profilo cremagliera in alluminio o foratura passo 32 mm per la regolazione dei piani in altezza
- 13.** Contenitori integrabili con tutte le pareti divisorie

- 01.** Ante cieche - **39 dB**
- 02.** Ante cieche + materiale cartaceo interno - **44 dB**
- 03.** Ante cieche + cassette - **37 dB**
- 04.** Ante cieche + cassette + materiale cartaceo interno **41 dB**
- 05.** Ante cieche + Metrica Solid con isolante - **61 dB**
- 06.** Ante cieche + cassette + Metrica Solid con isolante - **57 dB**
- 07.** Ante cieche + cassette + materiale cartaceo + Metrica Solid con isolante - **58 dB**



Partenze

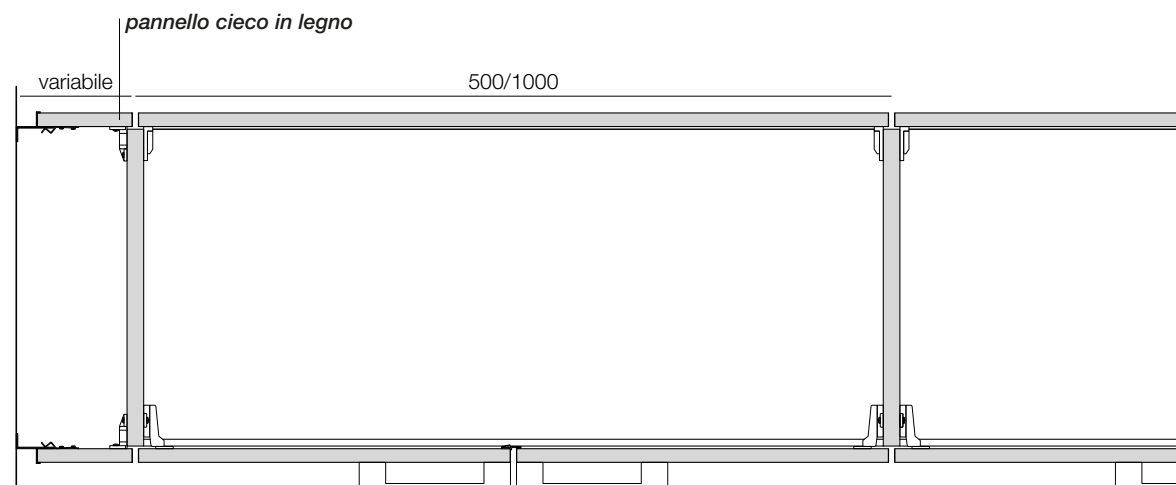
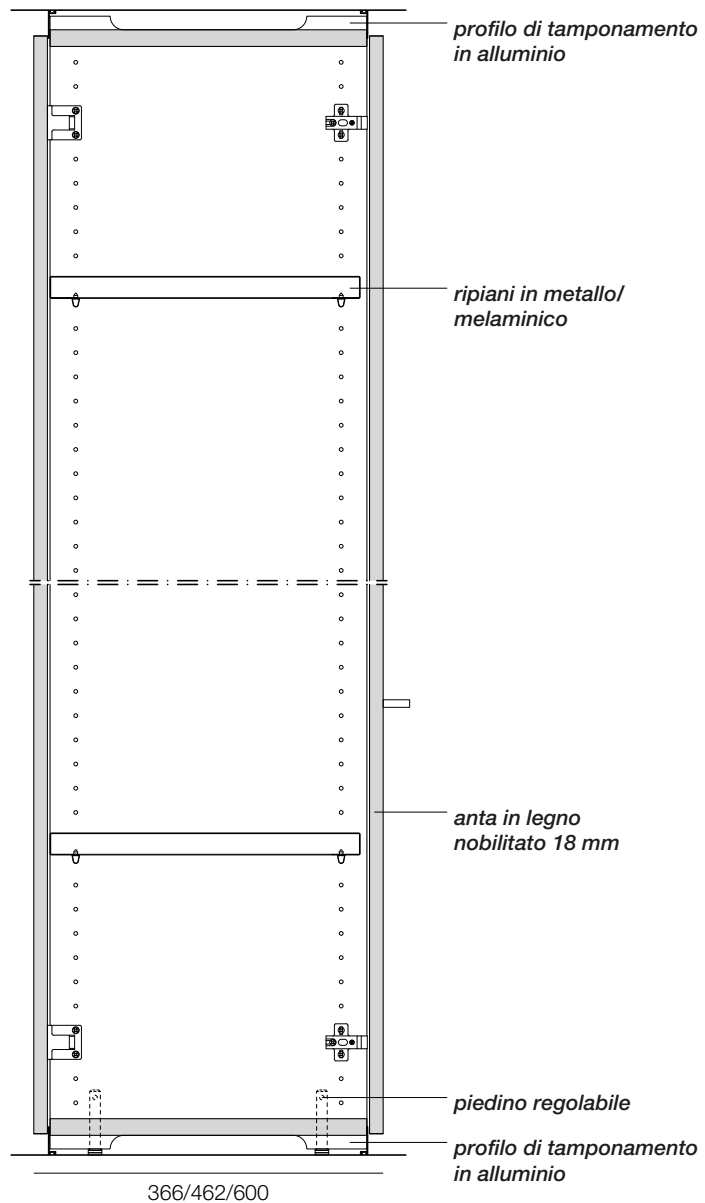

Partenza da parete con pannello di compensazione

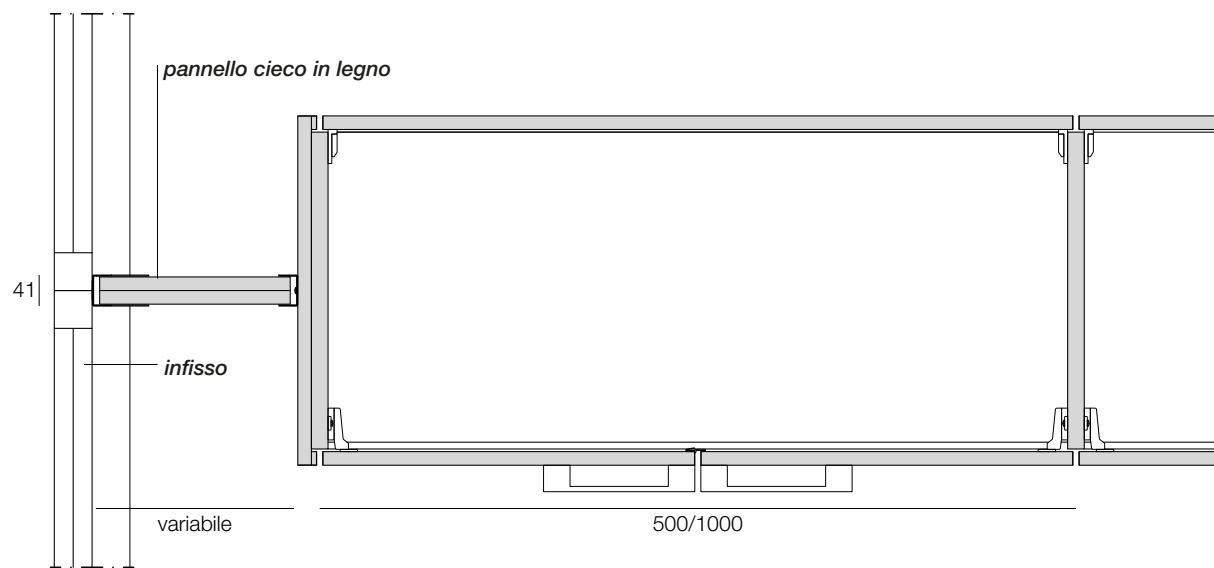

Partenza da parete

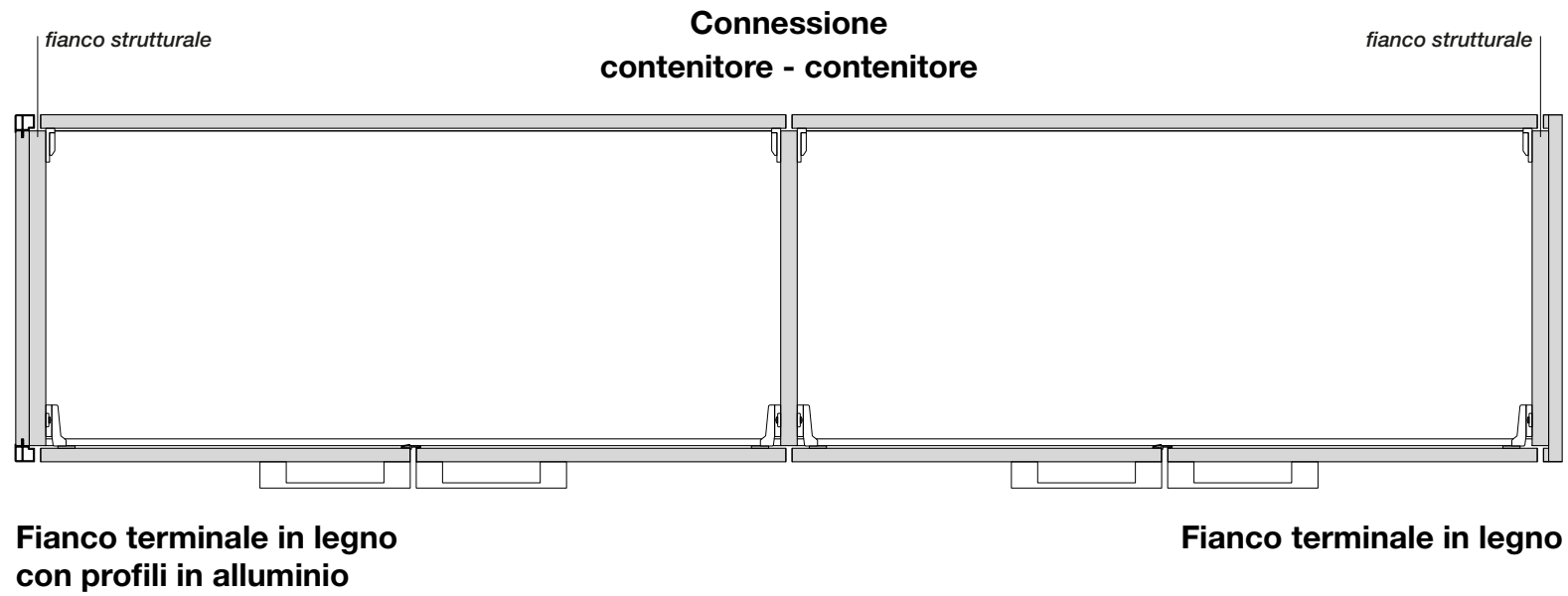

Connessioni lineari



**connessioni valide
per tutte le metriche strutturali e metrica d*

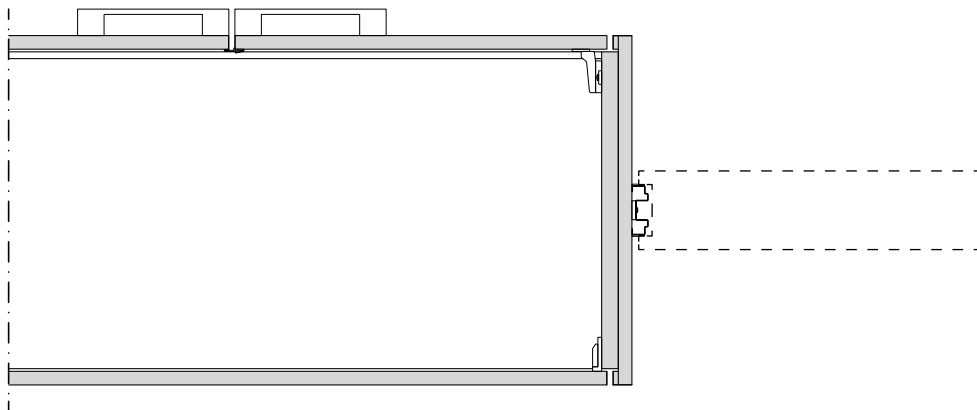

Connessione centrale con metrica

**connessioni valide
per tutte le metriche f*

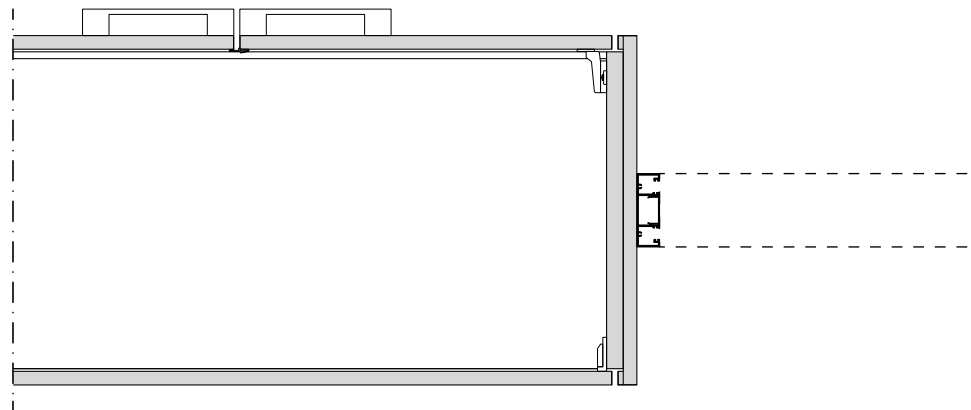

Connessione centrale con metrica f

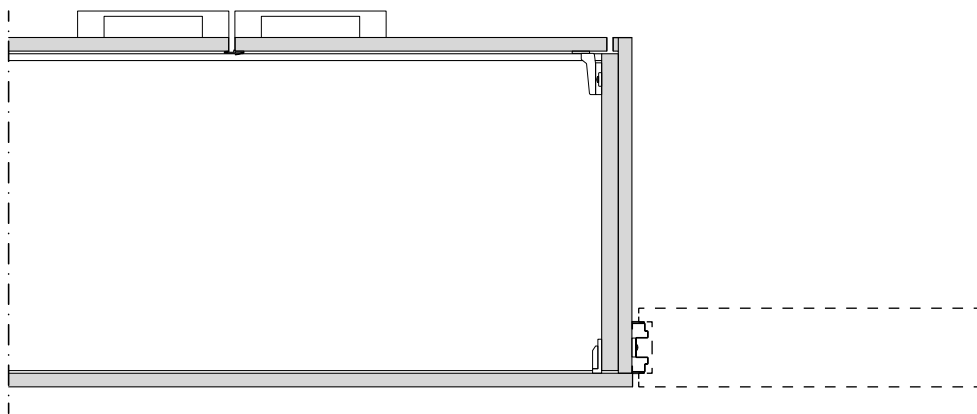

Connessione a correre con metrica

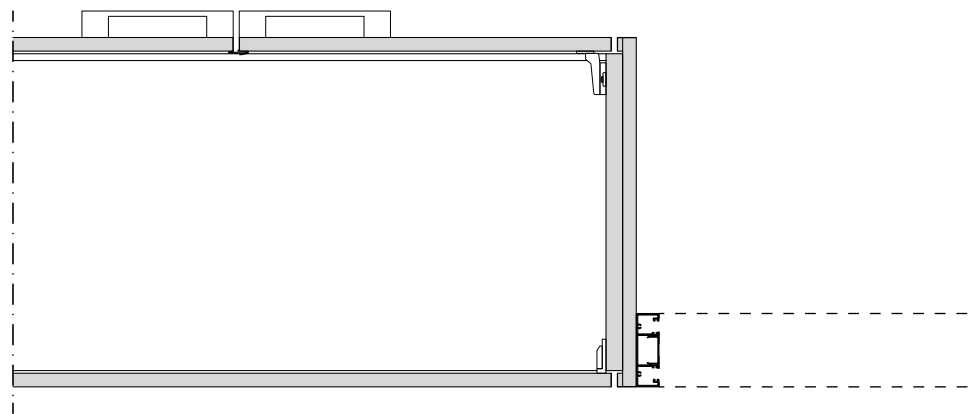

Connessione a correre con metrica f

Connessioni lineari



**connessioni valide
per tutte le ritmica*

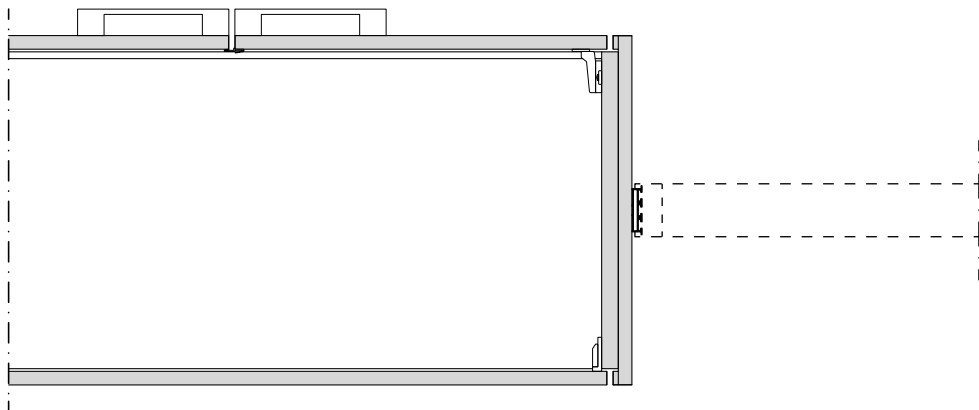

Connessione centrale con ritmica

**connessioni valide
per tutte le ritmica wood*

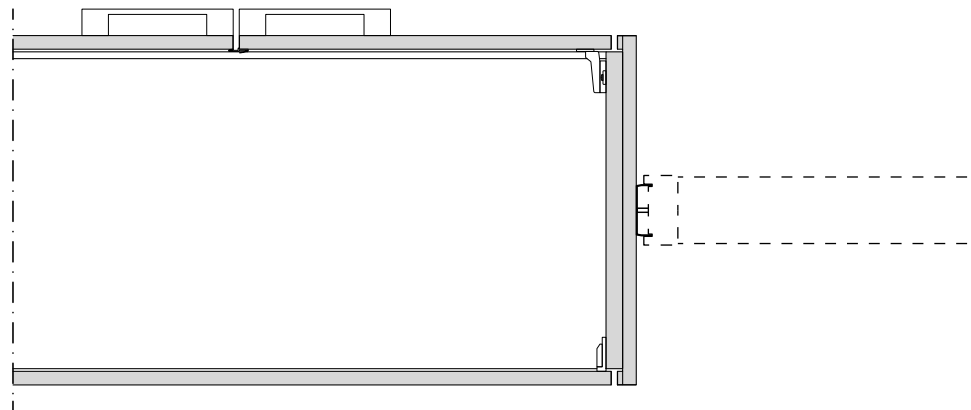

Connessione centrale con ritmica wood

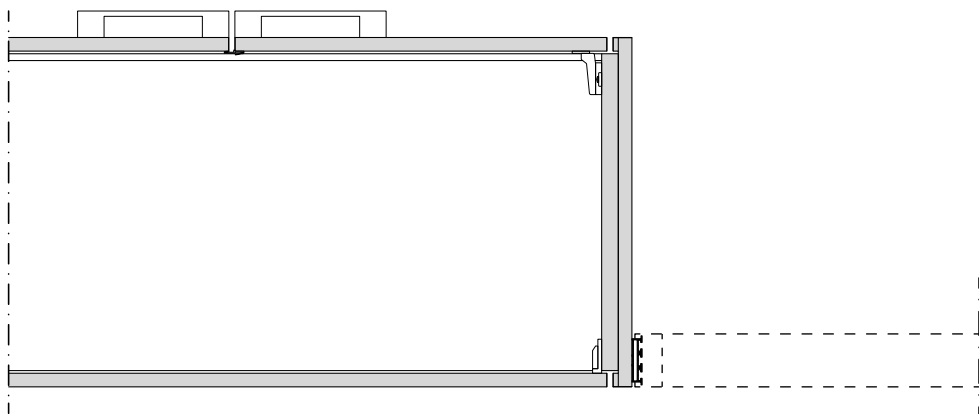

Connessione a correre con ritmica

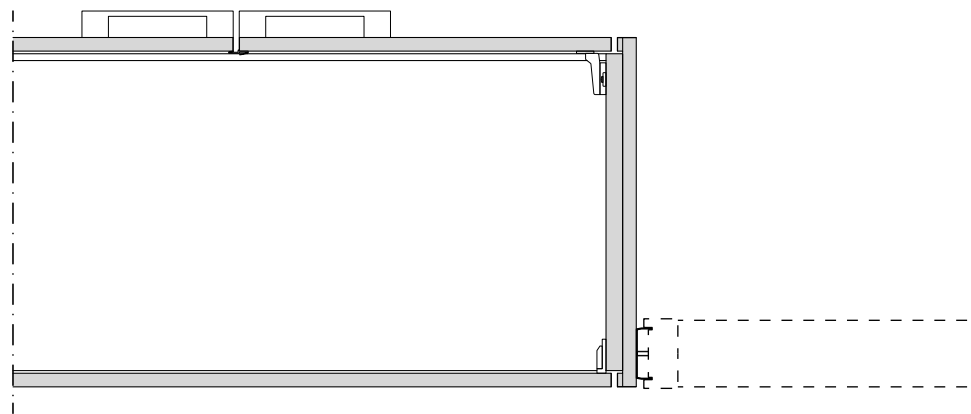

Connessione a correre con ritmica wood

Connessioni lineari



**connessioni valide
per tutte le uniche monovetro*

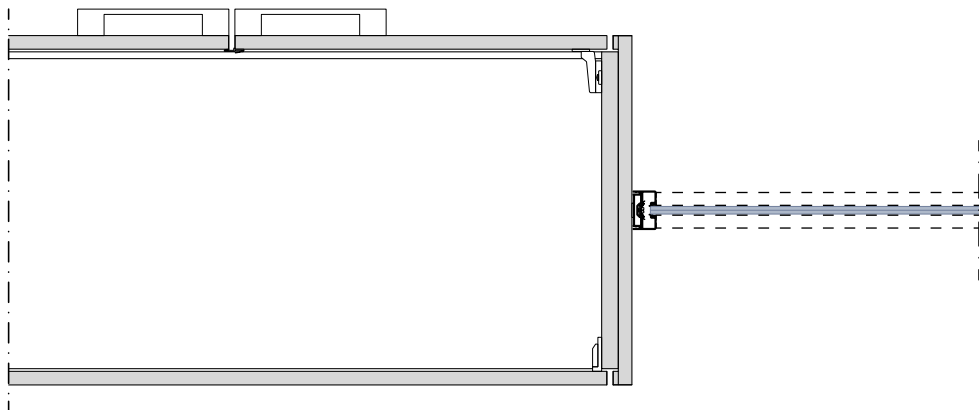

Connessione centrale con unica

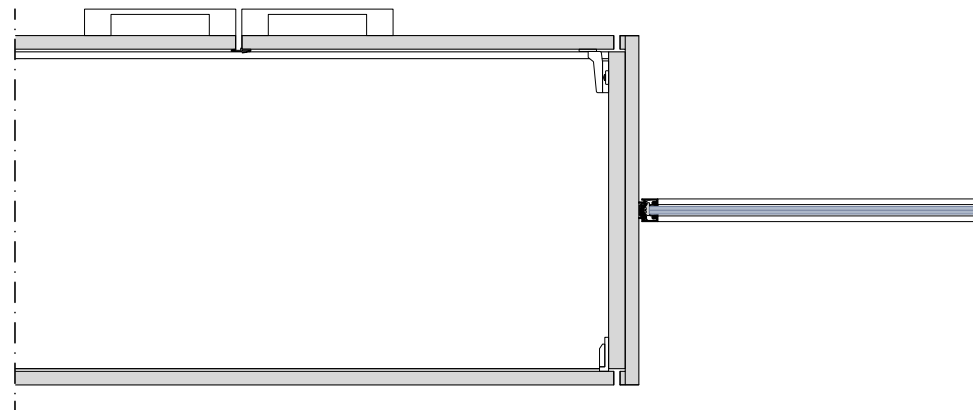

Connessione centrale con unica slim

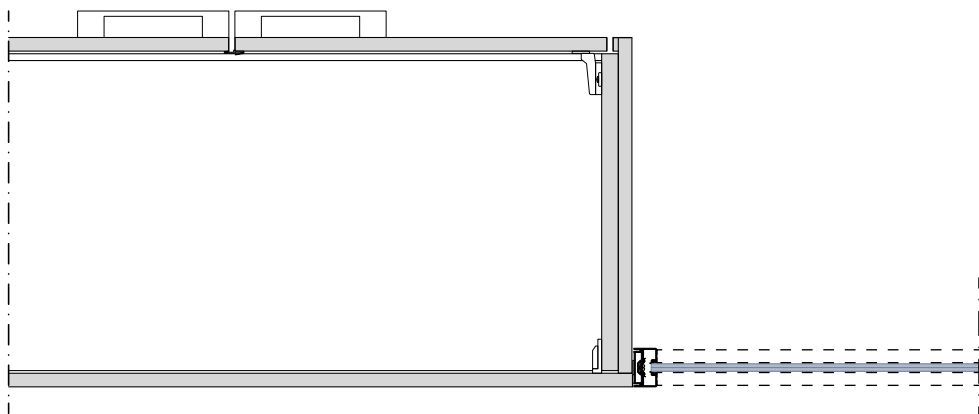

Connessione a correre con unica

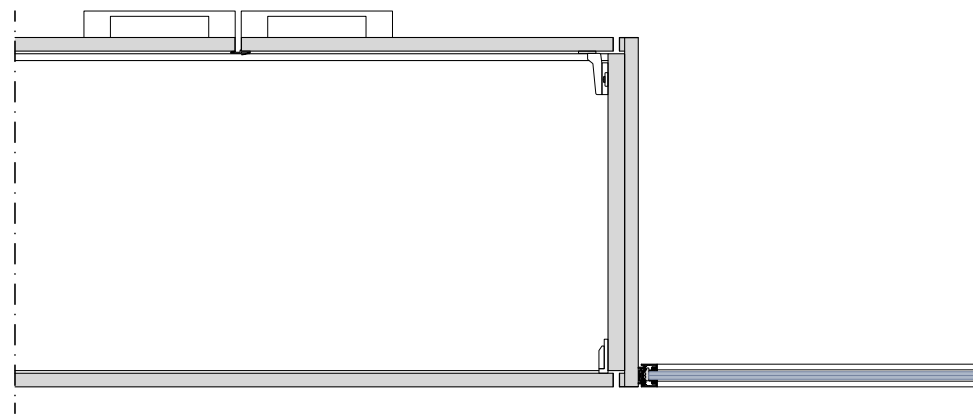

Connessione a correre con unica slim

Connessioni lineari

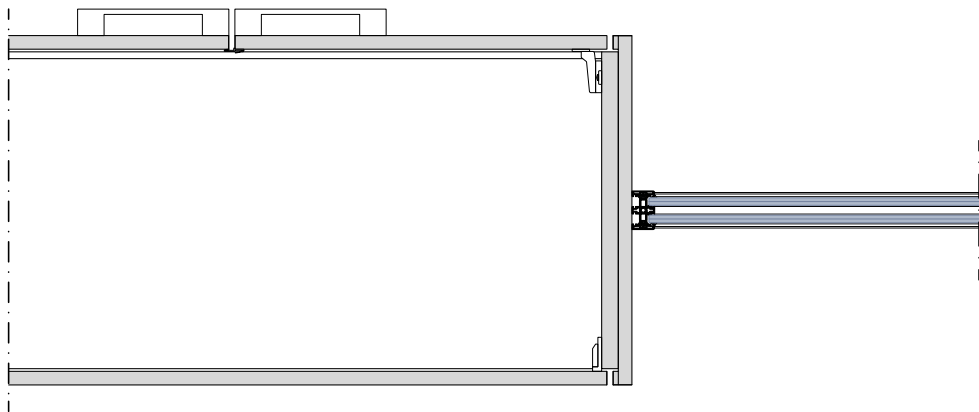

Connessione centrale con unica d

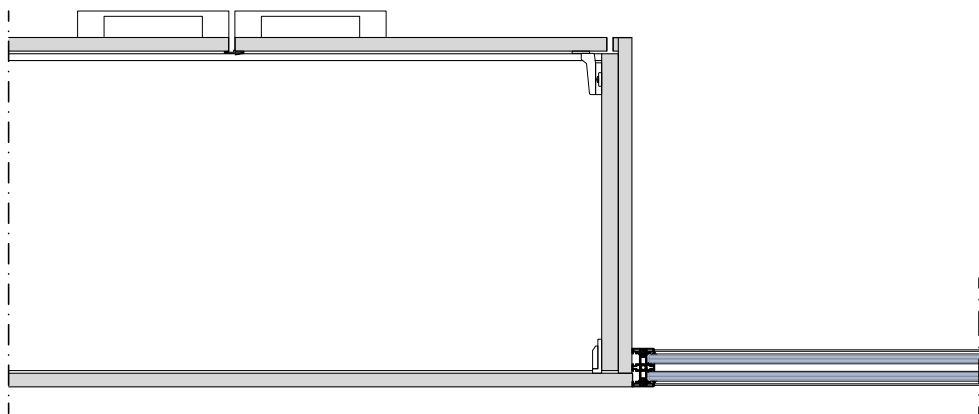

Connessione a correre con unica d

Connessioni lineari



**connessione valida
per tutte le unica monovetro*

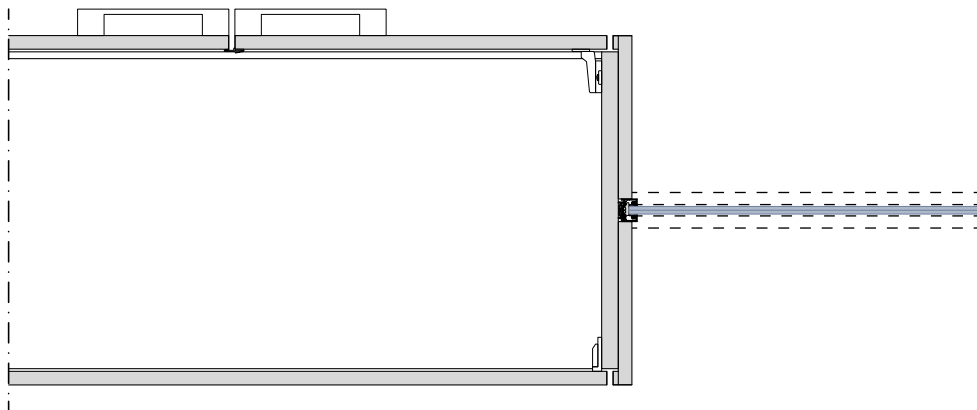

Connessione centrale con unica incassata

**connessioni valide
per tutte le metrica f*

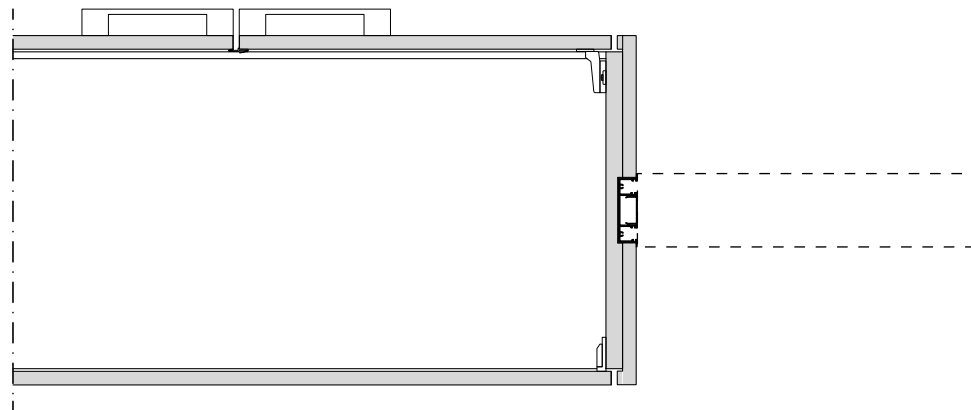

Connessione centrale con metrica f incassata

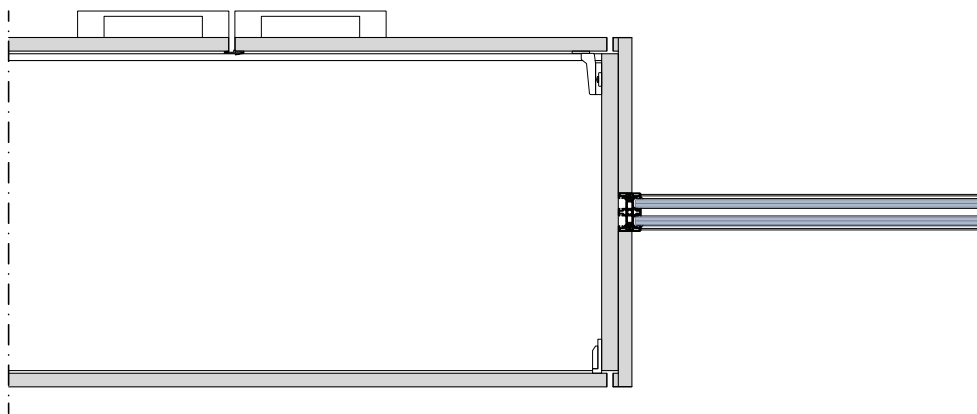

Connessione centrale con unica d incassata



**Connessione a 3 vie
con metrica**

**Connessione a 3 vie
con contenitore**

**Connessione a 3 vie
con metrica f**

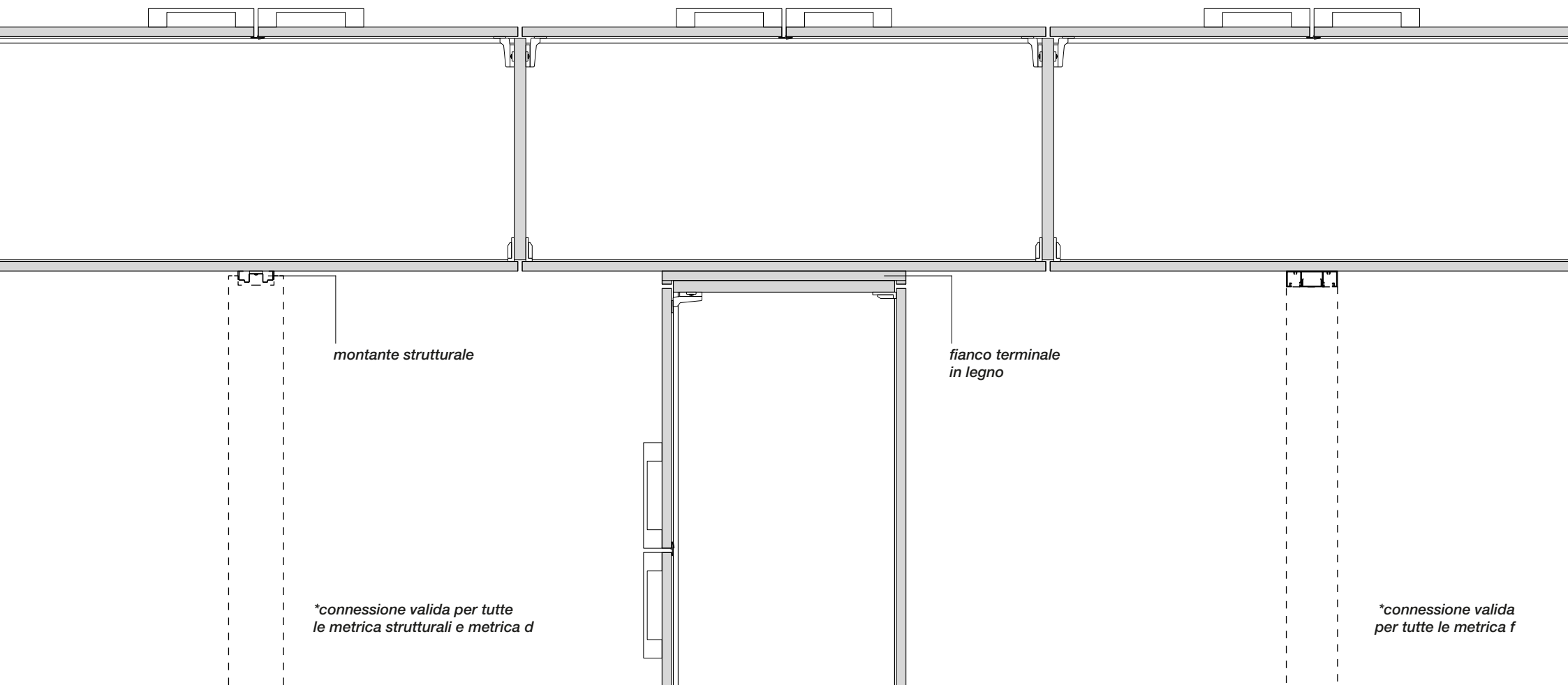



**Connessione a 3 vie
con ritmica**

**Connessione a 3 vie
con ritmica wood**

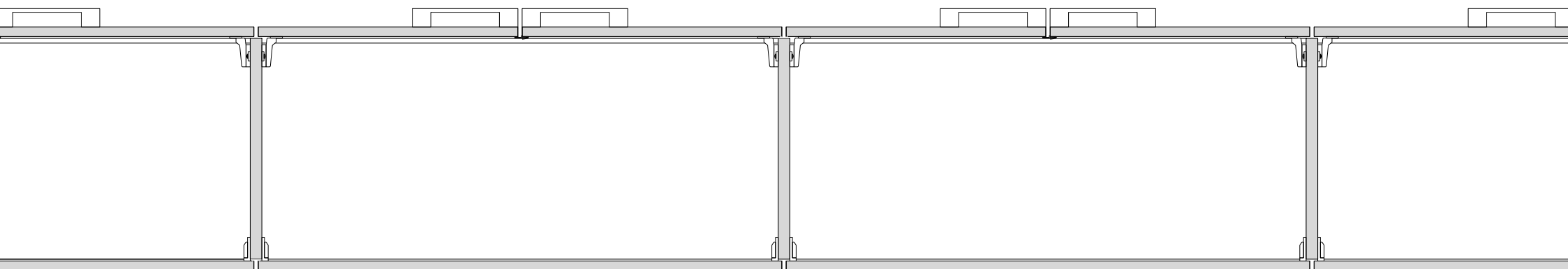

**connessione valida
per tutte le ritmica*

**connessione valida
per tutte le ritmica wood*

Connessioni a tre vie



Connessione a 3 vie
con unica

Connessione a 3 vie
con unica slim

Connessione a 3 vie
con unica d

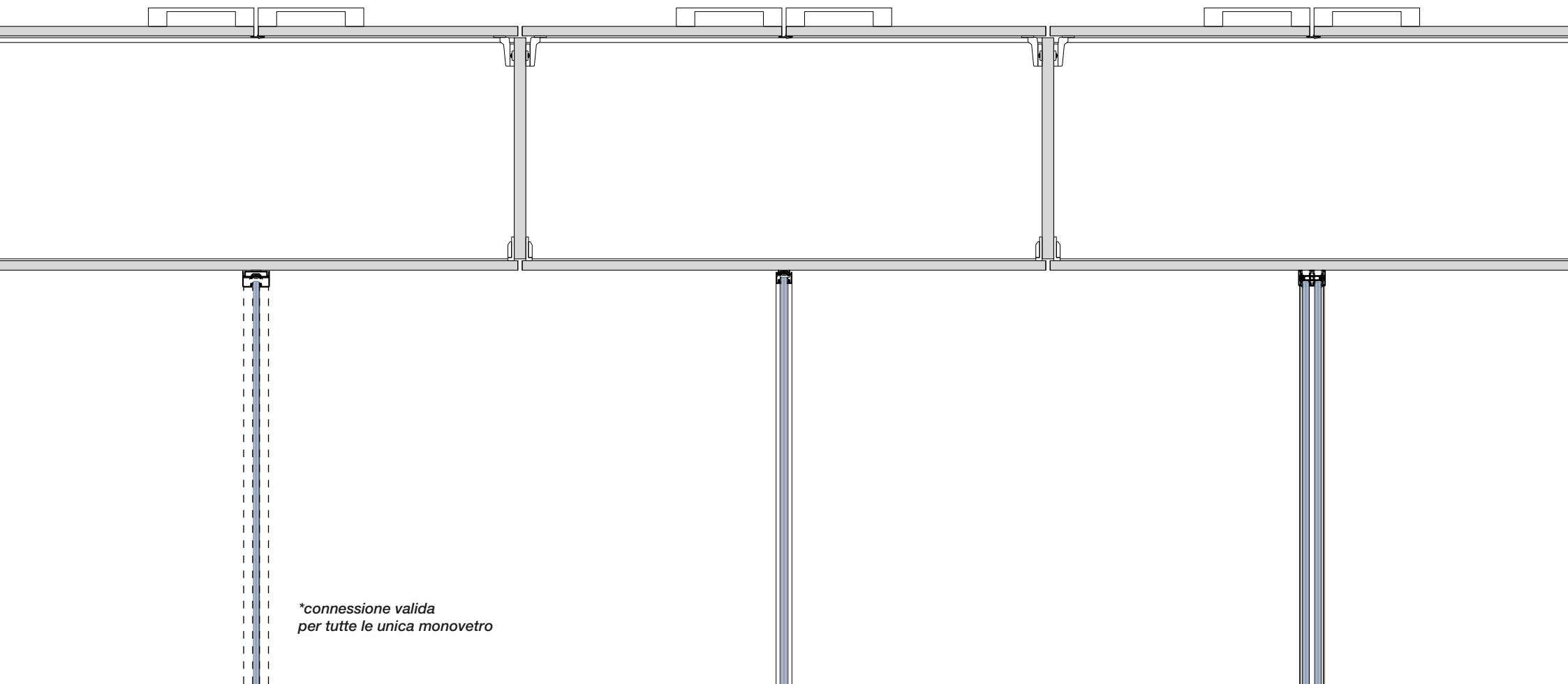

**connessione valida
per tutte le unica monovetro*

Angoli

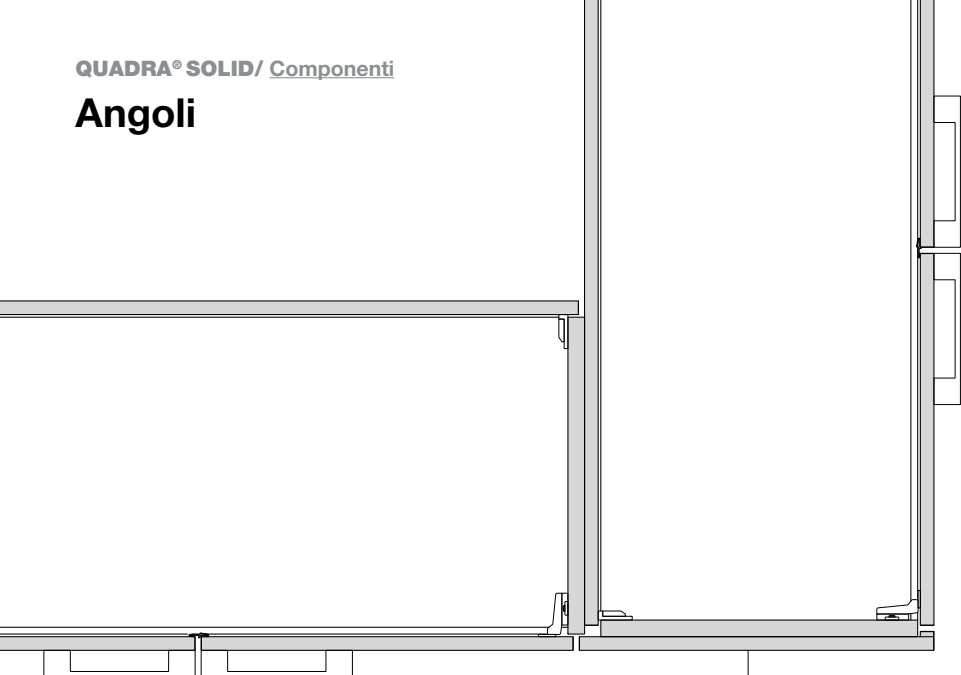

**Angolo a 90°
quadra - quadra**

*fianco terminale
in legno*

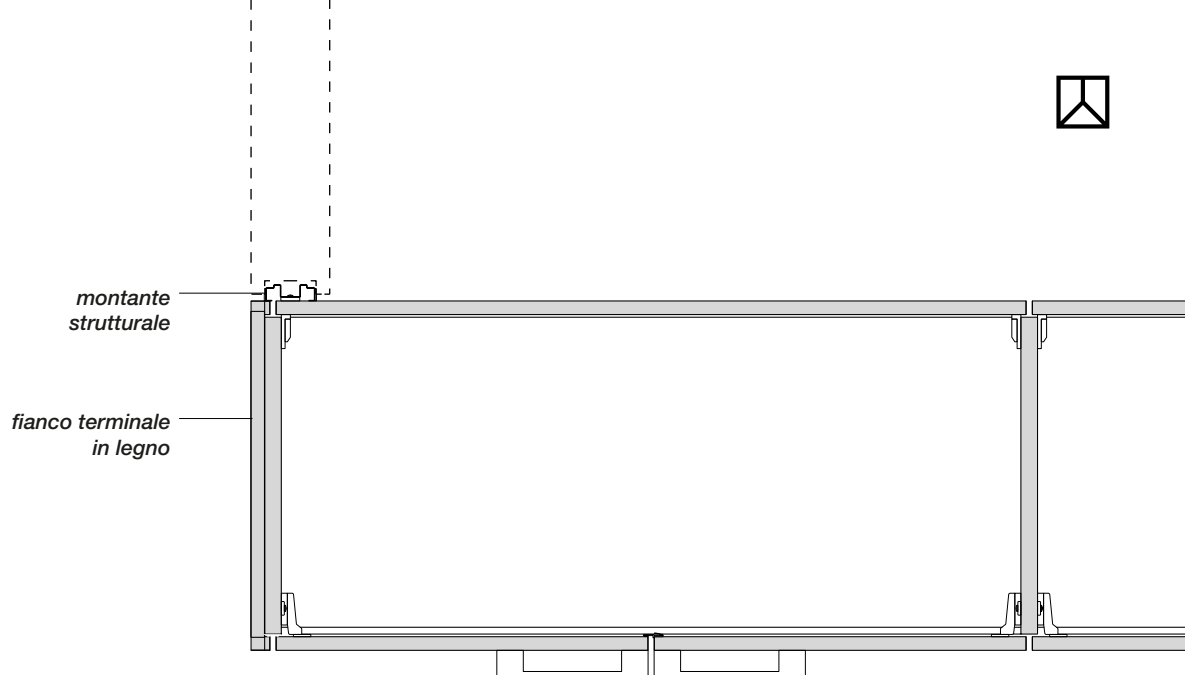

*montante
strutturale*

*fianco terminale
in legno*

**Angolo a 90°
quadra - metrica**

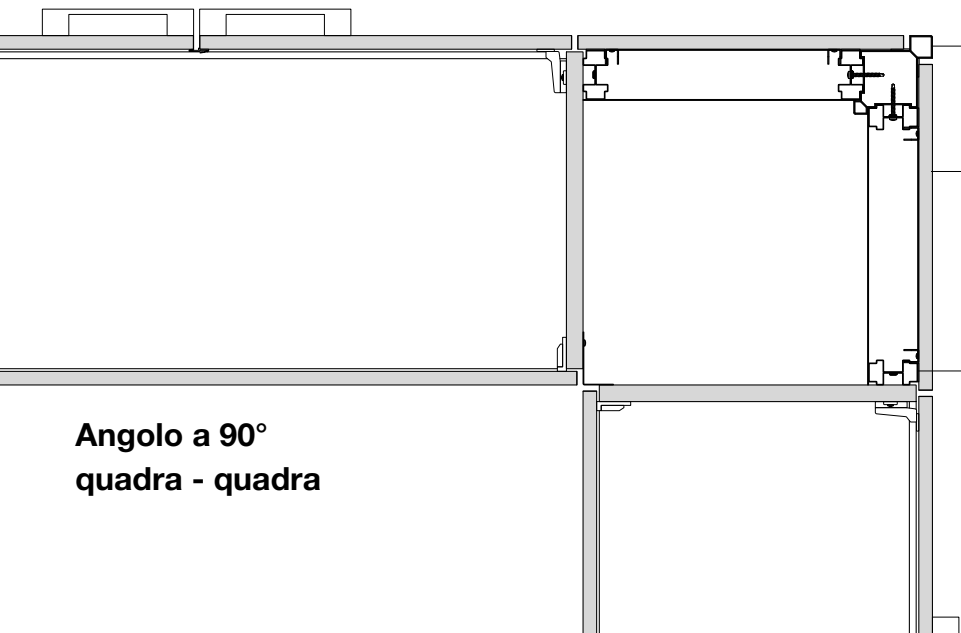

**Angolo a 90°
quadra - quadra**

*angolo in
alluminio*

pannello di chiusura 18 mm

*montante
strutturale*

Coibentazione interna

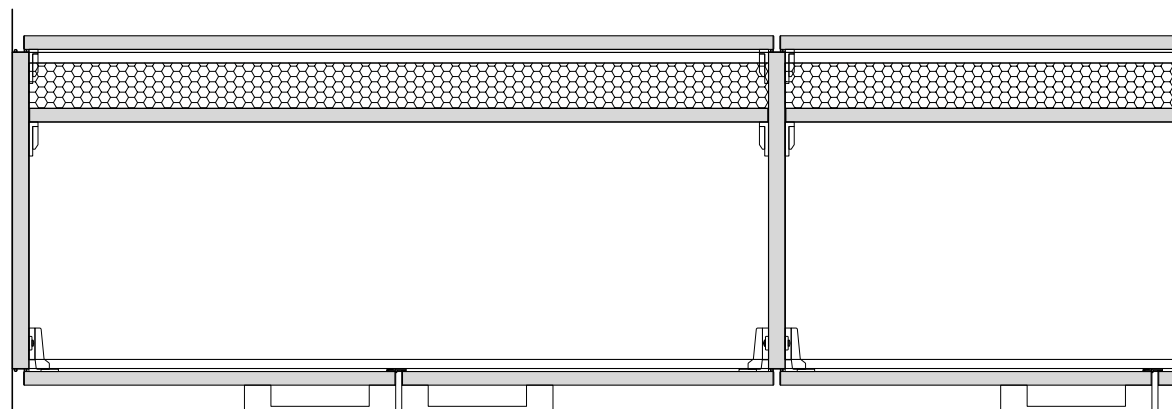
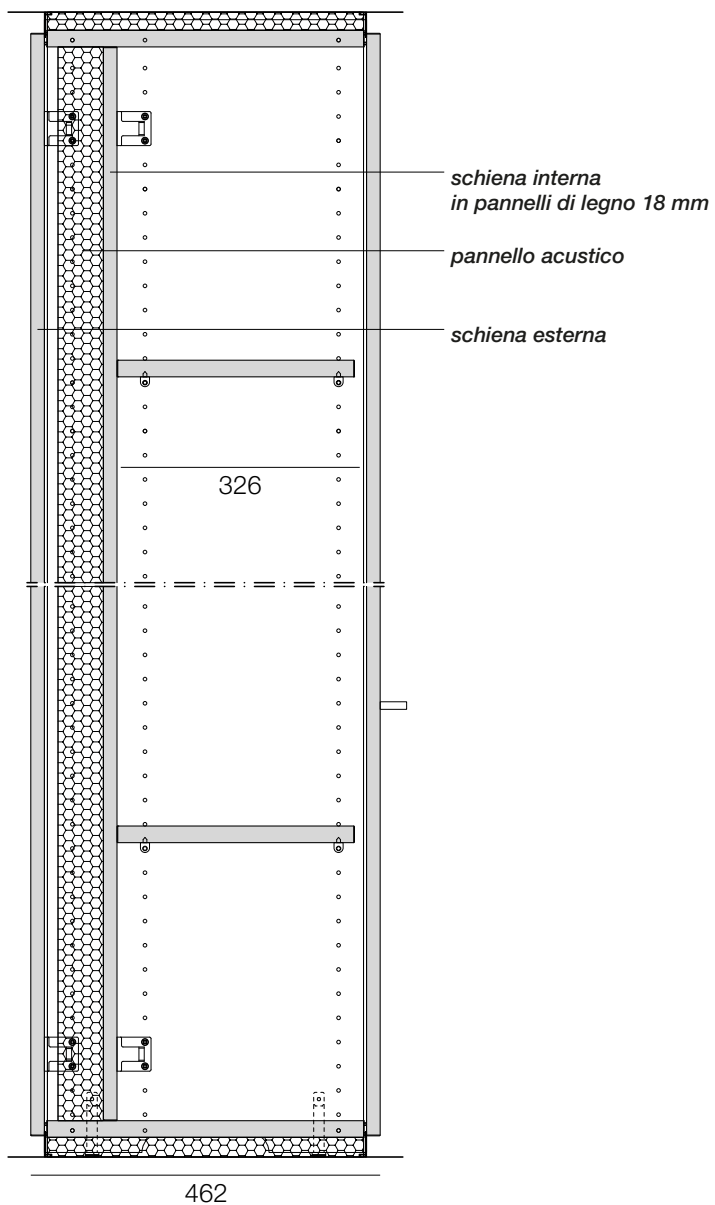

*disponibile solo per profondità 462 mm

QUADRA®

Porte

ANTA CIECA sp. 43 mm

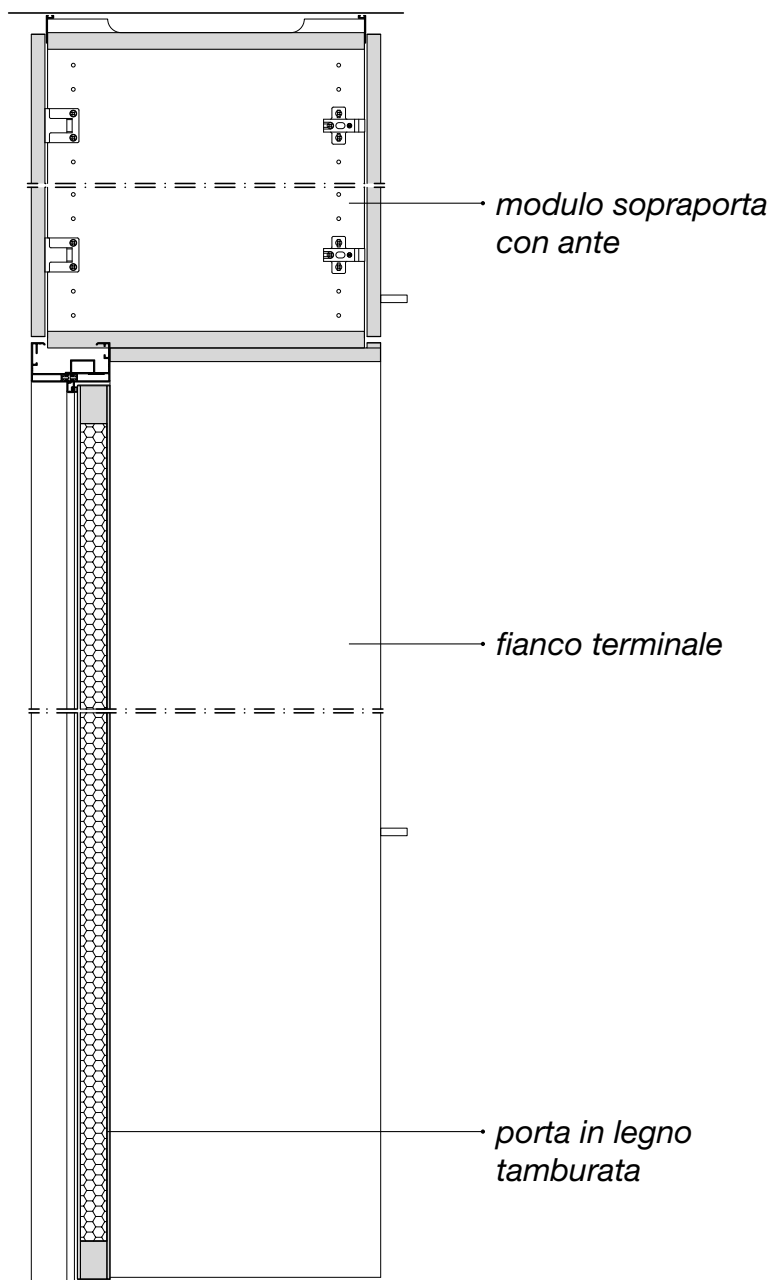

**per tutte le pareti
quadra*

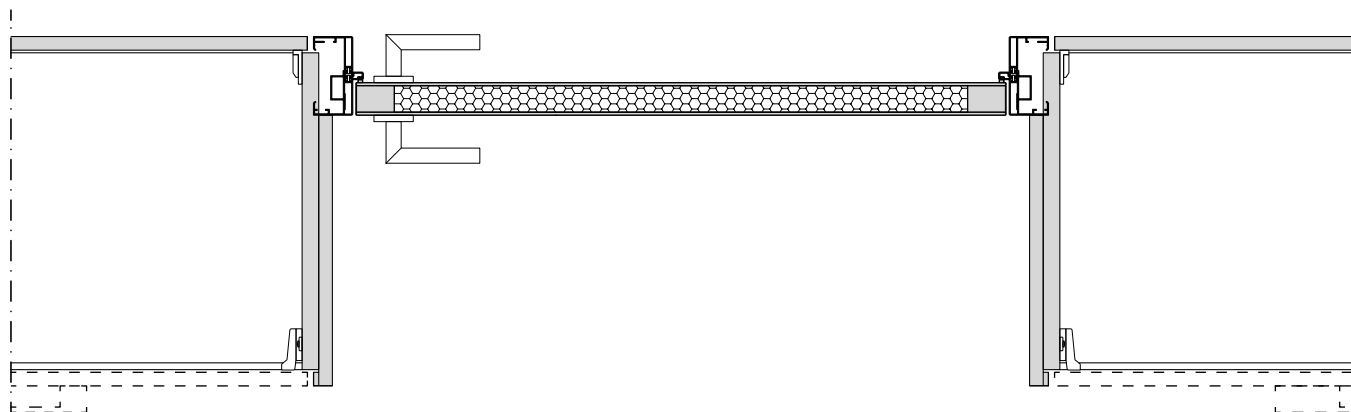

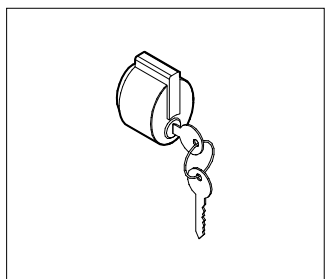

ML01

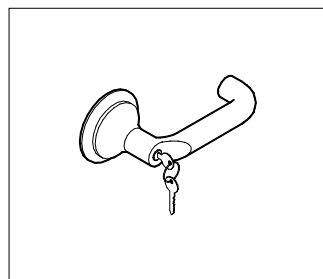

ML04

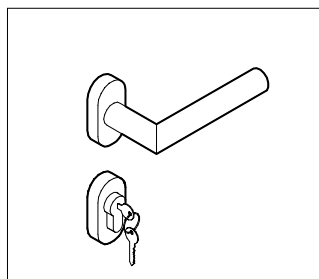

ML05

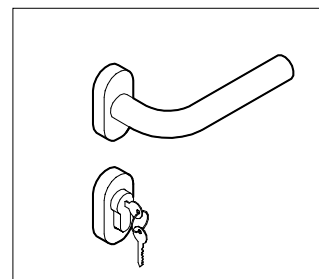

ML06

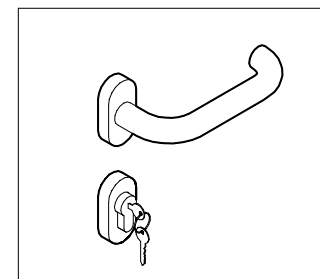

ML07

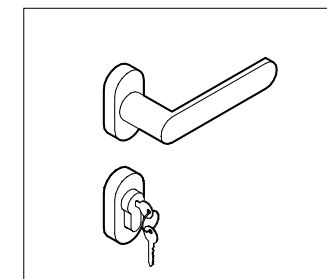

ML08

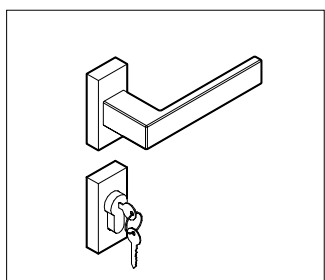

ML09

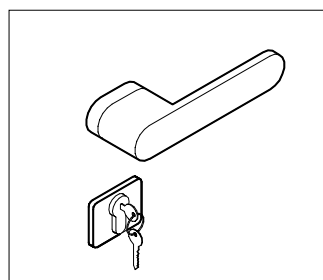

ML10

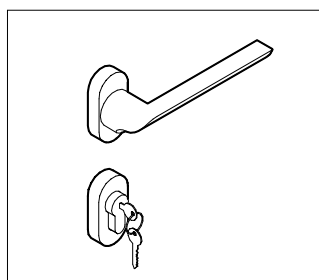

ML11

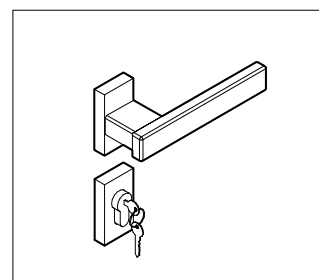

MLQ

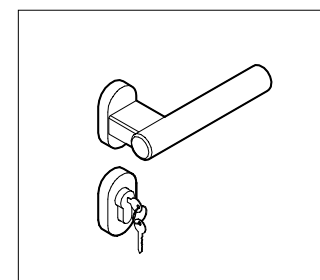

MLT

ANTA VETRO TEMPERATO sp. 10 mm

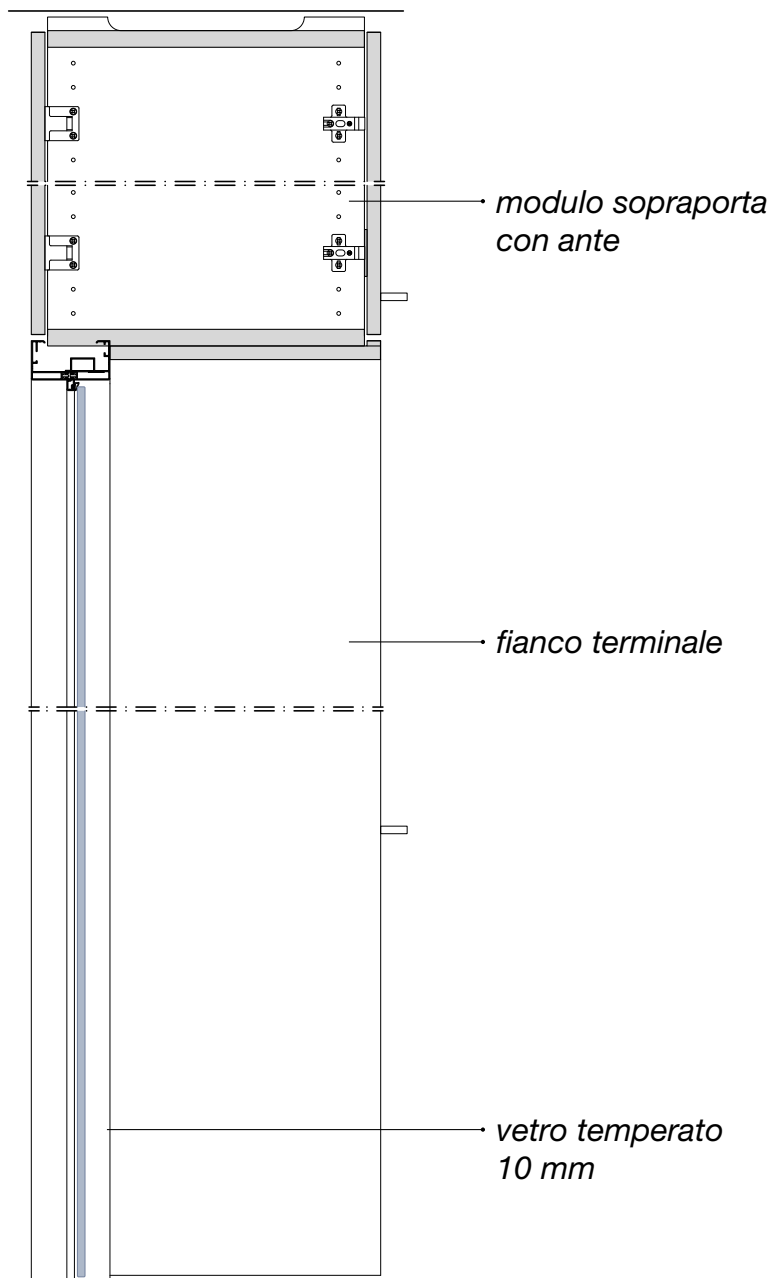

*per tutte le pareti quadra

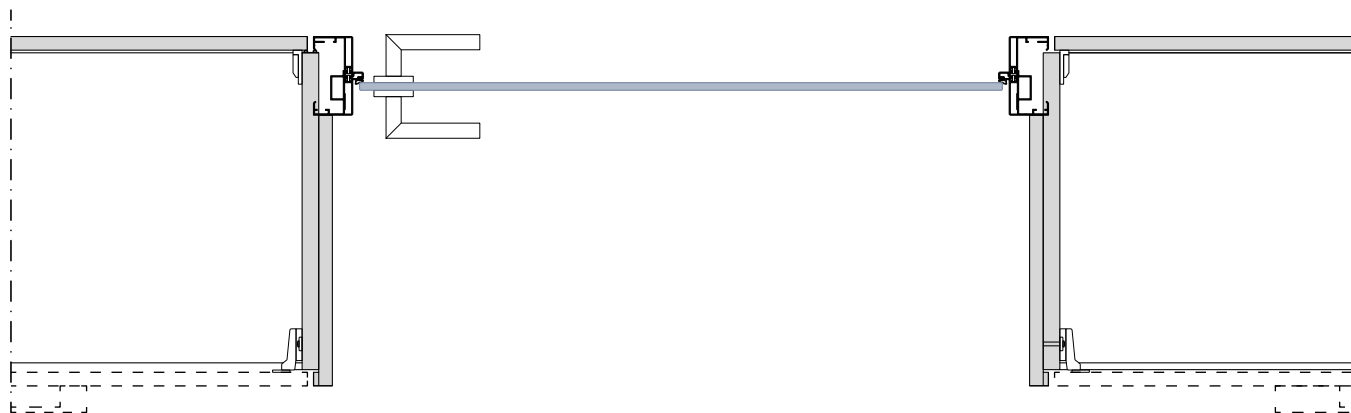

ANTA VETRO TEMPERATO sp. 10 mm

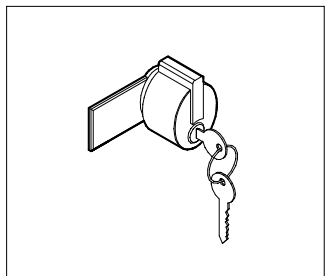

MC01

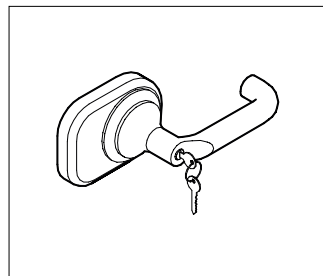

MC04

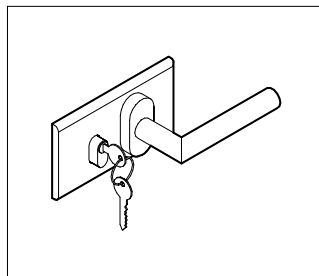

MC05

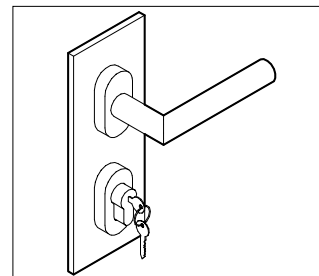

MC05V

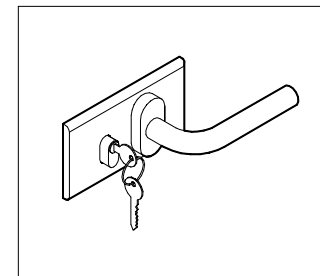

MC06

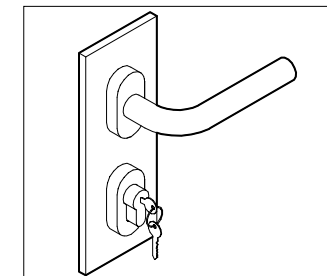

MC06V

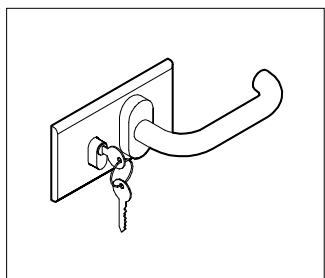

MC07

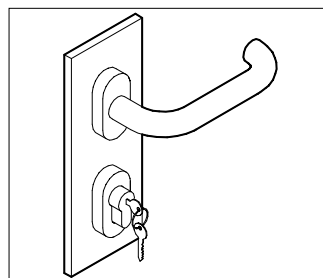

MC07V

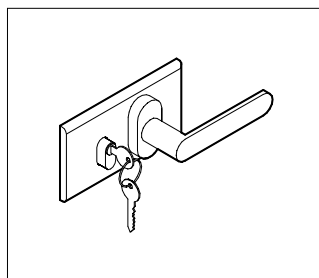

MC08

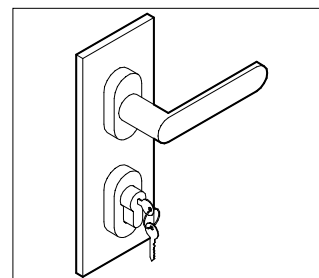

MC08V

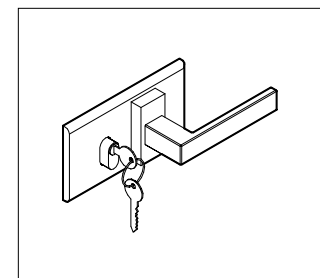

MC09

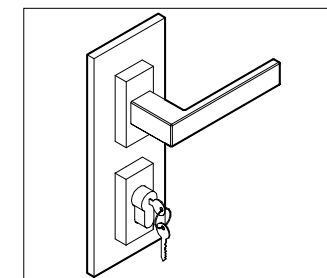

MC09V

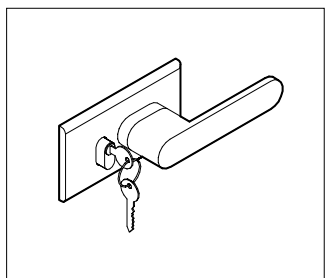

MC10

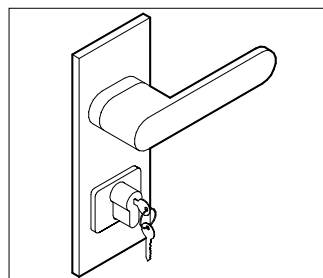

MC10V

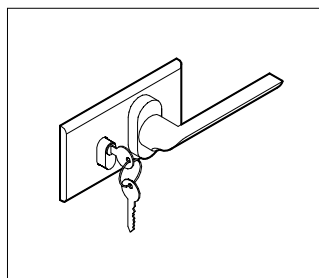

MC11

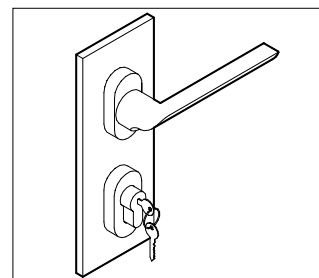

MC11V

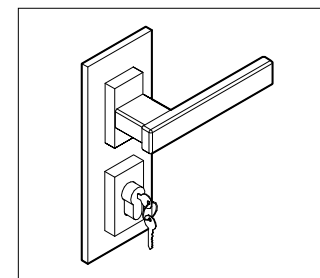

MCQ

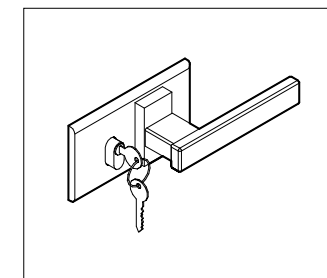

MCQO

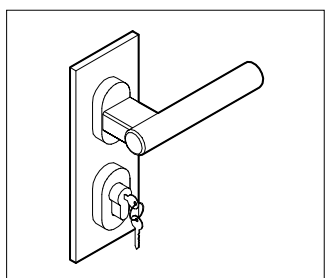

MCT

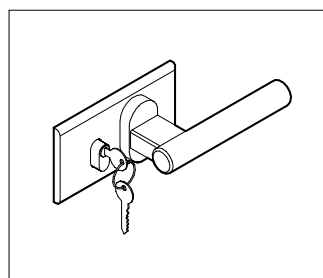

MCTO

QUADRA®

Maniglie

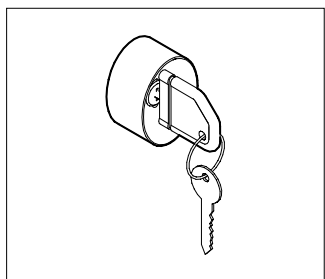

01COMMA1C

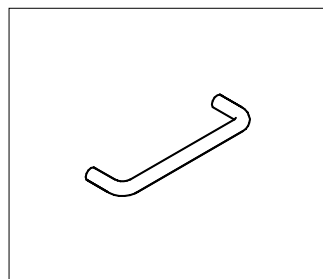

02COMMA2

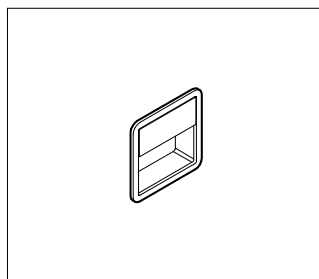

03COMMA3

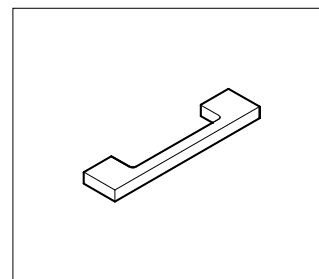

04COMMA4

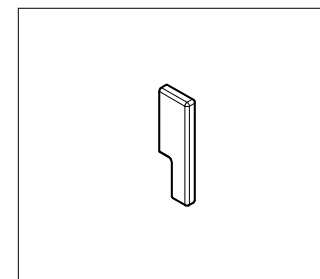

05COMMA5

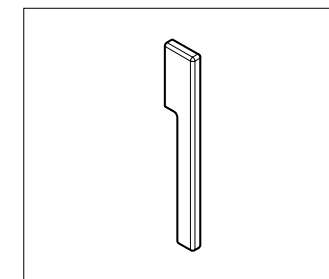

06COMMA6

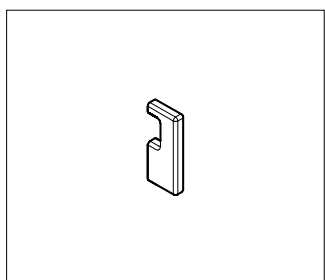

07COMMA7

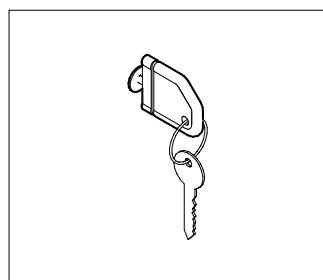

08COMMA9

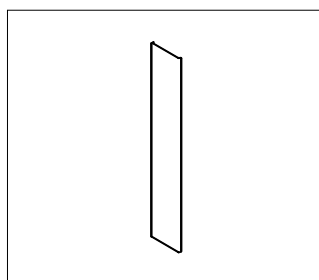

09COMMA10

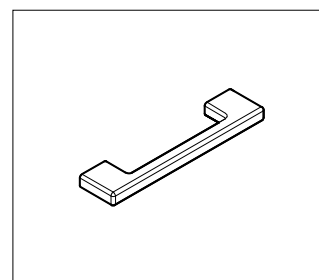

10COMMAQ

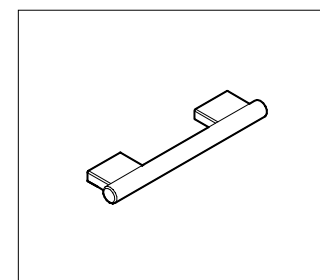

11COMMAT

QUADRA®

Accessori



Ripiani

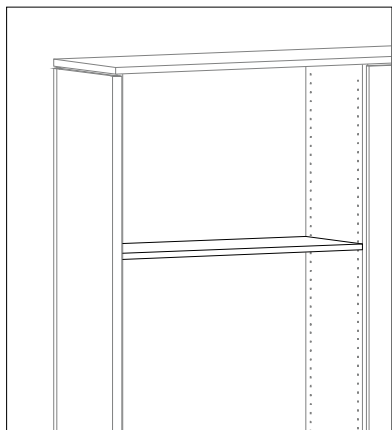

01 ripiano melaminico
L 500/1000 mm

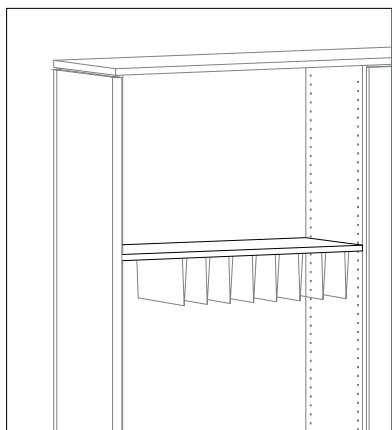

02 ripiano in metallo
L 500/1000 mm

Cassetti

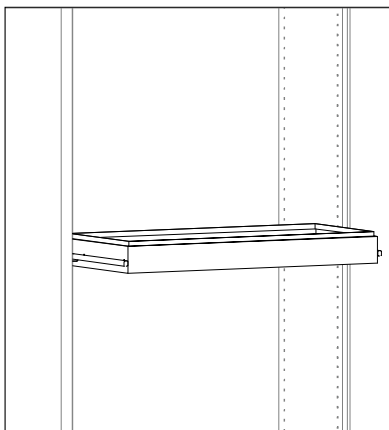

03 telaio estraibile
L 1000 mm

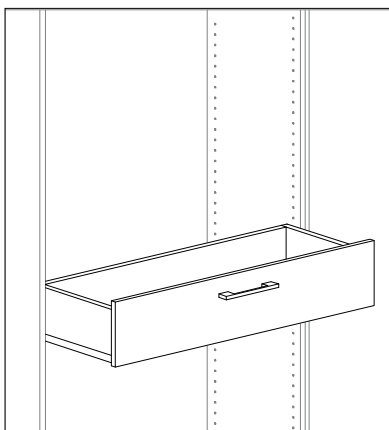

04 cassetto
L 500/1000 mm

Griglie

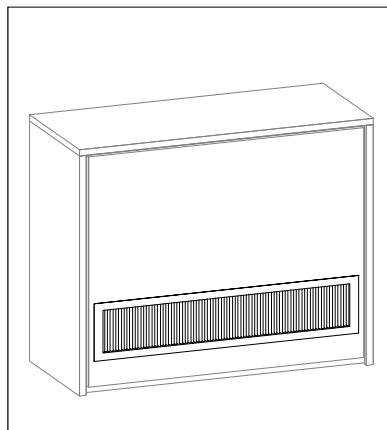

05 griglia frontale

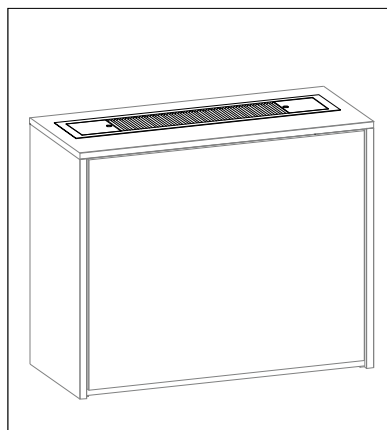

06 griglia superiore

Appendiabiti

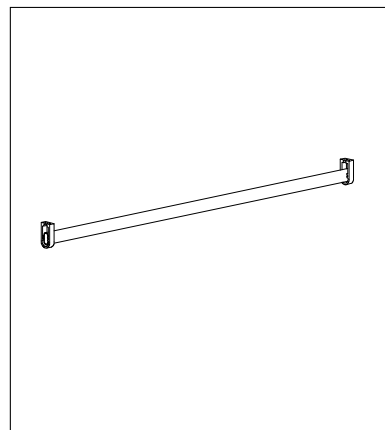

07 asta appendiabiti
L 500/1000 mm

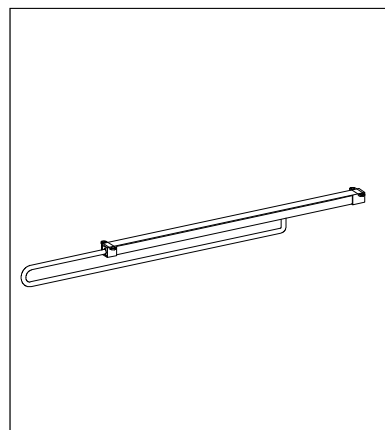

08 appendiabiti estraibile

Fissaggi

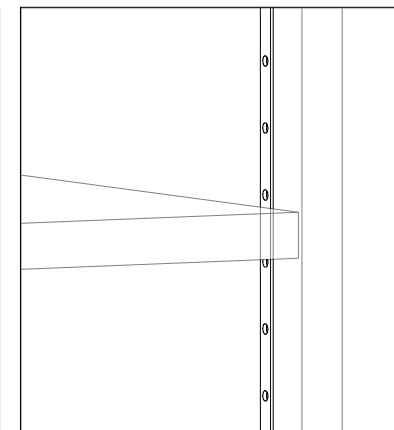

09 profilo a cremagliera

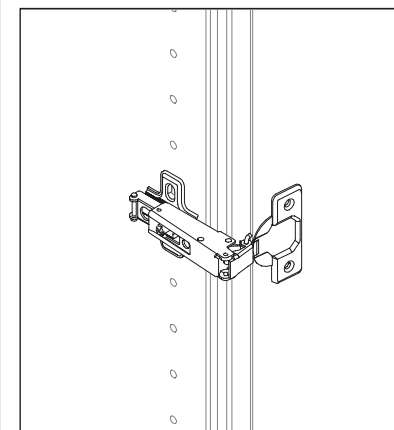

10 cerniera interna
apertura a 180°

QUADRA®

Finiture



Anodizzati

Finiture RAL

Lucidatura

Legni



01 Alluminio naturale



01 Bianco

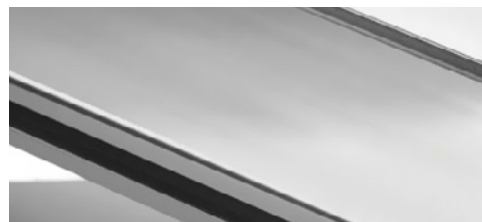

01 Brillantato



01 Rovere chiaro



02 Bronzo

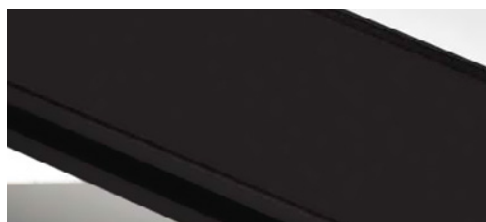

02 Nero

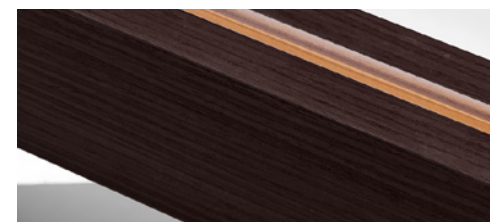

02 Rovere scuro

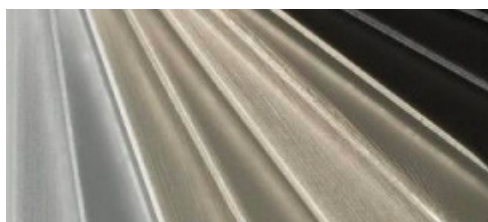

03 Colore a campione



03 Colore a campione

Pannelli ciechi



CAT. 1



055 Nero grafite

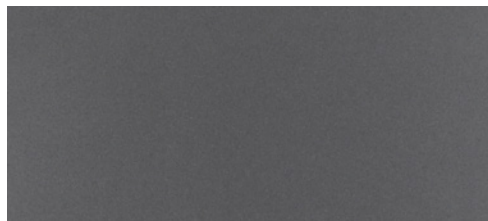

420 Piombo

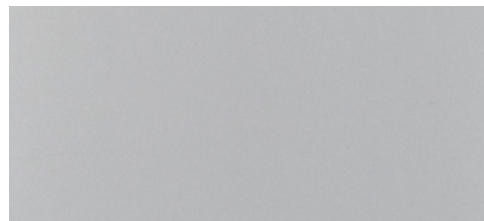

418 Grigio cenere

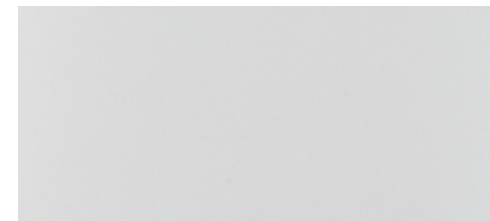

419 Grigio chiaro

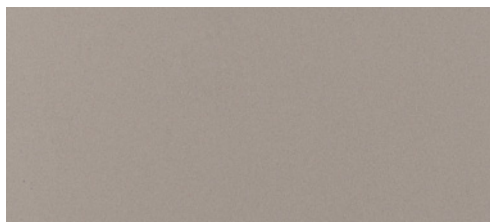

393 Tortora

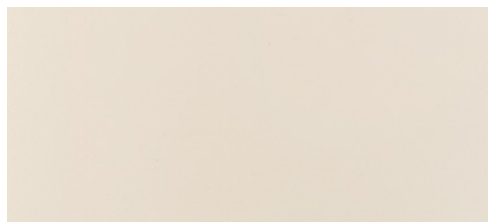

417 Vaniglia

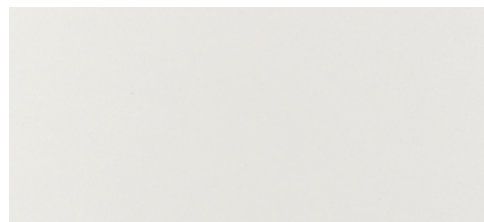

429 Bianco caldo

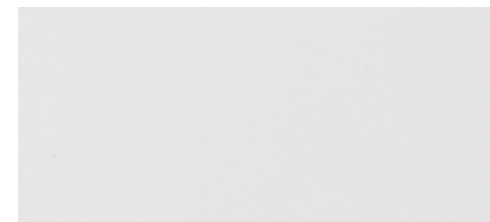

428 Bianco freddo

CAT. 2

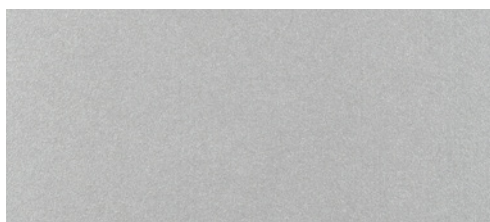

422 Argento

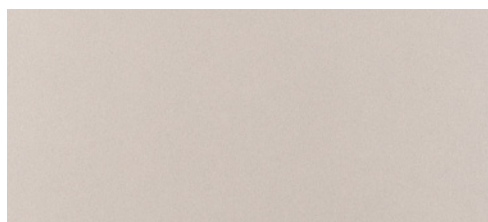

423 Champagne

Legni



CAT. 1

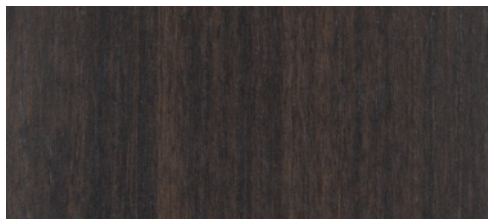

421 Eucalipto

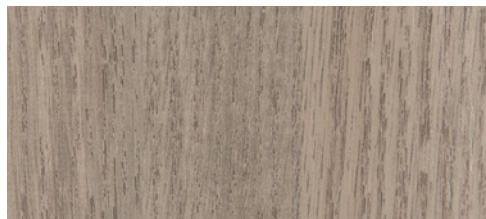

426 Rovere medio



274 Acacia

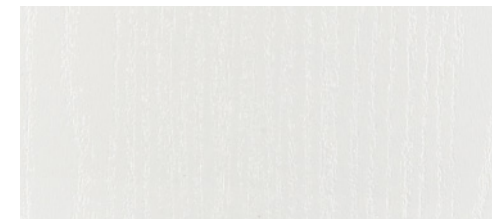

416 Bianco venato

CAT. 2

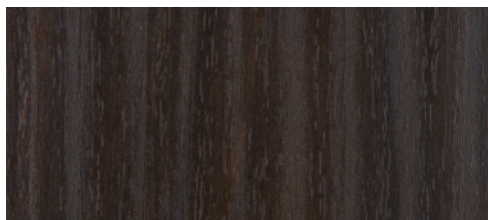

425 Noce scuro

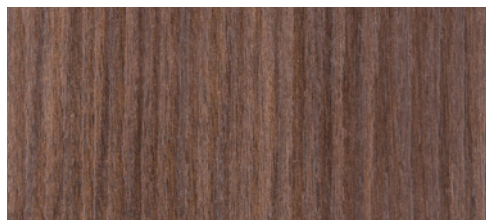

318 Noce medio

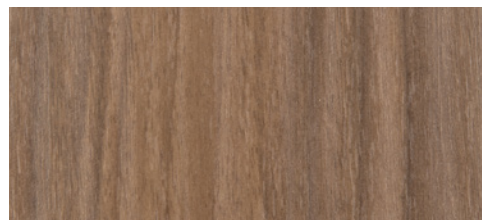

427 Noce chiaro

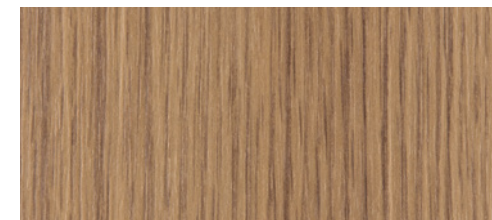

382 Rovere naturale

CAT. 3

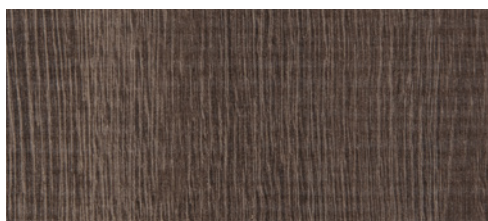

138 Rovere invecchiato - taglio seta

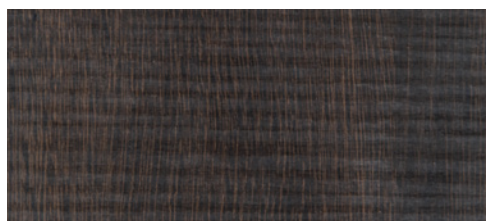

197 Eucalipto - taglio seta

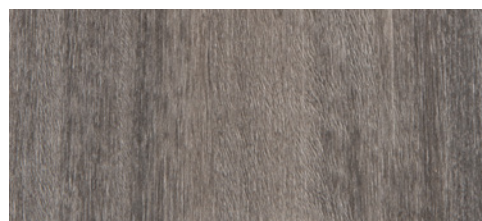

408 Rovere grigio

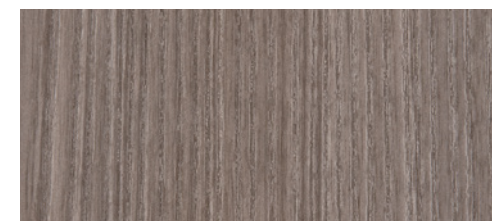

400 Rovere Danubio

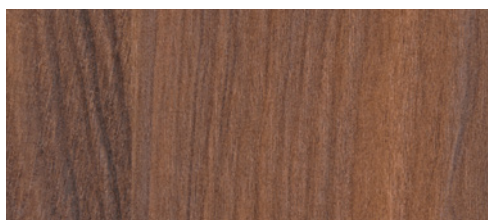

414 Noce rosso

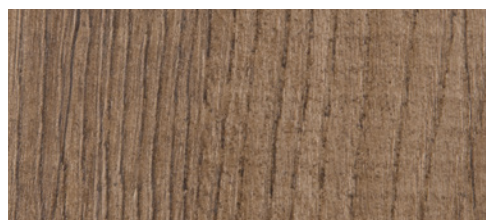

412 Rovere vintage

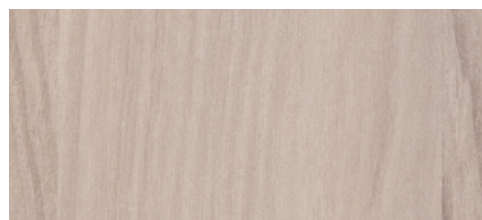

413 Rovere champagne

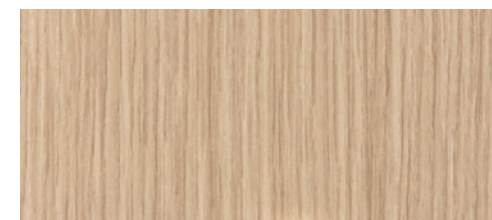

410 Rovere chiaro

Materici



CAT. 2

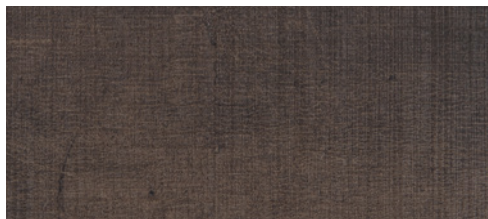

304 Tessuto scuro

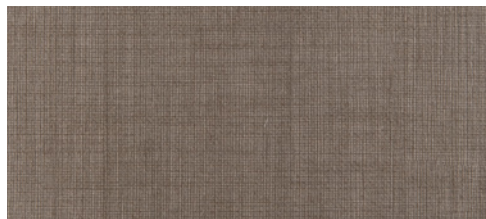

123 Tessuto medio

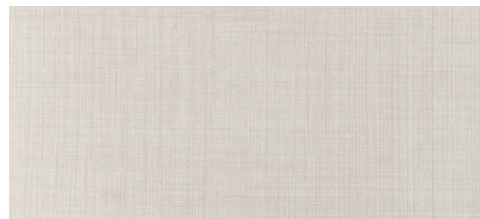

305 Tessuto chiaro



424 Ossido

CAT. 3

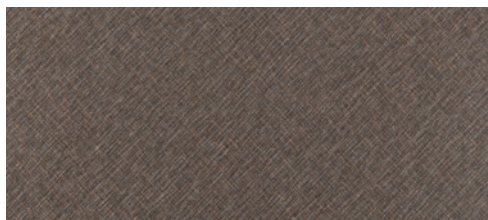

385 Lino bronzo

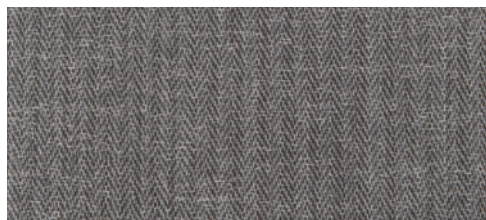

409 Corteccia

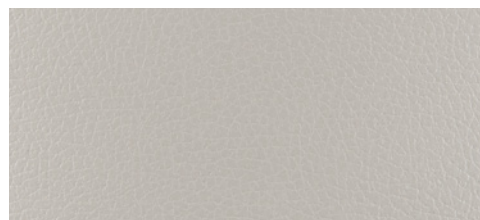

406 Primo fiore grigio

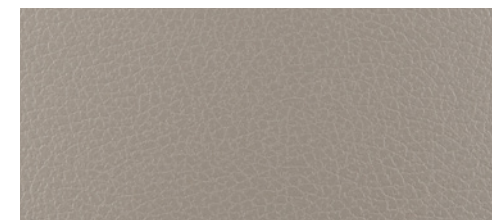

405 Primo fiore tortora

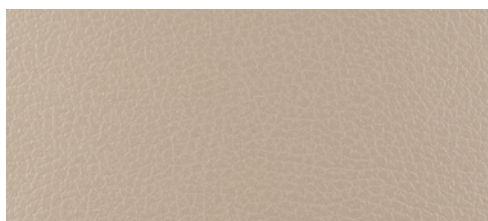

404 Primo fiore beige

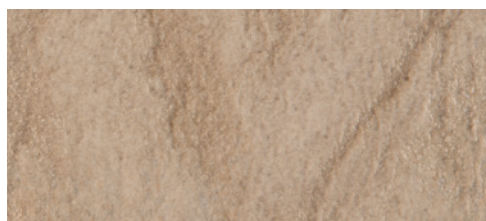

415 Deserto

Vetri



01 Trasparente



03 Satinato

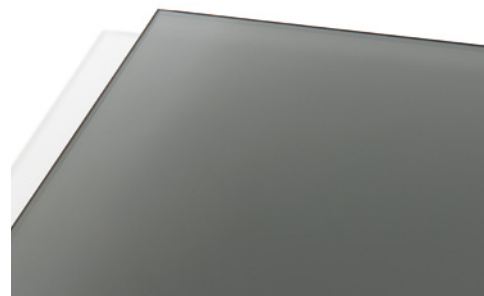

05 Fumé



02 Extrachiaro

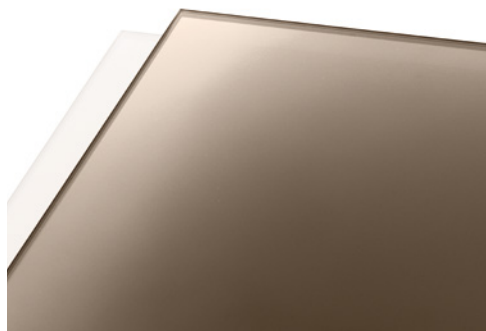

04 Bronzo



06 Verniciato a campione



Etoile s.r.l. - Società Unipersonale

Via D. Albertario, 50 61032 Zona Ind.le Bellocchi - Fano (PU) Italy
P. +39.0721.85.59.34 - F. +39.0721.85.92.14
info@etoilesrl.it - www.etoilesrl.it