

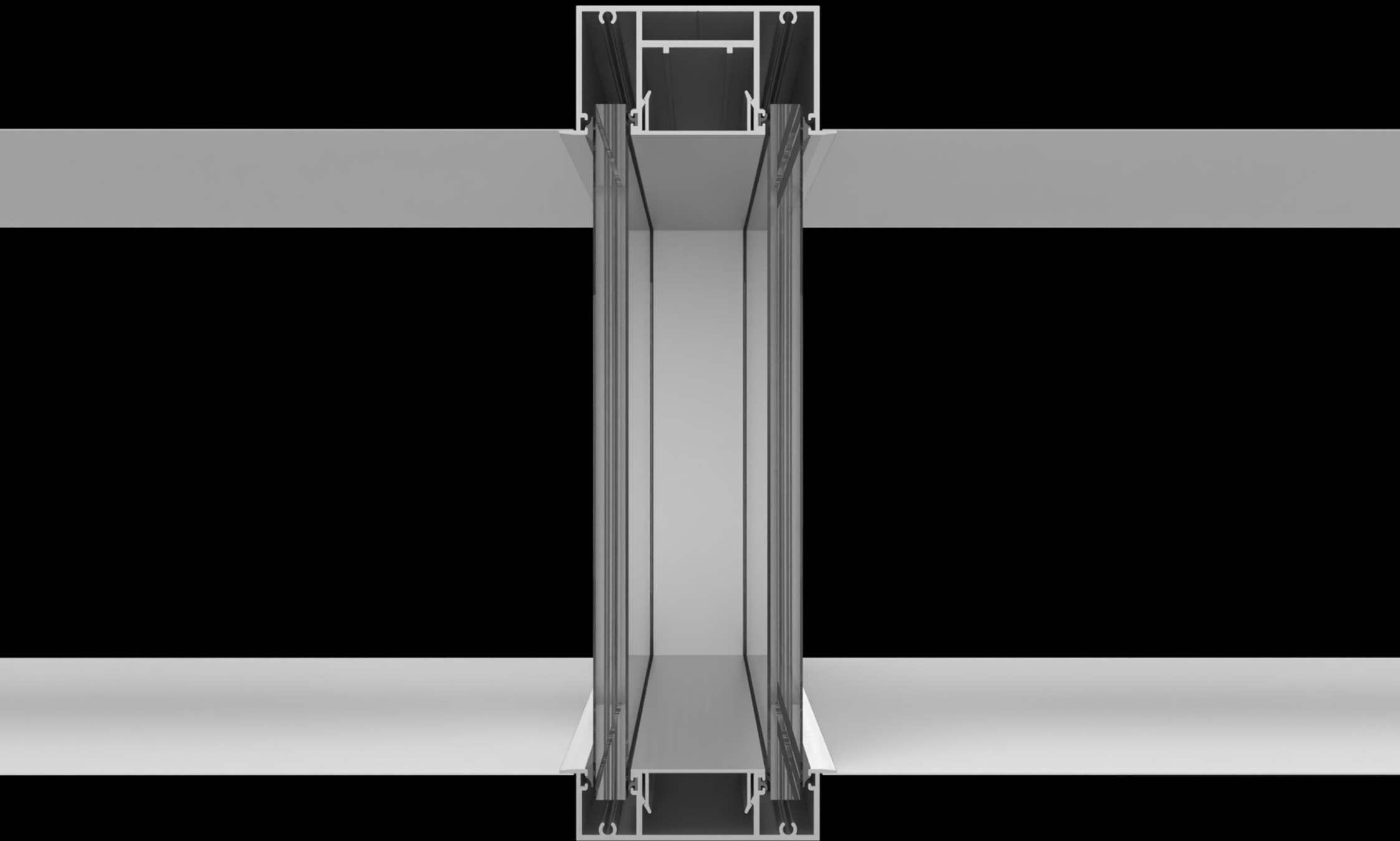

☐ ETOILE

METRICA® F2





- 01.** Spessore 97 mm
- 02.** Profili incassati a pavimento, a soffitto, angoli e partenze in estruso di alluminio 6060 UNI 9006/1
- 03.** Doppio vetro intelaiato - spessore 55.1/55.2/66.1/66.2 o temperato 10/12 mm
- 04.** Profili d'angolo fissi e variabili - connessioni 2/3 vie
- 05.** Giunzioni verticali tra elementi vetrati in alluminio, policarbonato e biadesivo trasparente
- 06.** Modulo tecnico
- 07.** 5 versioni di porte battenti - cieche, in vetro temperato e intelaiate
- 08.** 1 versione di porta scorrevole interna - intelaiata



Partenze

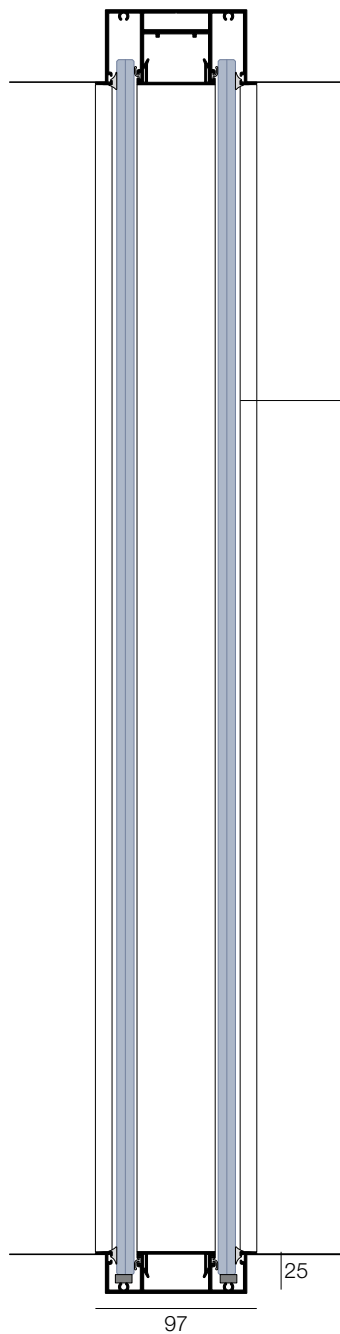

*doppio vetro 55.1 stratificato
doppio vetro 55.2 stratificato
doppio vetro 66.1 stratificato
doppio vetro 66.2 stratificato*

*doppio vetro 10 mm temperato
doppio vetro 12 mm temperato*

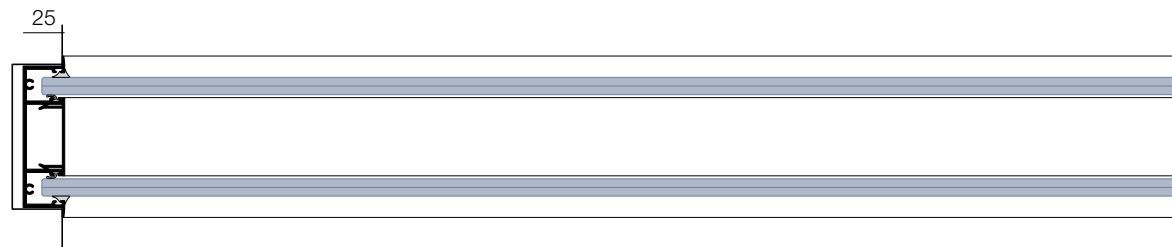

Partenza incassata a parete

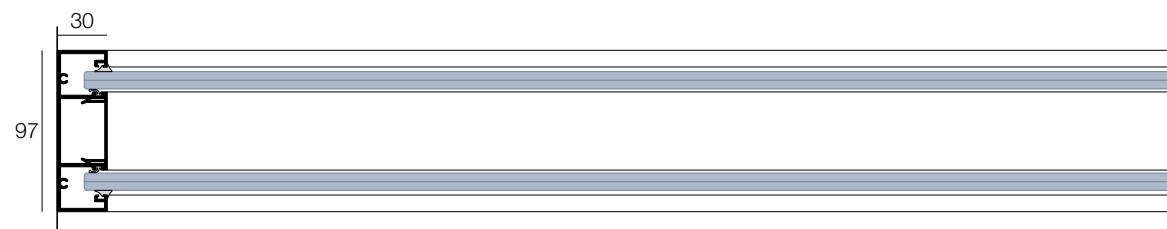

Partenza fissa da parete

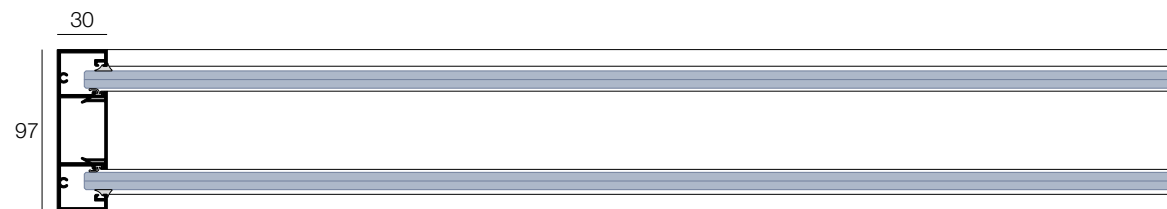

Profilo terminale



Partenza da contenitore

Partenza da contenitore incassata

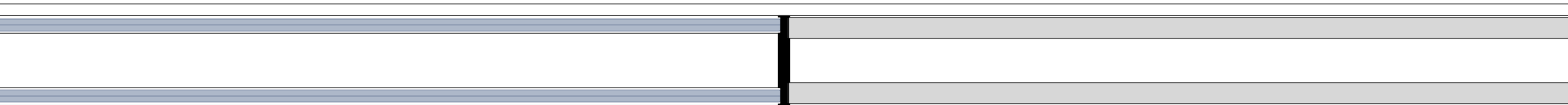

**Connessione in alluminio
metrica f2 - metrica f solid**

variabile

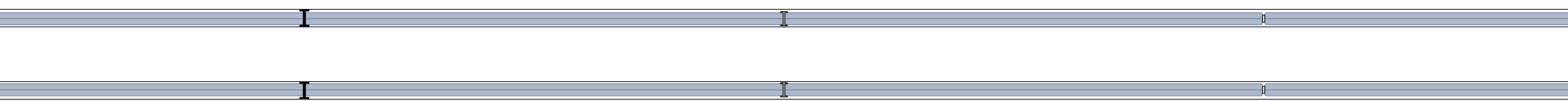

**Connessione
in alluminio**

**Connessione
in policarbonato**

**Connessione
con biadesivo tecnico**

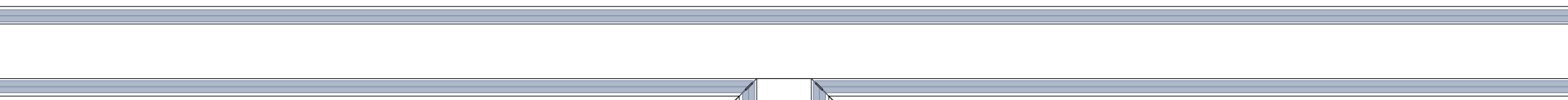

**Connessione a tre vie
con biadesivo tecnico**

Angoli

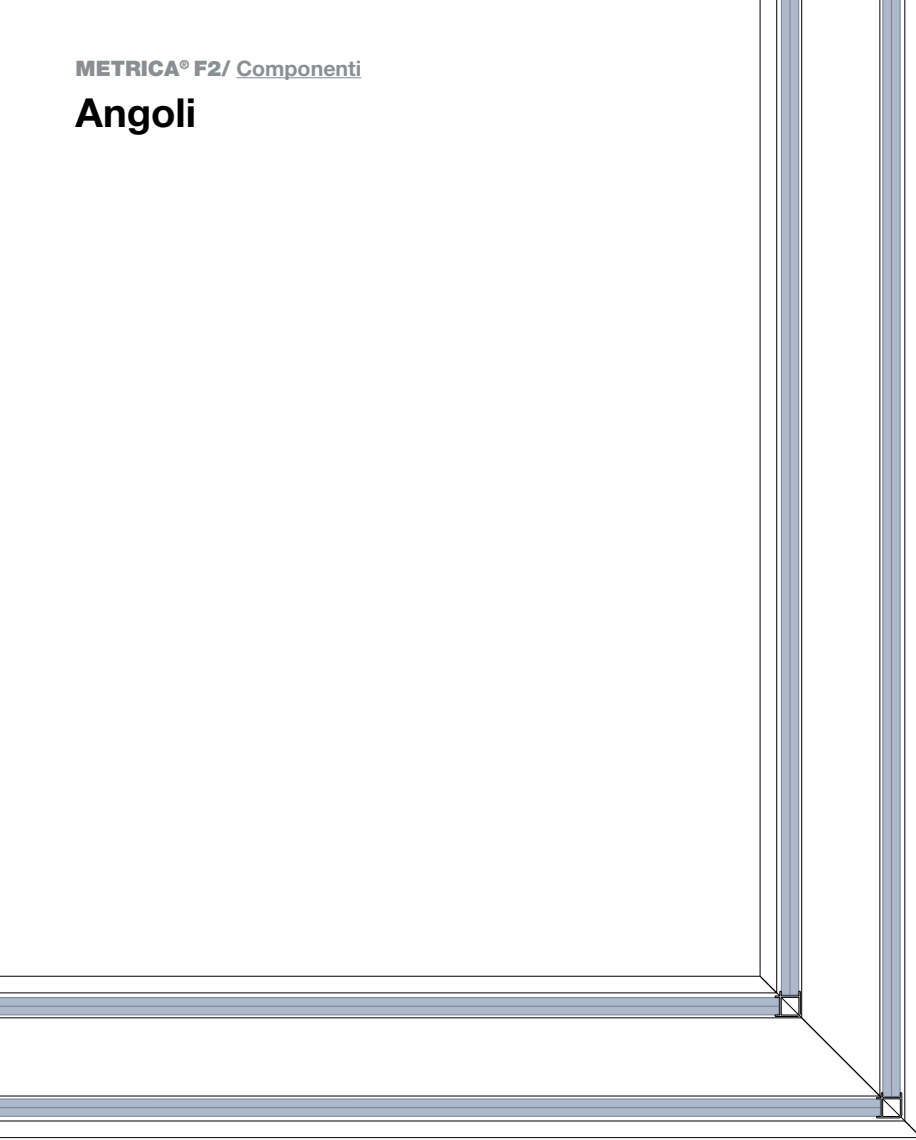

**Angolo a 90°
in policarbonato**

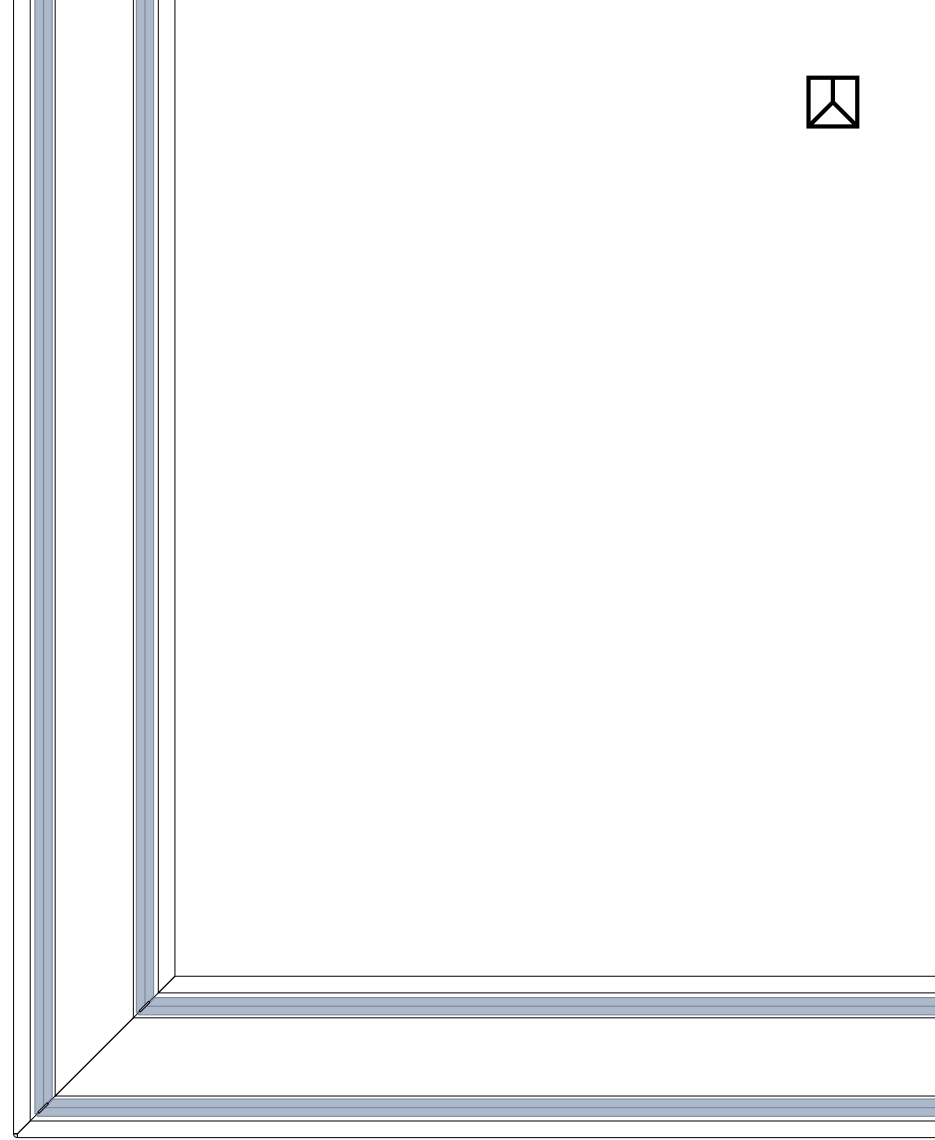

**Angolo a 90°
con biadesivo**

Modulo tecnico della porta a battente



Modulo tecnico

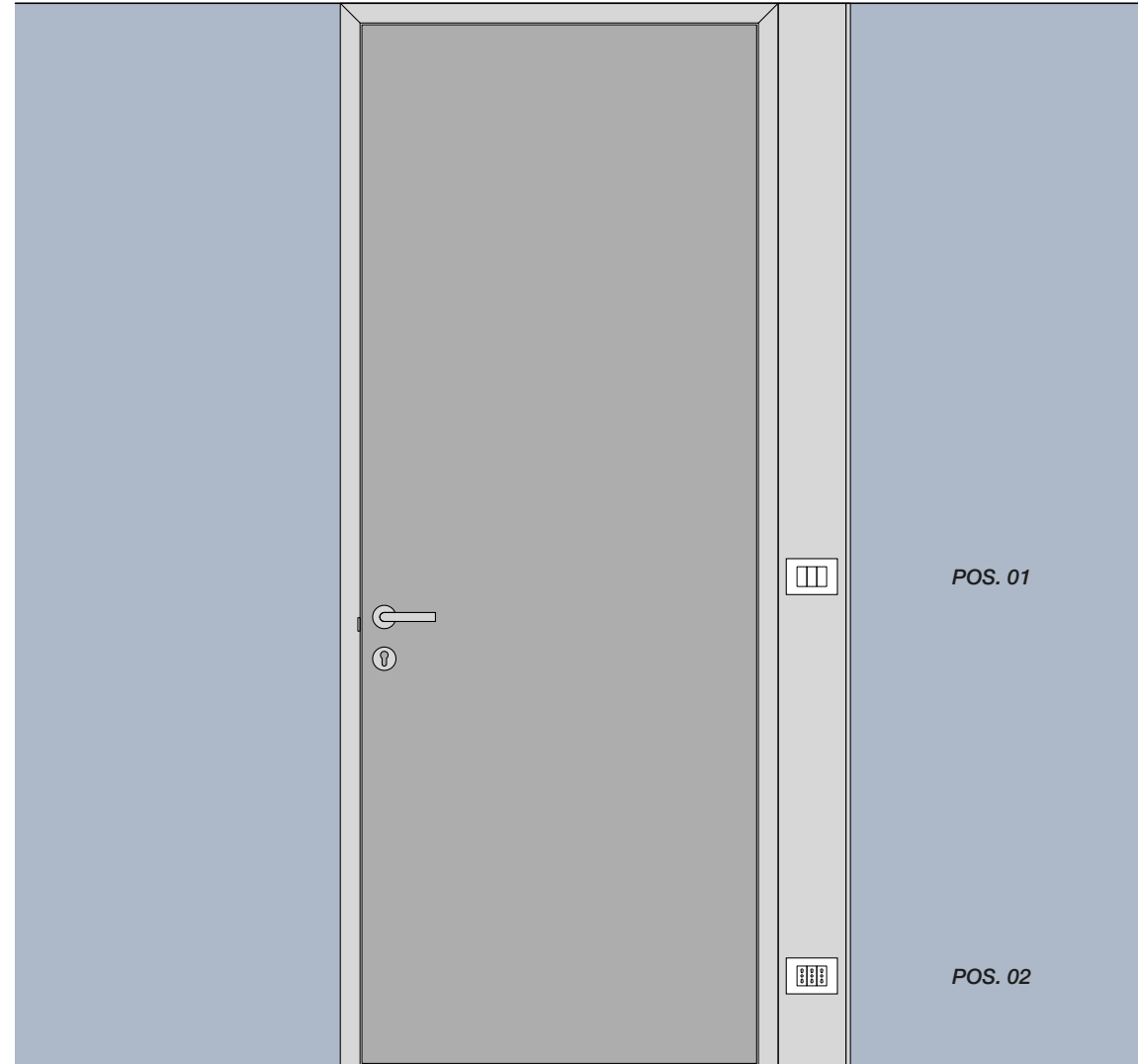
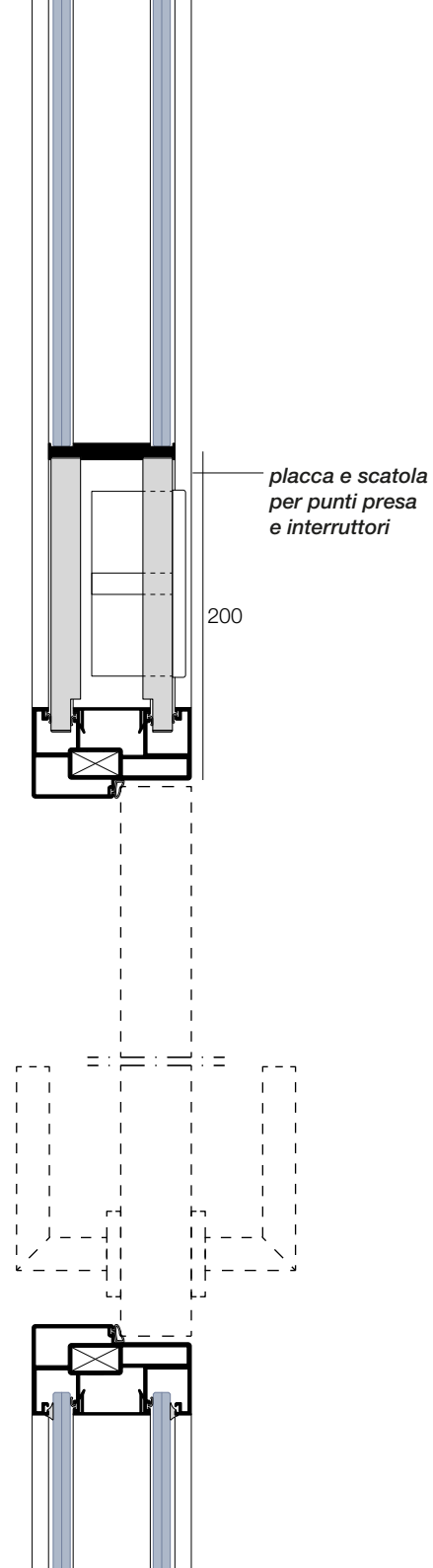

**posizioni possibili di interruttori e prese su modulo tecnico*

METRICA[®]
SENZA STRUTTURA

Porte e maniglie

TELAI PORTE BATTENTI

Metrica D



Telaio porta **Metrica D** su **Metrica D1**

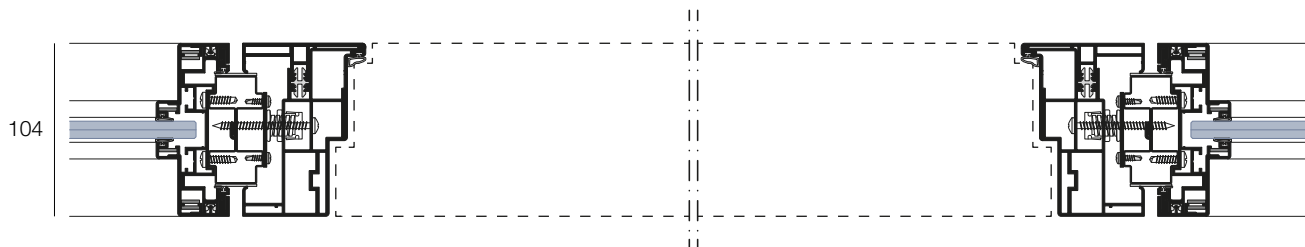

Telaio porta **Metrica D** su **Metrica D2**

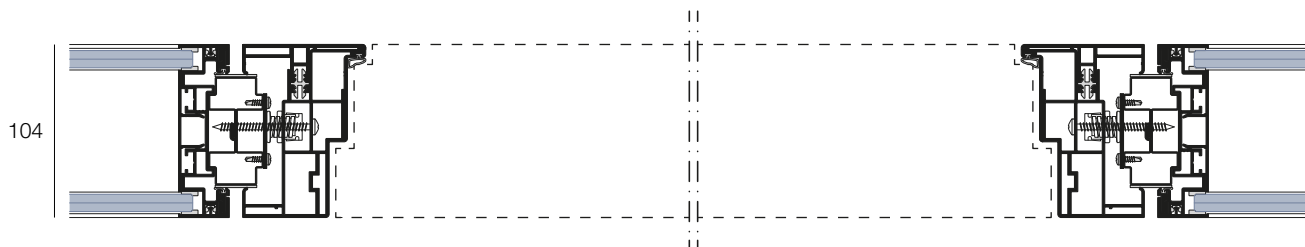

Telaio porta **Metrica D** su **Metrica Solid**

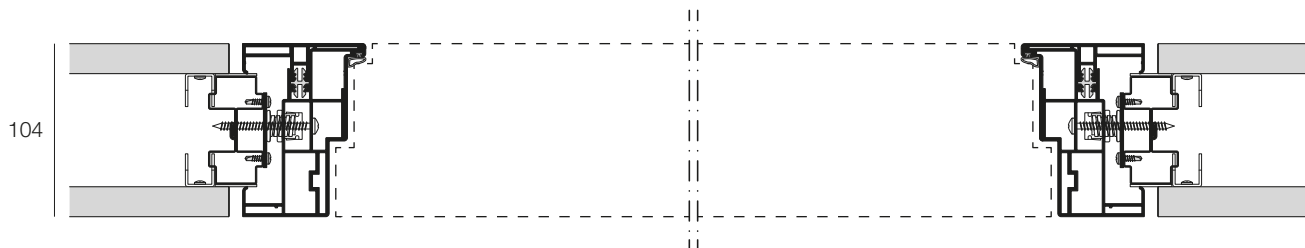

ANTA INTELAIATA CIECA_CON DOPPIA BATTUTA sp. 104 mm

Porta complanare

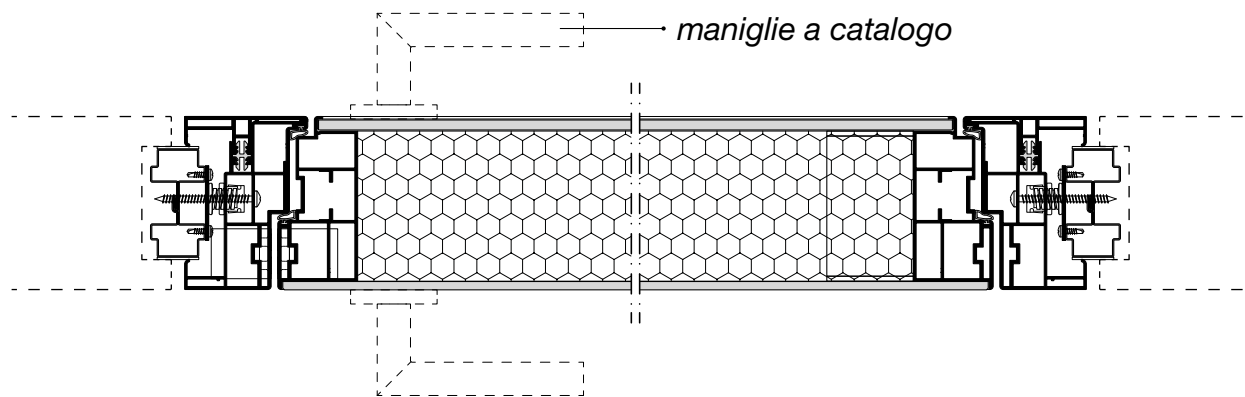
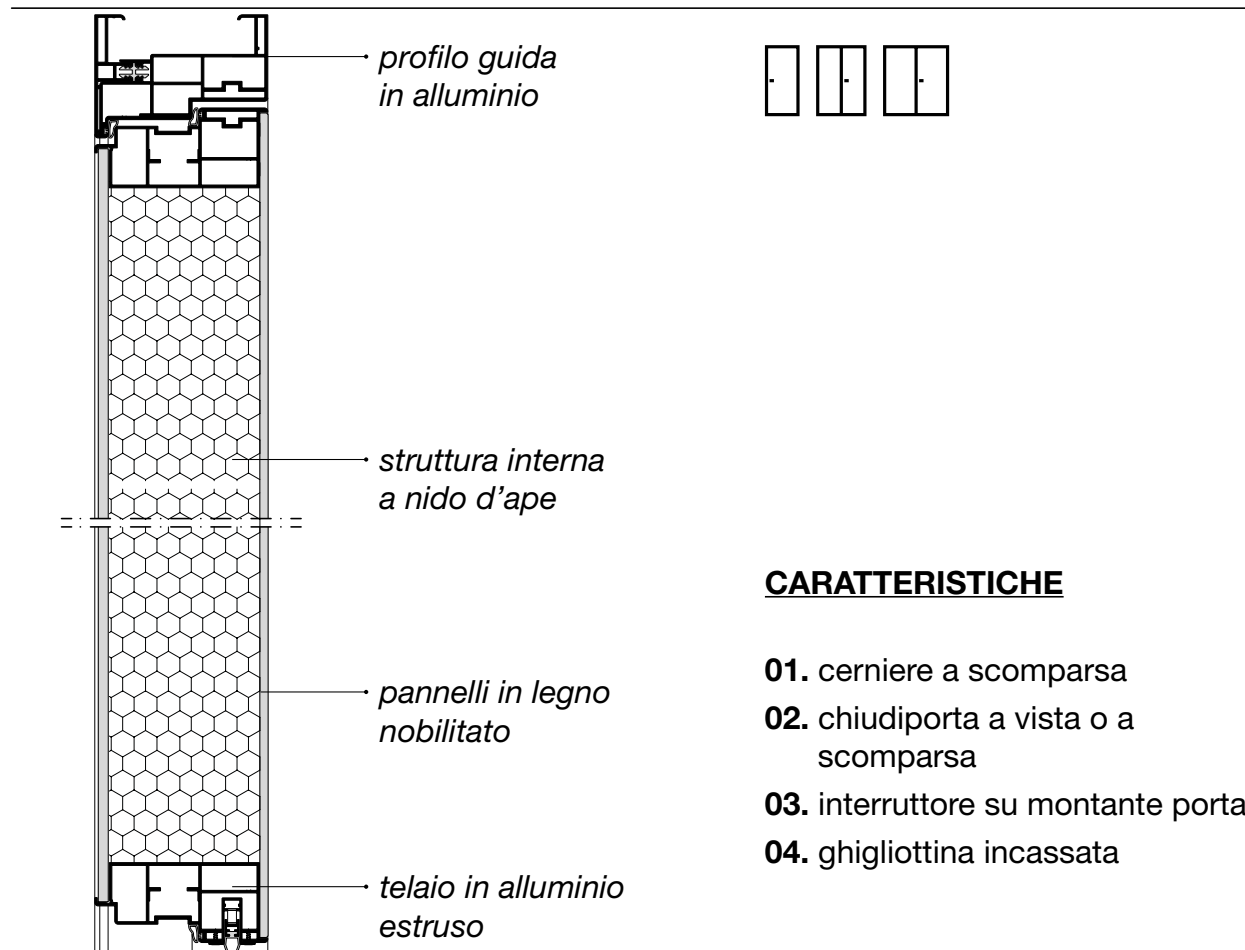

ANTA INTELAIATA CIECA_ CON DOPPIA BATTUTA sp. 104 mm

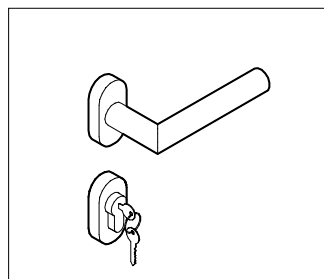

ML5

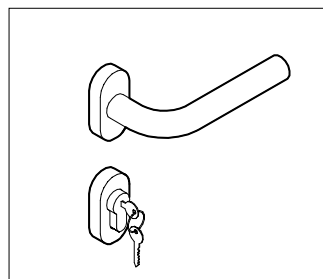

ML6

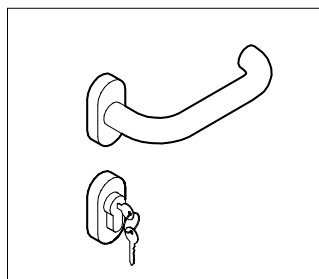

ML7

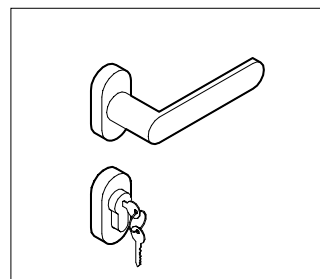

ML8

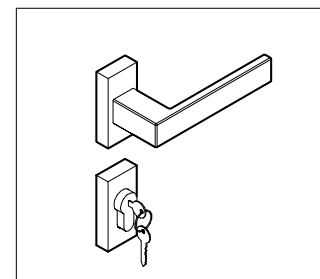

ML9

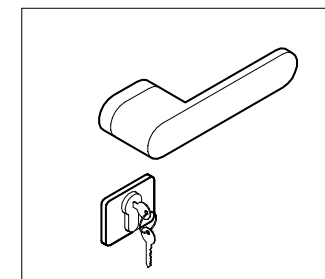

ML10

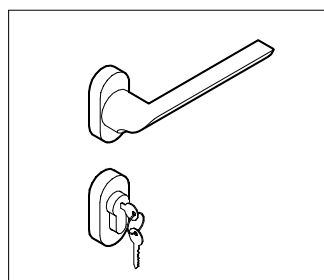

ML11

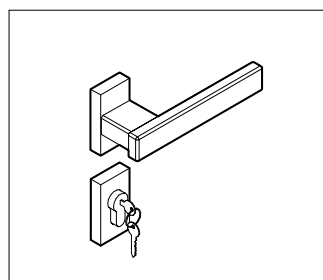

MLQ

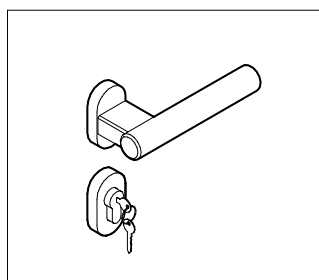

MLT

ANTA INTELAIATA VETRO DOPPIO SERIGRAFATO_CON DOPPIA BATTUTA sp. 104 mm



Porta complanare

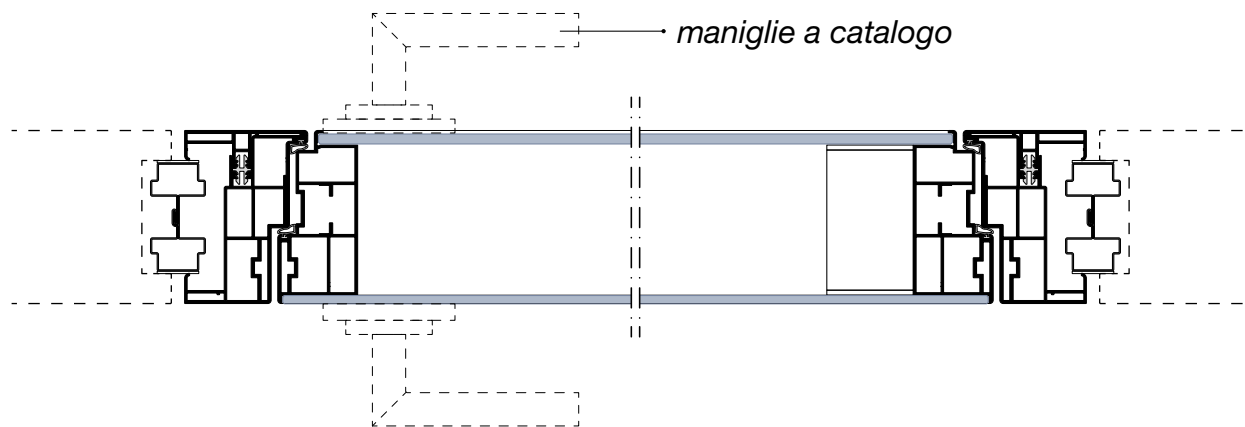
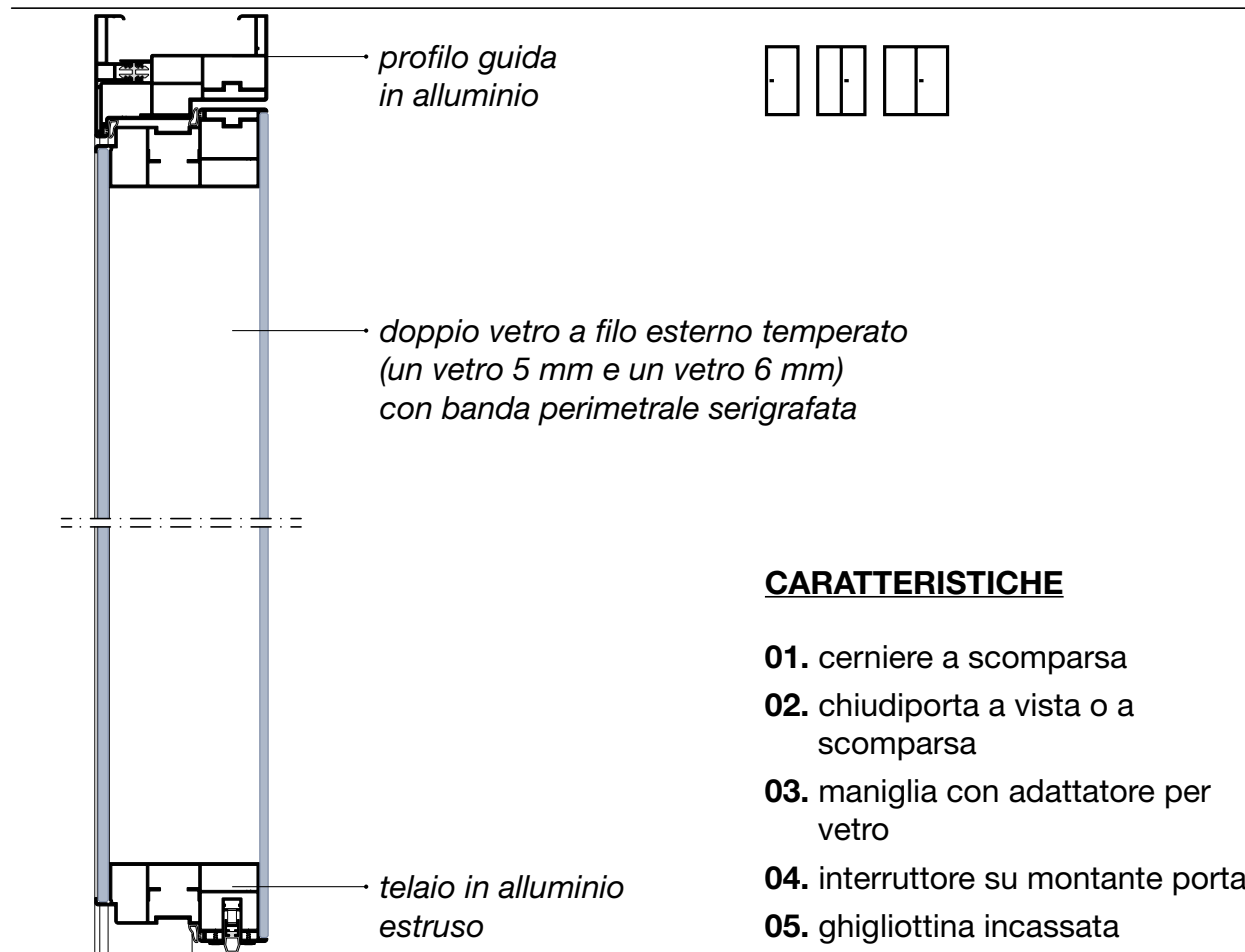

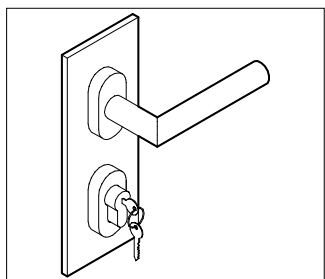

ML5

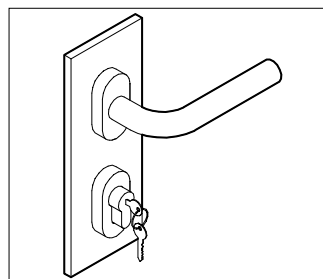

ML6

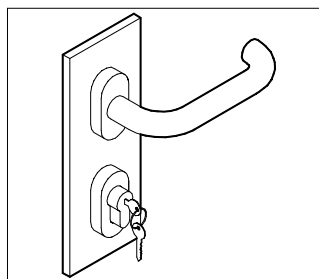

ML7

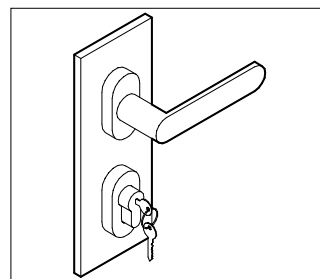

ML8

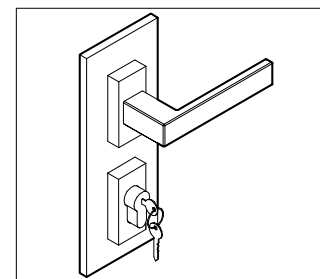

ML9

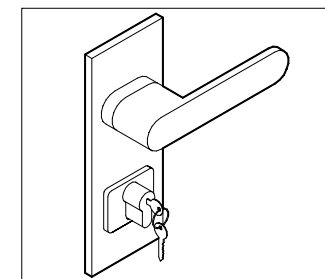

ML10

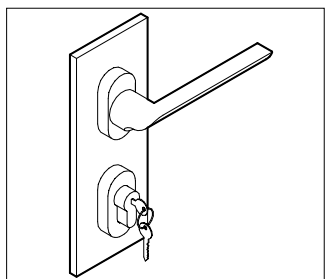

ML11

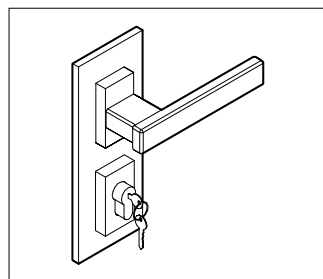

MLQ

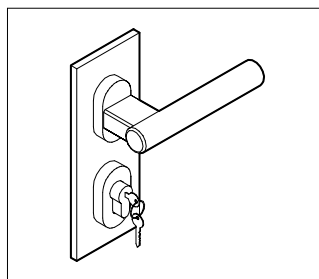

MLT

TELAI PORTE BATTENTI

Metrica strutturale



Telaio porta **Metrica Strutturale** su **Metrica D1**

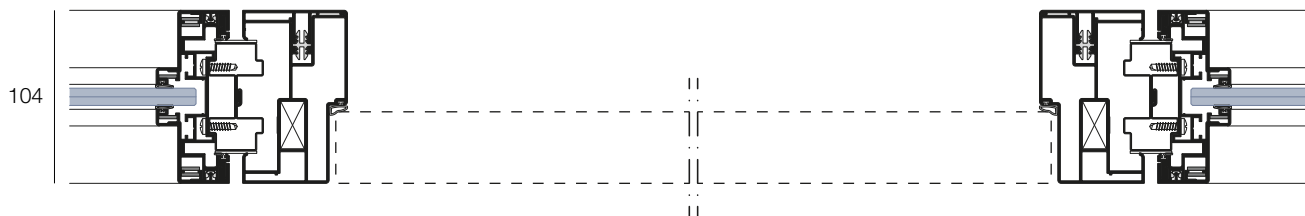

Telaio porta **Metrica Strutturale** su **Metrica D2**

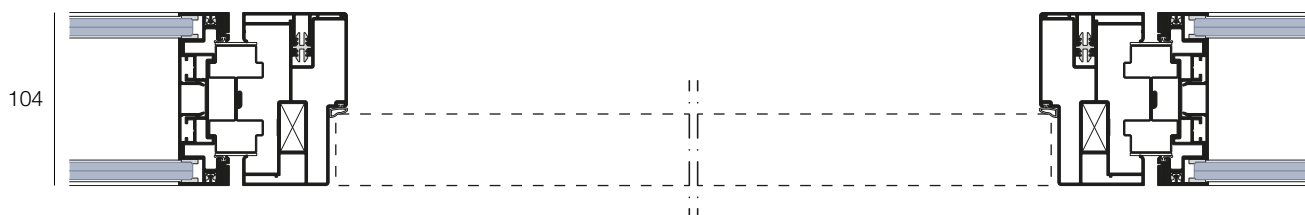

Telaio porta **Metrica Strutturale** su **Metrica Solid**

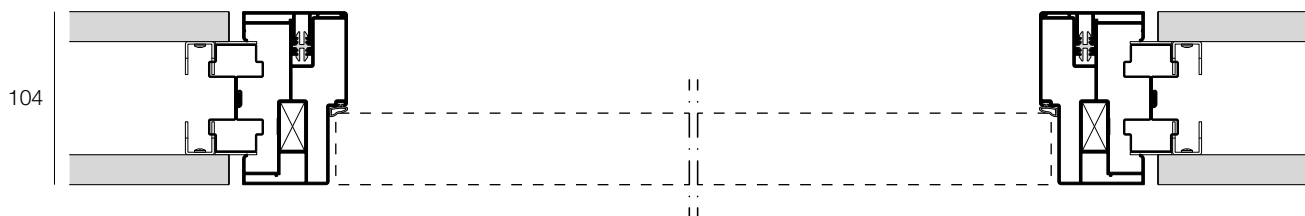

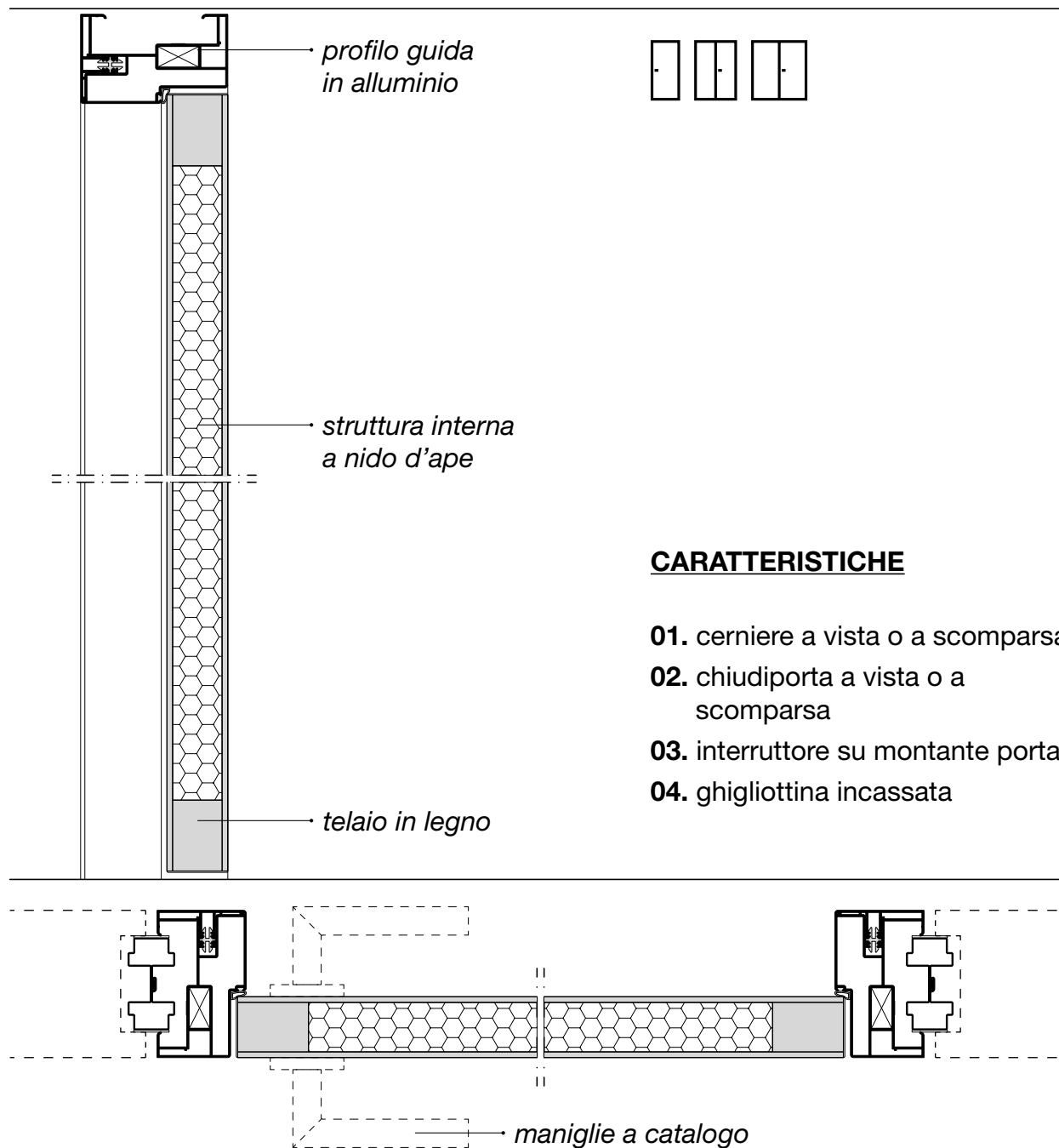

ANTA CIECA sp. 43 mm

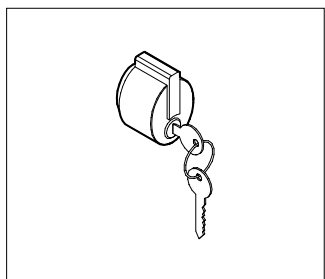

ML1

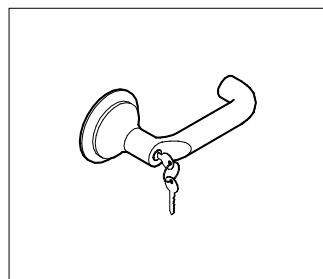

ML4

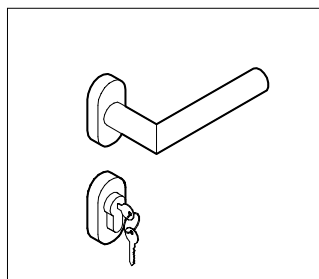

ML5

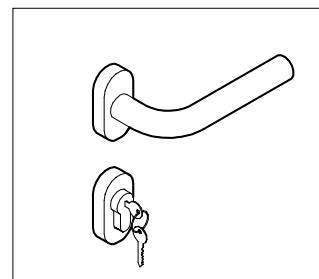

ML6

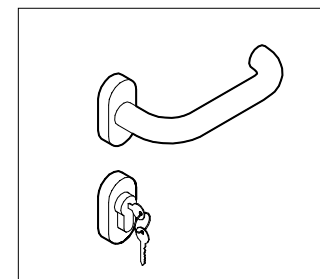

ML7

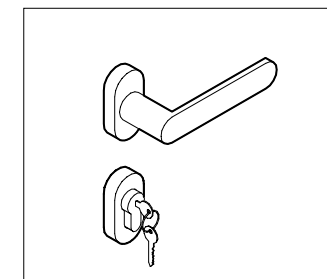

ML8

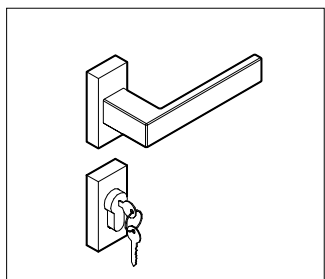

ML9

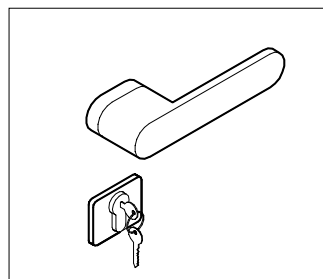

ML10

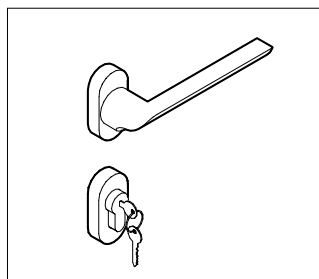

ML11

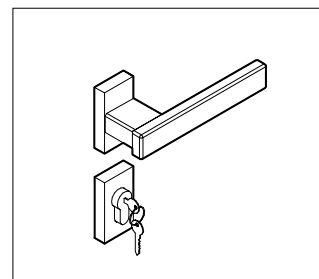

MLQ

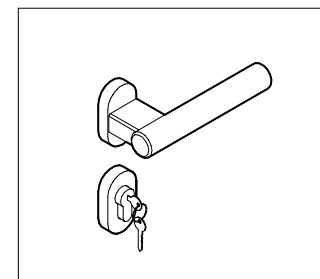

MLT

ANTA VETRO TEMPERATO_CERNIERE A VISTA sp. 10 mm

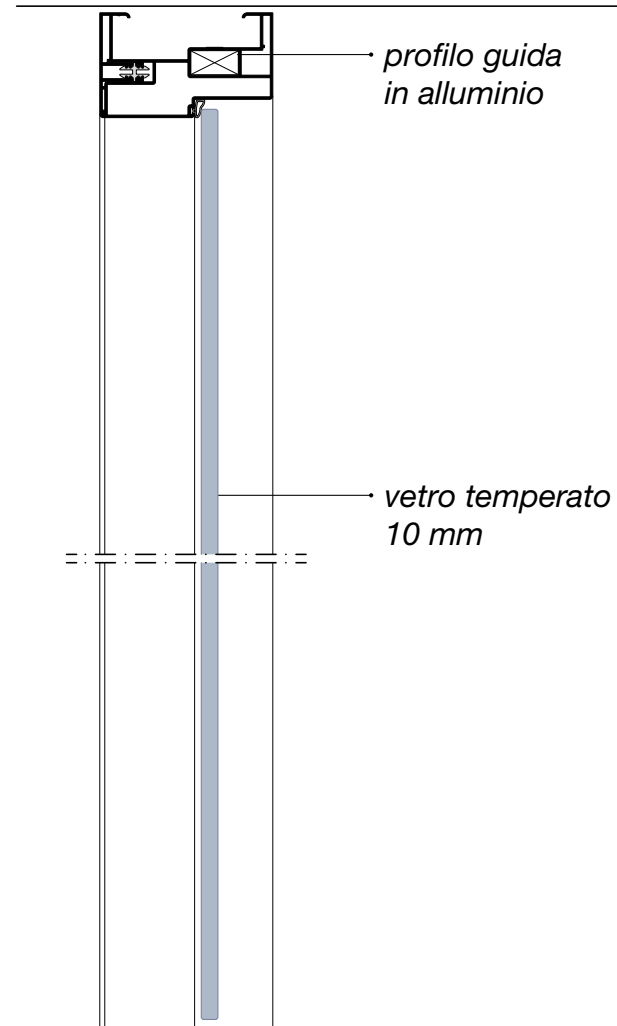
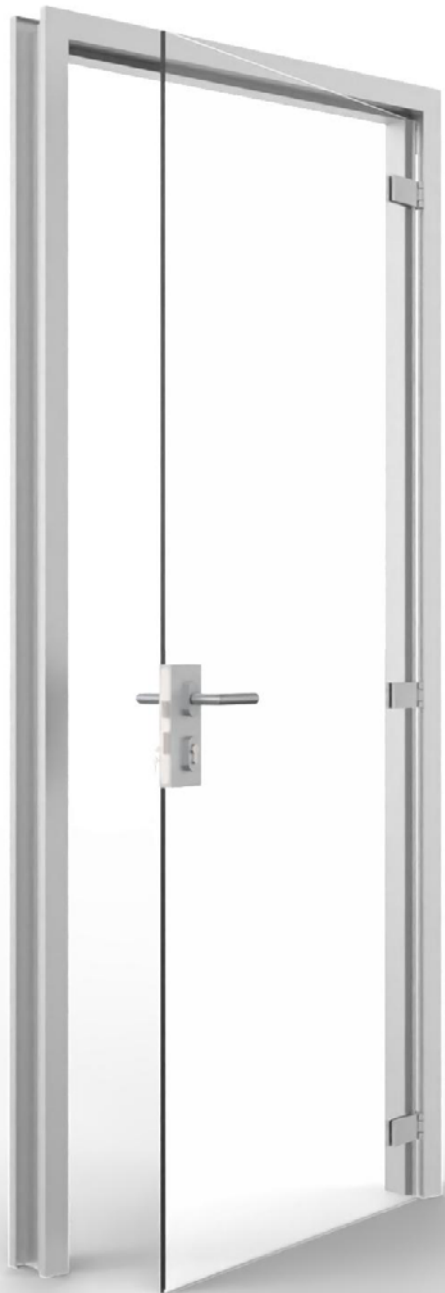

CARATTERISTICHE

- 01.** cerniere a vista - 110° o 180°
- 02.** chiudiporta a vista
- 03.** maniglia con adattatore per vetro
- 04.** interruttore su montante porta
- 05.** ghigliottina esterna

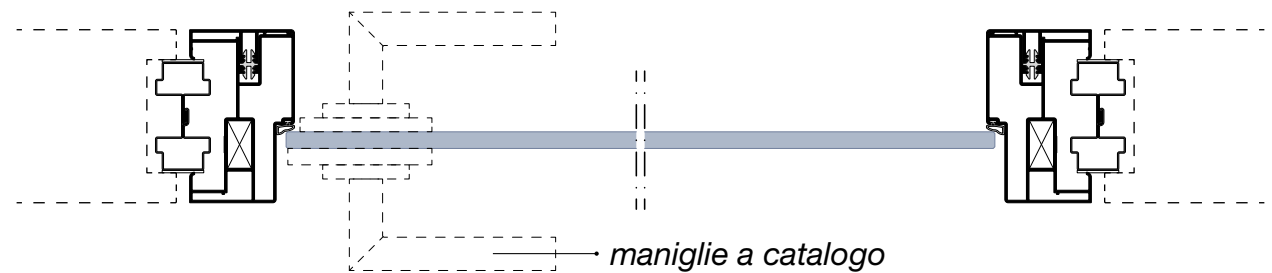

ANTA VETRO TEMPERATO_CERNIERE A VISTA sp. 10 mm

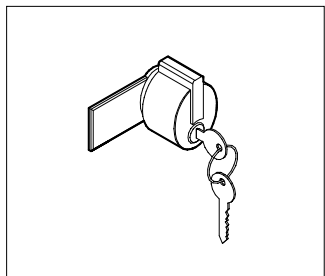

MC1

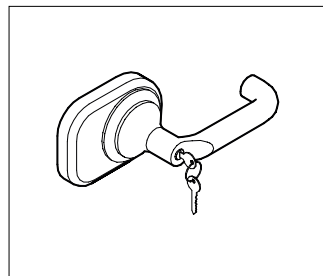

MC4

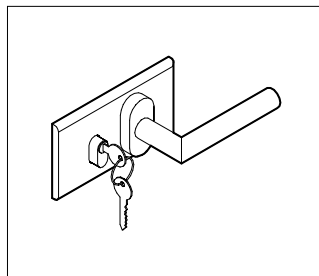

MC5

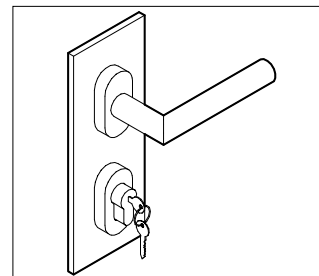

MC5V

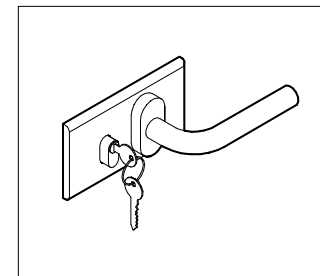

MC6

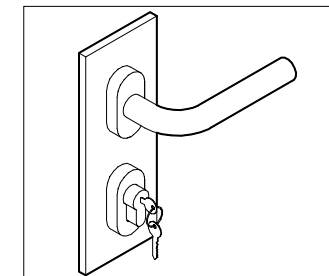

MC6V

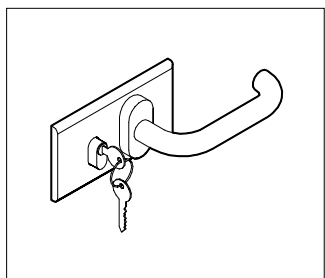

MC7

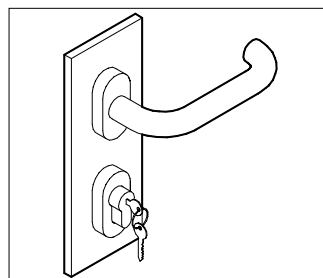

MC7V

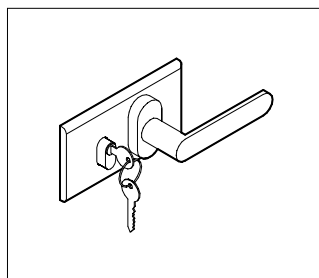

MC8

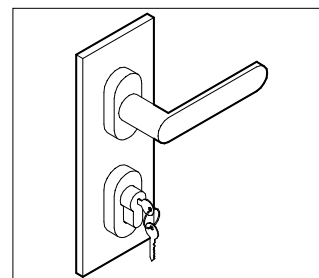

MC8V

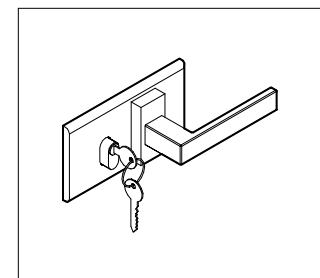

MC9

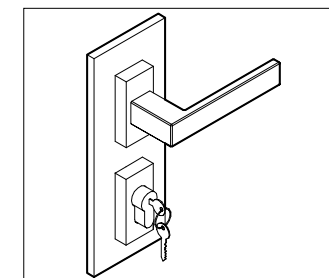

MC9V

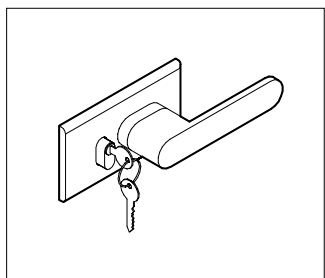

MC10

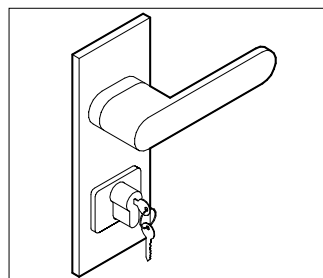

MC10V

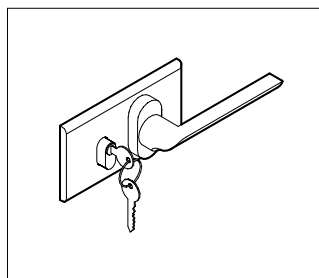

MC11

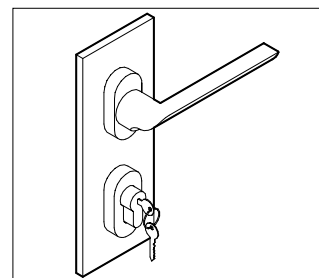

MC11V

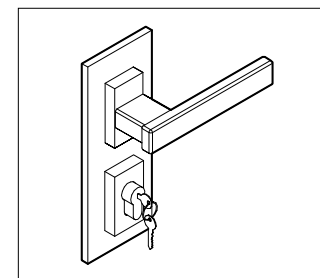

MCQ

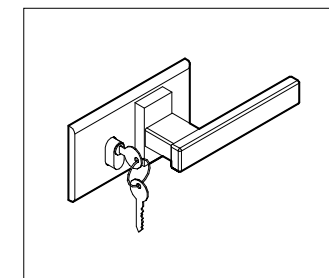

MCQO

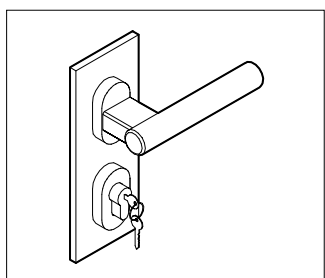

MCT

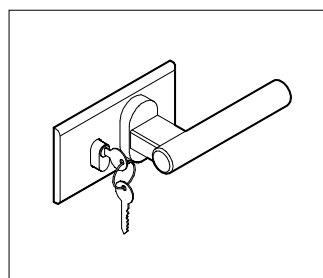

MCTO

ANTA VETRO TEMPERATO_CERNIERA CONTINUA sp. 10 mm

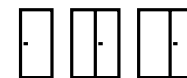
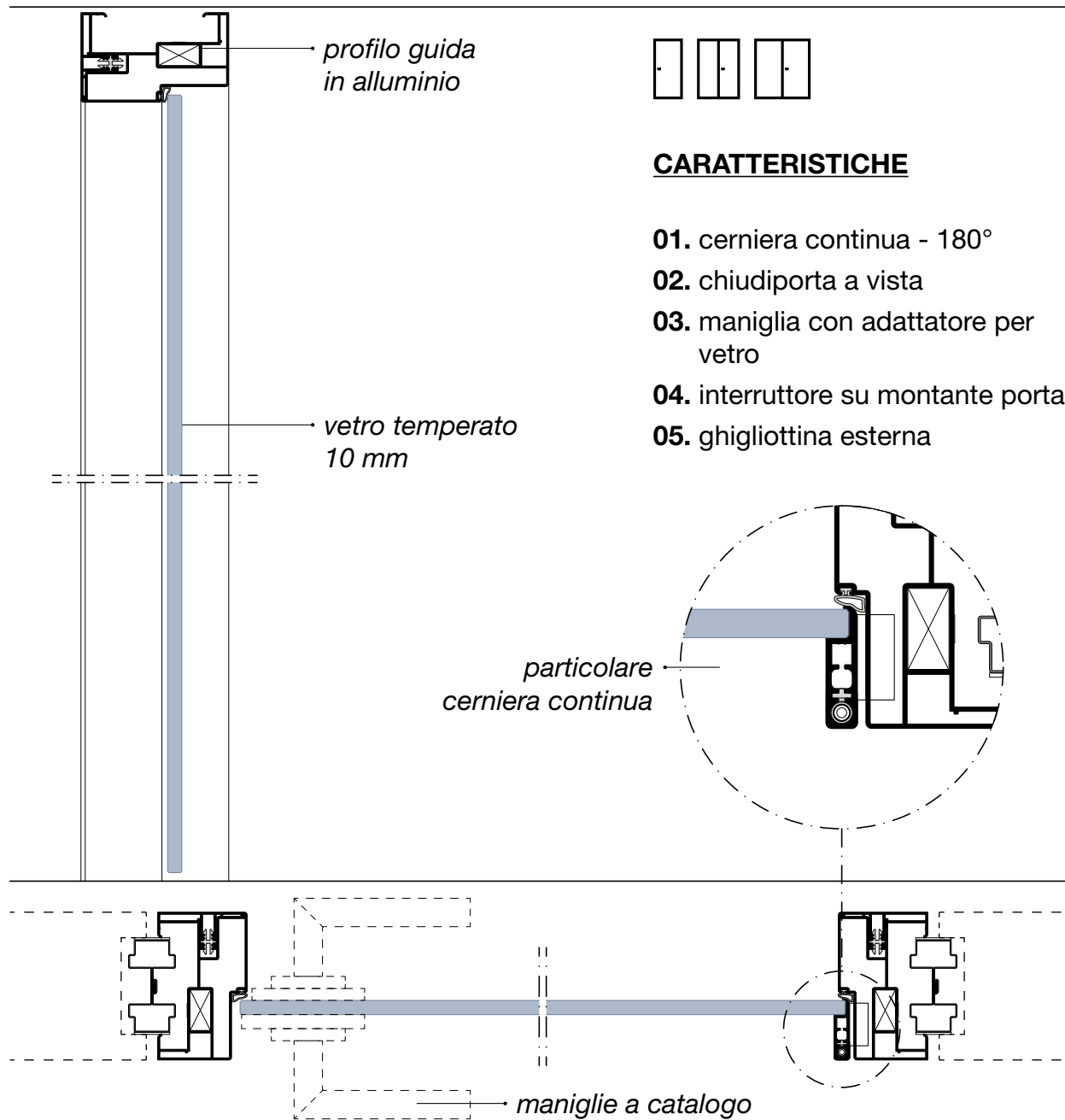
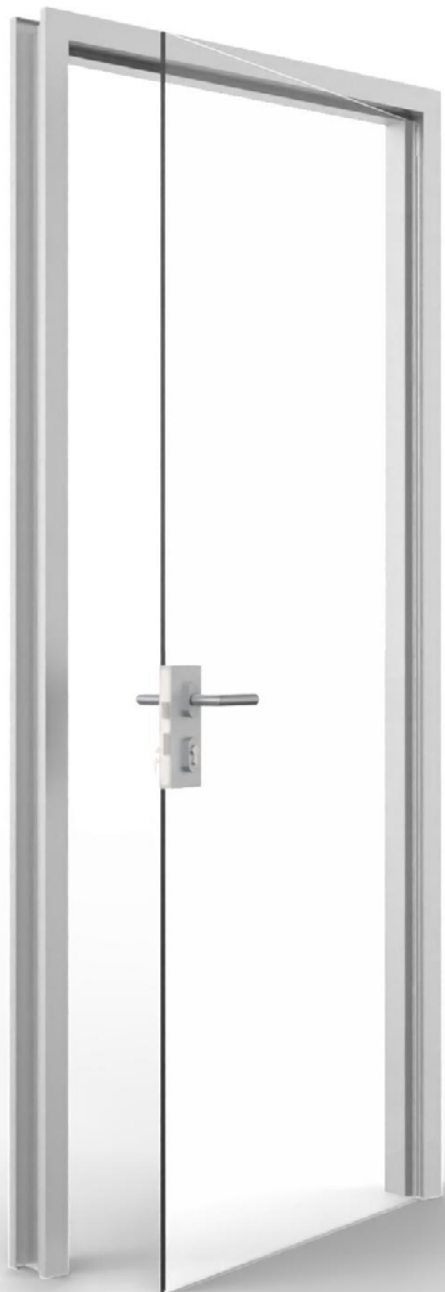

ANTA VETRO TEMPERATO_CERNIERA CONTINUA sp. 10 mm

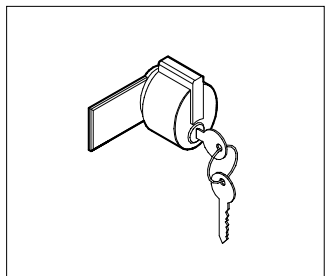

MC1

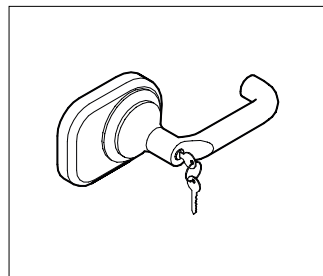

MC4

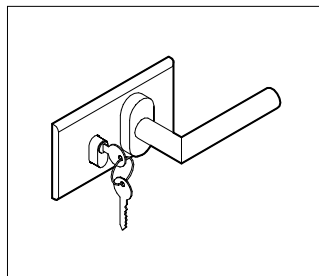

MC5

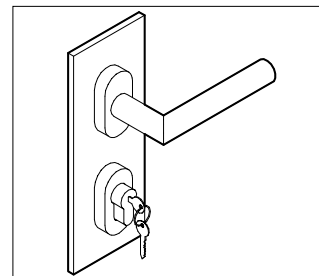

MC5V

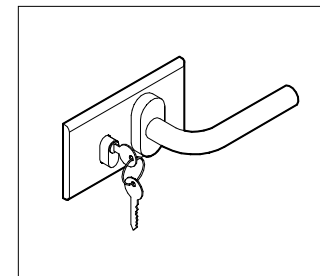

MC6

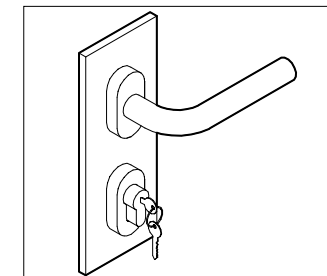

MC6V

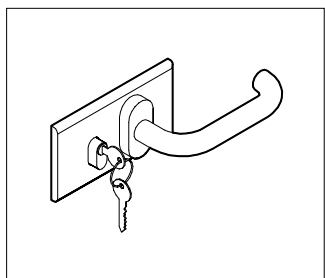

MC7

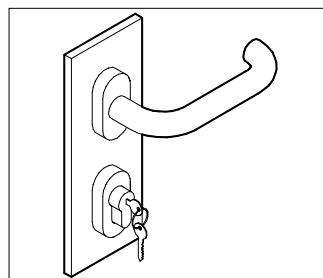

MC7V

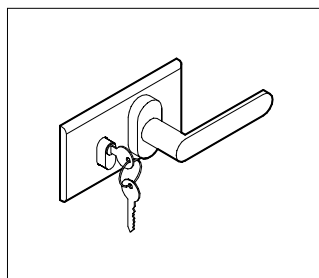

MC8

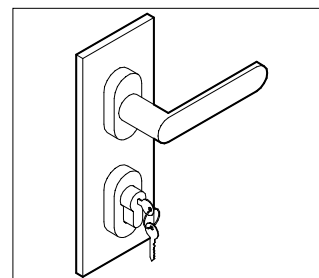

MC8V

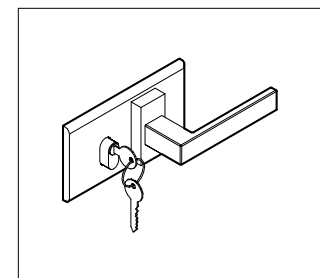

MC9

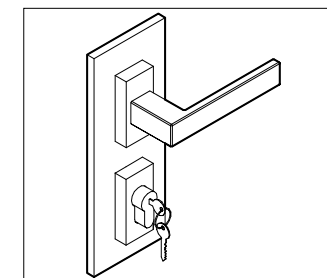

MC9V

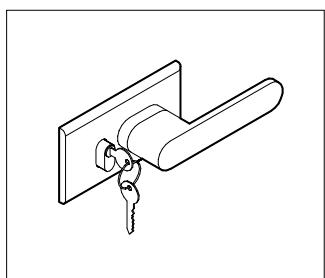

MC10

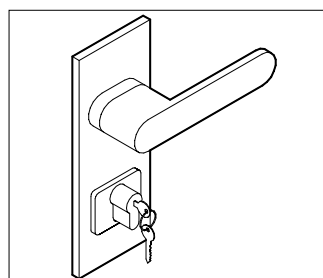

MC10V

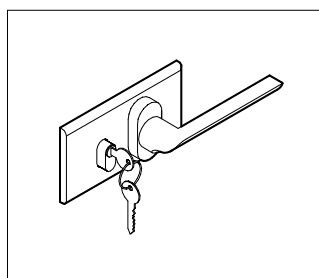

MC11

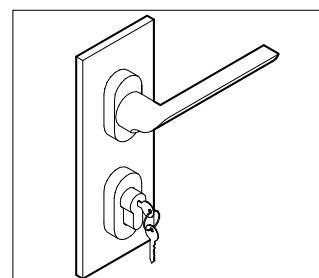

MC11V

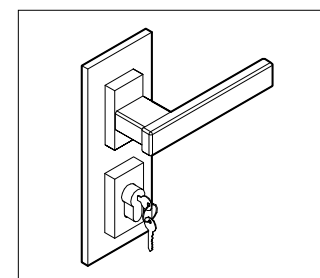

MCQ

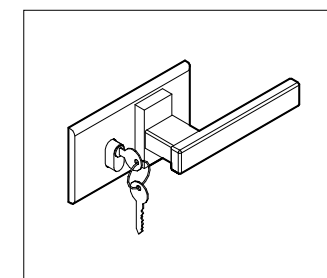

MCQO

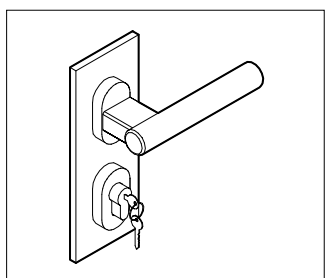

MCT

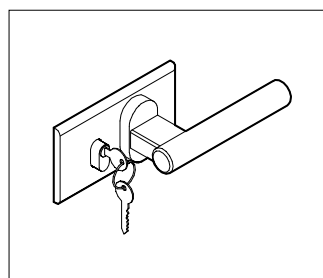

MCTO

ANTA INTELAIATA GRANDE CON PANNELLO sp. 43 mm

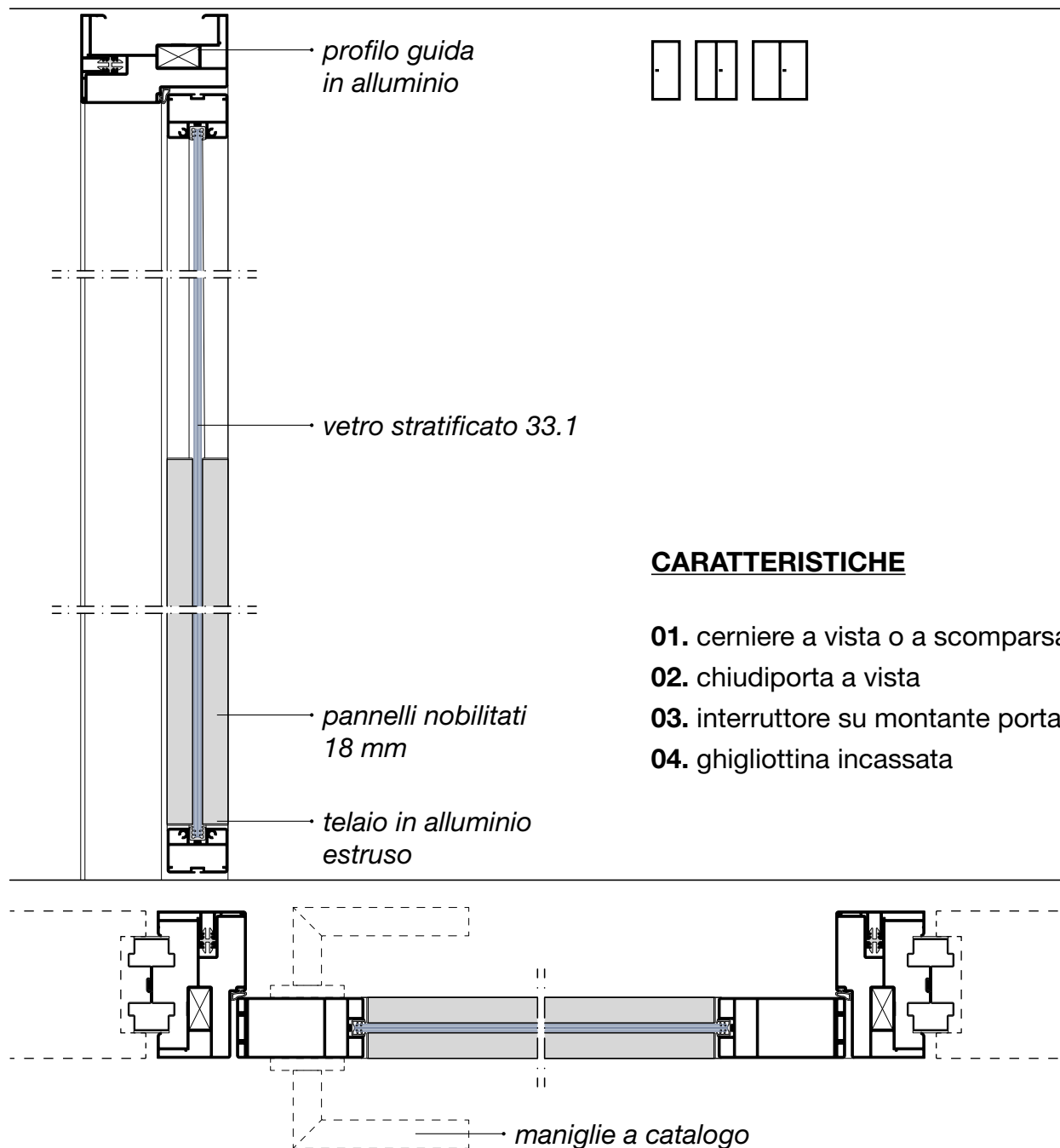

ANTA INTELAIATA GRANDE CON PANNELLO sp. 43 mm

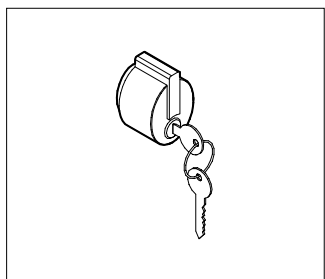

ML1

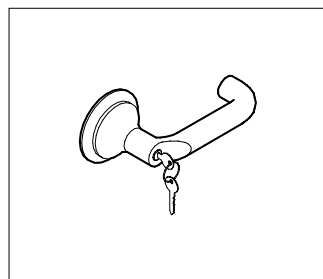

ML4

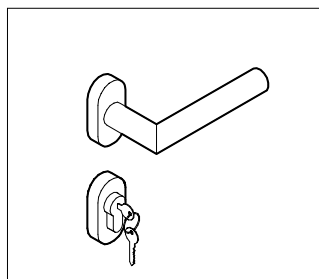

ML5

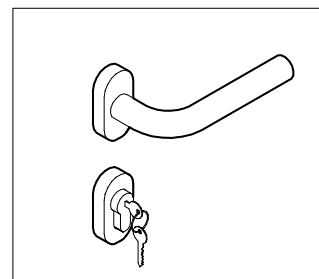

ML6

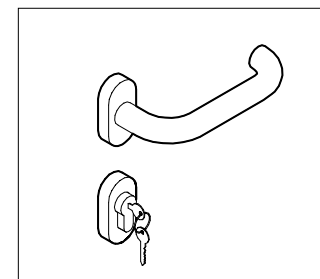

ML7

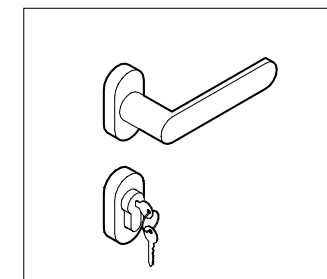

ML8

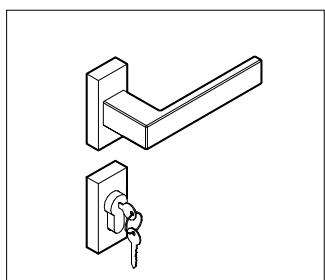

ML9

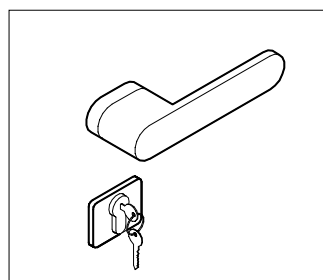

ML10

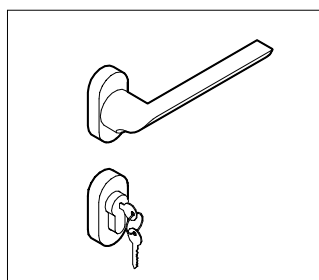

ML11

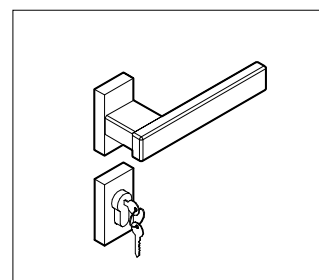

MLQ

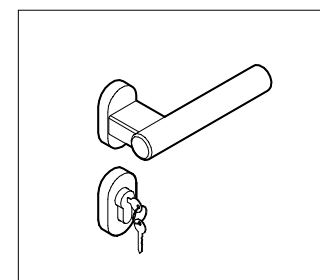

MLT

ANTA INTELAIATA GRANDE sp. 43 mm

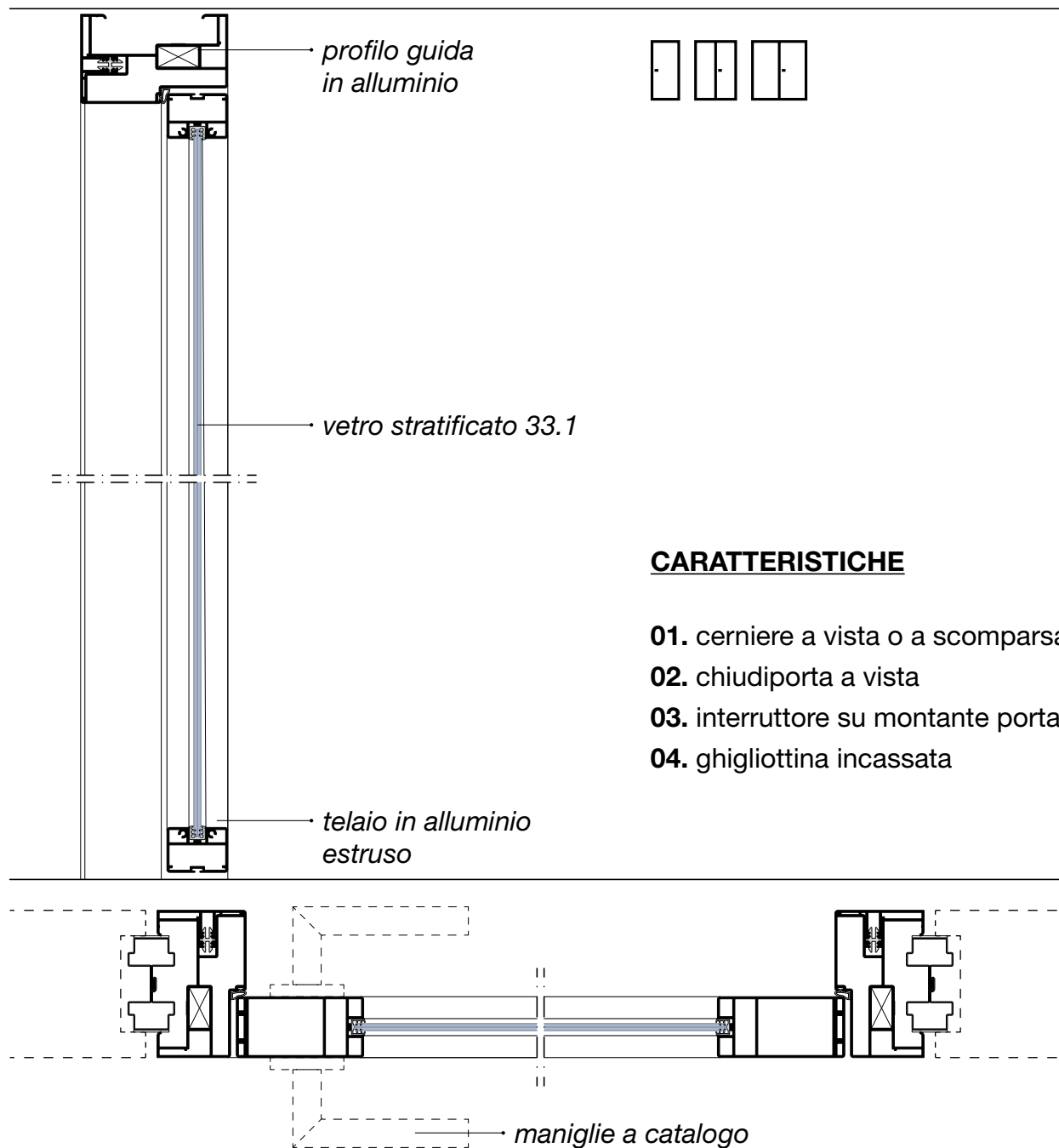

ANTA INTELAIATA GRANDE sp. 43 mm

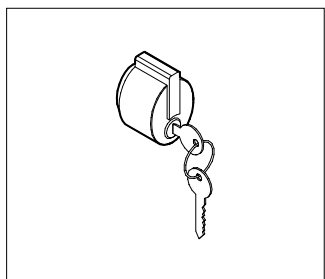

ML1

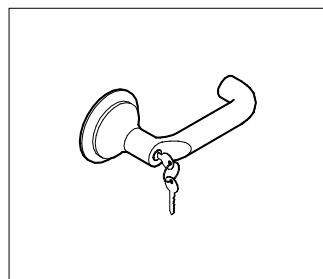

ML4

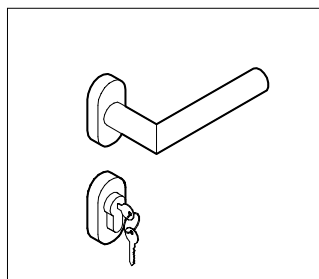

ML5

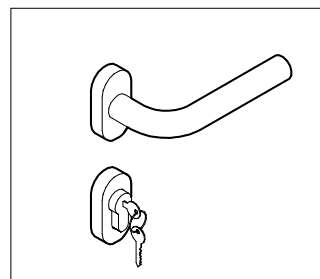

ML6

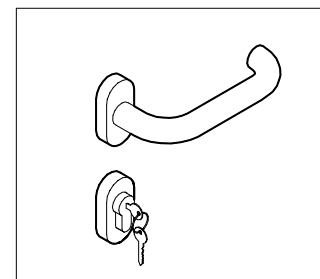

ML7

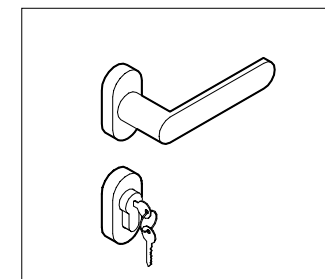

ML8

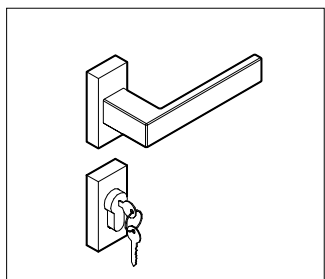

ML9

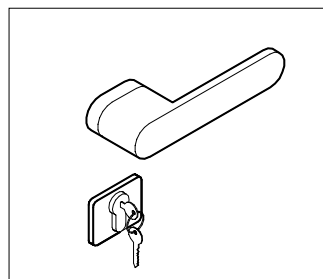

ML10

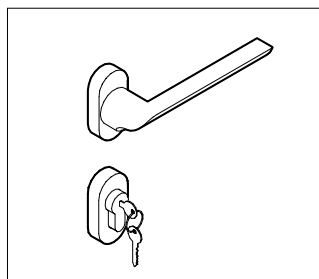

ML11

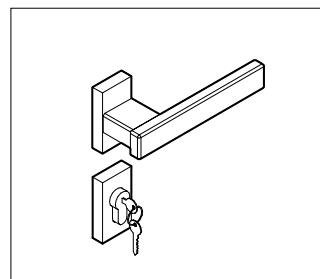

MLQ

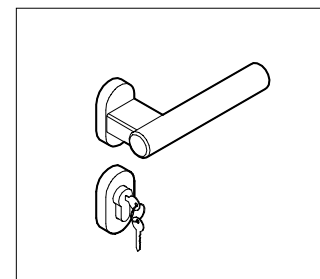

MLT

ANTA INTELAIATA MEDIA sp. 43 mm

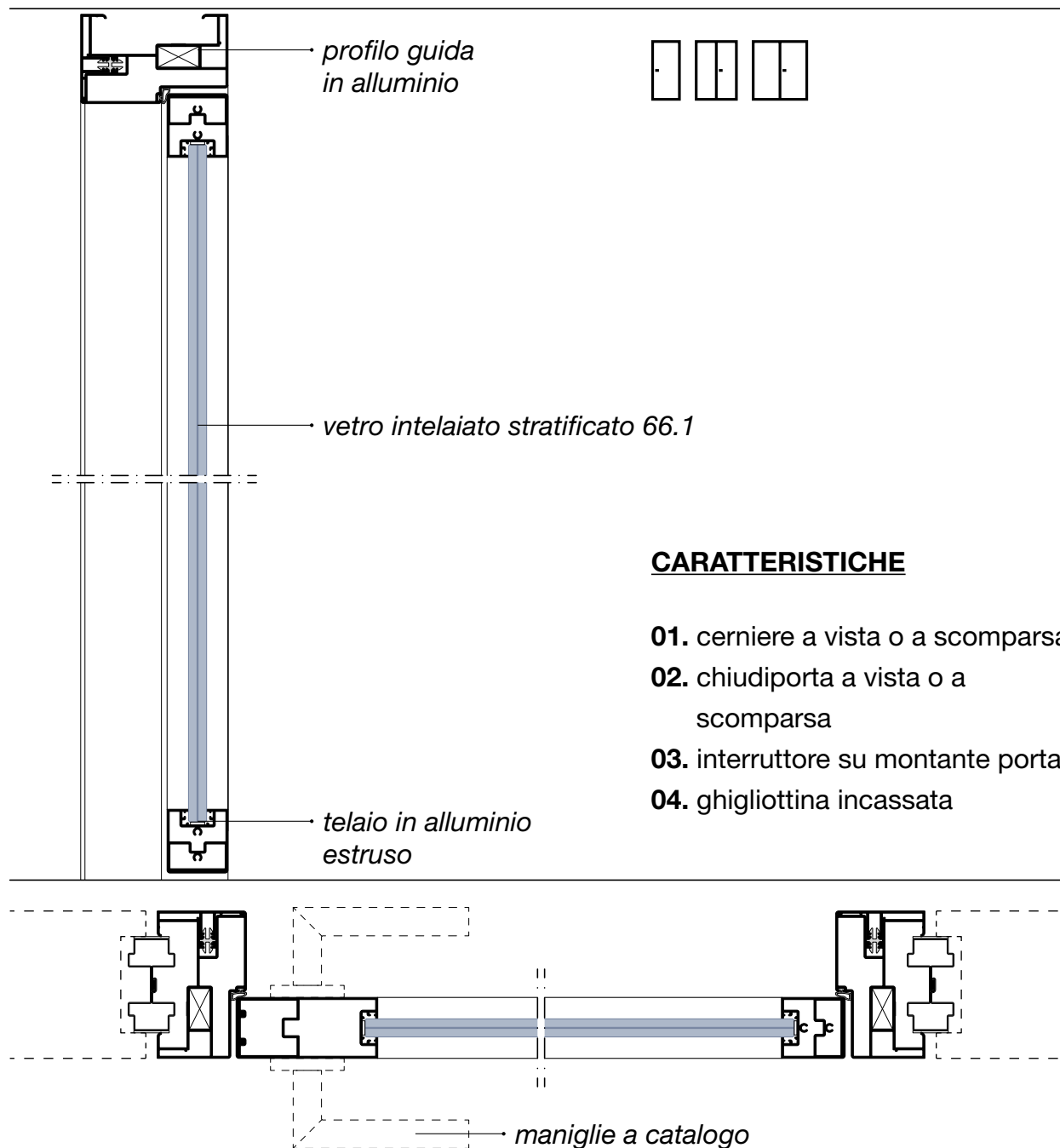

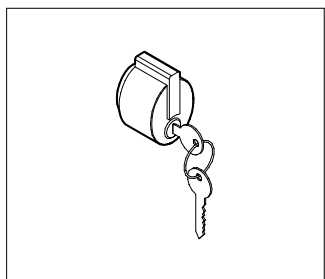

ML1

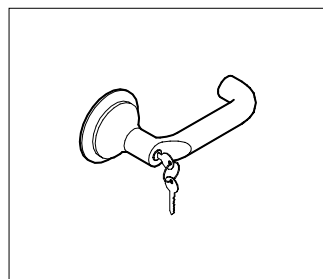

ML4

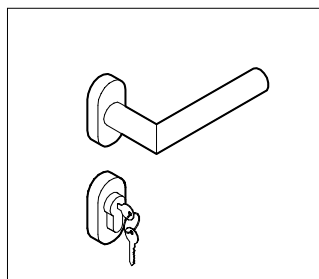

ML5

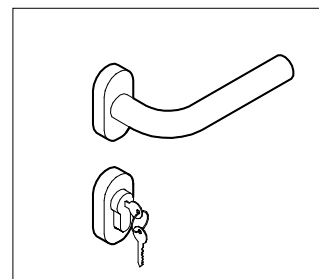

ML6

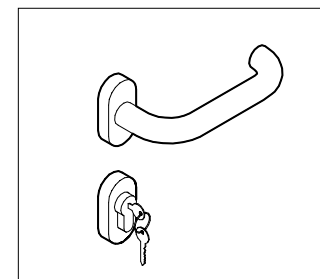

ML7

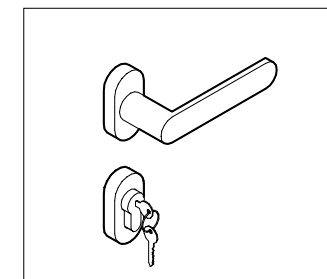

ML8

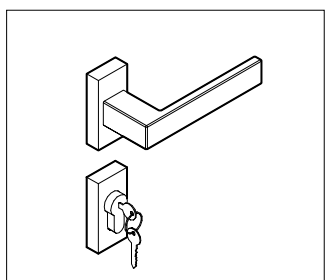

ML9

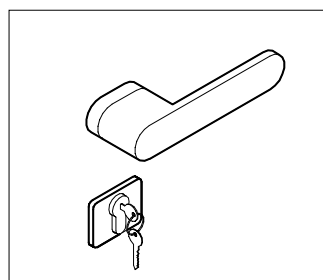

ML10

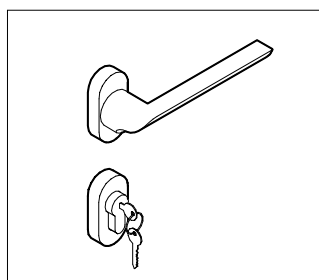

ML11

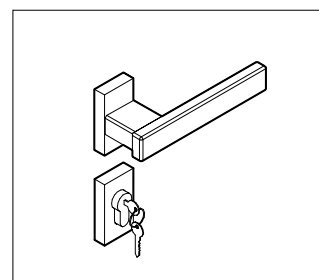

MLQ

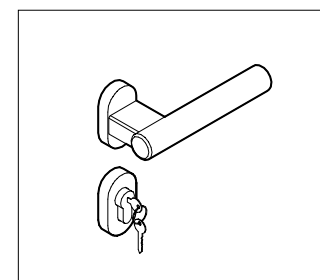

MLT

ANTA INTELAIATA SOTTILE sp. 43 mm

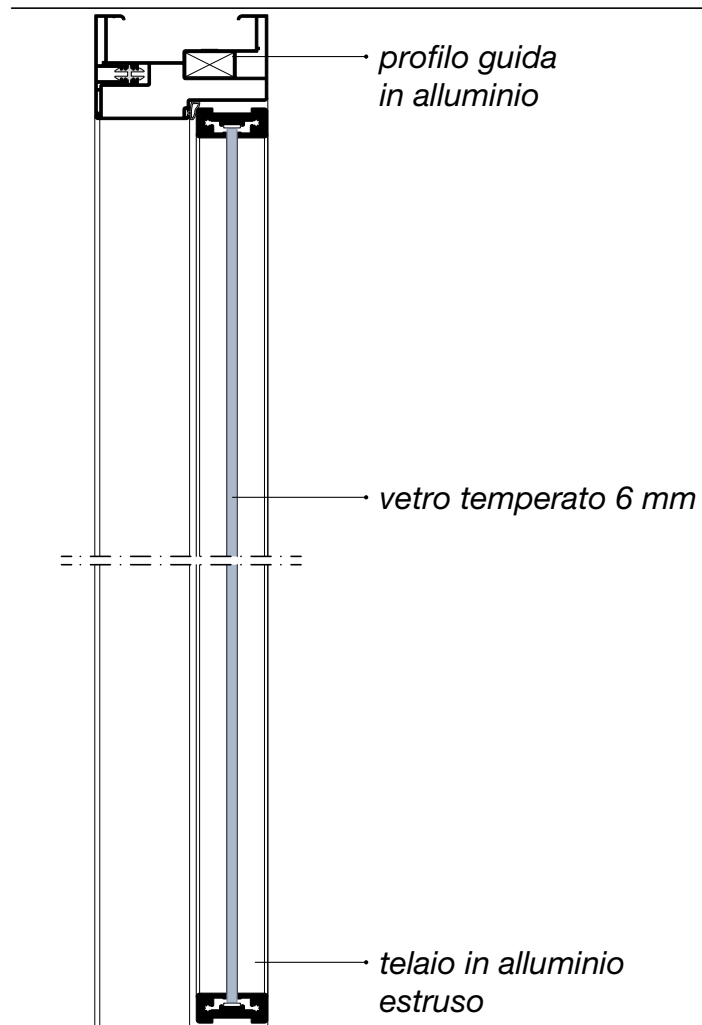

CARATTERISTICHE

- 01. cerniere a vista
- 02. chiudiporta a vista
- 03. maniglia con adattatore per vetro
- 04. interruttore su montante porta

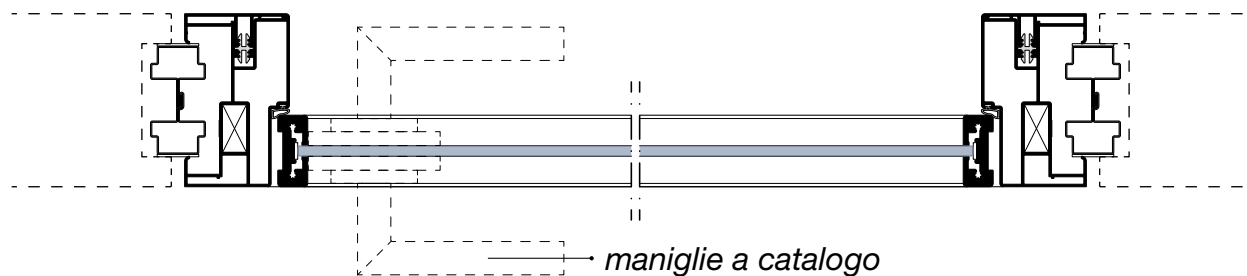

ANTA INTELAIATA SOTTILE sp. 43 mm

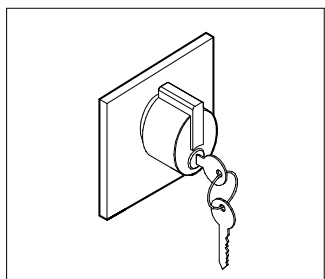

ML1

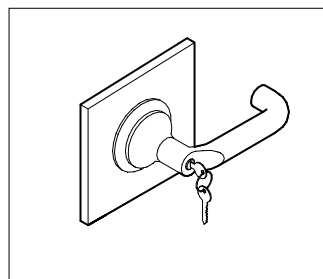

ML4

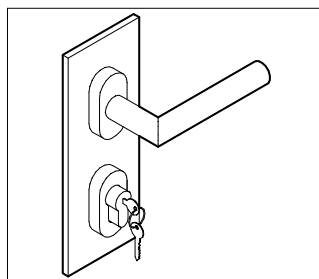

ML5

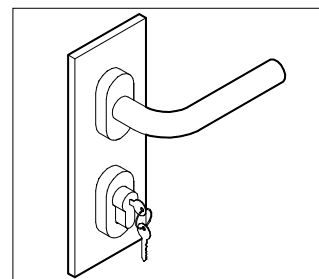

ML6

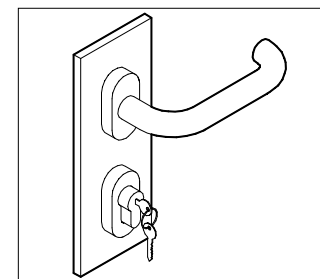

ML7

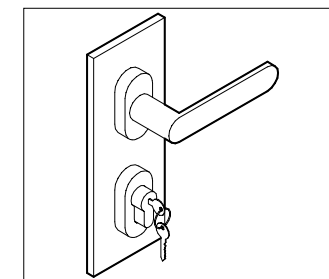

ML8

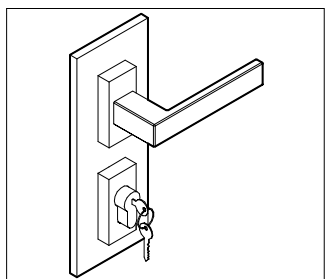

ML9

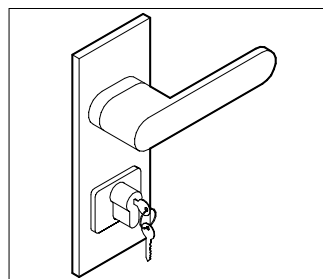

ML10

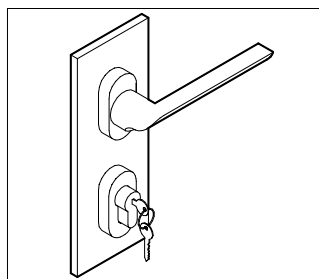

ML11

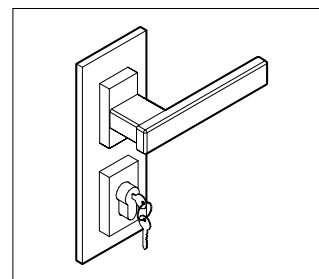

MLQ

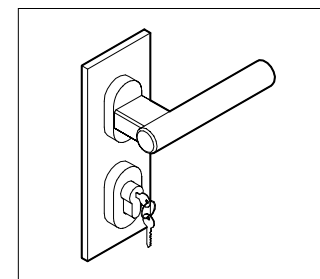

MLT

ANTA INTELAIATA VETRO DOPPIO sp. 51 mm

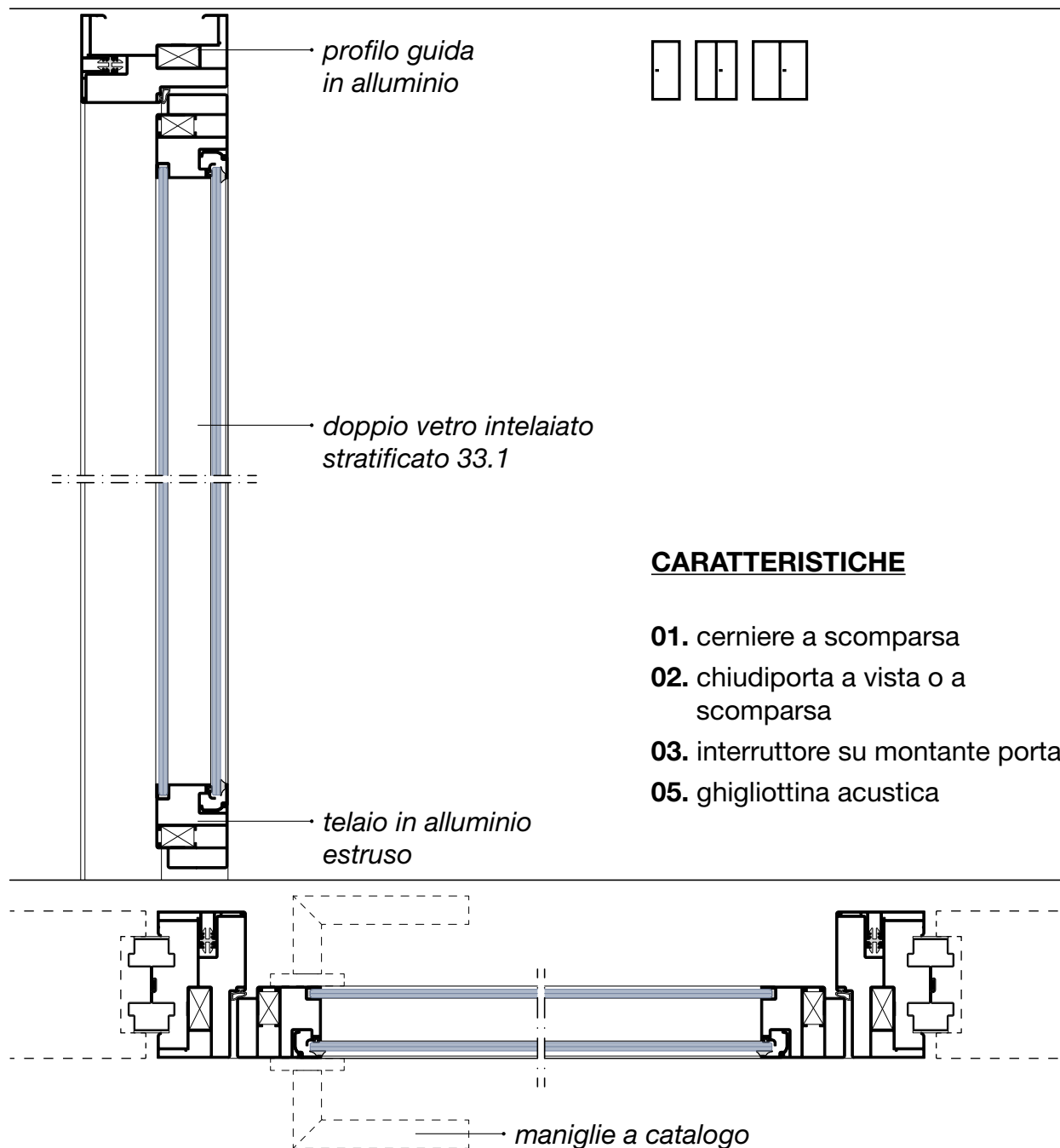

ANTA INTELAIATA VETRO DOPPIO sp. 51 mm

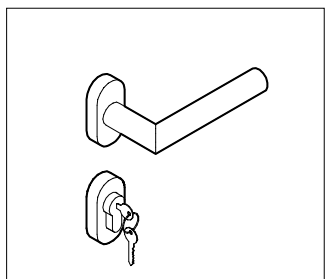

ML5

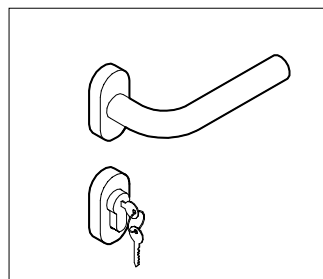

ML6

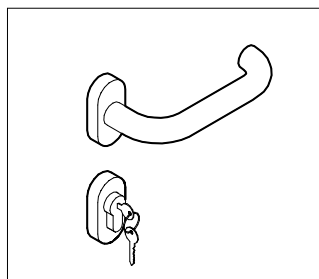

ML7

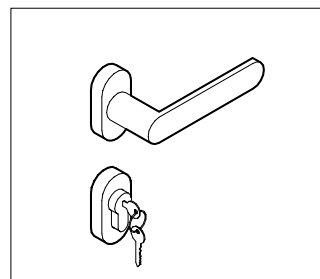

ML8

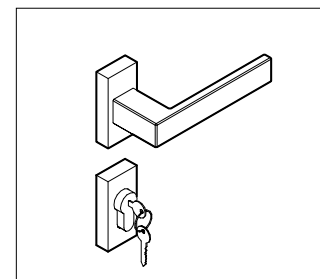

ML9

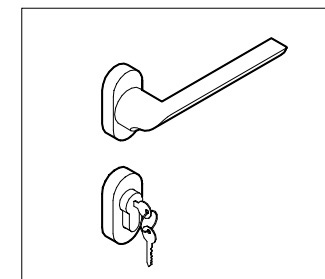

ML11

ANTA INTELAIATA CIECA sp. 104 mm

Porta complanare

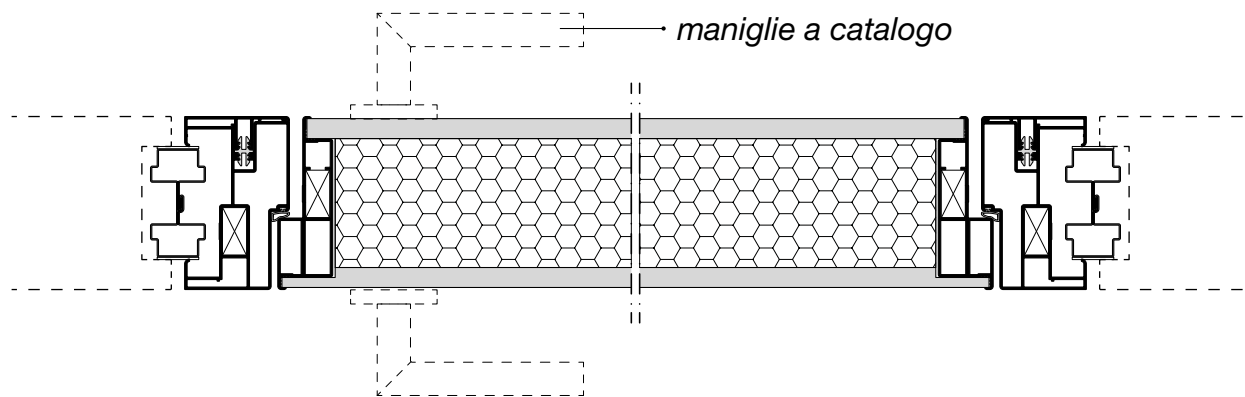
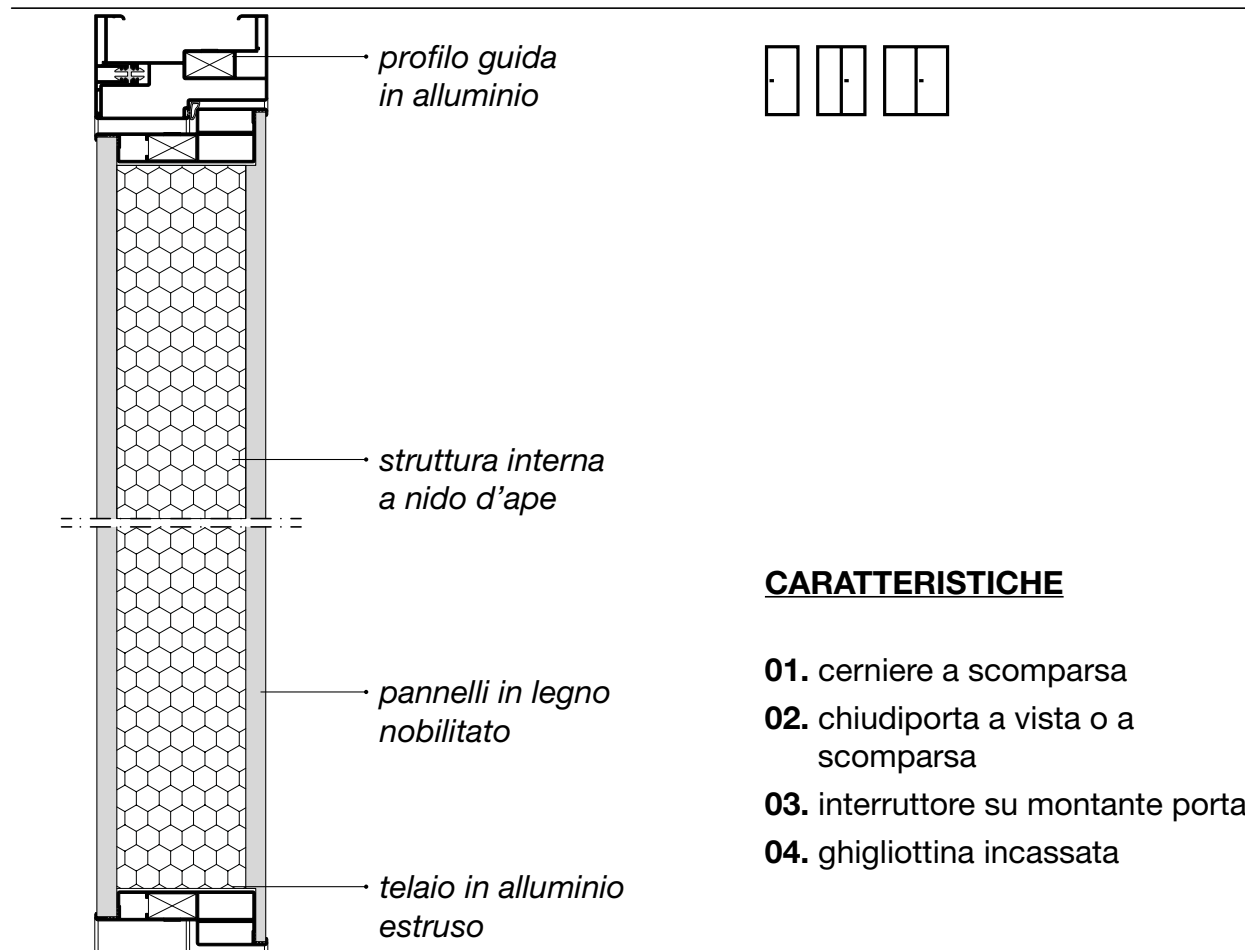

ANTA INTELAIATA CIECA sp. 104 mm

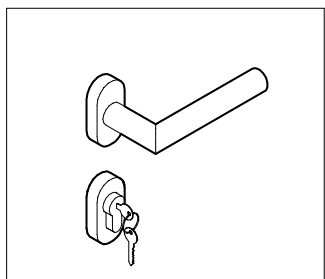

ML5

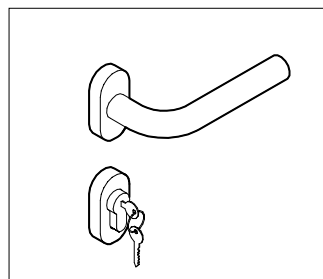

ML6

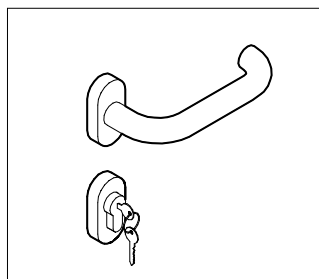

ML7

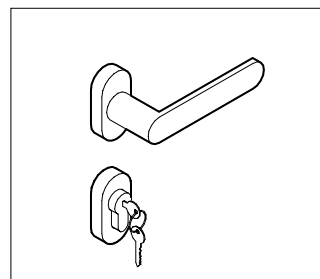

ML8

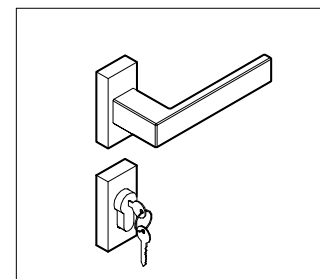

ML9

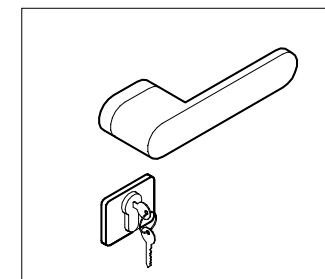

ML10

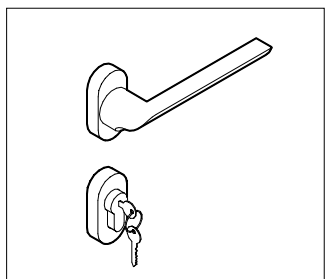

ML11

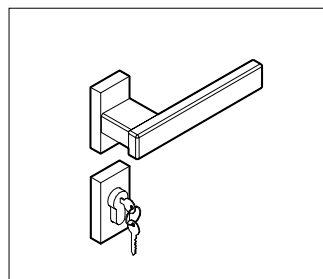

MLQ

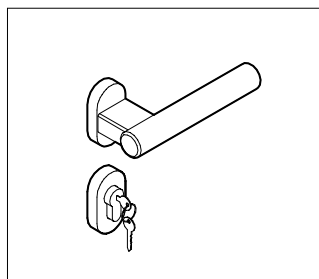

MLT

ANTA INTELAIATA VETRO DOPPIO sp. 104 mm

Porta complanare

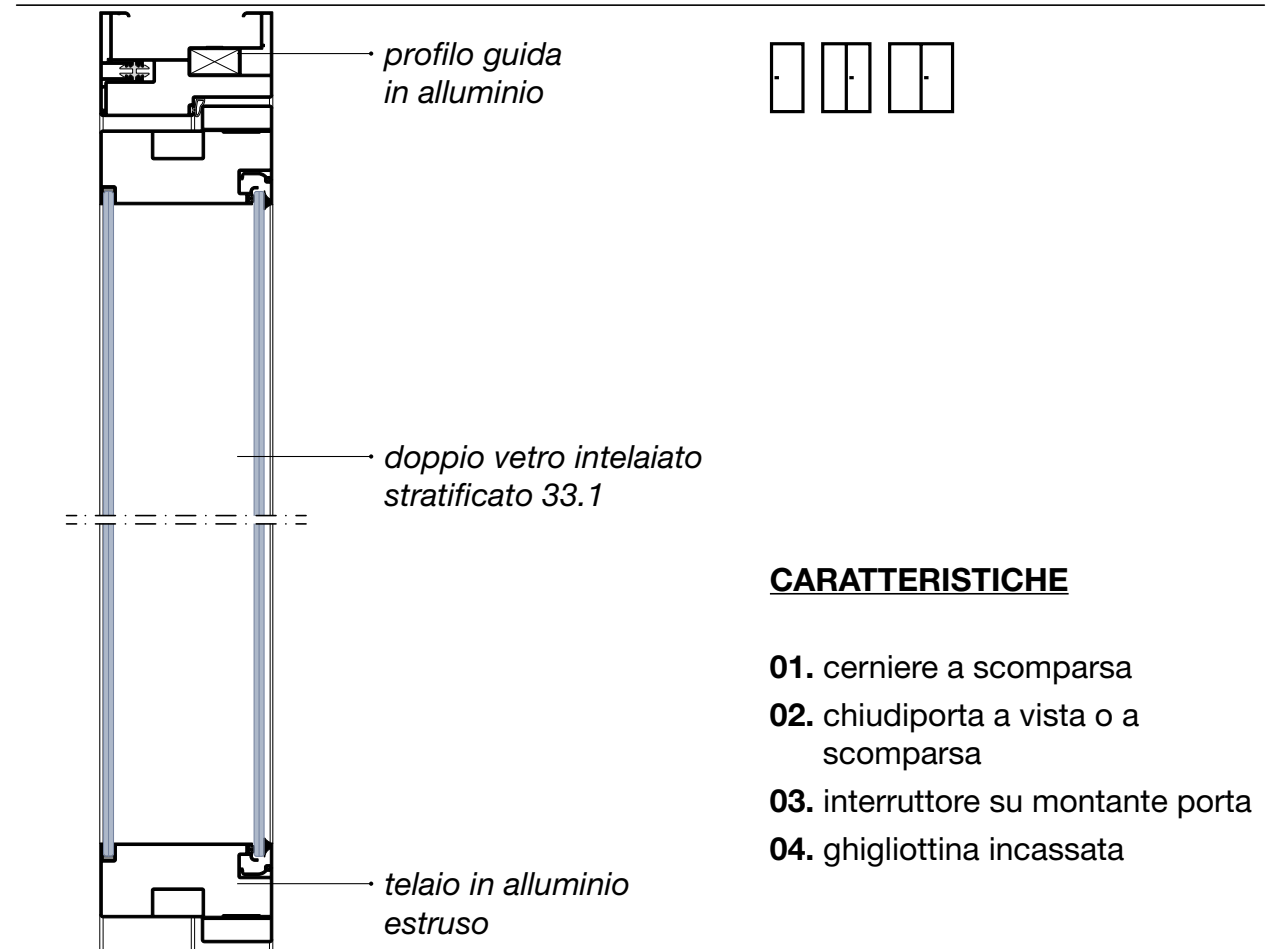

CARATTERISTICHE

- 01. cerniere a scomparsa
- 02. chiudiporta a vista o a scomparsa
- 03. interruttore su montante porta
- 04. ghigliottina incassata

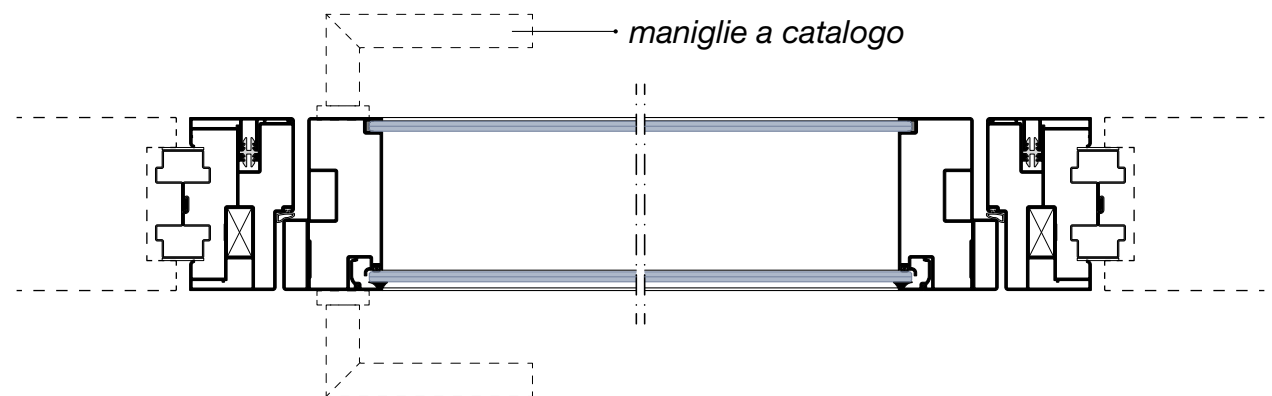

ANTA INTELAIATA VETRO DOPPIO sp. 104 mm

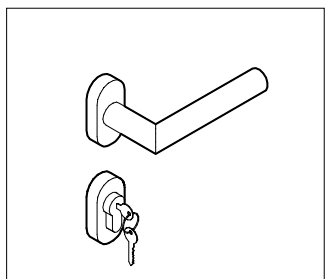

ML5

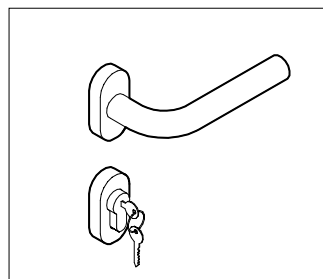

ML6

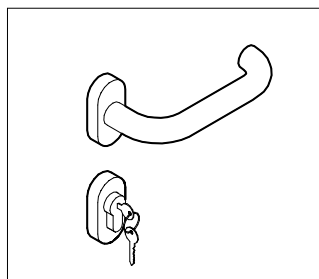

ML7

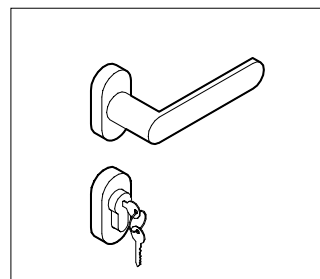

ML8

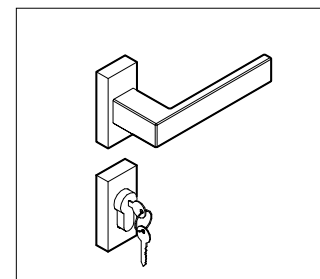

ML9

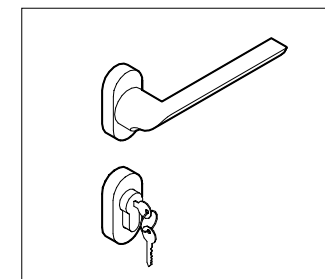

ML11

TELAI PORTE SCORREVOLI



Telaio porta **Metrica Strutturale** su **Metrica D1**

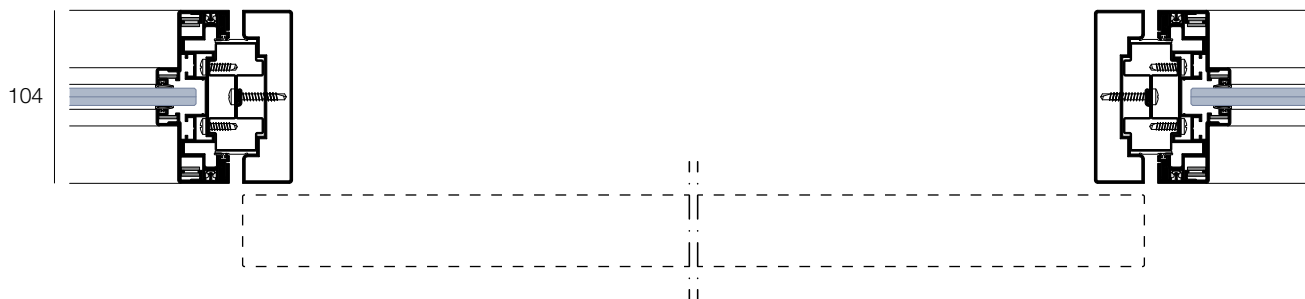

Telaio porta **Metrica Strutturale** su **Metrica D2**

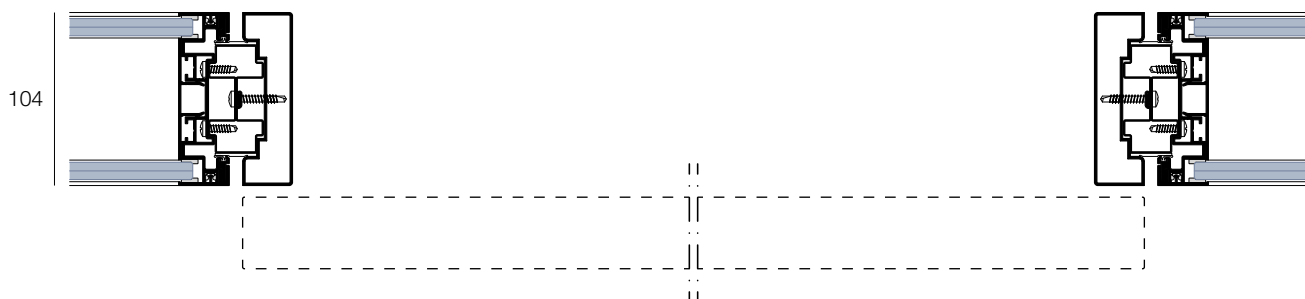

Telaio porta **Metrica Strutturale** su **Metrica Solid**

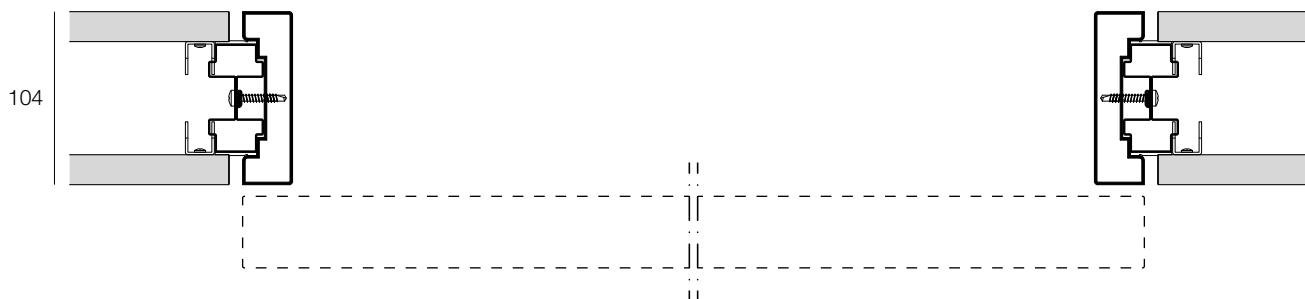

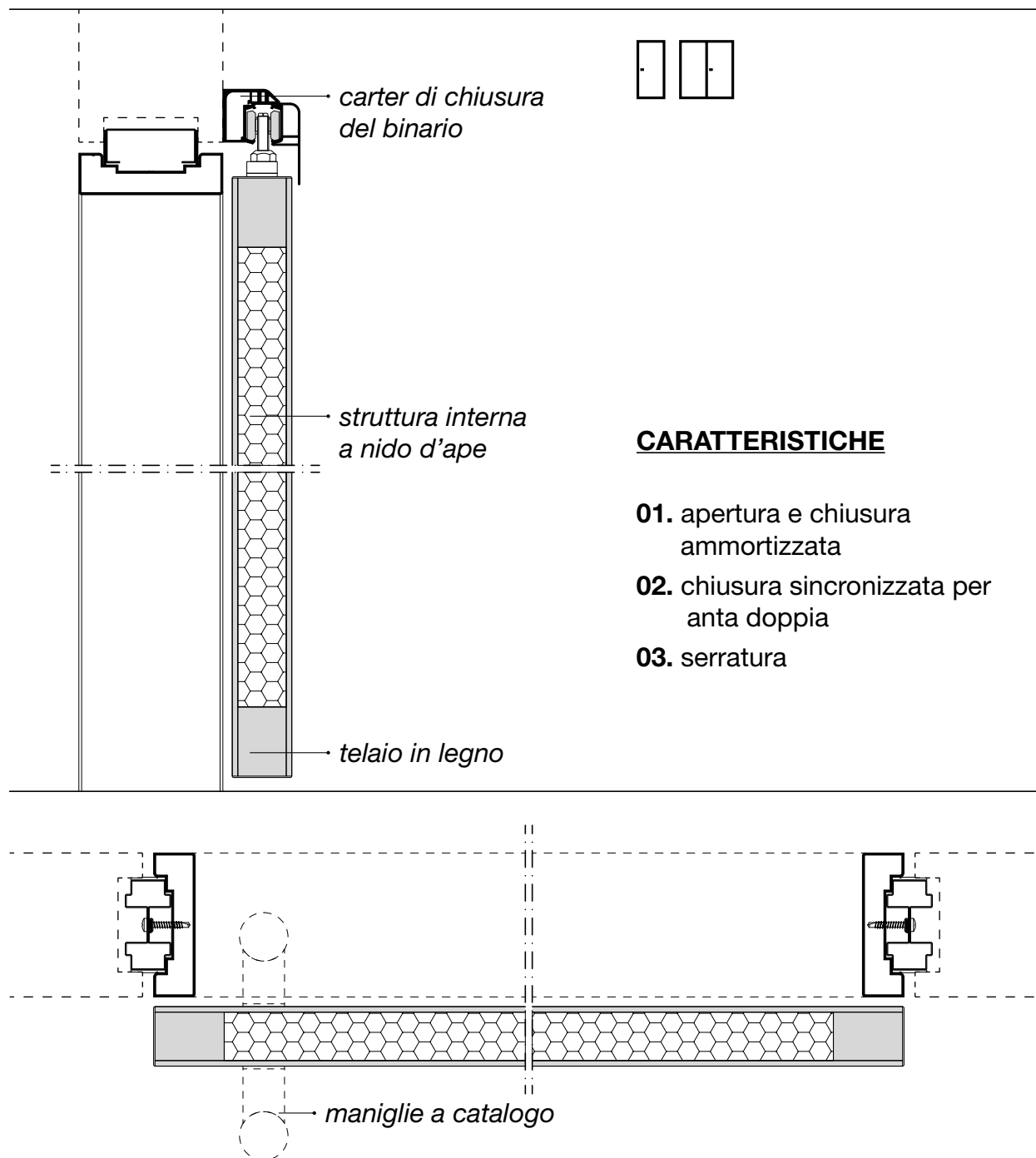

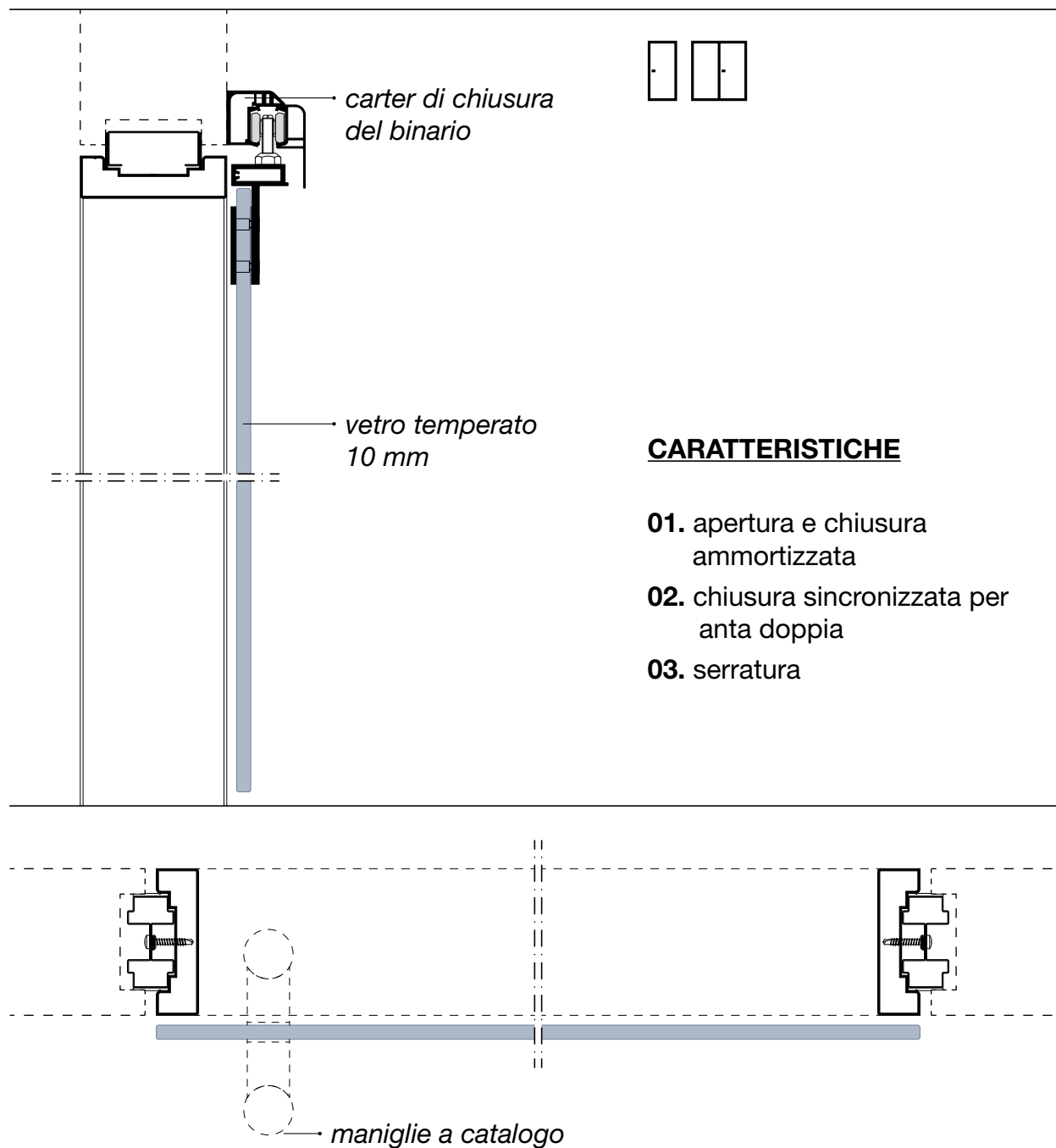

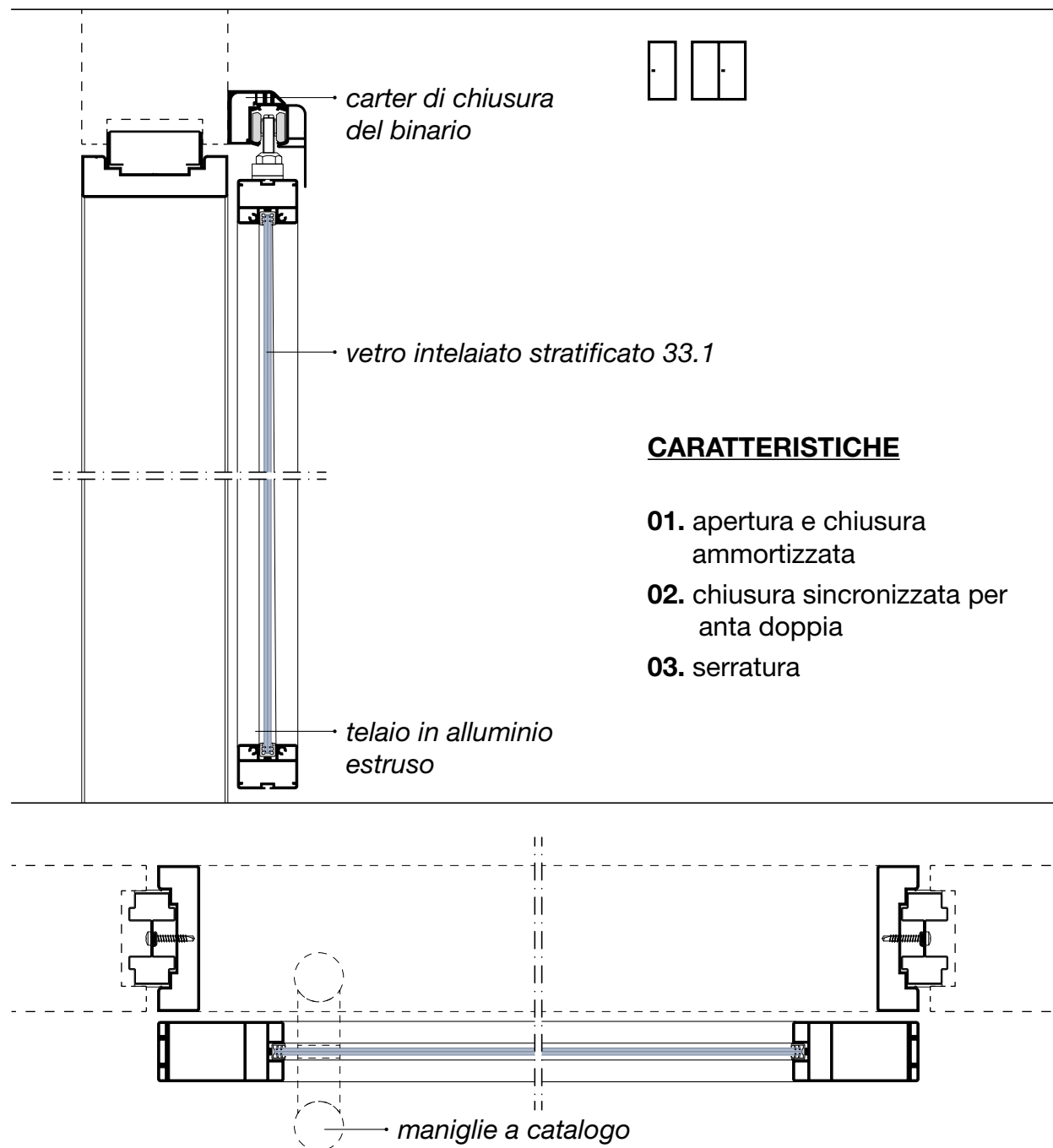

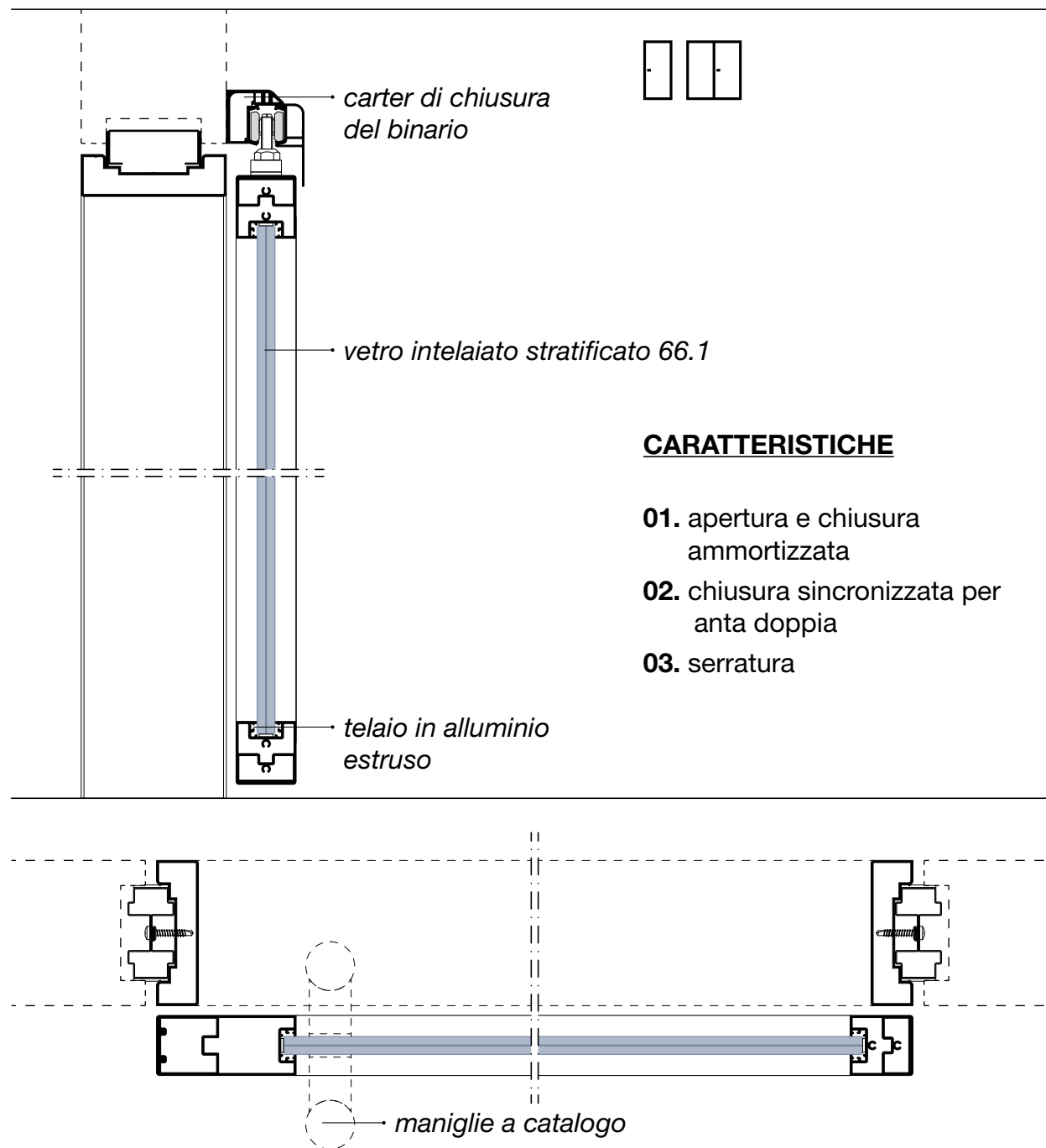

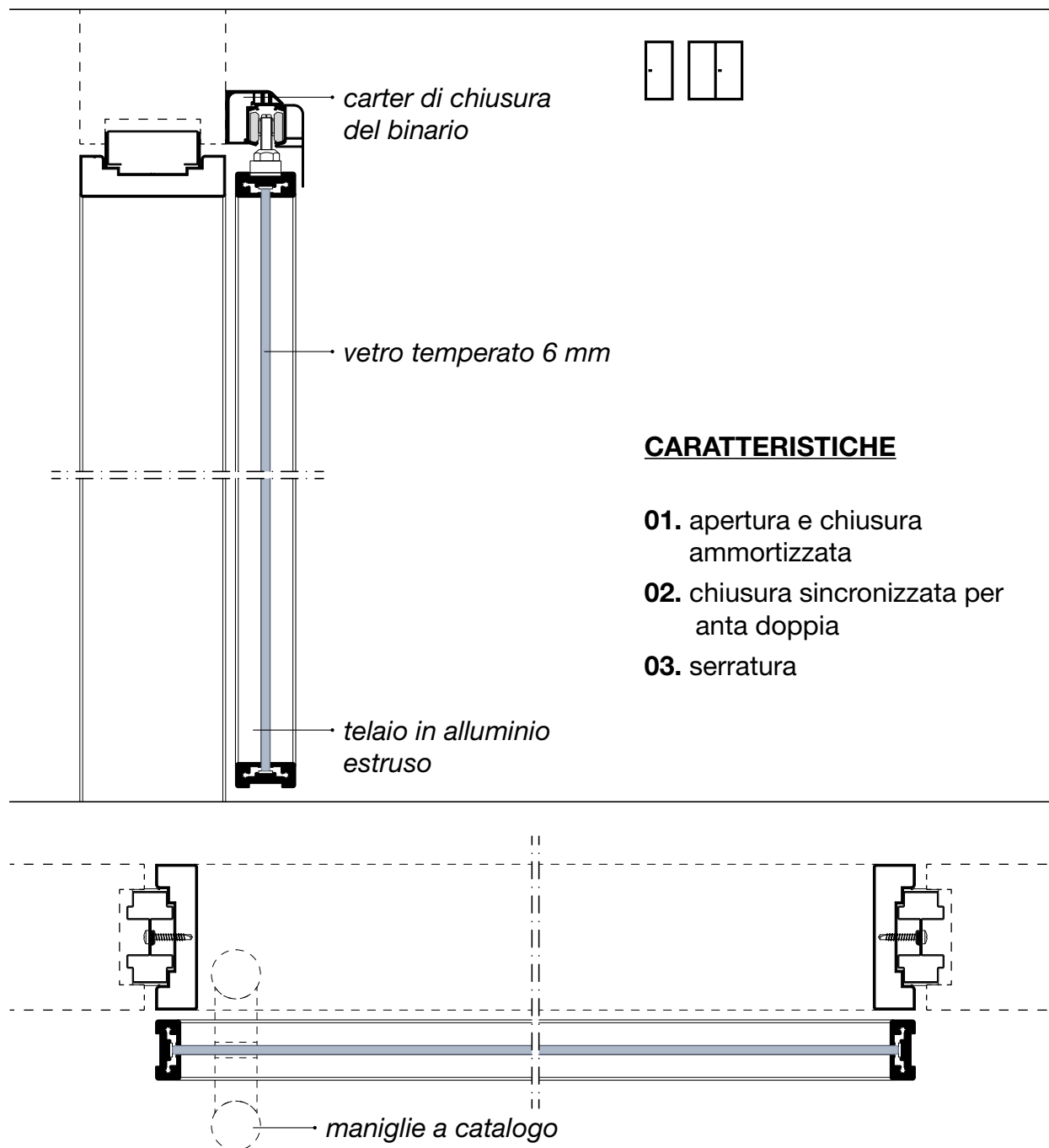

ANTA CIECA_SCORREVOLE INTERNA sp. 38 mm

*solo per Metrica Solid

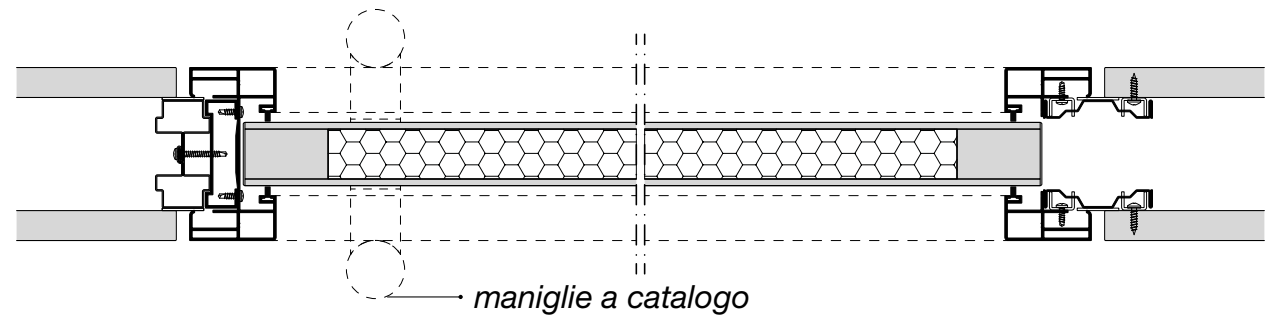
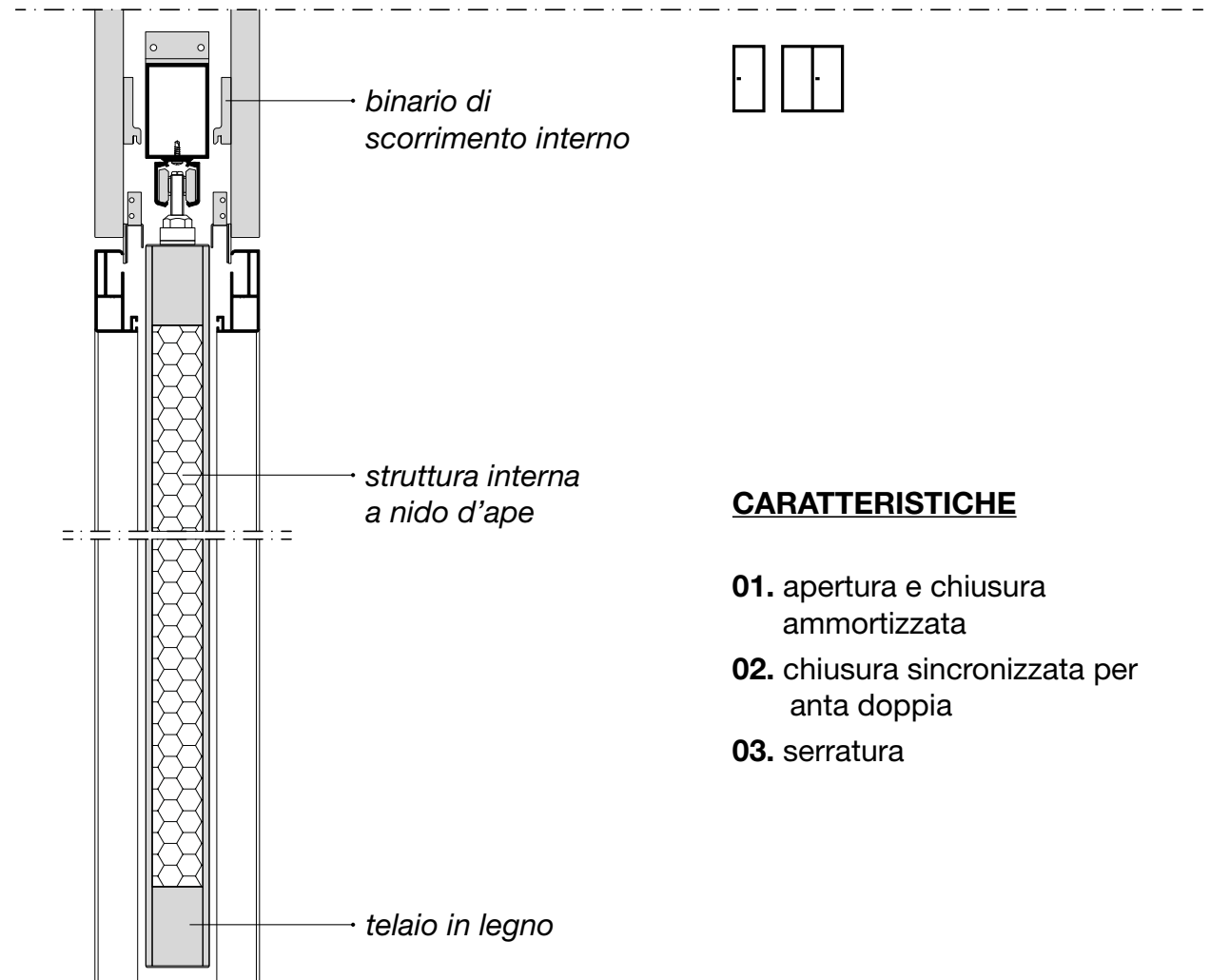

ANTA VETRO TEMPERATO_SCORREVOLE INTERNA sp. 10 mm

*solo per Metrica Solid

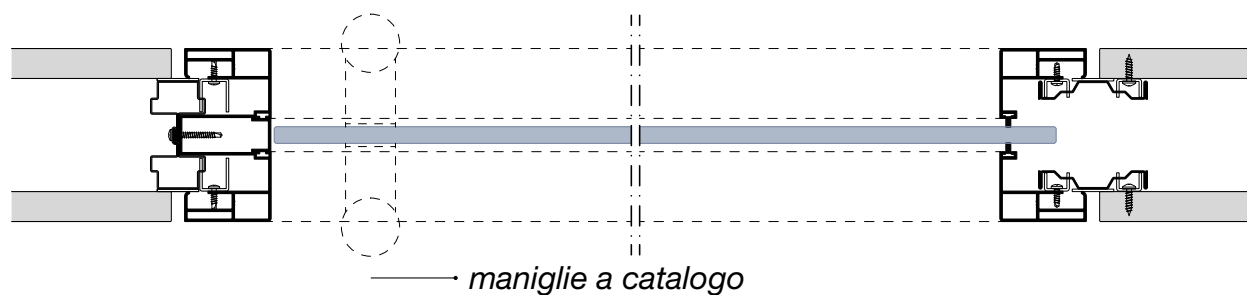
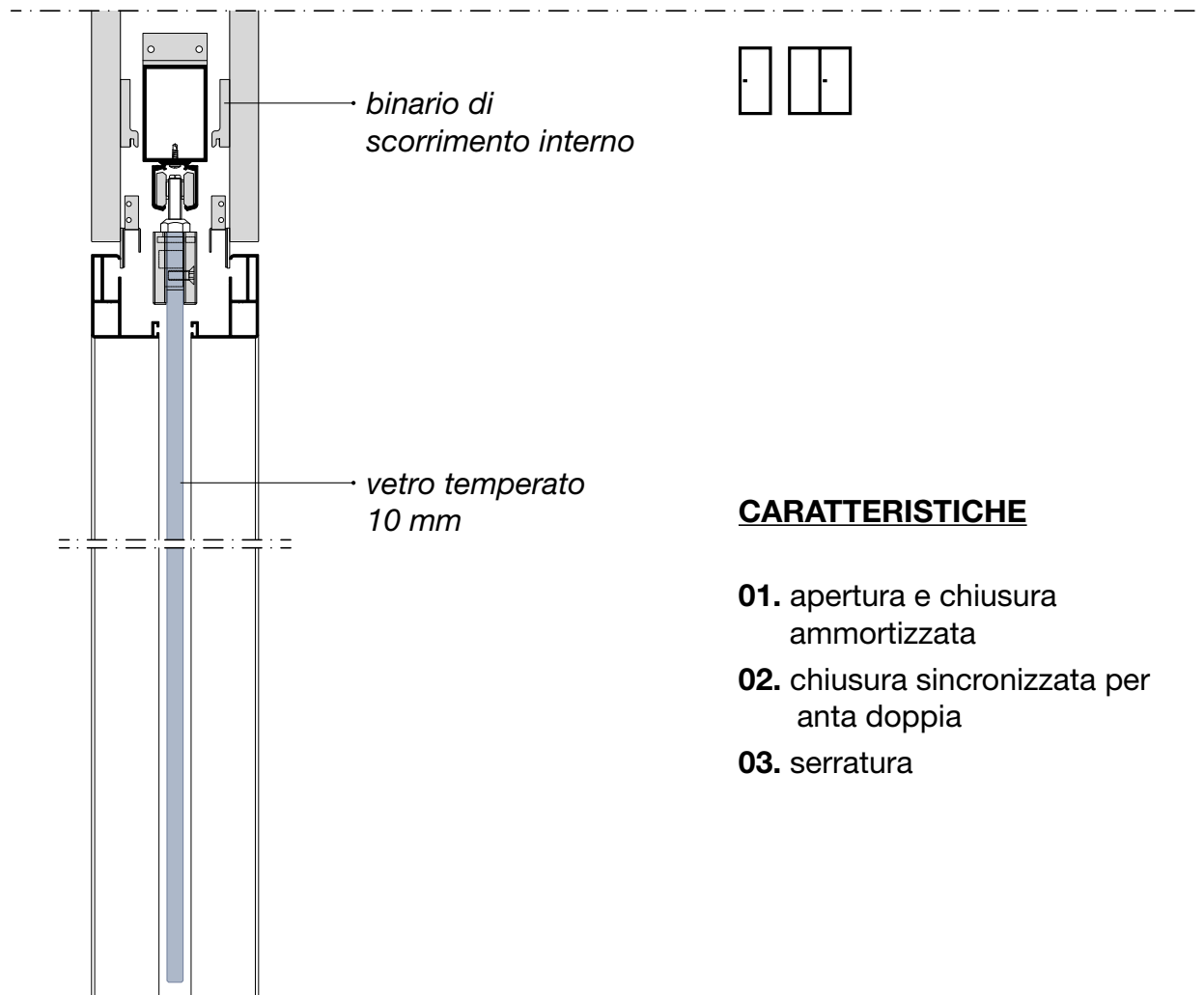
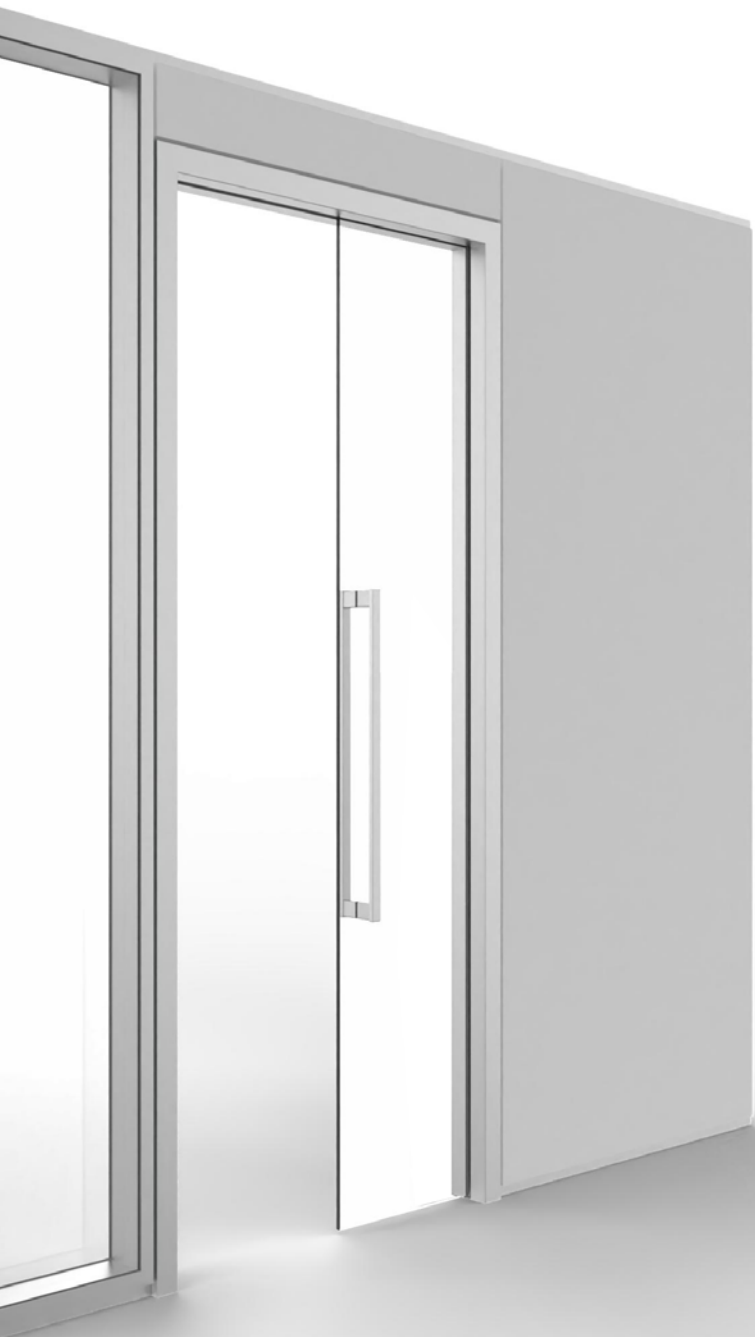

TELAI PORTE BATTENTI

Metrica F



Telaio porta **Metrica F** su **Metrica F1**

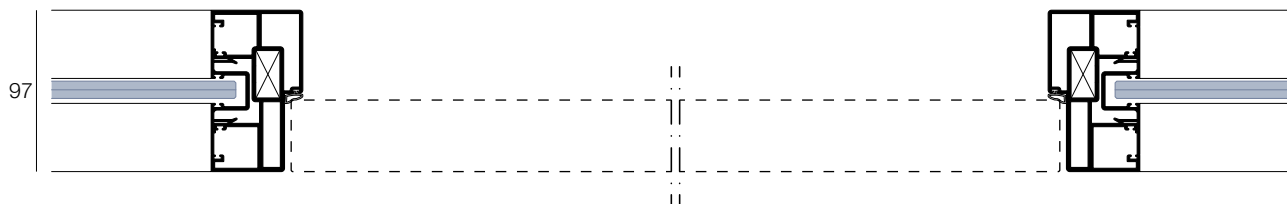

Telaio porta **Metrica F** su **Metrica FA**

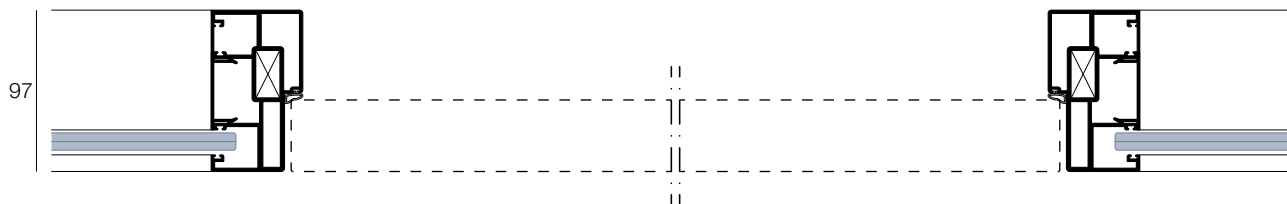

Telaio porta **Metrica F** su **Metrica F2**

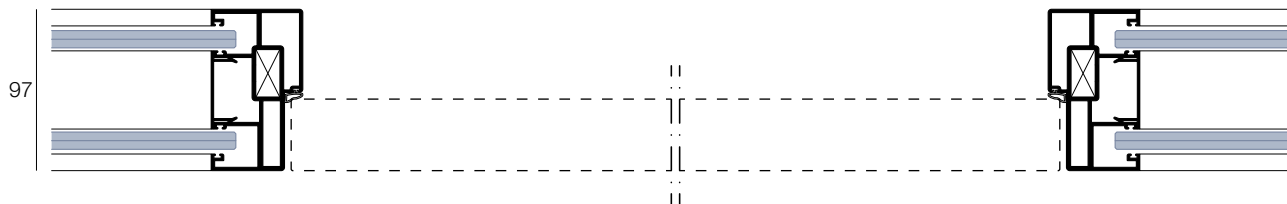

Telaio porta **Metrica F** su **Metrica F Solid**

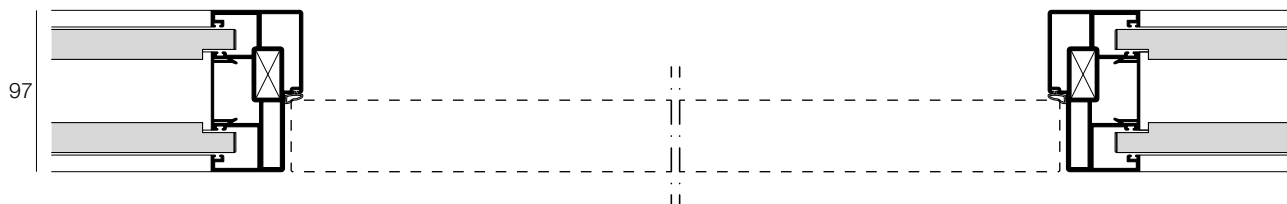

ANTA CIECA sp. 43 mm

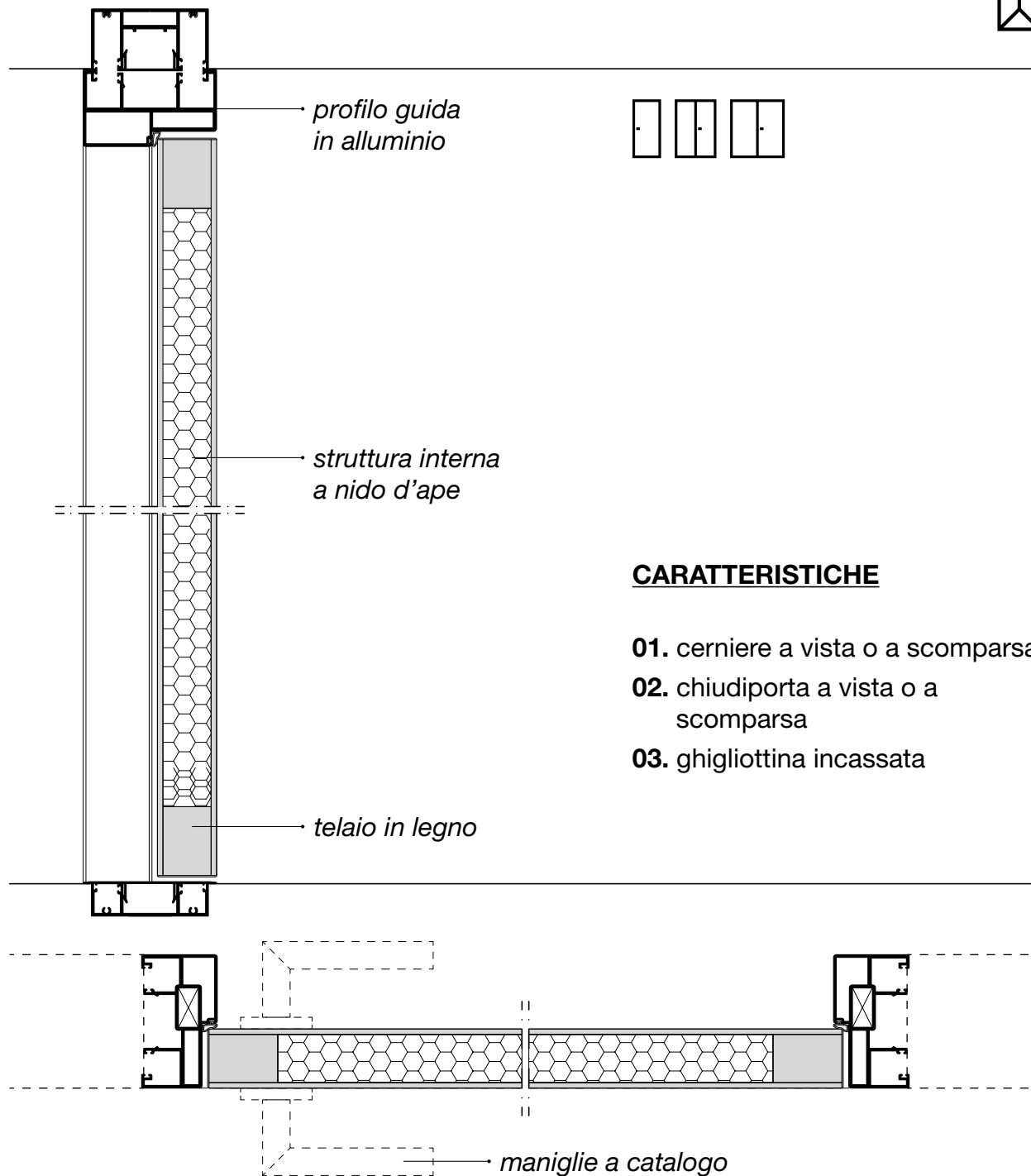

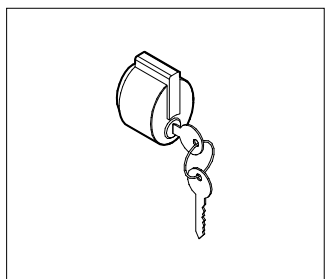

ML1

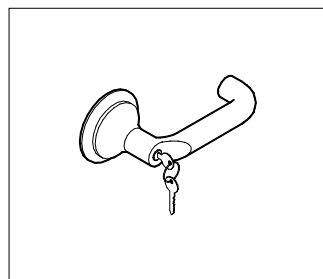

ML4

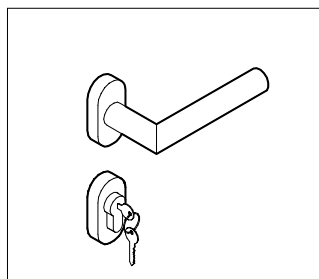

ML5

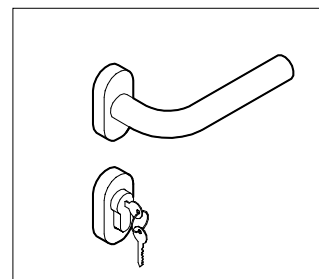

ML6

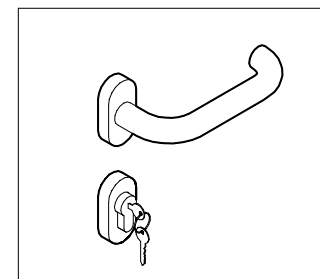

ML7

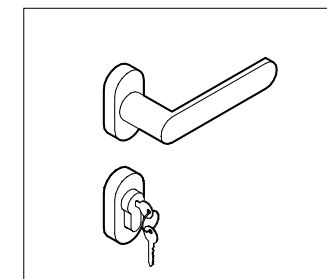

ML8

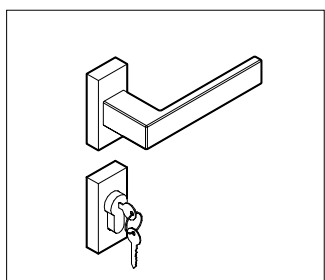

ML9

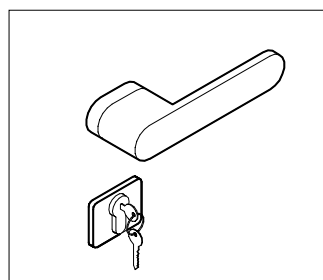

ML10

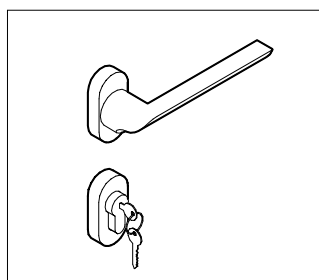

ML11

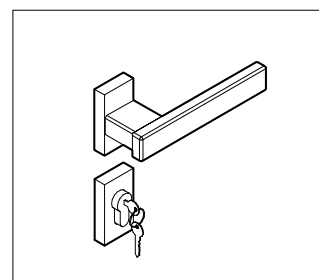

MLQ

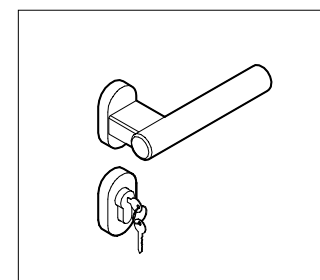

MLT

ANTA VETRO TEMPERATO sp. 10 mm

Cerniere a vista

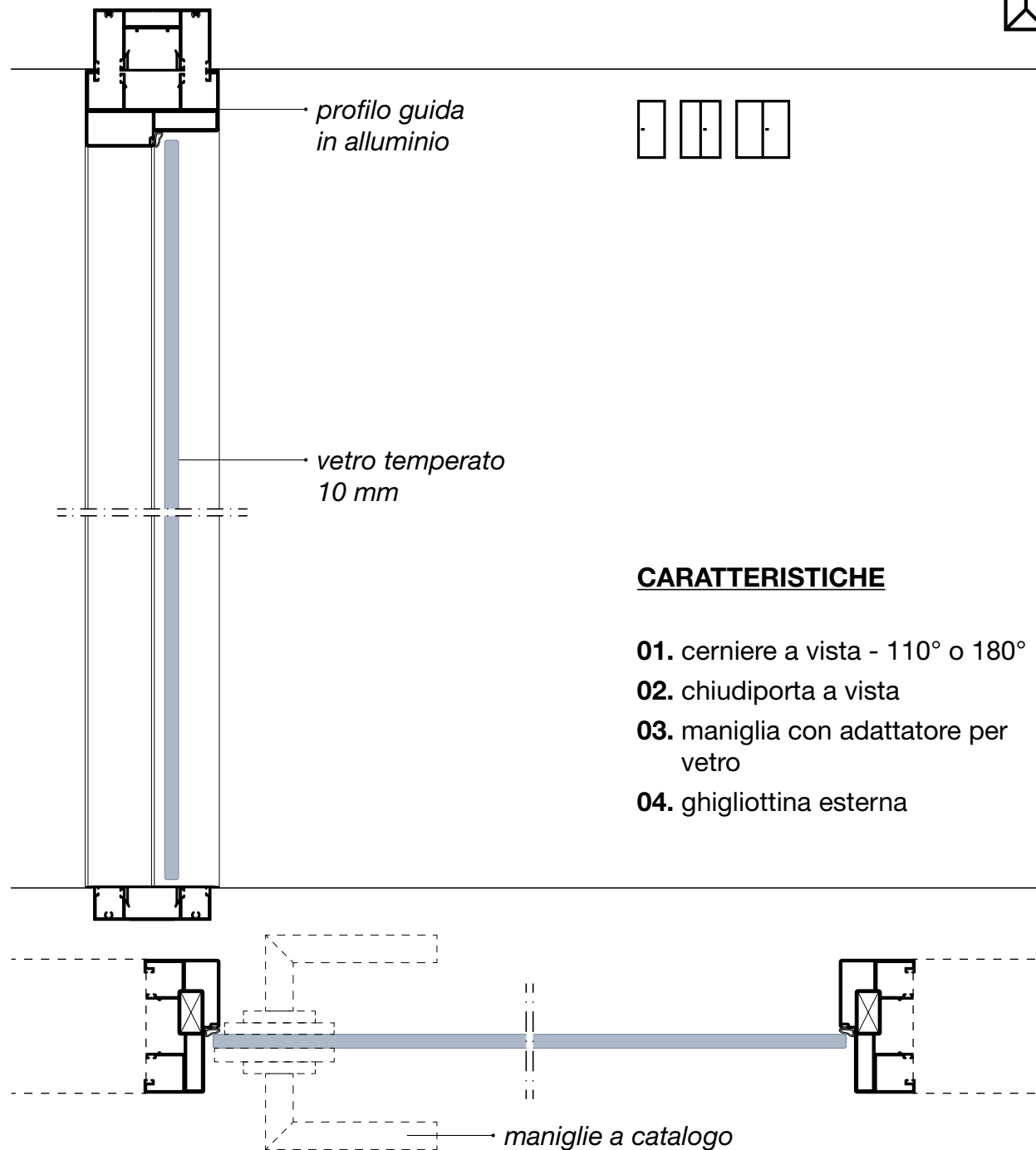

ANTA VETRO TEMPERATO sp. 10 mm

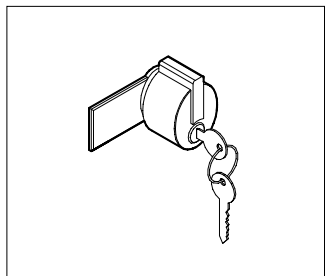

MC1

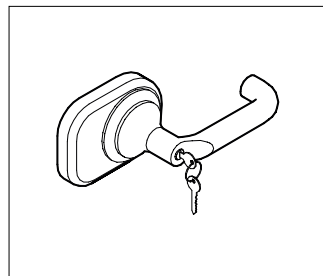

MC4

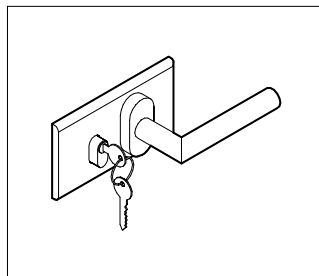

MC5

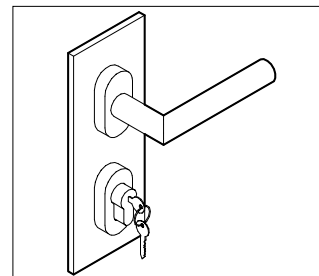

MC5V

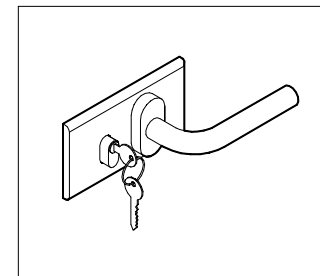

MC6

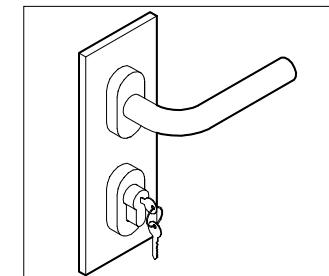

MC6V

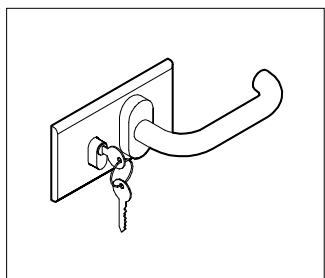

MC7

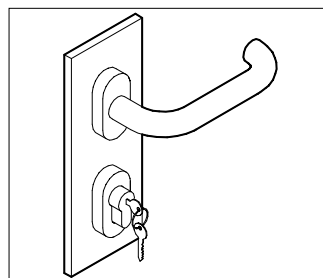

MC7V

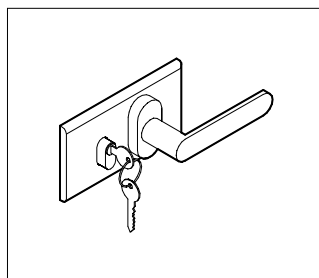

MC8

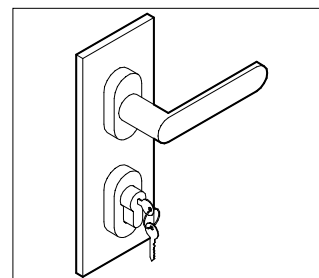

MC8V

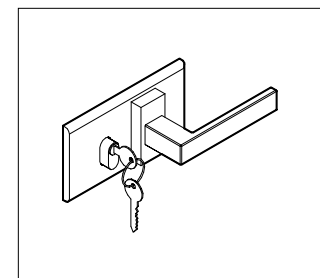

MC9

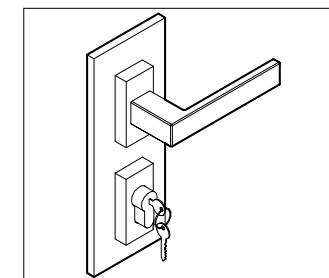

MC9V

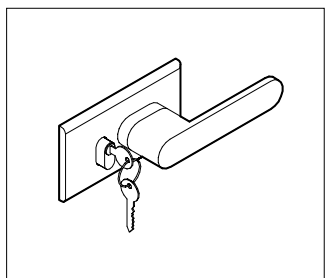

MC10

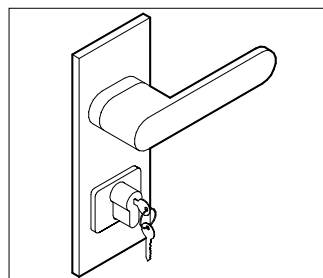

MC10V

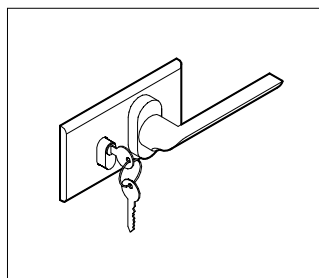

MC11

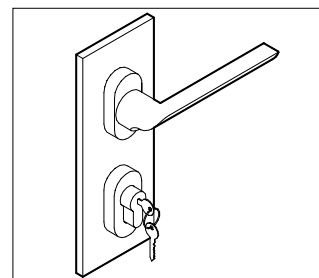

MC11V

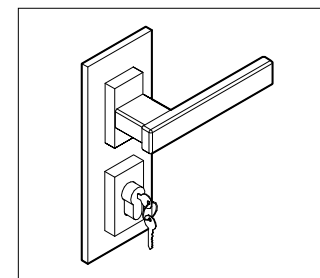

MCQ

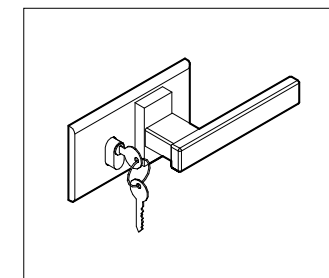

MCQO

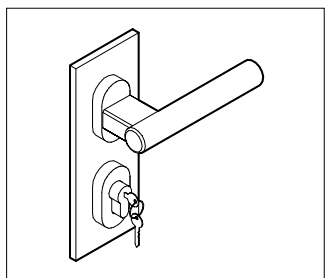

MCT

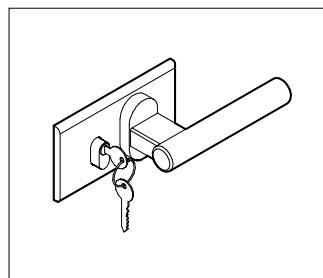

MCTO

ANTA VETRO TEMPERATO sp. 10 mm

Cerniera continua

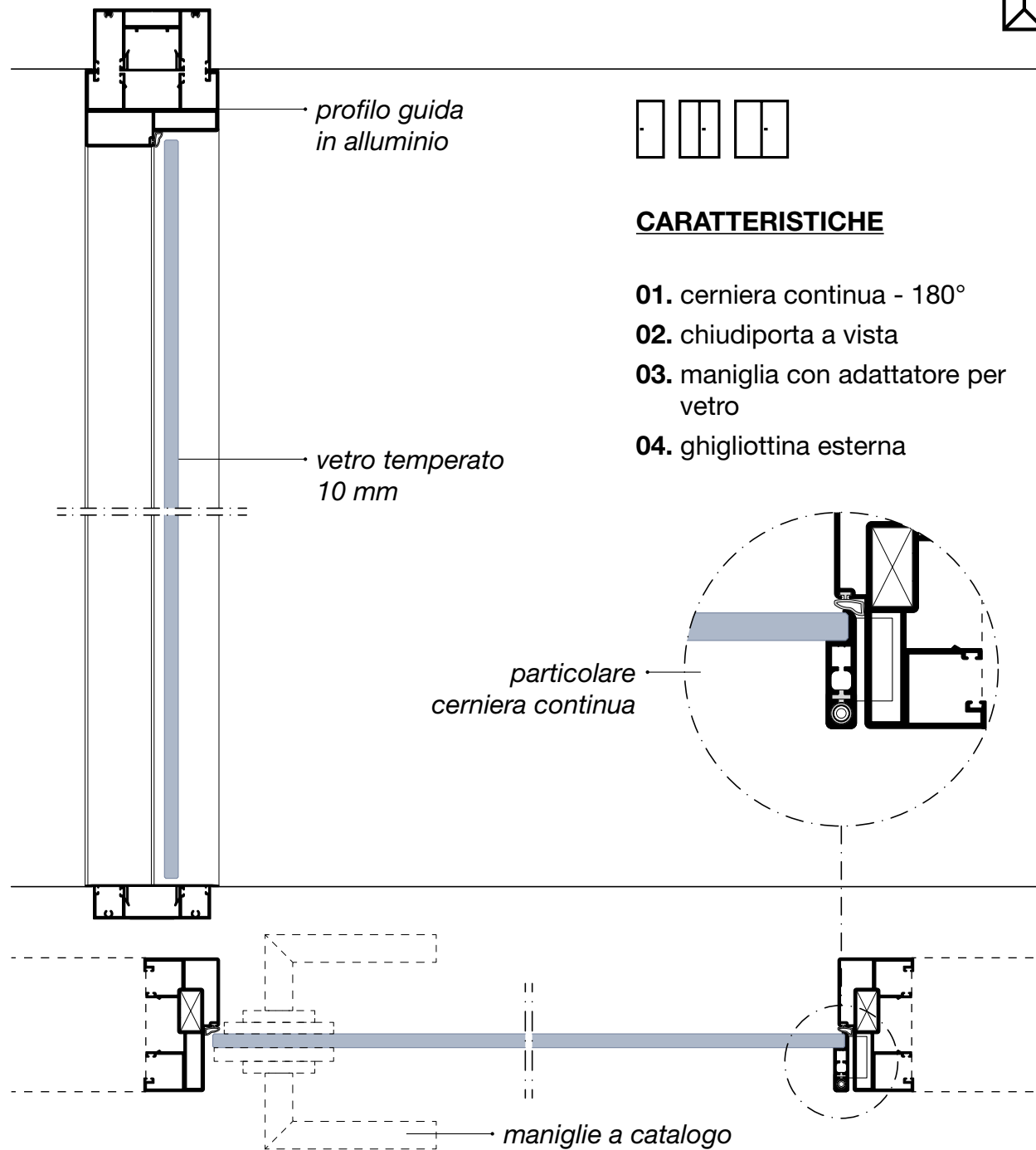
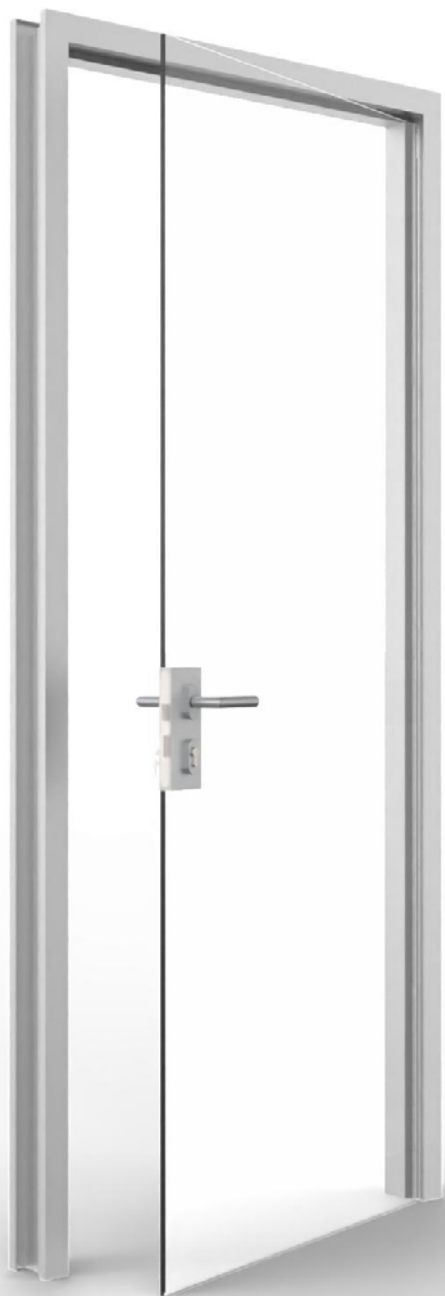

ANTA VETRO TEMPERATO sp. 10 mm

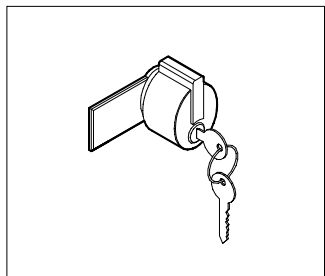

MC1

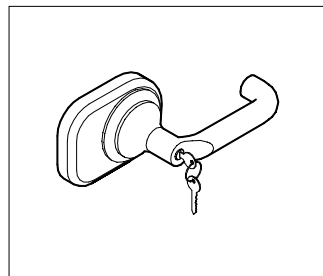

MC4

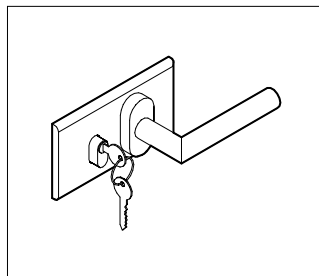

MC5

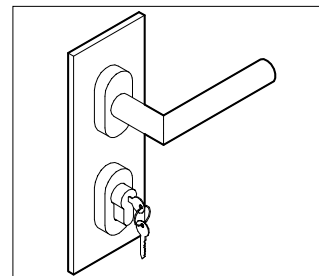

MC5V

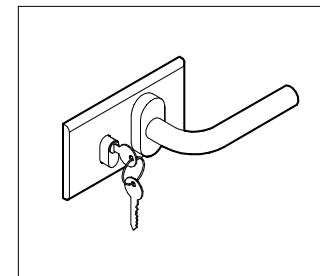

MC6

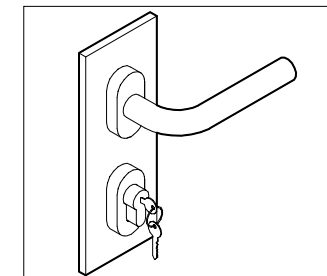

MC6V

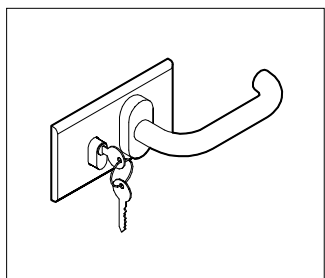

MC7

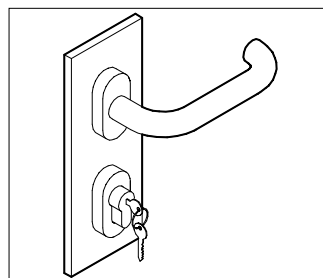

MC7V

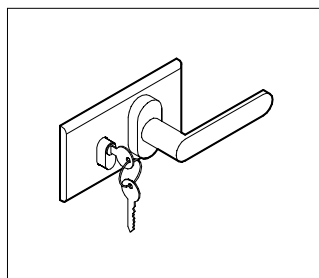

MC8

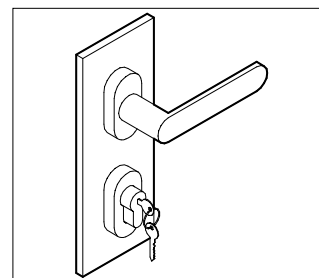

MC8V

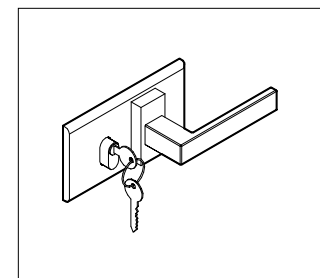

MC9

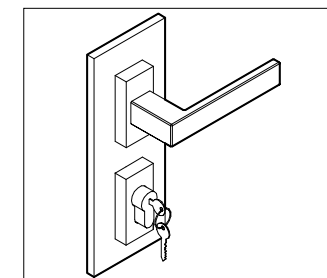

MC9V

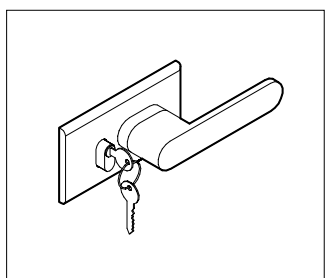

MC10

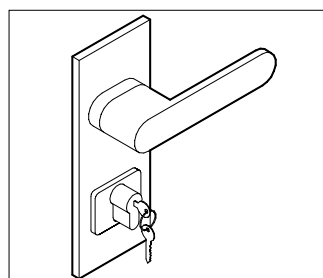

MC10V

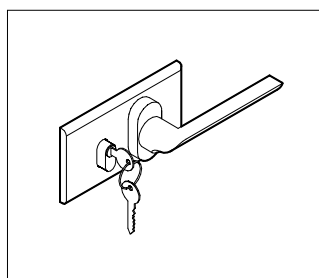

MC11

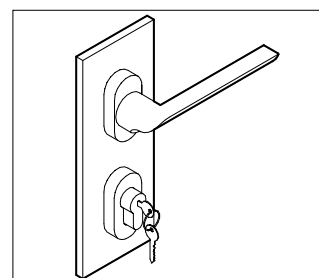

MC11V

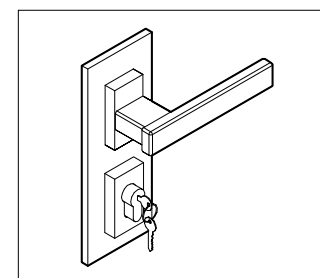

MCQ

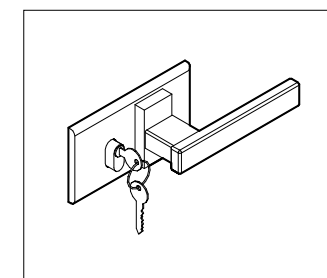

MCQO

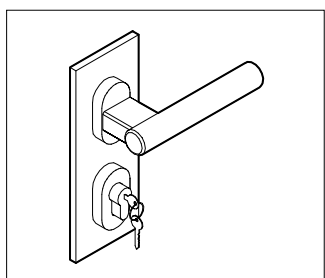

MCT

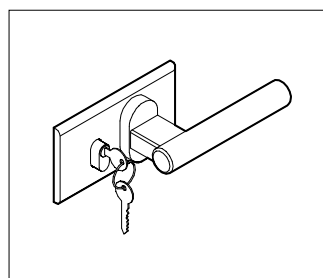

MCTO

ANTA INTELAIATA CIECA sp. 97 mm

Porta complanare

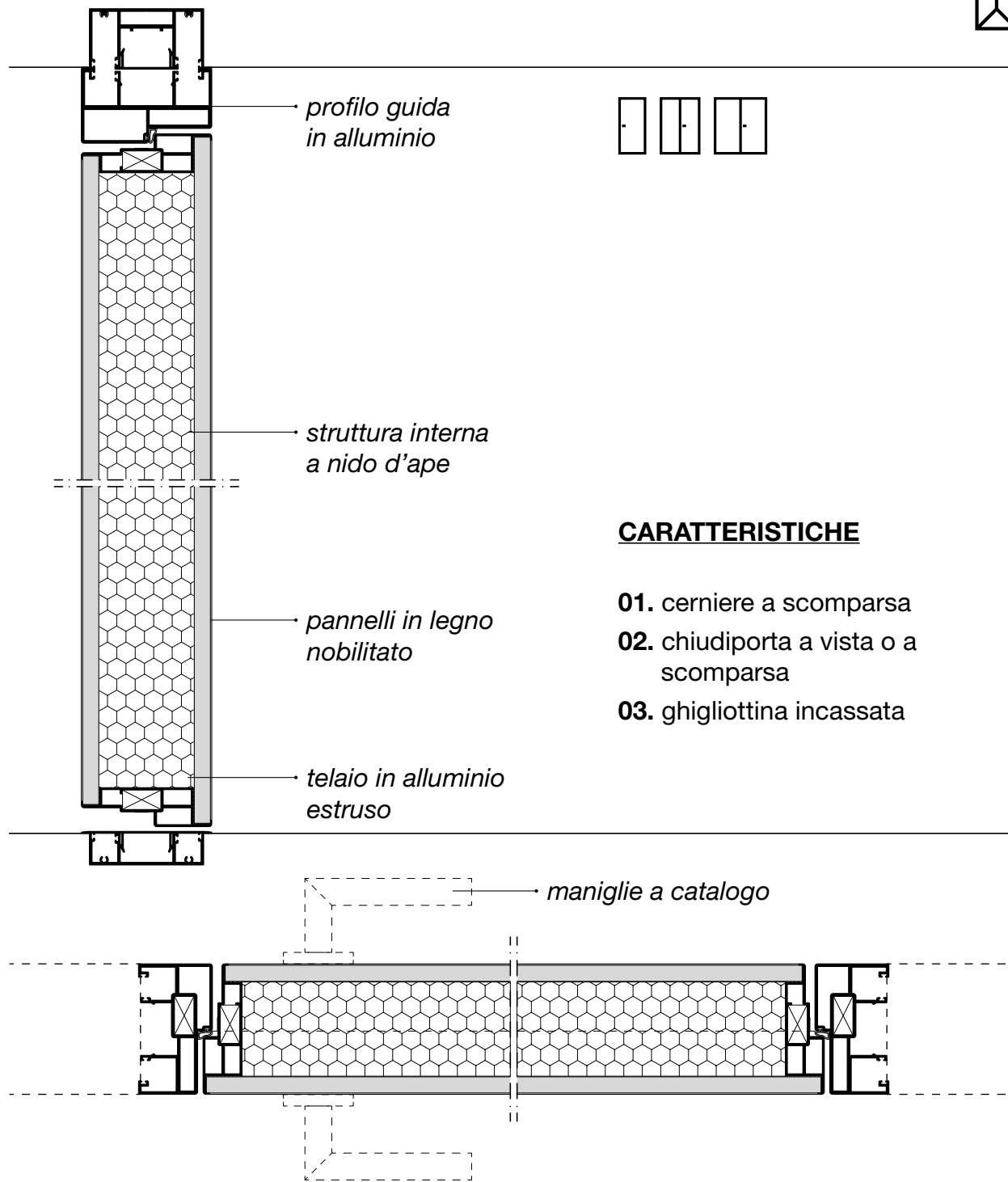

ANTA INTELAIATA CIECA sp. 97 mm

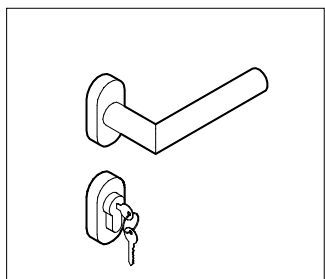

ML5

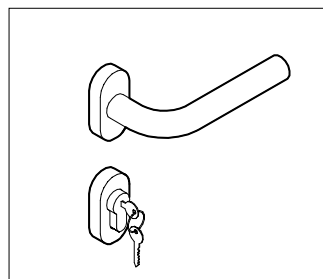

ML6

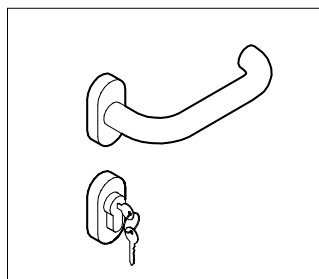

ML7

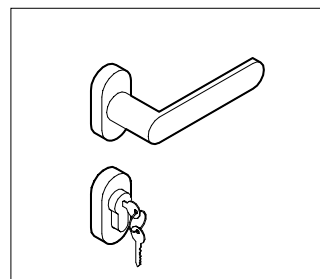

ML8

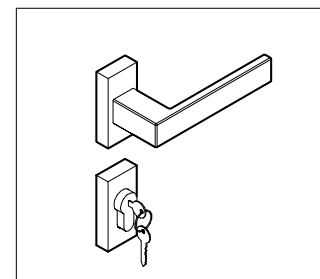

ML9

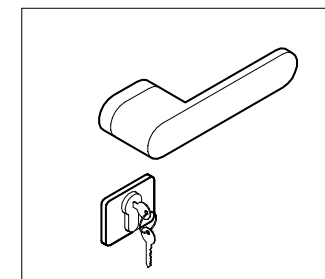

ML10

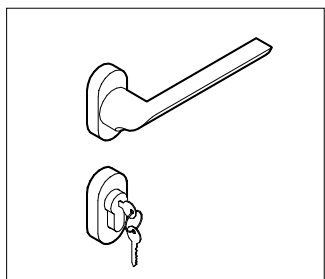

ML11

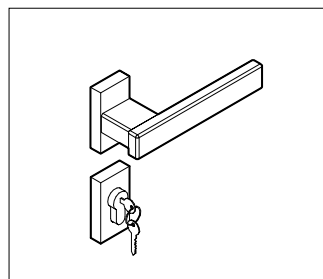

MLQ

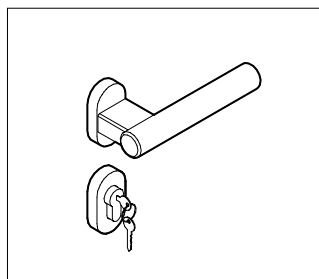

MLT

ANTA INTELAIATA VETRO DOPPIO sp. 97 mm

Porta complanare

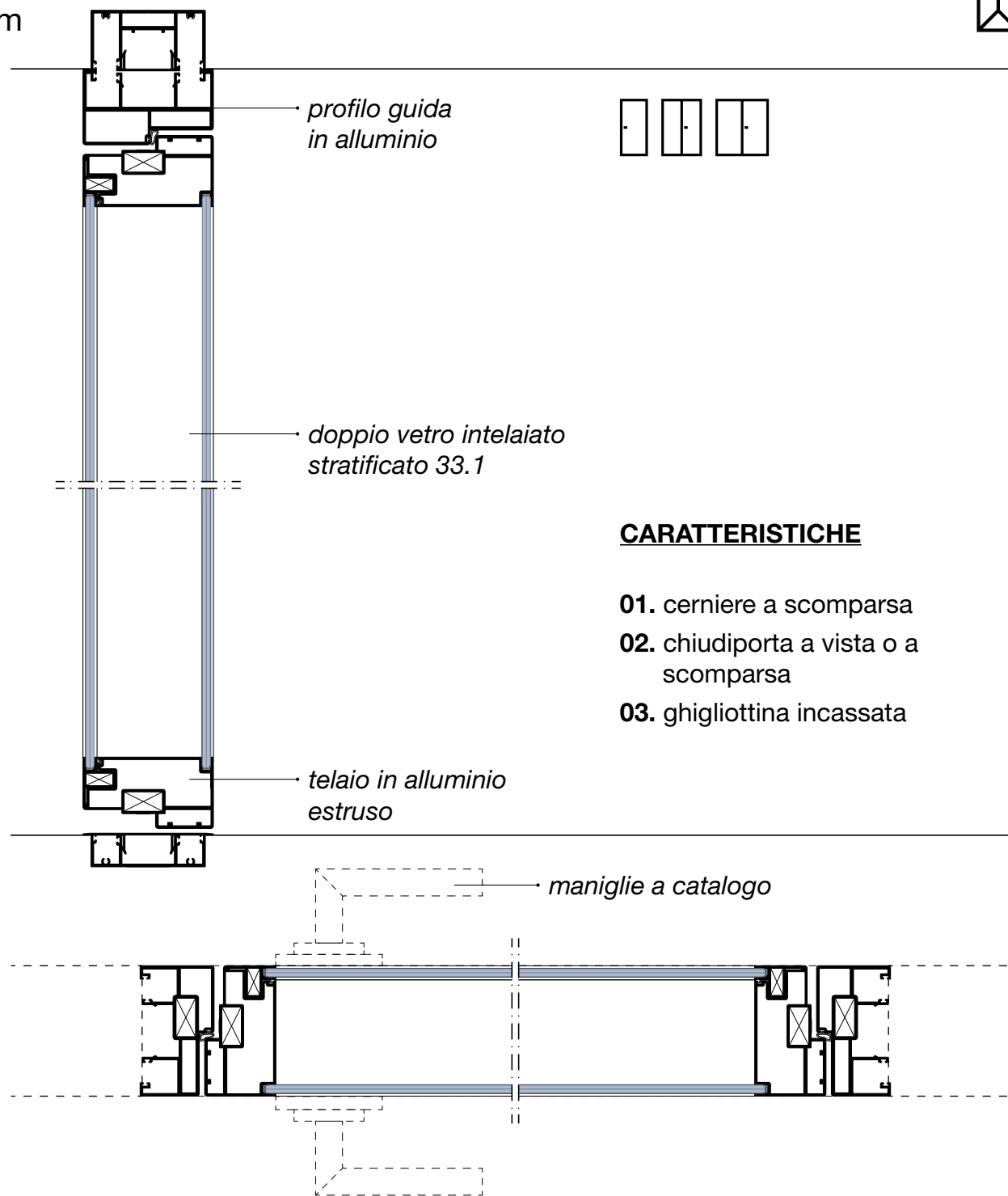

ANTA INTELAIATA VETRO DOPPIO sp. 97 mm

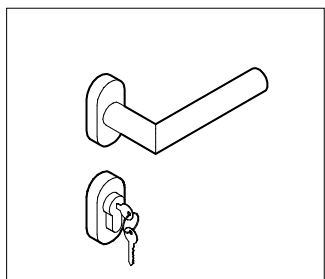

ML5

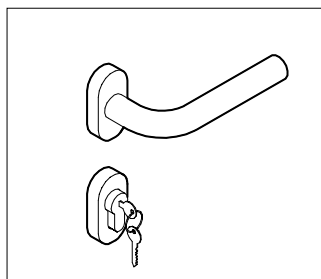

ML6

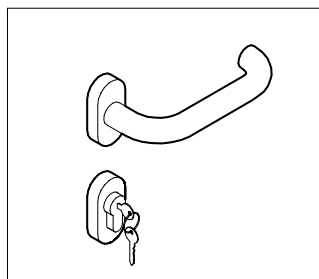

ML7

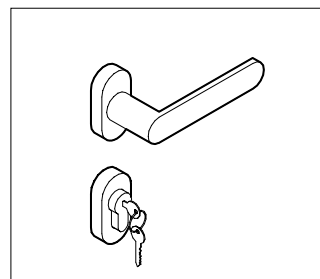

ML8

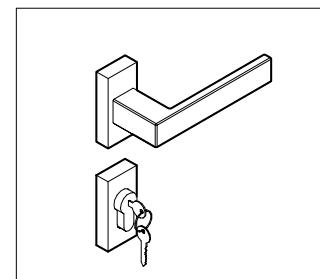

ML9

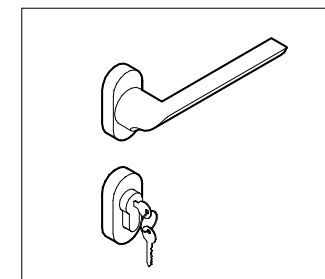

ML11

ANTA INTELAIATA sp. 25 mm

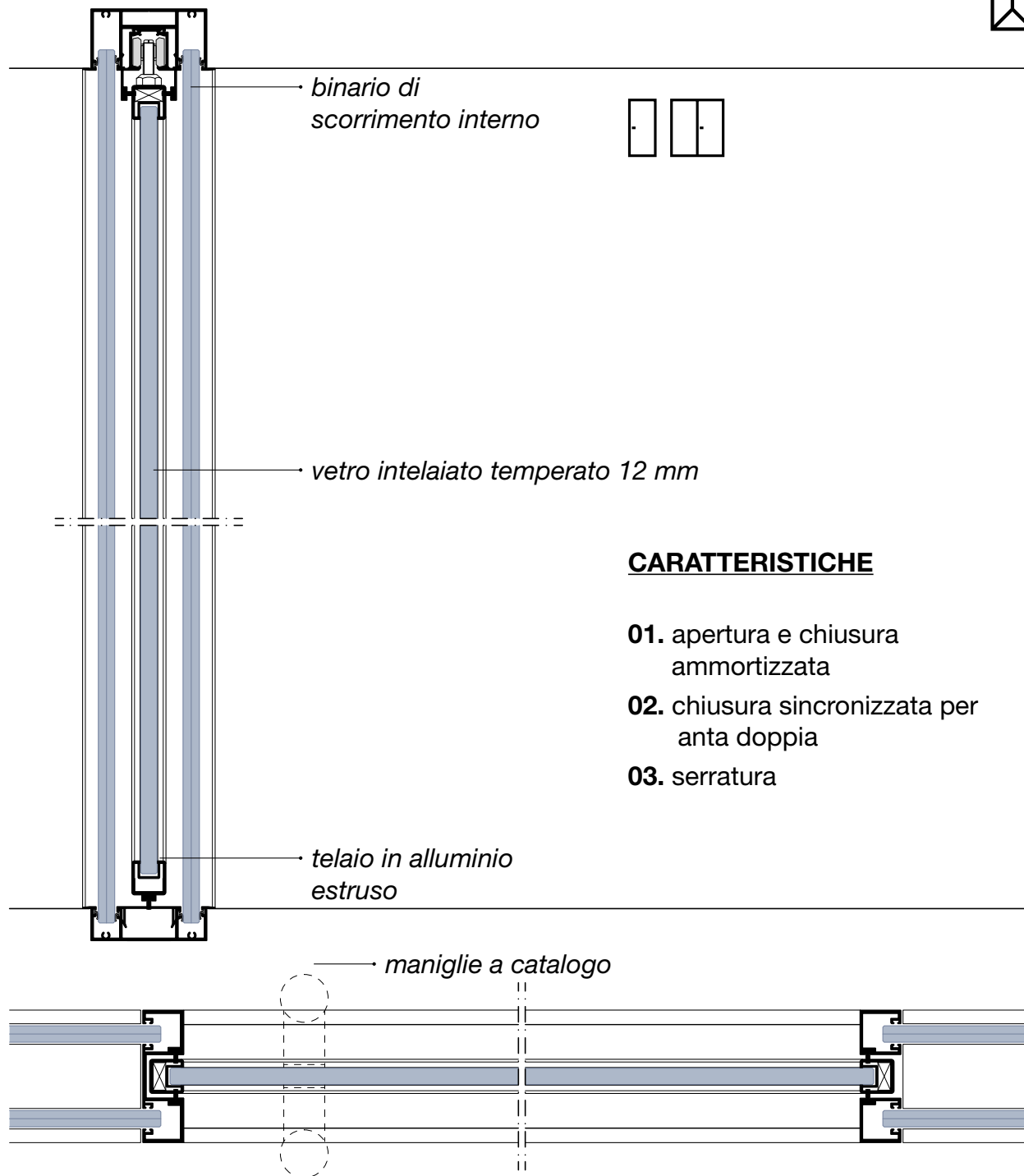

Porte in vetro



ACCIAIO

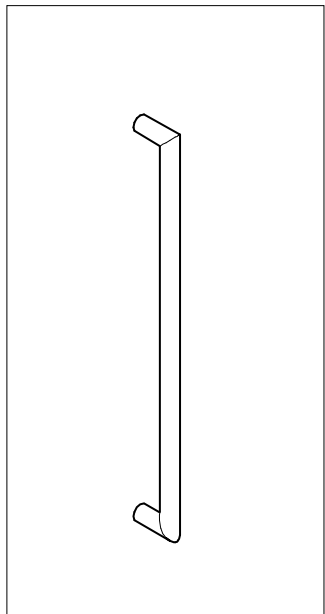

MPOMGH1_H2_H3

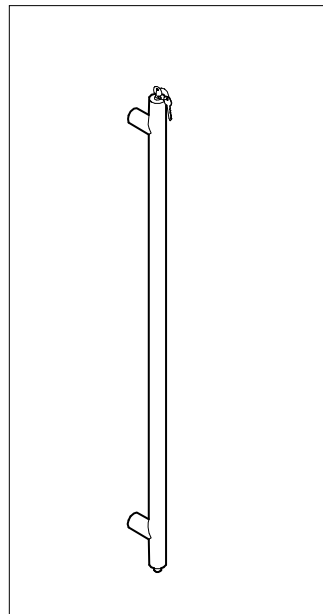

MPOM2

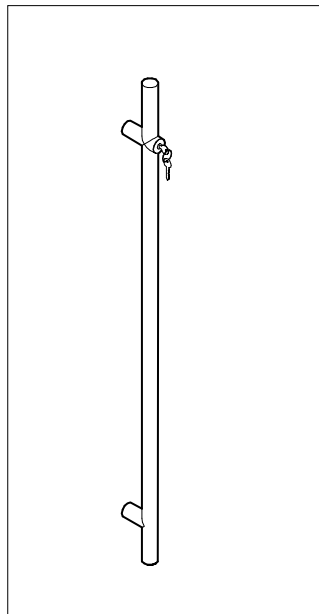

MPOM3

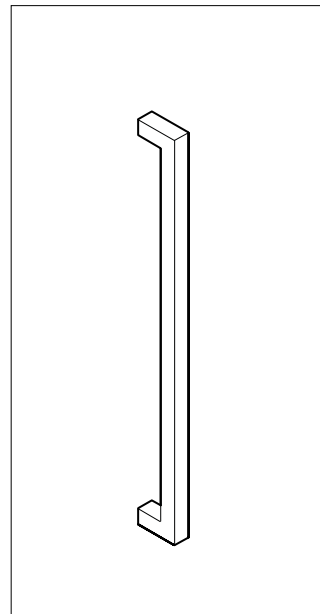

MPOMGH1Q_GH2Q_GH3Q

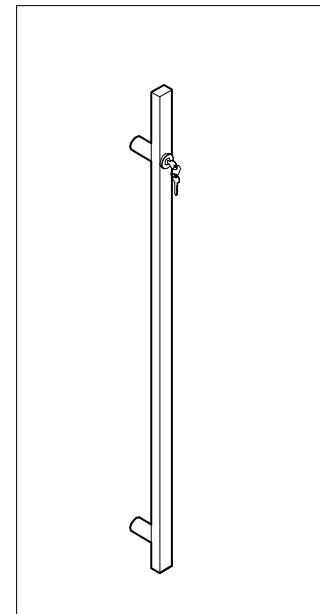

MPOM3Q

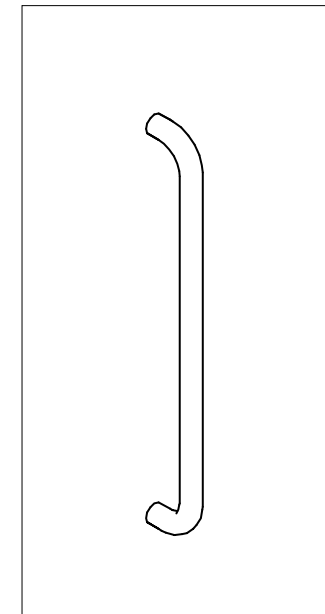

MPOM8

ALLUMINIO

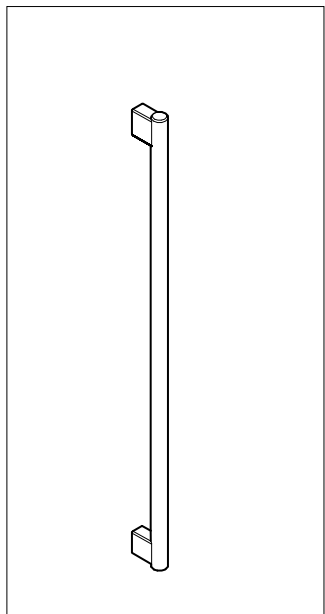

MPOMTH1_TH2

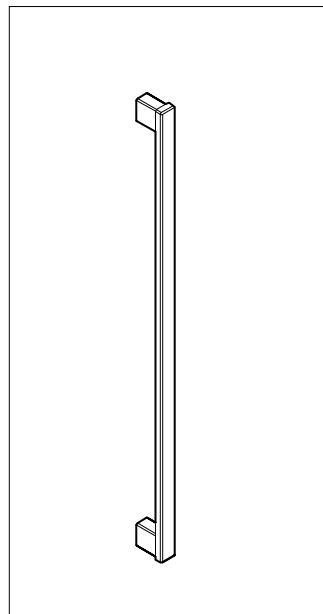

MPOMQH1_QH2

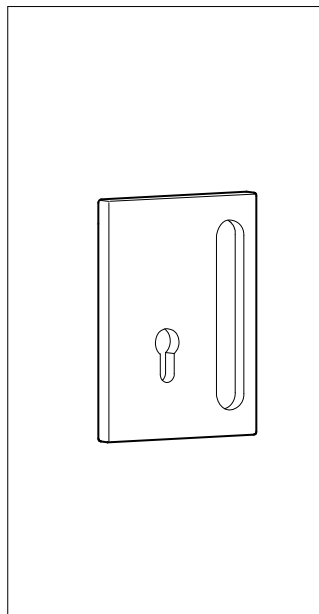

MPOM6

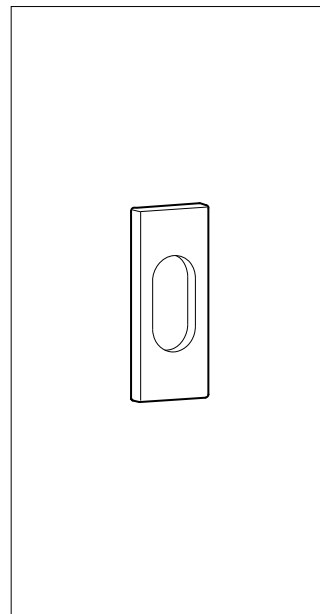

MPOM7

Porte cieche



ACCIAIO

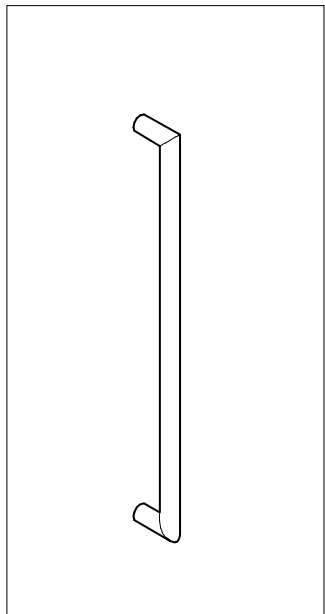

MPOMGH1_H2_H3

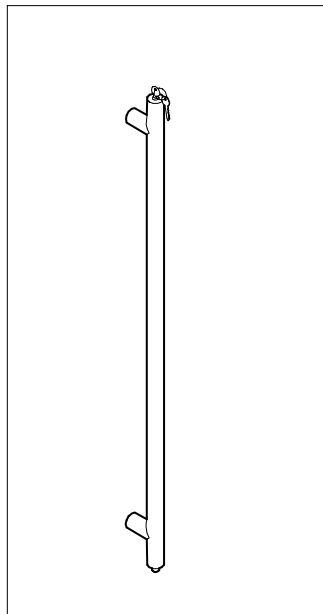

MPOM2

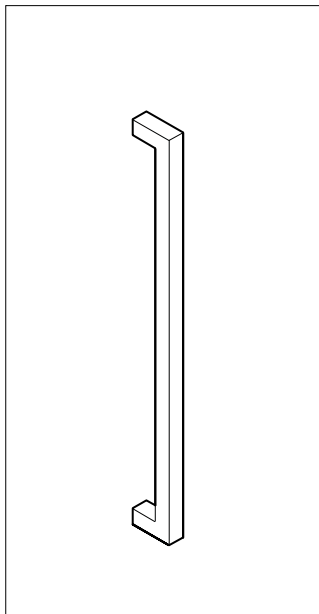

MPOMGH1Q_GH2Q_GH3Q

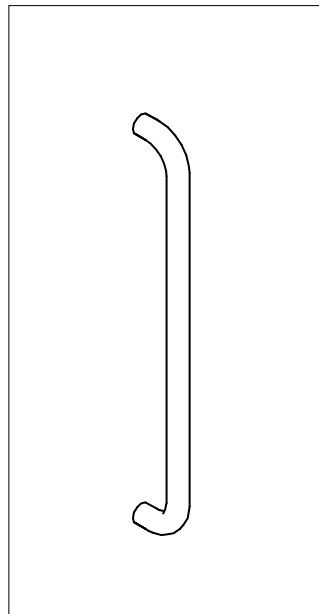

MPOM8

ALLUMINIO

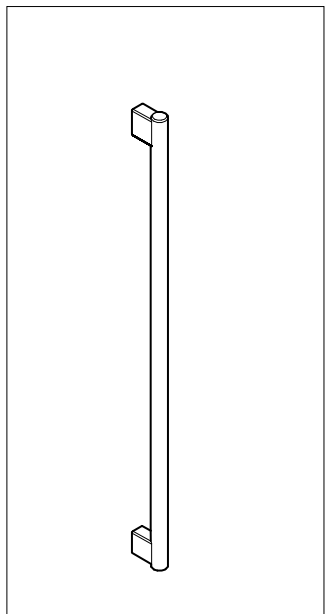

MPOMTH1_TH2

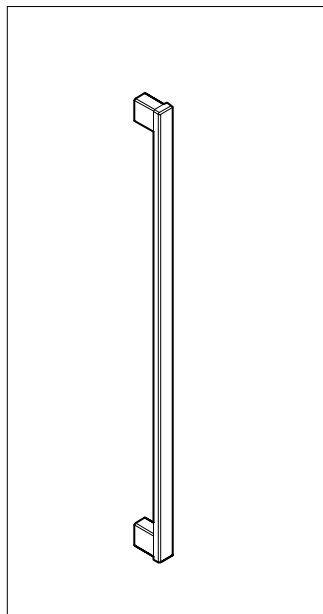

MPOMQH1_QH2

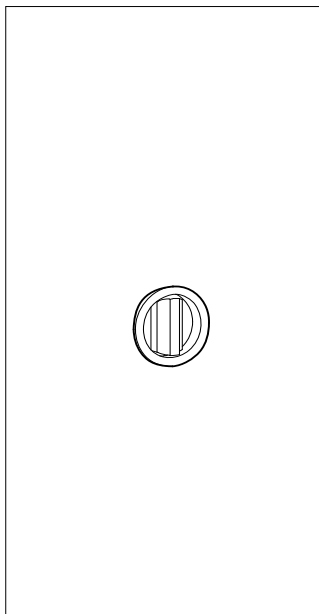

MPOM4

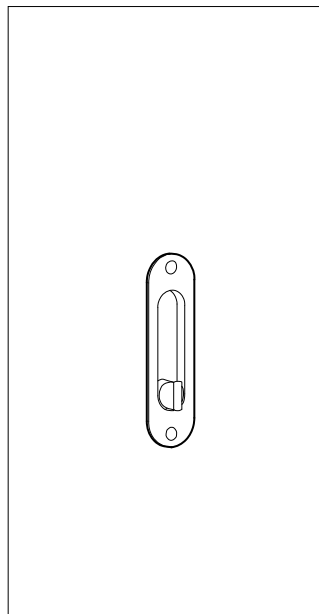

MPOM5

METRICA[®]
SENZA STRUTTURA

Accessori



Chiudiporta aerei

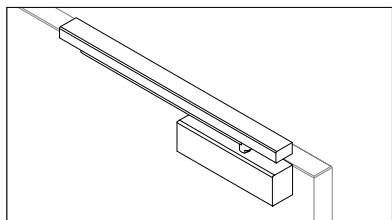

01 esterno a slitta
per anta cieca/intelaiata

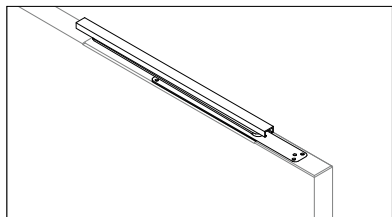

02 a scomparsa
per anta cieca/intelaiata

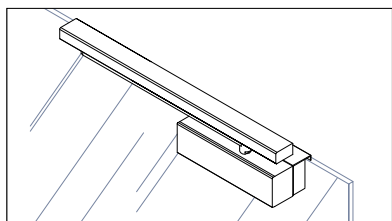

03 esterno a slitta con supporto
per anta in vetro temperato

Chiudiporta a terra

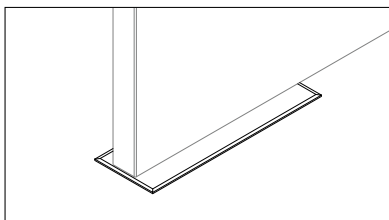

01 a pavimento
per anta cieca

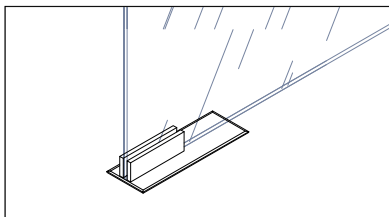

02 a pavimento
per anta in vetro temperato

Cerniere in alluminio

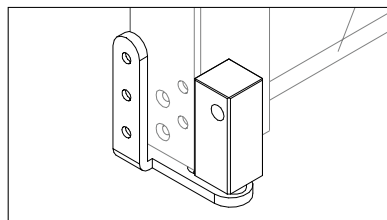

01 a bilico esterno
per anta cieca/intelaiata

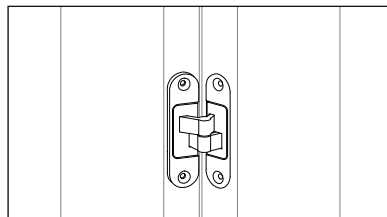

02 a scomparsa
per anta cieca/intelaiata

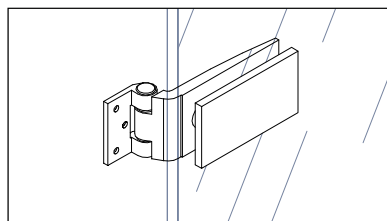

03 apertura 180°
per anta in vetro temperato

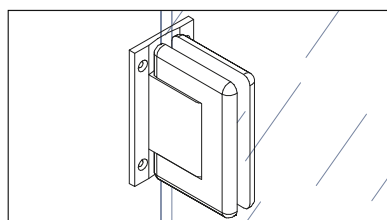

04 va e vieni velocità regolabile
per anta in vetro temperato

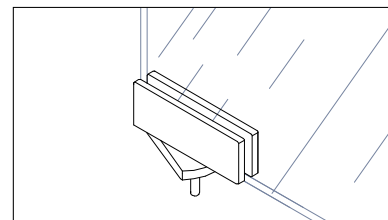

05 va e vieni velocità regolabile
per anta in vetro temperato

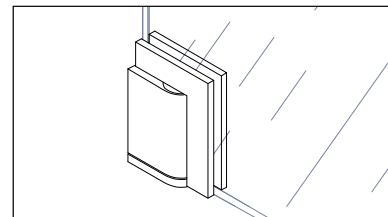

06 va e vieni velocità regolabile
per anta in vetro temperato

Accessori

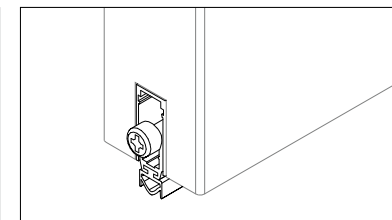

01 antispiffero insonorizzante
per anta cieca/intelaiata

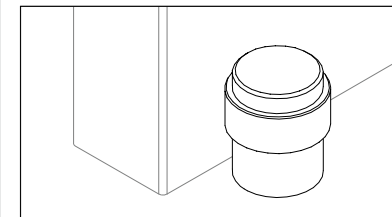

02 fermaporte
per anta cieca/intelaiata/temperato

METRICA[®]
SENZA STRUTTURA

Finiture



Anodizzati

Finiture RAL

Lucidatura

Legni



01 Alluminio naturale



01 Bianco



01 Brillantato



01 Rovere chiaro



02 Bronzo

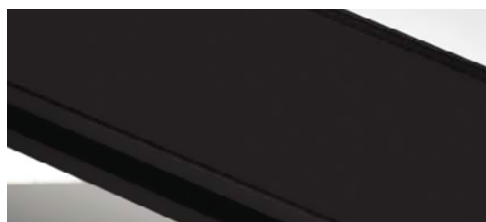

02 Nero

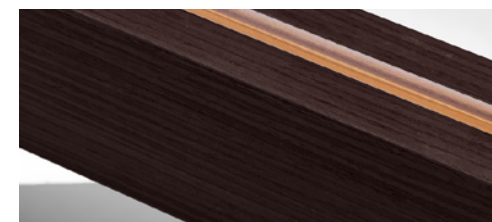

02 Rovere scuro

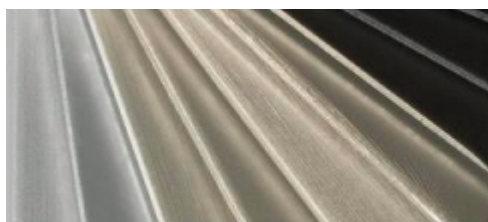

03 Colore a campione



03 Colore a campione

Pannelli ciechi



CAT. 1

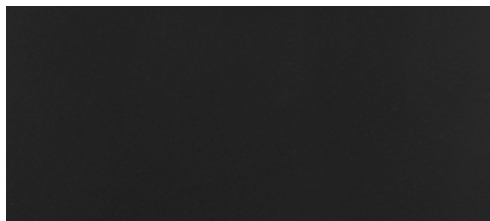

055 Nero grafite

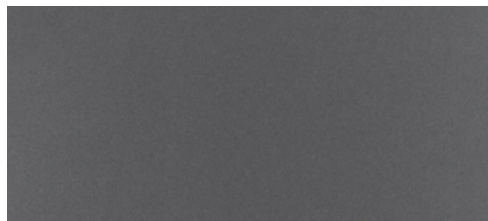

420 Piombo



418 Grigio cenere

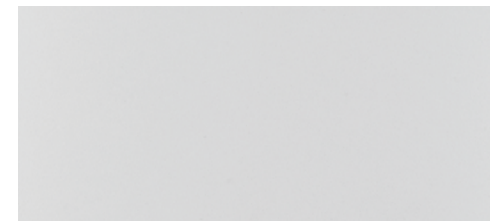

419 Grigio chiaro

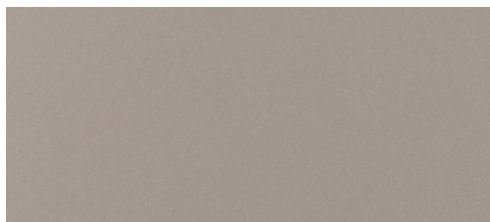

393 Tortora

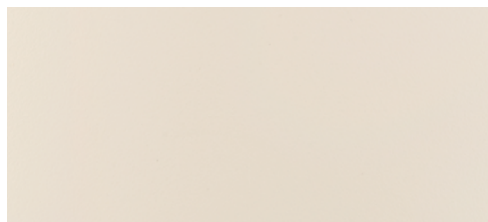

417 Vaniglia

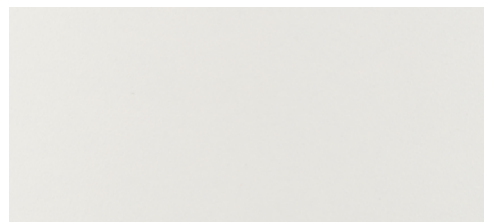

429 Bianco caldo

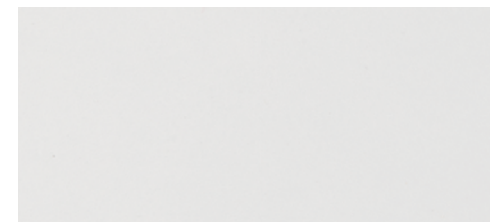

428 Bianco freddo

CAT. 2



422 Argento

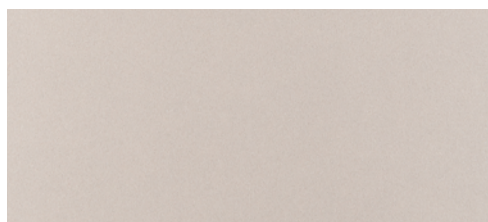

423 Champagne

Legni



CAT. 1

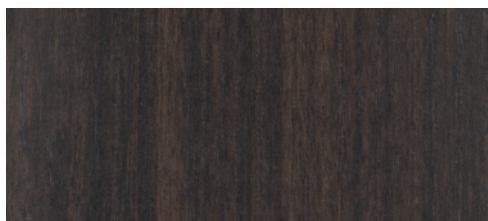

421 Eucalipto

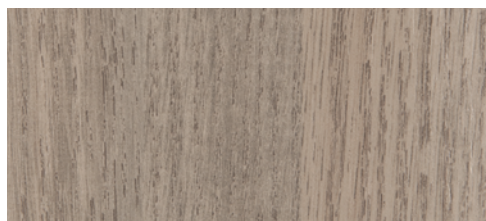

426 Rovere medio



274 Acacia



416 Bianco venato

CAT. 2

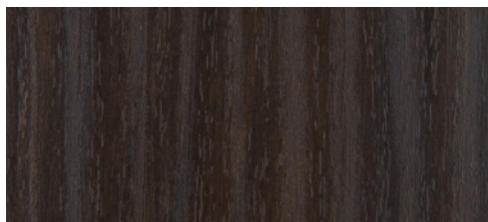

425 Noce scuro

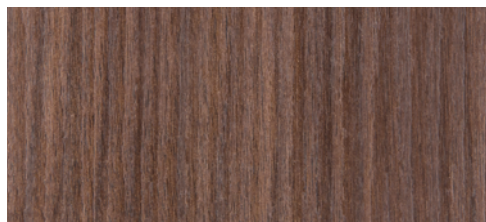

318 Noce medio

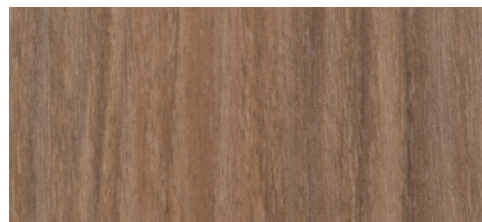

427 Noce chiaro

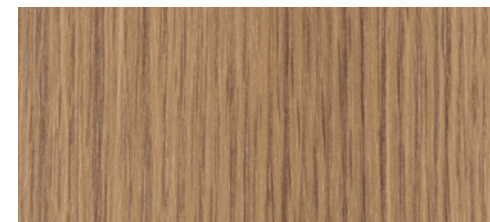

382 Rovere naturale

CAT. 3



138 Rovere invecchiato - taglio seta

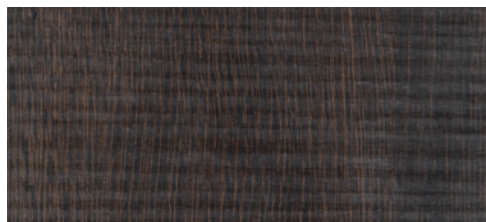

197 Eucalipto - taglio seta

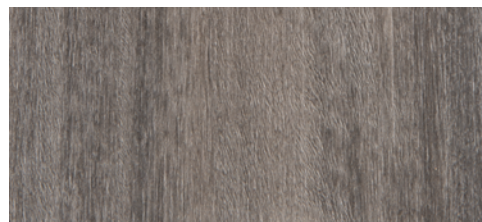

408 Rovere grigio

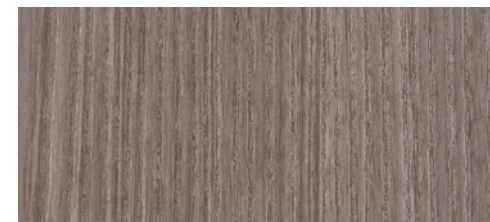

400 Rovere Danubio

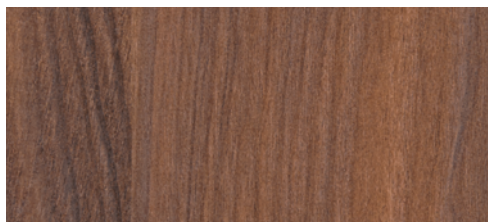

414 Noce rosso

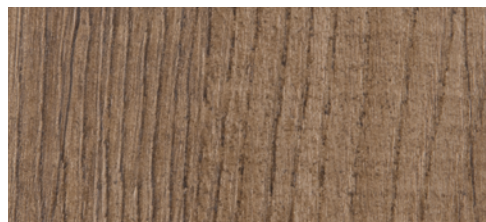

412 Rovere vintage

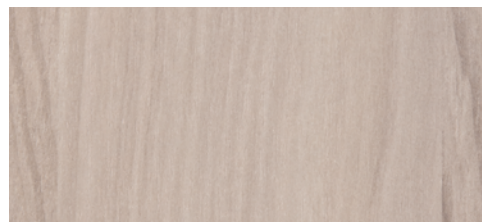

413 Rovere champagne



410 Rovere chiaro

Materici



CAT. 2

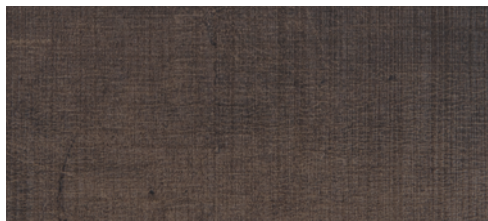

304 Tessuto scuro



123 Tessuto medio

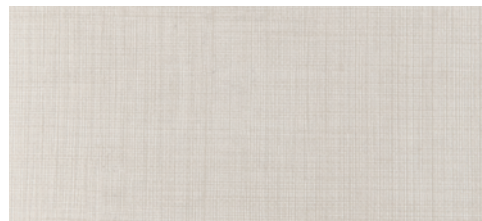

305 Tessuto chiaro



424 Ossido

CAT. 3

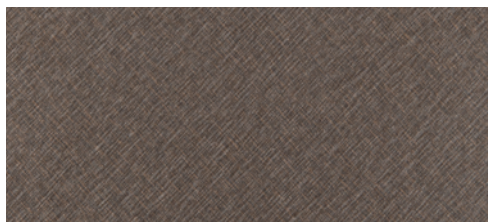

385 Lino bronzo

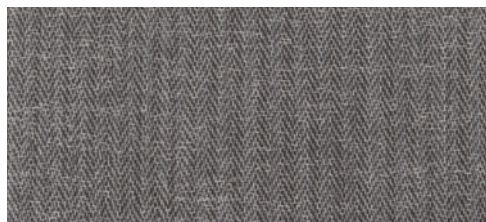

409 Corteccia

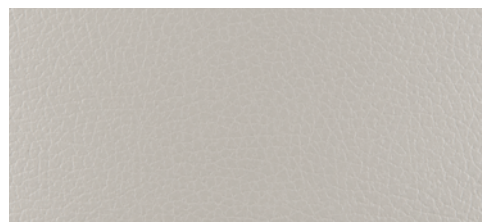

406 Primo fiore grigio

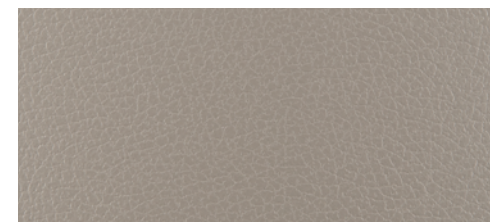

405 Primo fiore tortora



404 Primo fiore beige

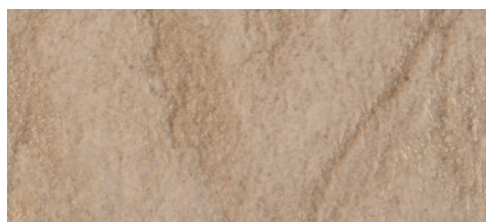

415 Deserto

Vetri



01 Trasparente



03 Satinato

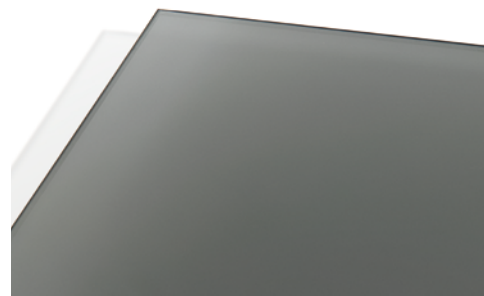

05 Fumé



02 Extrachiaro

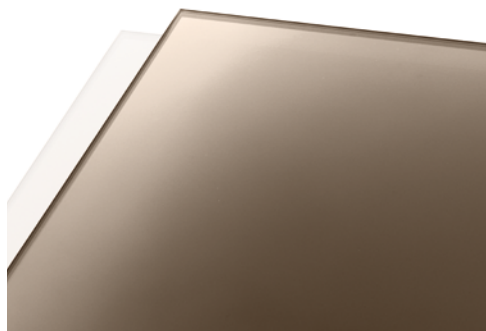

04 Bronzo



06 Verniciato a campione



Etoile s.r.l. - Società Unipersonale

Via D. Albertario, 50 61032 Zona Ind.le Bellocchi - Fano (PU) Italy
P. +39.0721.85.59.34 - F. +39.0721.85.92.14
info@etoilesrl.it - www.etoilesrl.it