

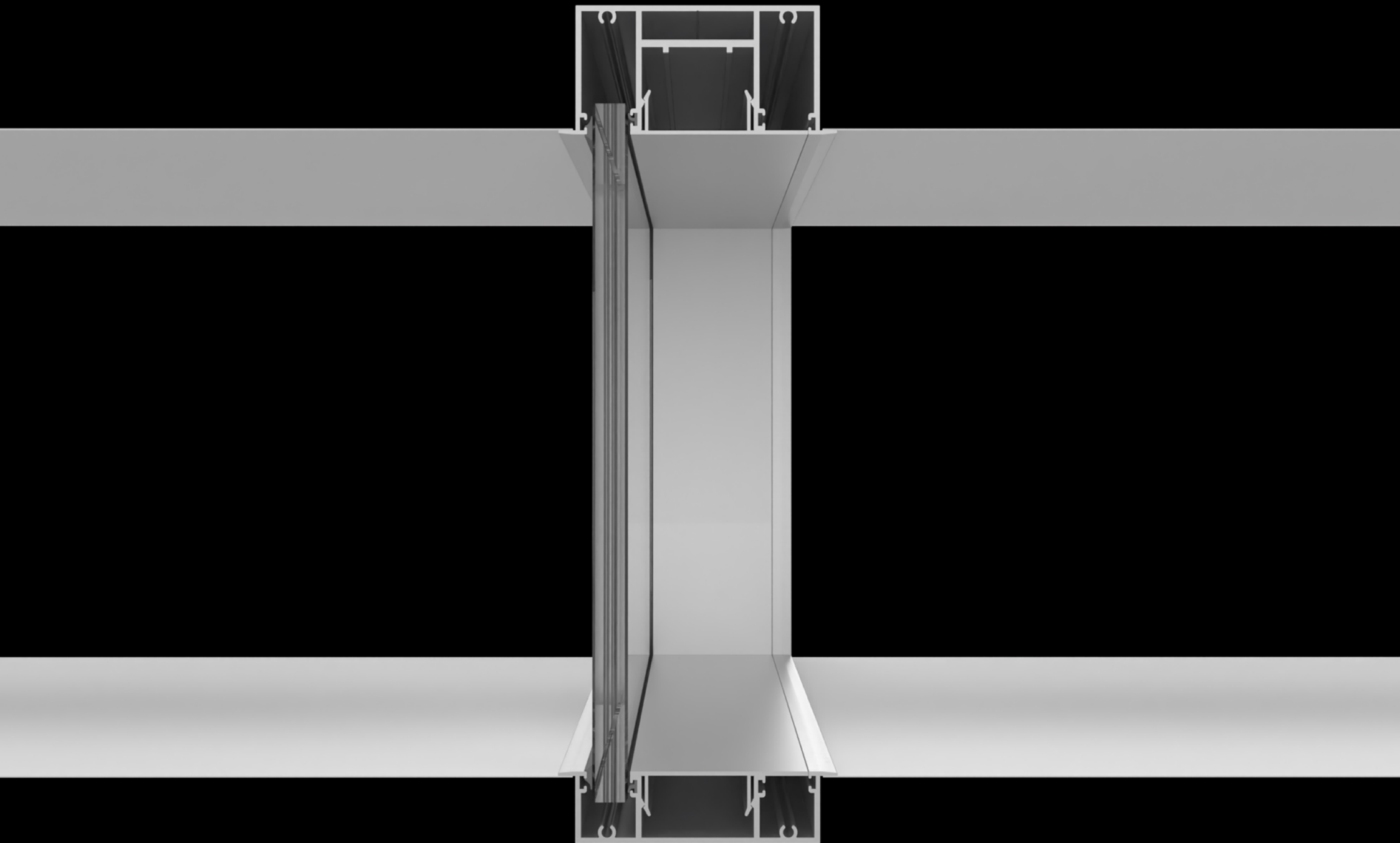

☐ ETOILE

**METRICA® FA**

---





- 01.** Spessore 97 mm
- 02.** Profili incassati a pavimento, a soffitto, angoli e partenze in estruso di alluminio 6060 UNI 9006/1
- 03.** Vetro singolo asimmetrico - spessore 55.1/55.2/66.1/66.2 o temperato 10/12 mm
- 04.** Profili d'angolo fissi e variabili - connessioni 2/3 vie
- 05.** Giunzioni verticali tra elementi vetrati in alluminio, policarbonato e biadesivo trasparente
- 06.** Modulo tecnico
- 07.** 5 versioni di porte battenti - cieche, in vetro temperato e intelaiate





# Partenze

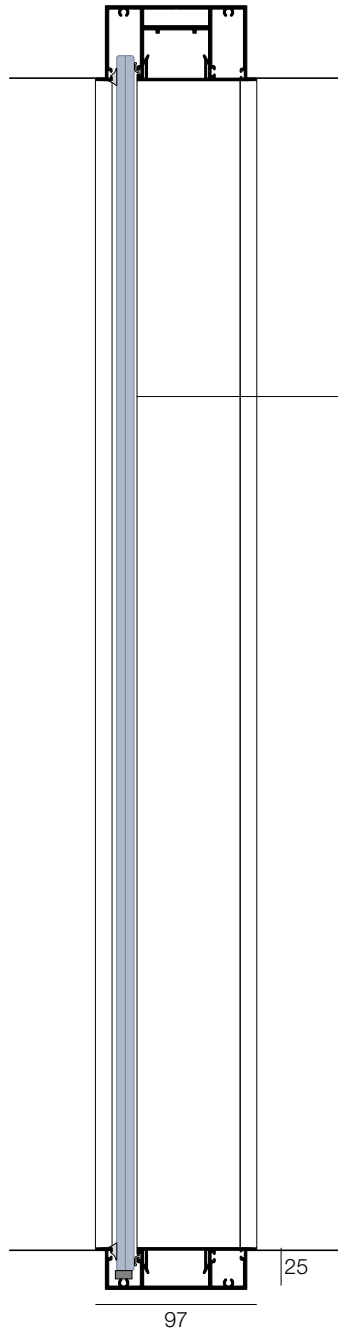

*vetro 55.1 stratificato*  
*vetro 55.2 stratificato*  
*vetro 66.1 stratificato*  
*vetro 66.2 stratificato*  
  
*vetro 10 mm temperato*  
*vetro 12 mm temperato*

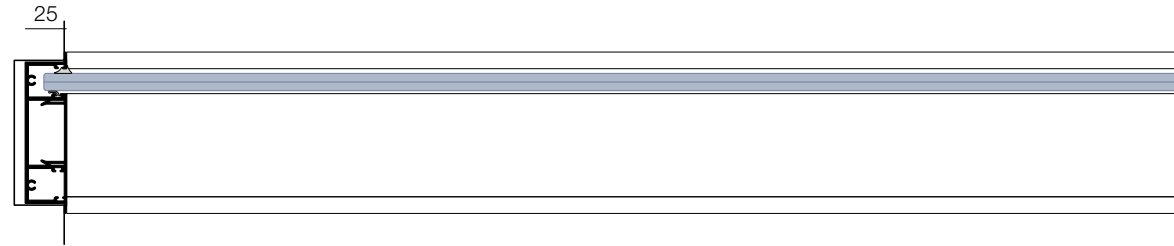

**Partenza incassata a parete**

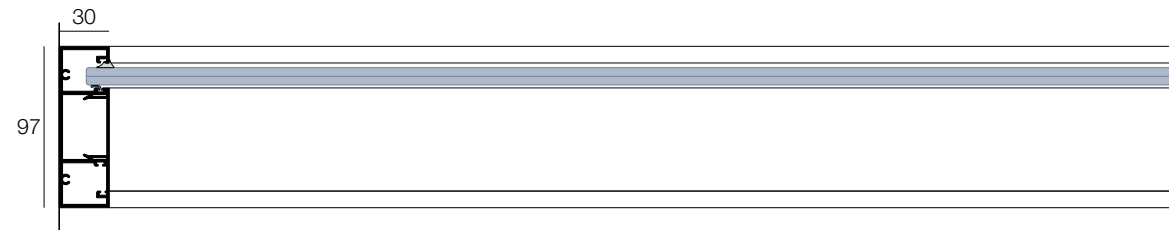

**Partenza fissa da parete**

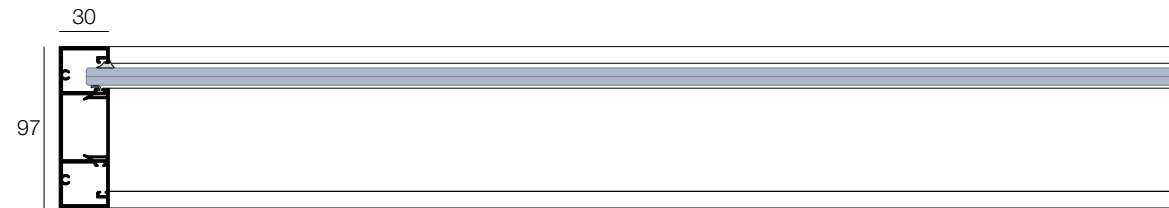

**Profilo terminale**



Partenza da contenitore

Partenza da contenitore incassata

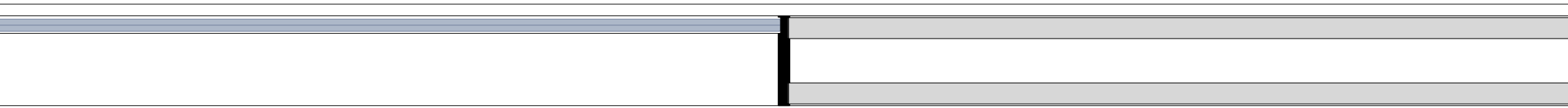

**Connessione in alluminio  
metrica fa - metrica f solid**

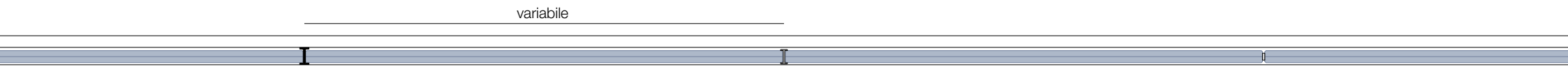

**Connessione  
in alluminio**

**Connessione  
in policarbonato**

**Connessione  
con biadesivo tecnico**

# Angoli

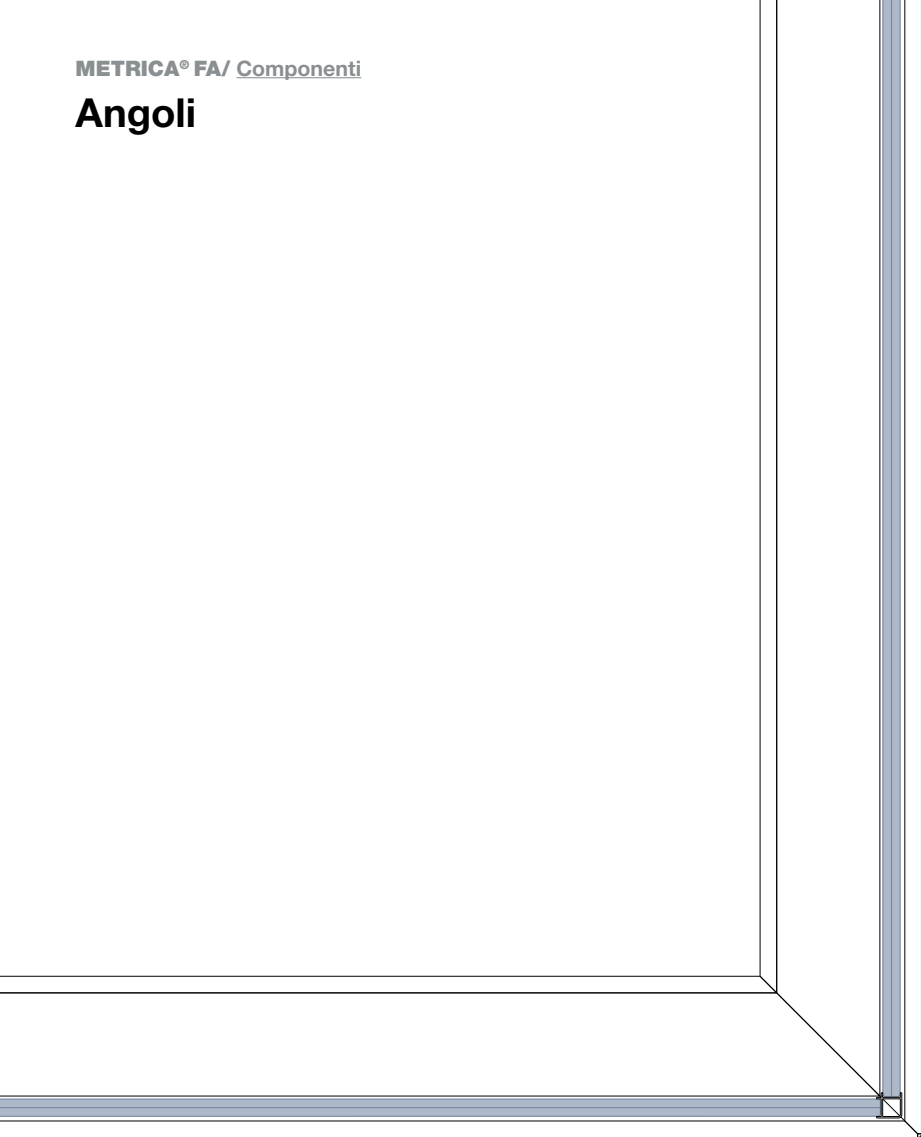

**Angolo a 90°  
in policarbonato**

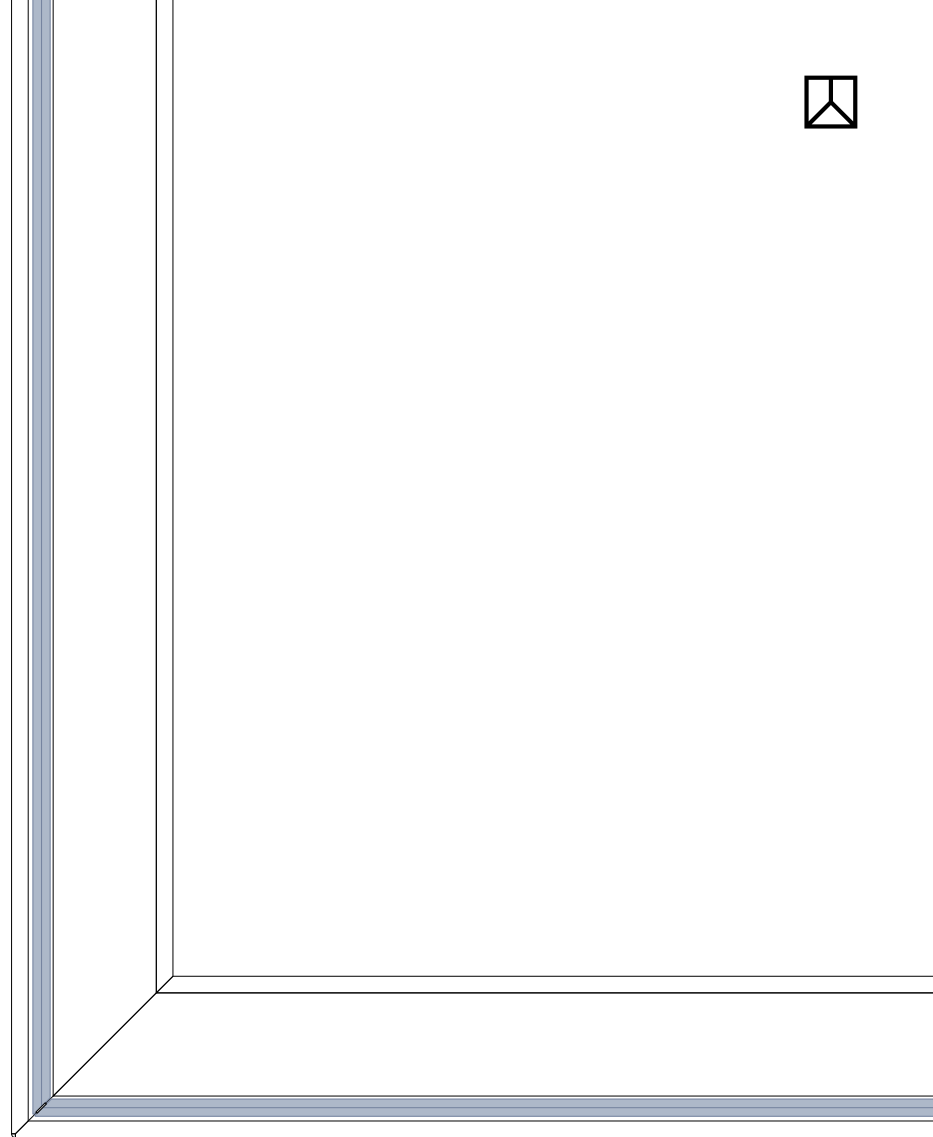

**Angolo a 90°  
con biadesivo tecnico**

# Modulo tecnico della porta a battente



## Modulo tecnico

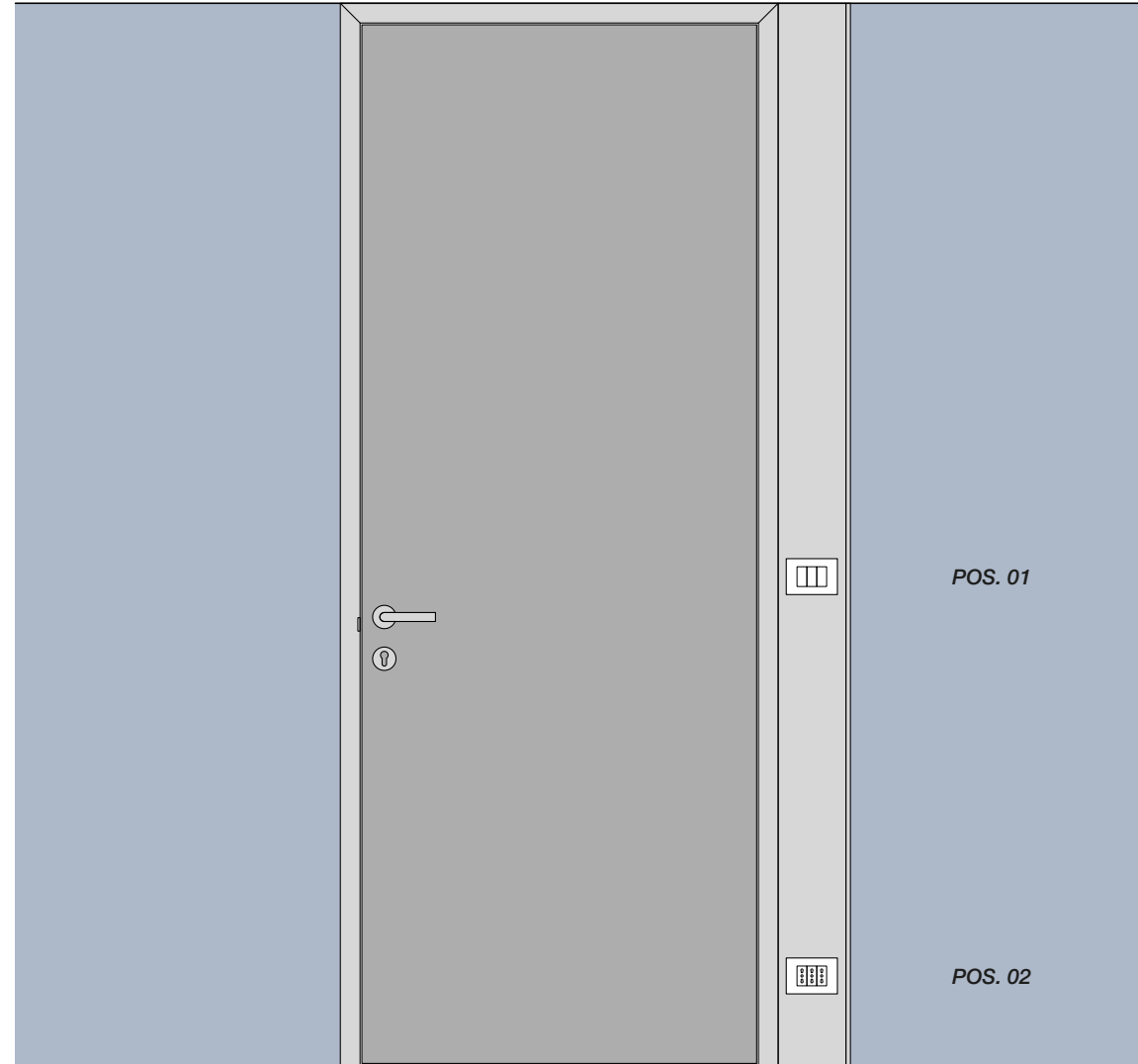
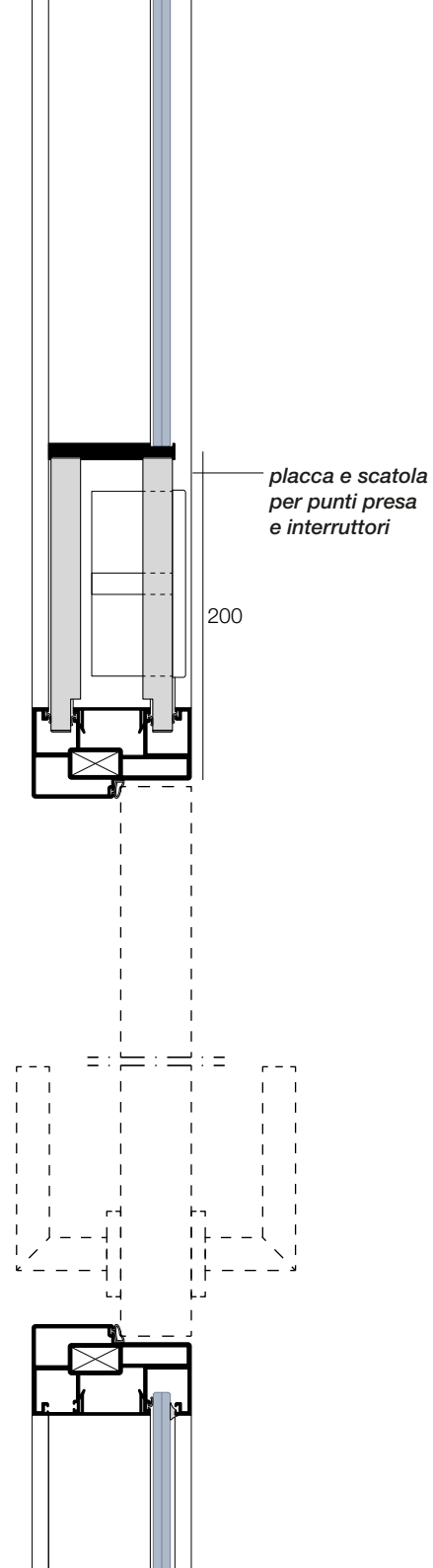

*\*posizioni possibili di interruttori e prese su modulo tecnico*

**METRICA**<sup>®</sup>  
SENZA STRUTTURA

Porte e maniglie

---

# TELAI PORTE BATTENTI

## Metrica D



Telaio porta **Metrica D** su **Metrica D1**

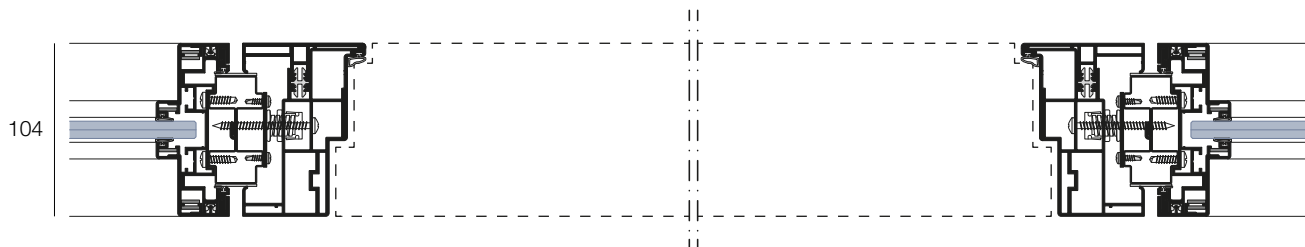

Telaio porta **Metrica D** su **Metrica D2**

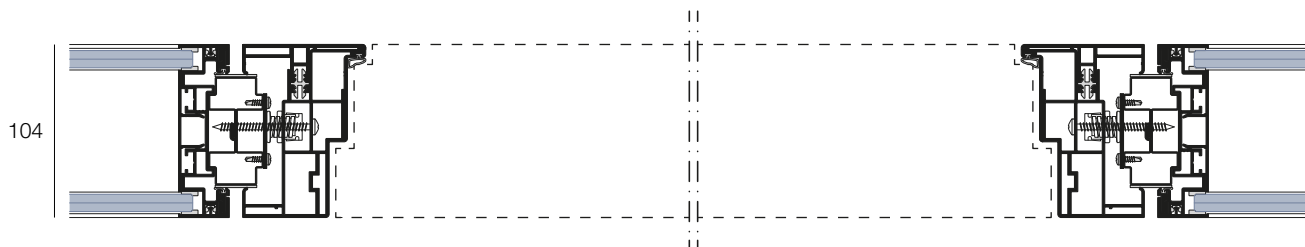

Telaio porta **Metrica D** su **Metrica Solid**

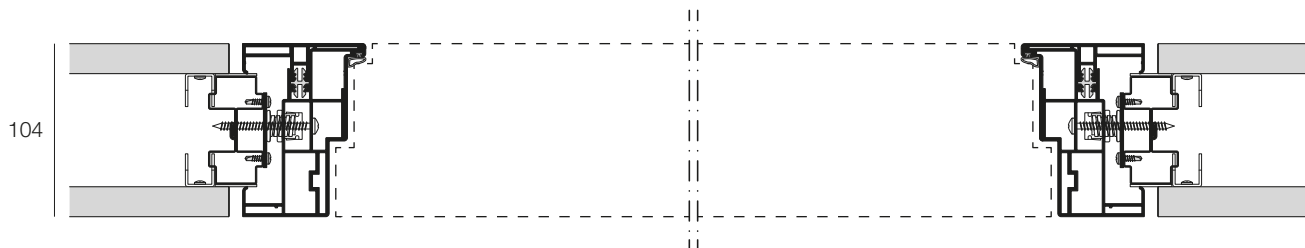



# ANTA INTELAIATA CIECA\_CON DOPPIA BATTUTA sp. 104 mm



Porta complanare

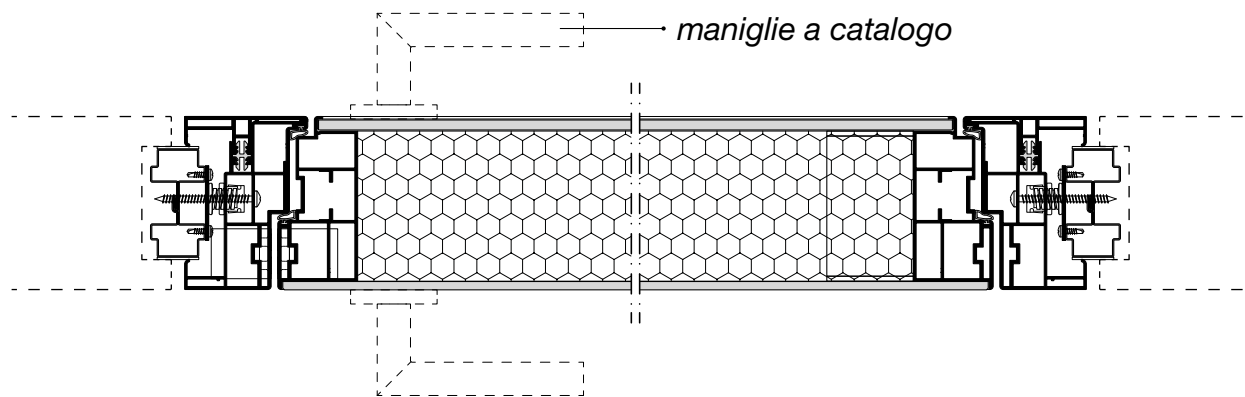
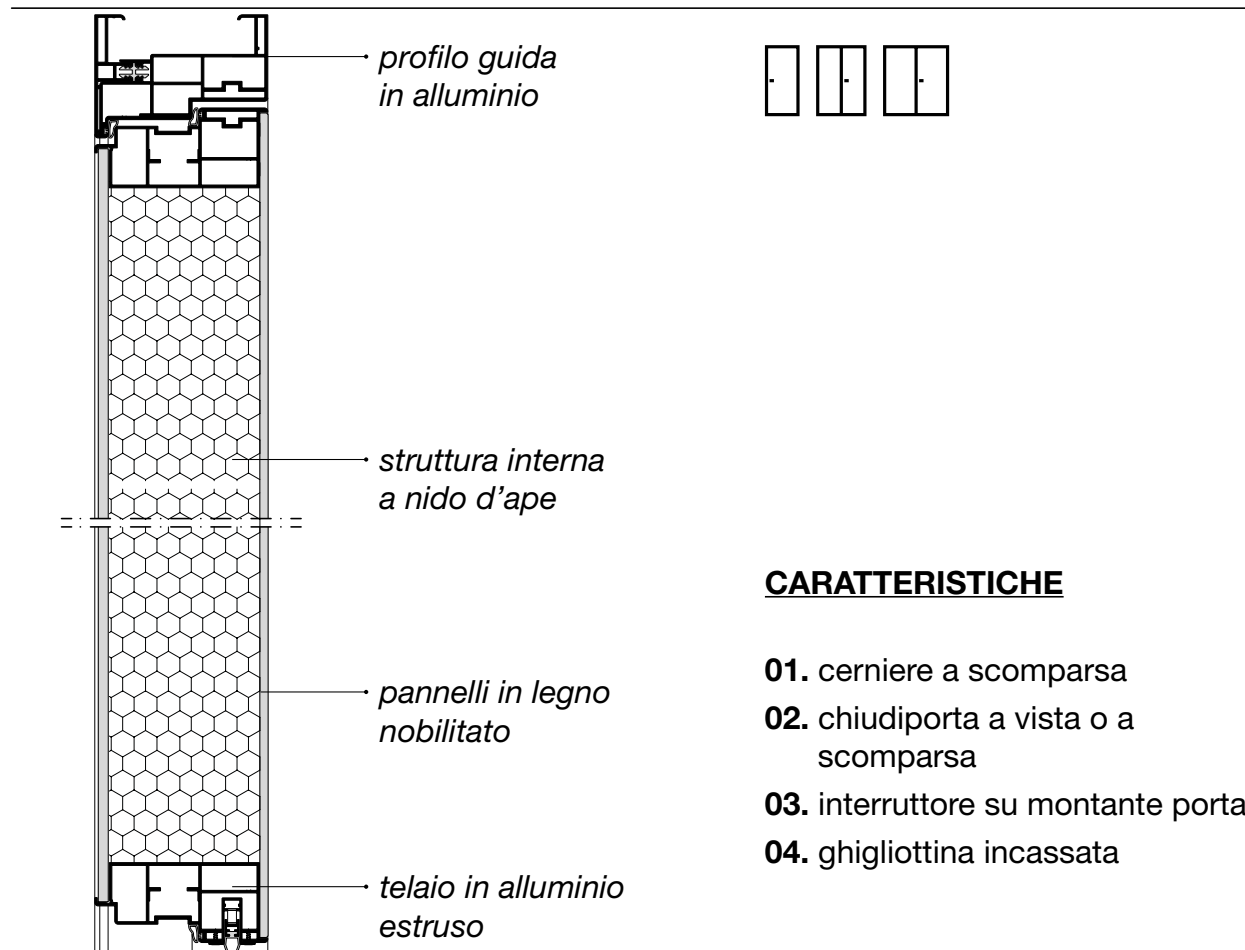

# ANTA INTELAIATA CIECA\_ CON DOPPIA BATTUTA sp. 104 mm

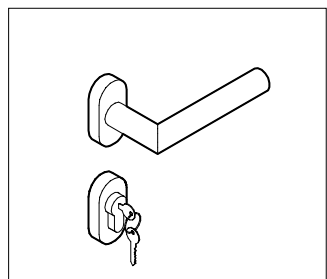

**ML5**

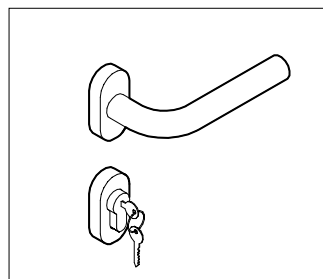

**ML6**

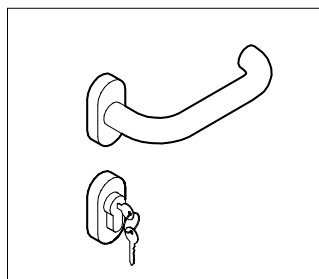

**ML7**

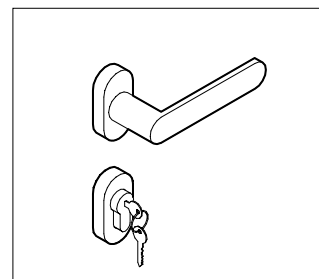

**ML8**

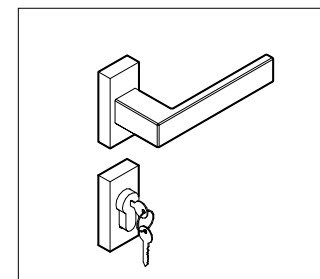

**ML9**

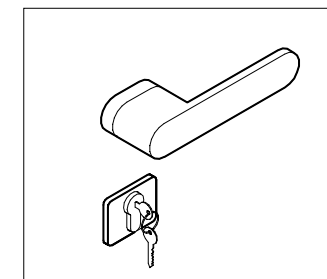

**ML10**

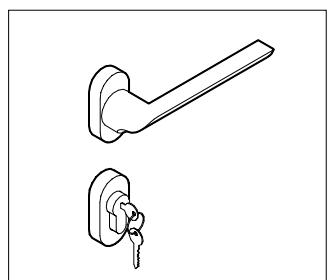

**ML11**

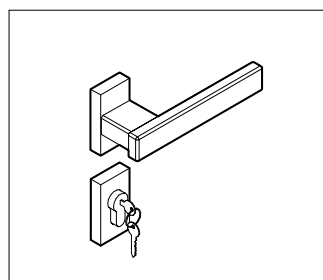

**MLQ**

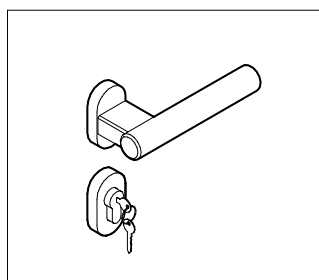

**MLT**

# ANTA INTELAIATA VETRO DOPPIO SERIGRAFATO\_CON DOPPIA BATTUTA sp. 104 mm



Porta complanare

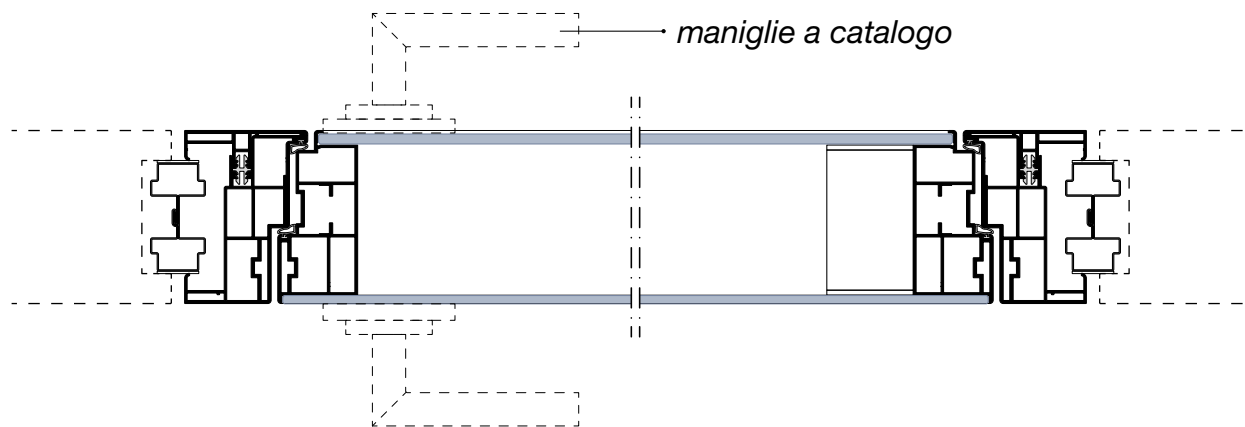
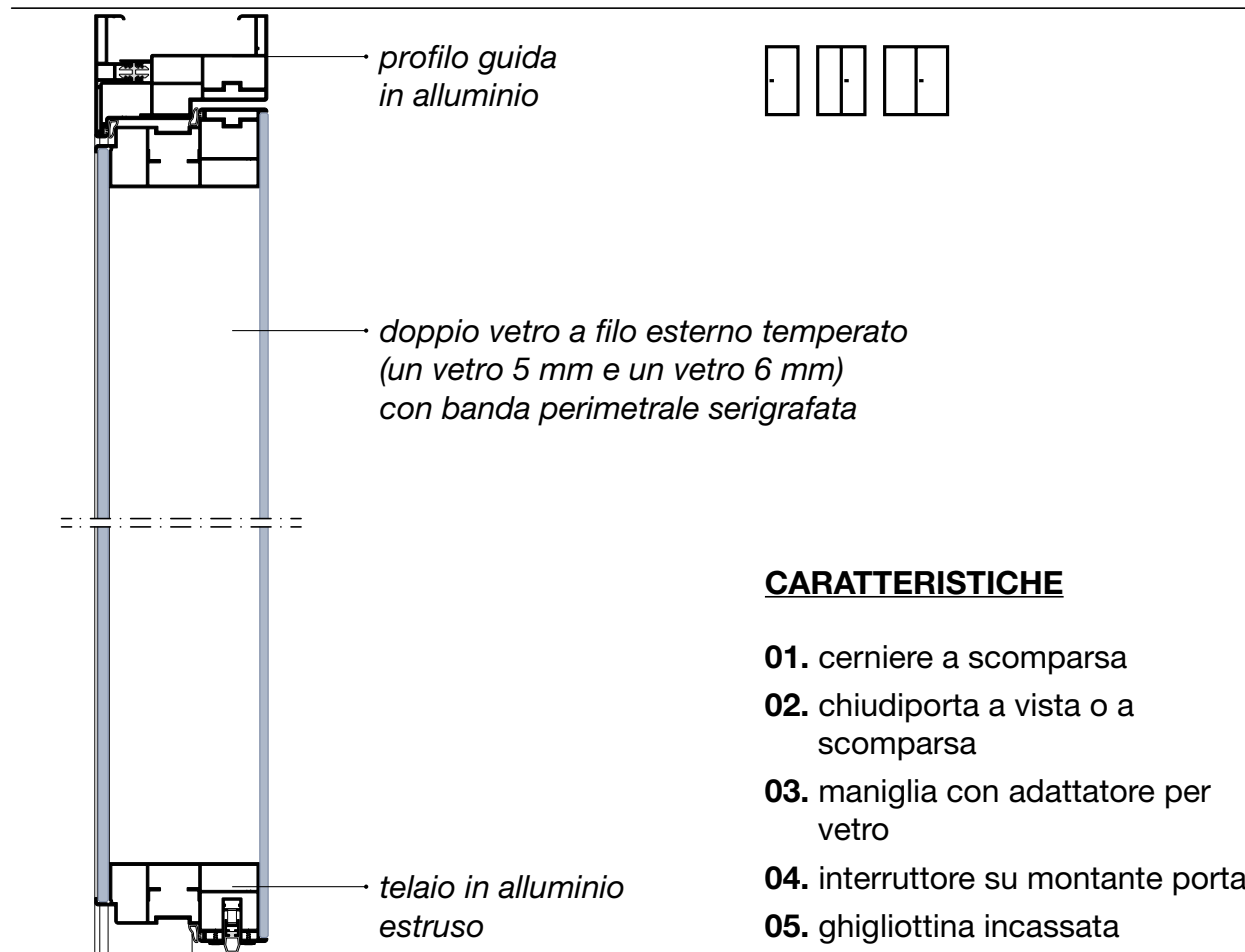

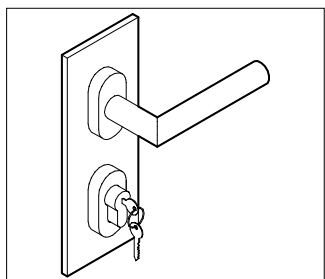

ML5

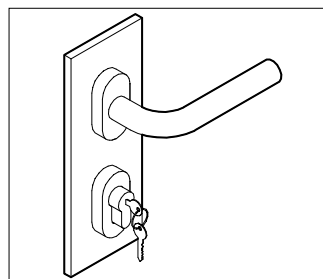

ML6

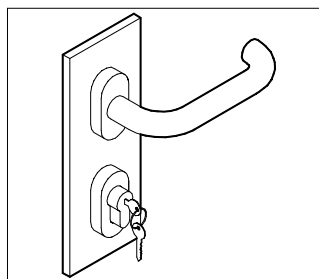

ML7

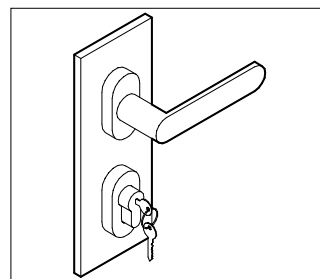

ML8

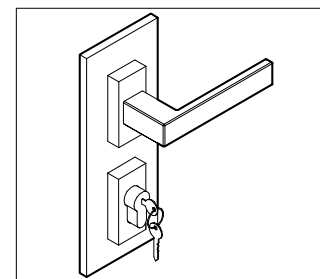

ML9

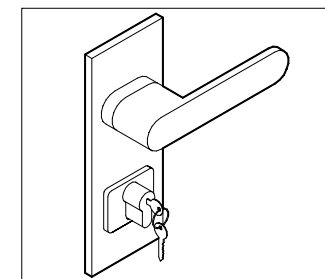

ML10

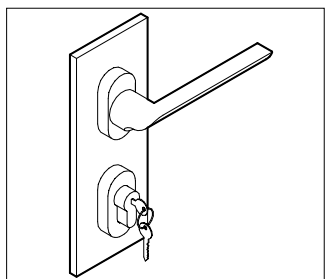

ML11

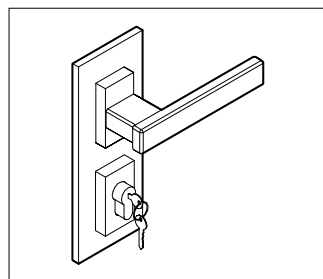

MLQ

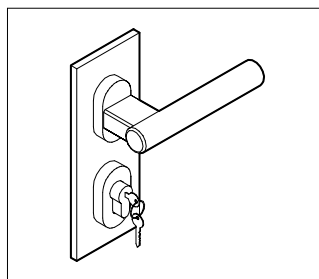

MLT

# TELAI PORTE BATTENTI

## Metrica strutturale



Telaio porta **Metrica Strutturale** su **Metrica D1**

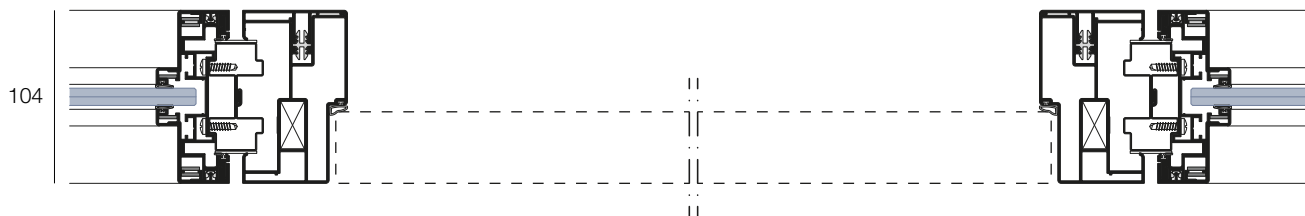

Telaio porta **Metrica Strutturale** su **Metrica D2**

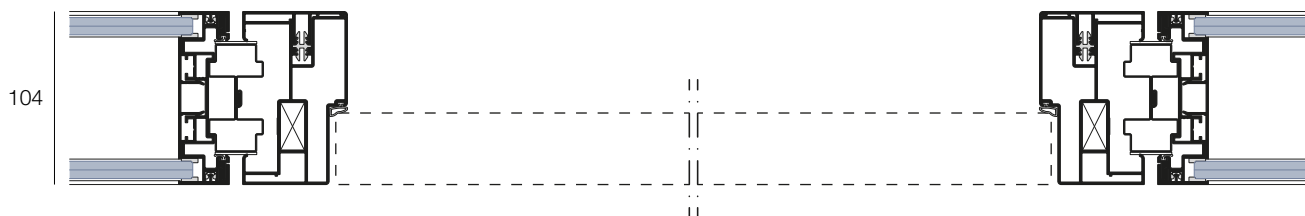

Telaio porta **Metrica Strutturale** su **Metrica Solid**

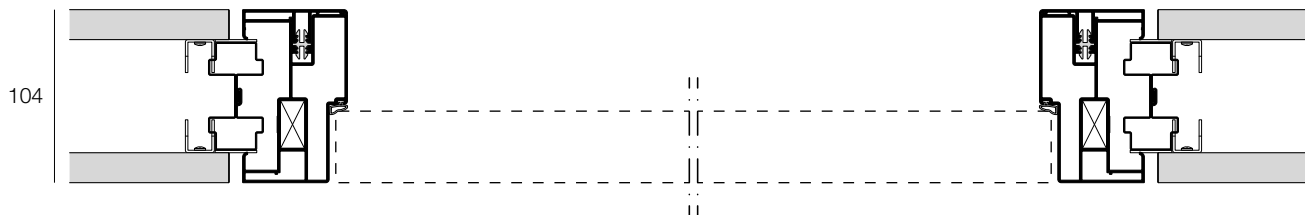

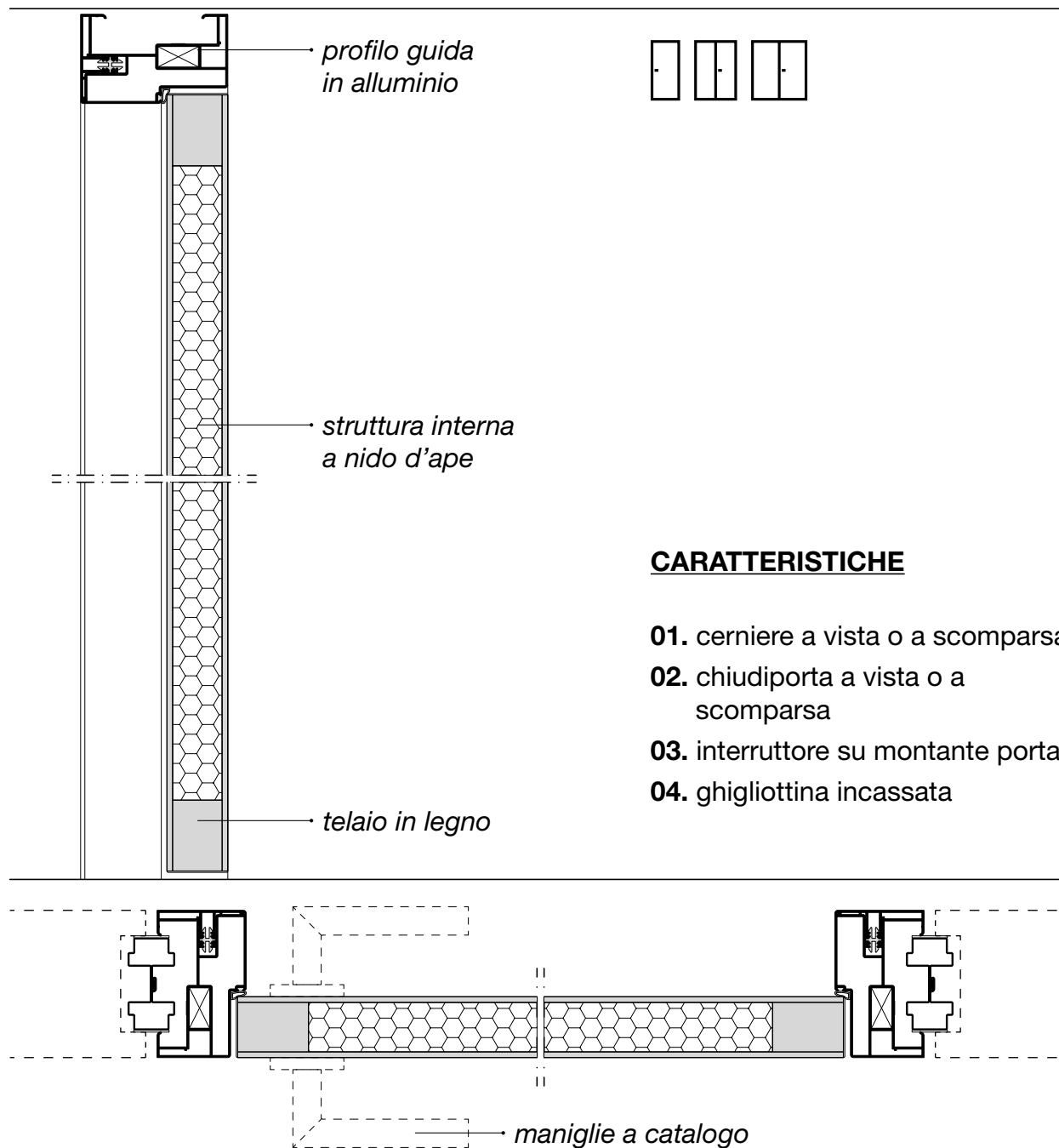

**ANTA CIECA** sp. 43 mm

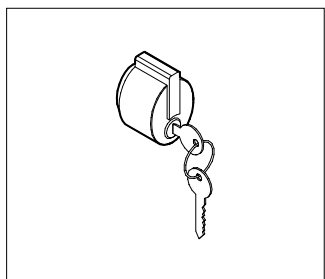

**ML1**

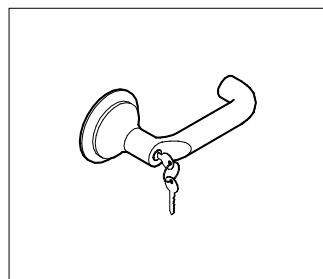

**ML4**

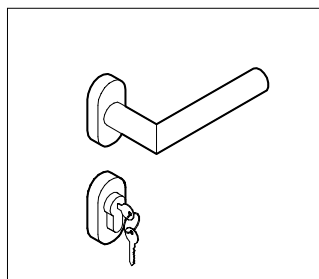

**ML5**

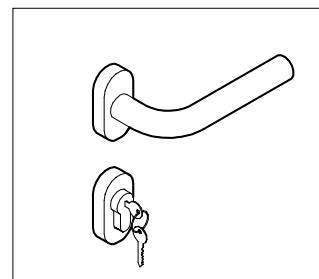

**ML6**

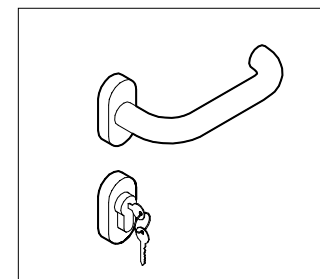

**ML7**

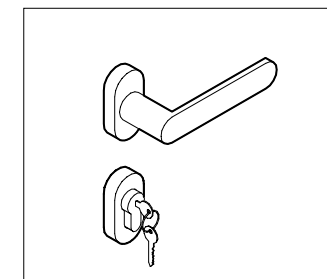

**ML8**

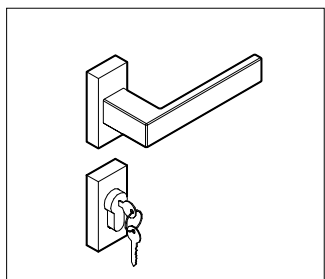

**ML9**

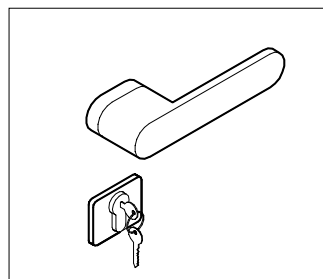

**ML10**

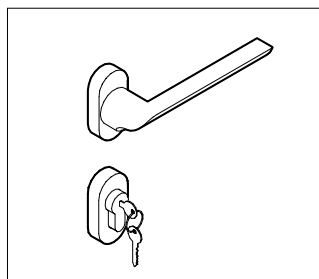

**ML11**

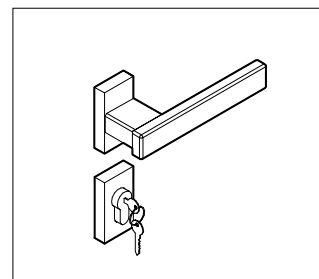

**MLQ**

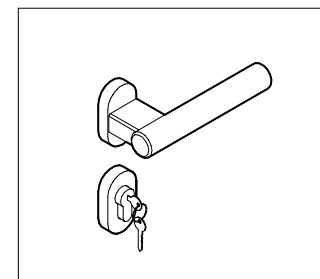

**MLT**

# ANTA VETRO TEMPERATO\_CERNIERE A VISTA sp. 10 mm

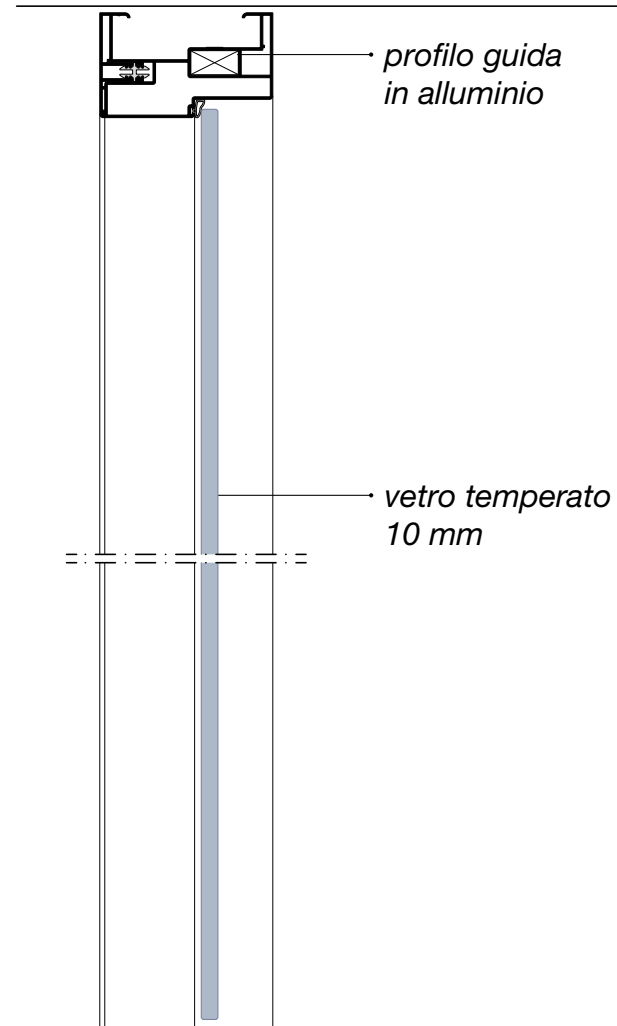
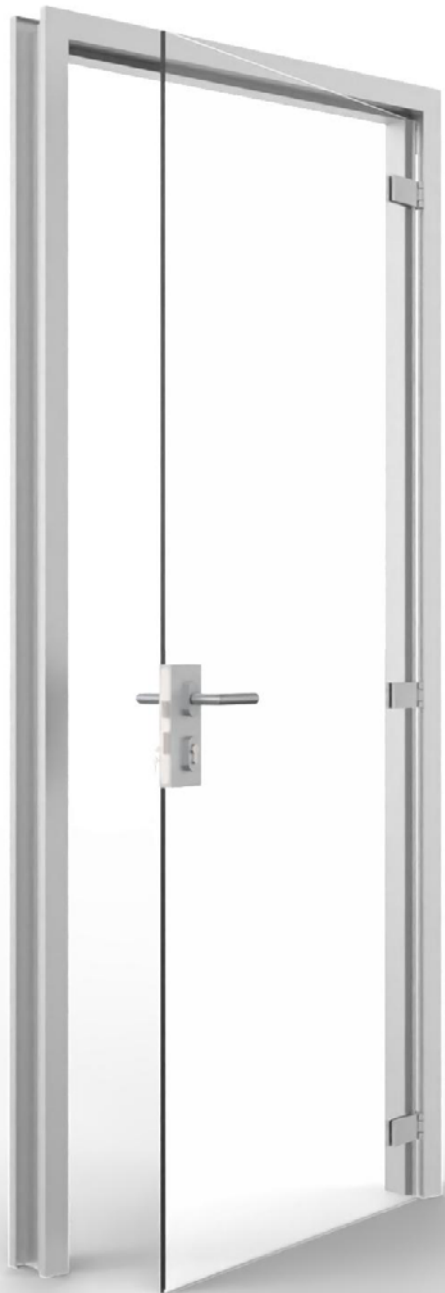

## **CARATTERISTICHE**

- 01.** cerniere a vista - 110° o 180°
- 02.** chiudiporta a vista
- 03.** maniglia con adattatore per vetro
- 04.** interruttore su montante porta
- 05.** ghigliottina esterna

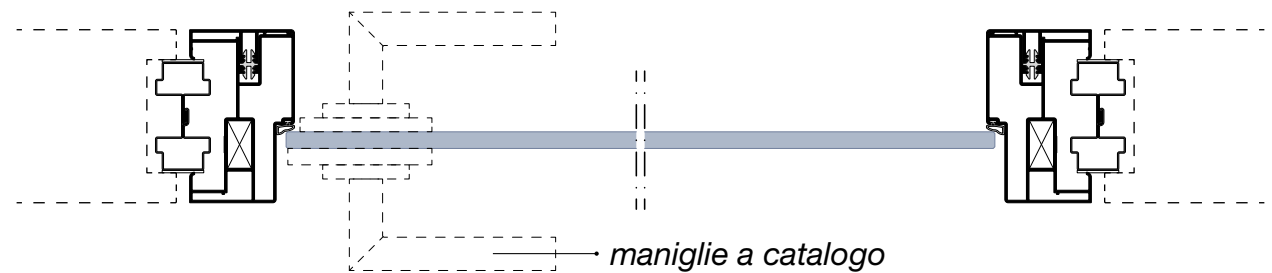



# ANTA VETRO TEMPERATO\_CERNIERE A VISTA sp. 10 mm

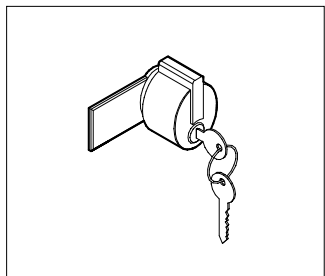

MC1

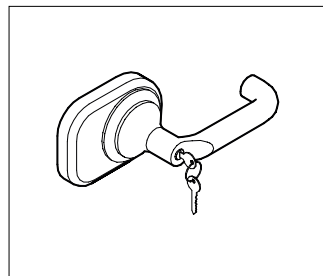

MC4

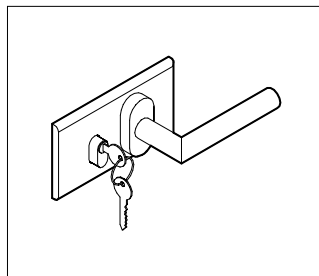

MC5

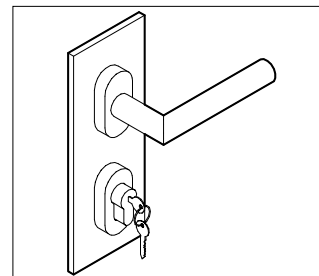

MC5V

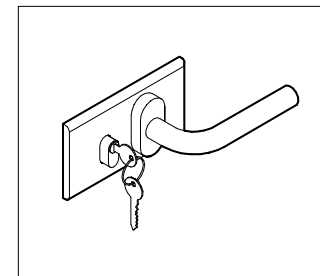

MC6

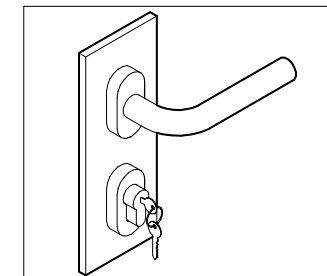

MC6V

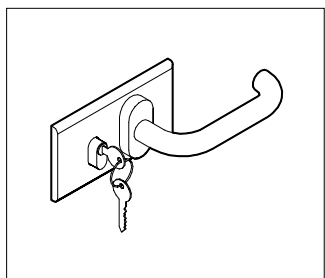

MC7

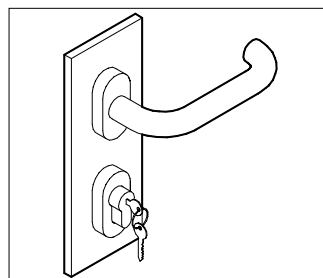

MC7V

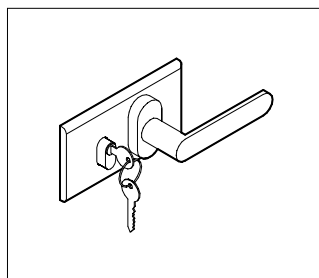

MC8

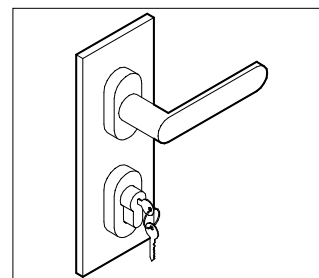

MC8V

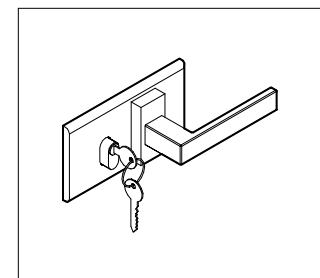

MC9

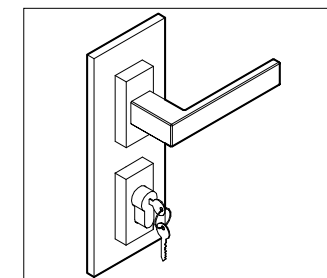

MC9V

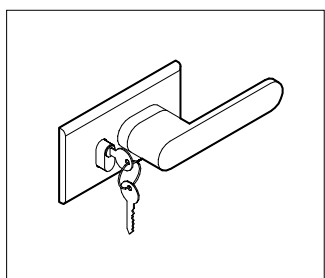

MC10

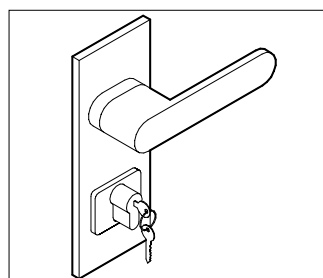

MC10V

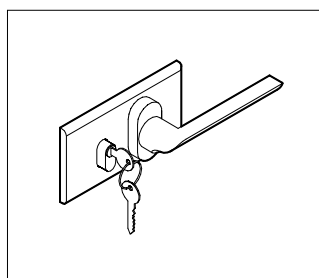

MC11

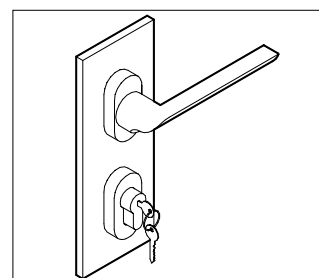

MC11V

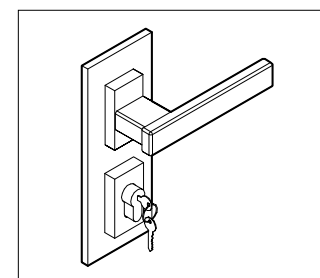

MCQ

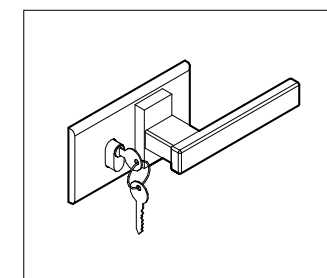

MCQO

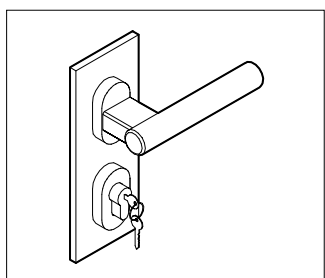

MCT

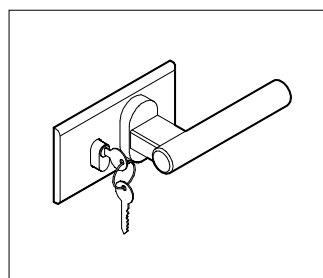

MCTO

# ANTA VETRO TEMPERATO\_CERNIERA CONTINUA sp. 10 mm

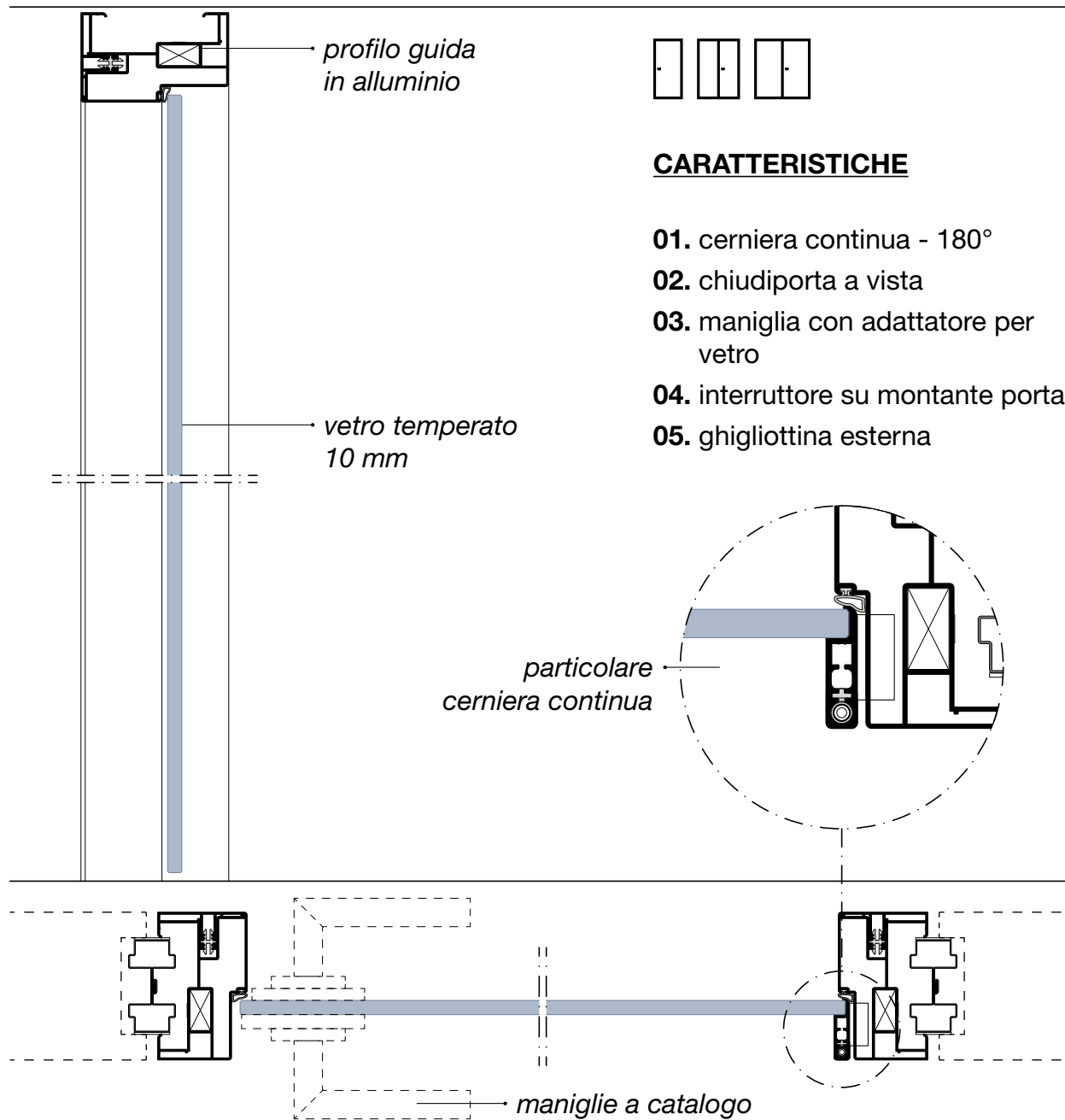
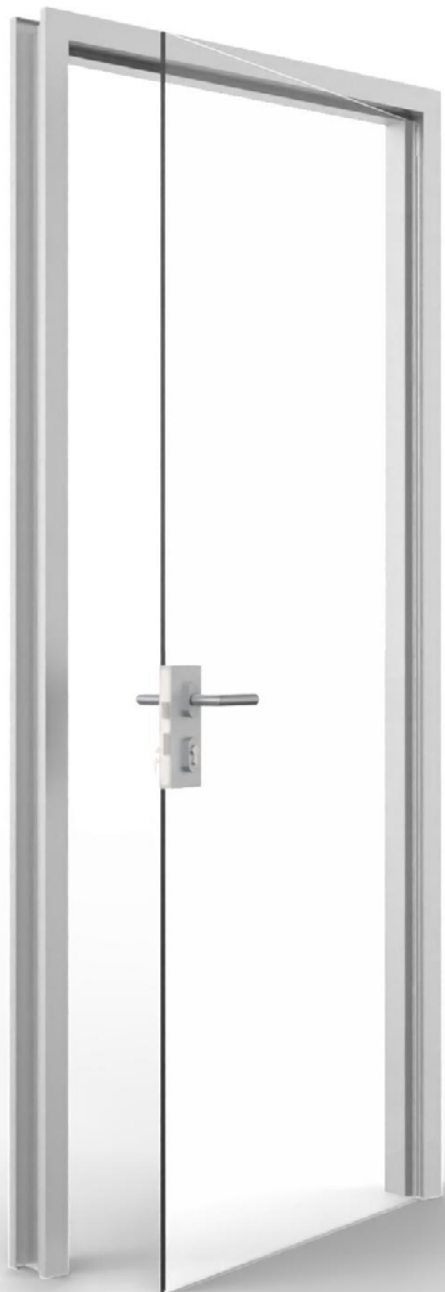

# ANTA VETRO TEMPERATO\_CERNIERA CONTINUA sp. 10 mm

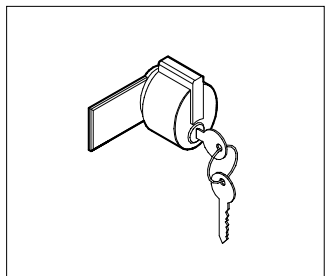

MC1

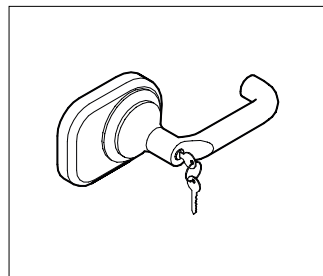

MC4

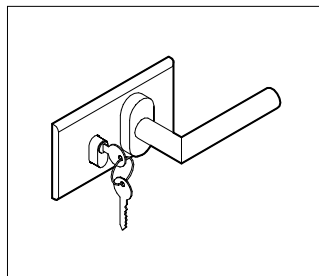

MC5

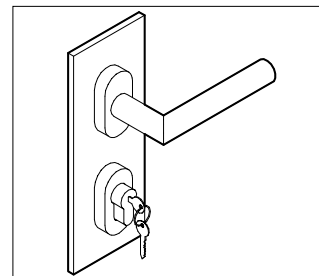

MC5V

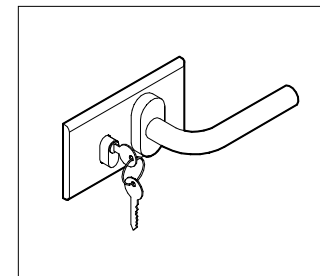

MC6

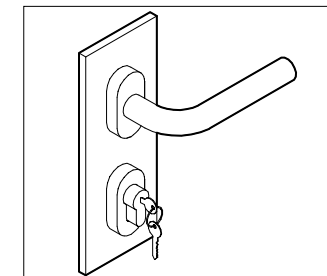

MC6V

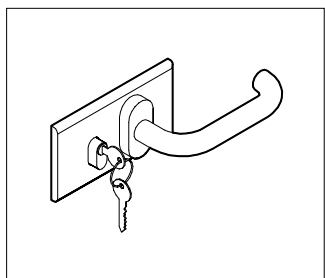

MC7

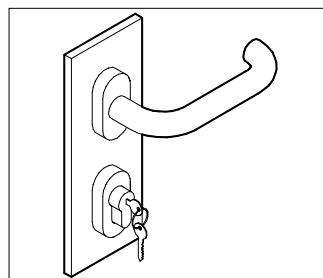

MC7V

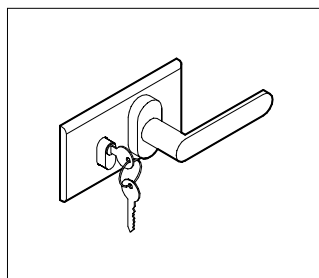

MC8

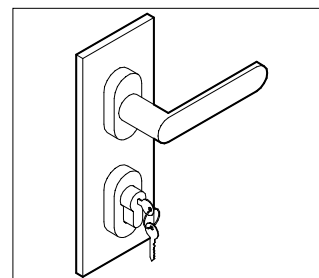

MC8V

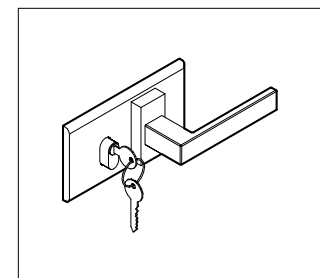

MC9

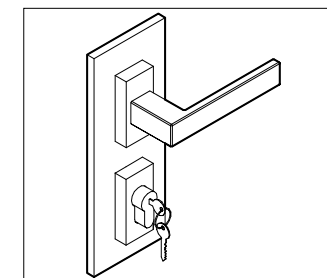

MC9V

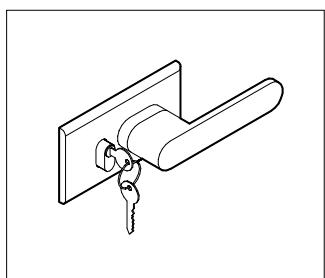

MC10

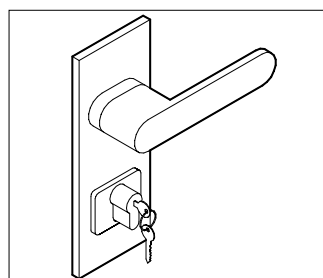

MC10V

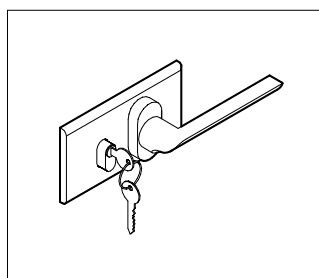

MC11

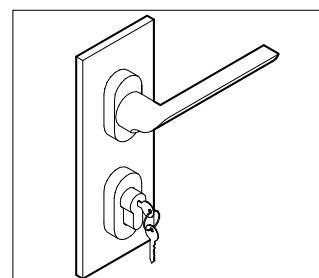

MC11V

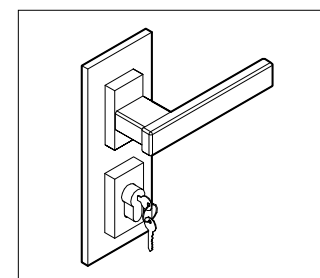

MCQ

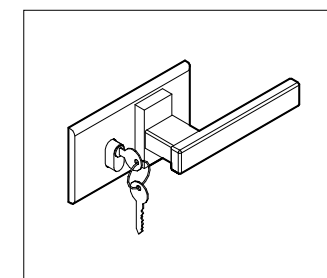

MCQO

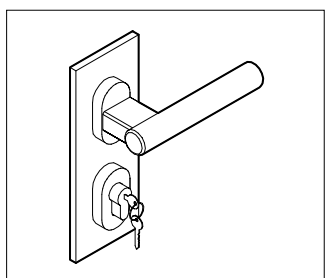

MCT

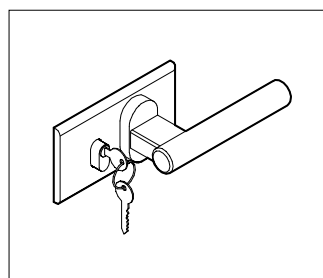

MCTO

# ANTA INTELAIATA GRANDE CON PANNELLO sp. 43 mm

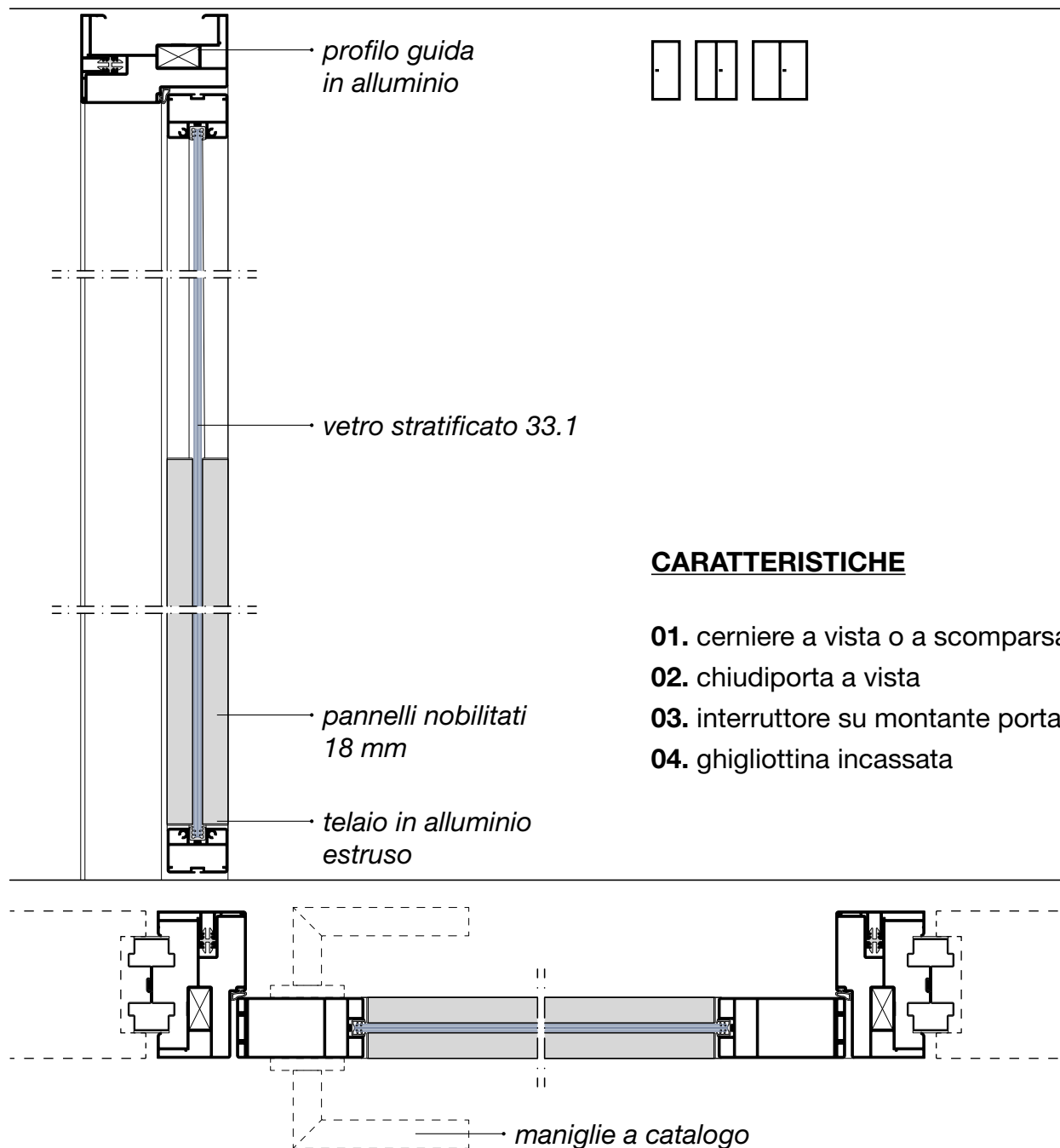

# ANTA INTELAIATA GRANDE CON PANNELLO sp. 43 mm

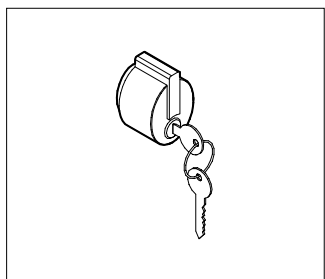

ML1

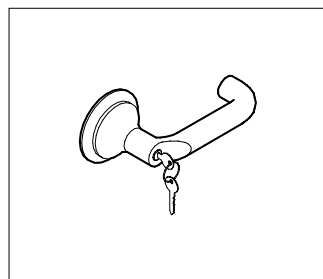

ML4

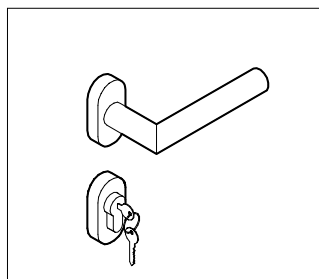

ML5

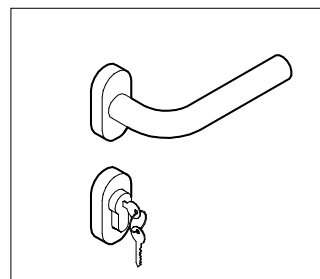

ML6

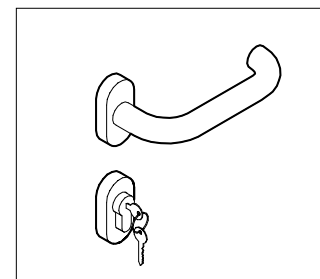

ML7

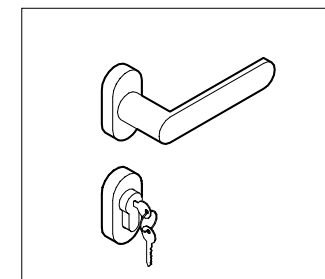

ML8

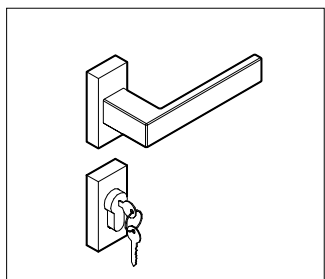

ML9

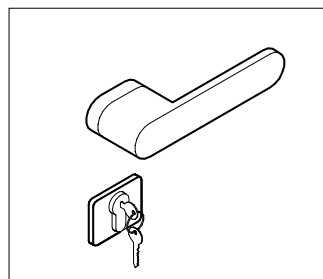

ML10

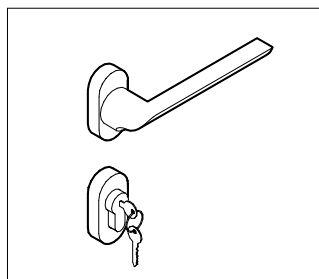

ML11

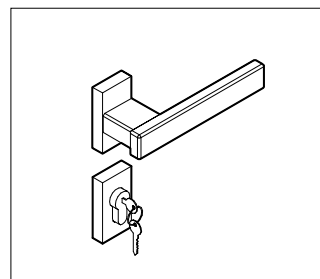

MLQ

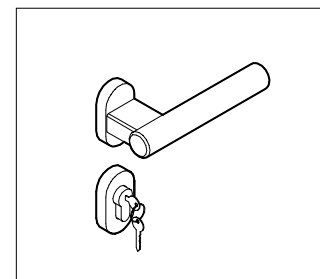

MLT

# ANTA INTELAIATA GRANDE sp. 43 mm

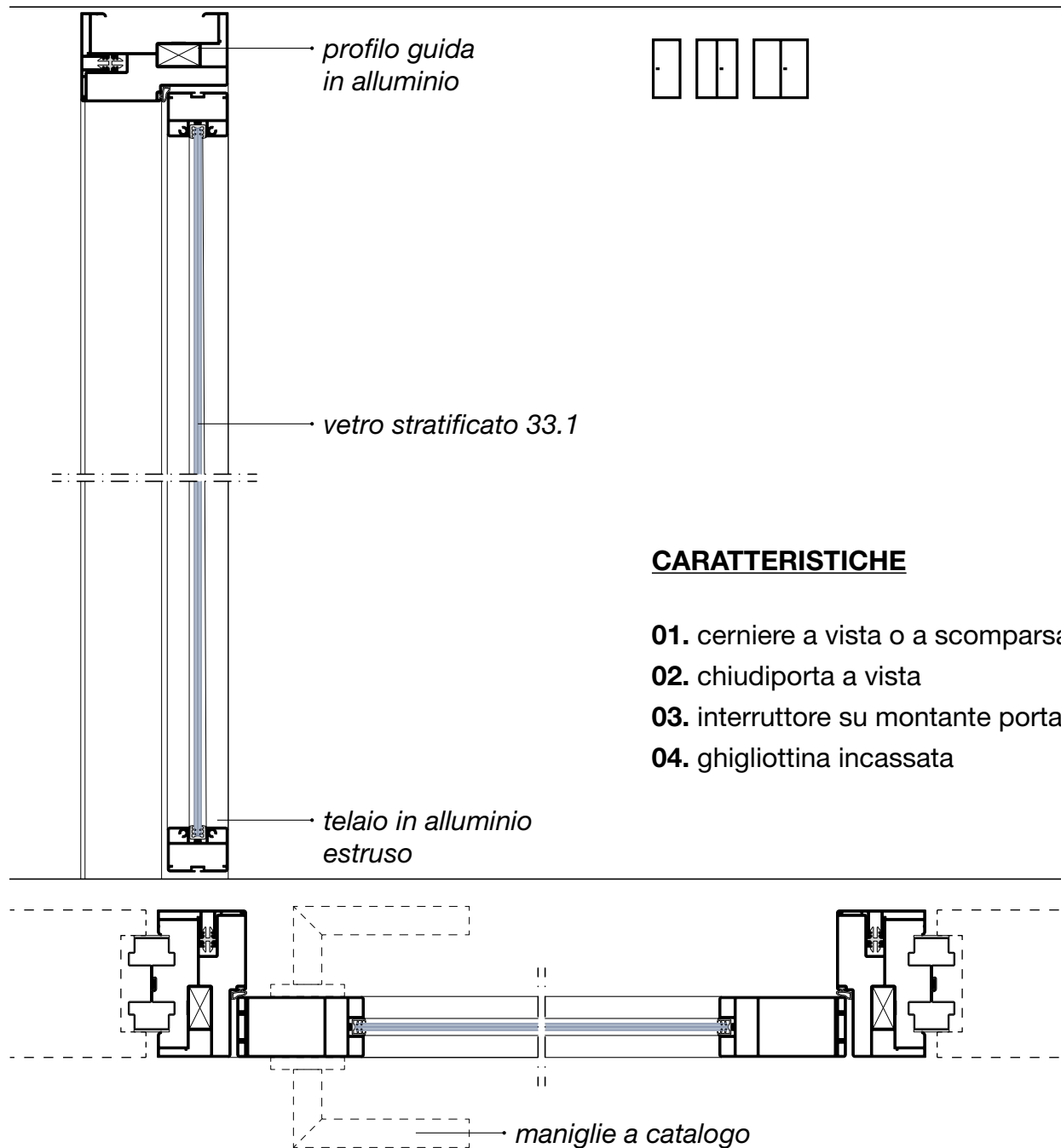

# ANTA INTELAIATA GRANDE sp. 43 mm

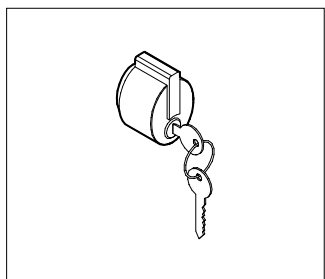

ML1

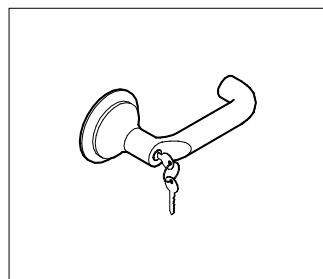

ML4

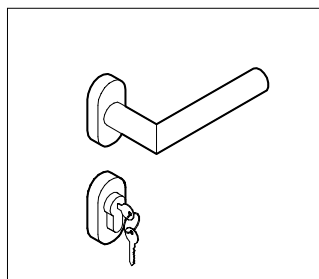

ML5

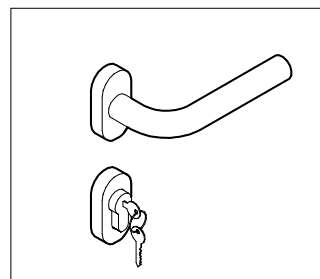

ML6

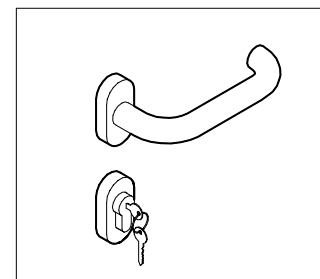

ML7

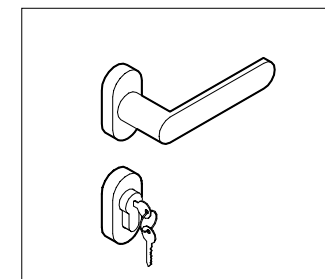

ML8

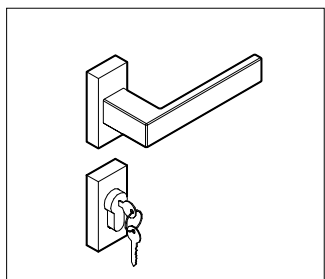

ML9

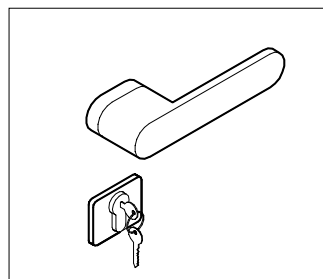

ML10

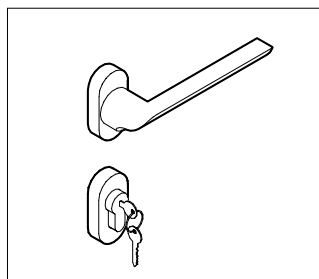

ML11

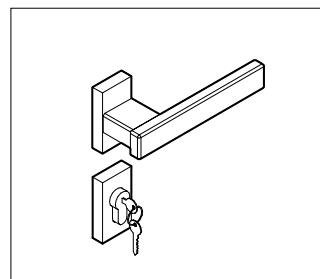

MLQ

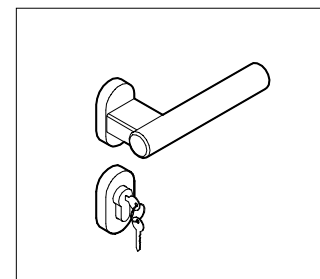

MLT

# ANTA INTELAIATA MEDIA sp. 43 mm

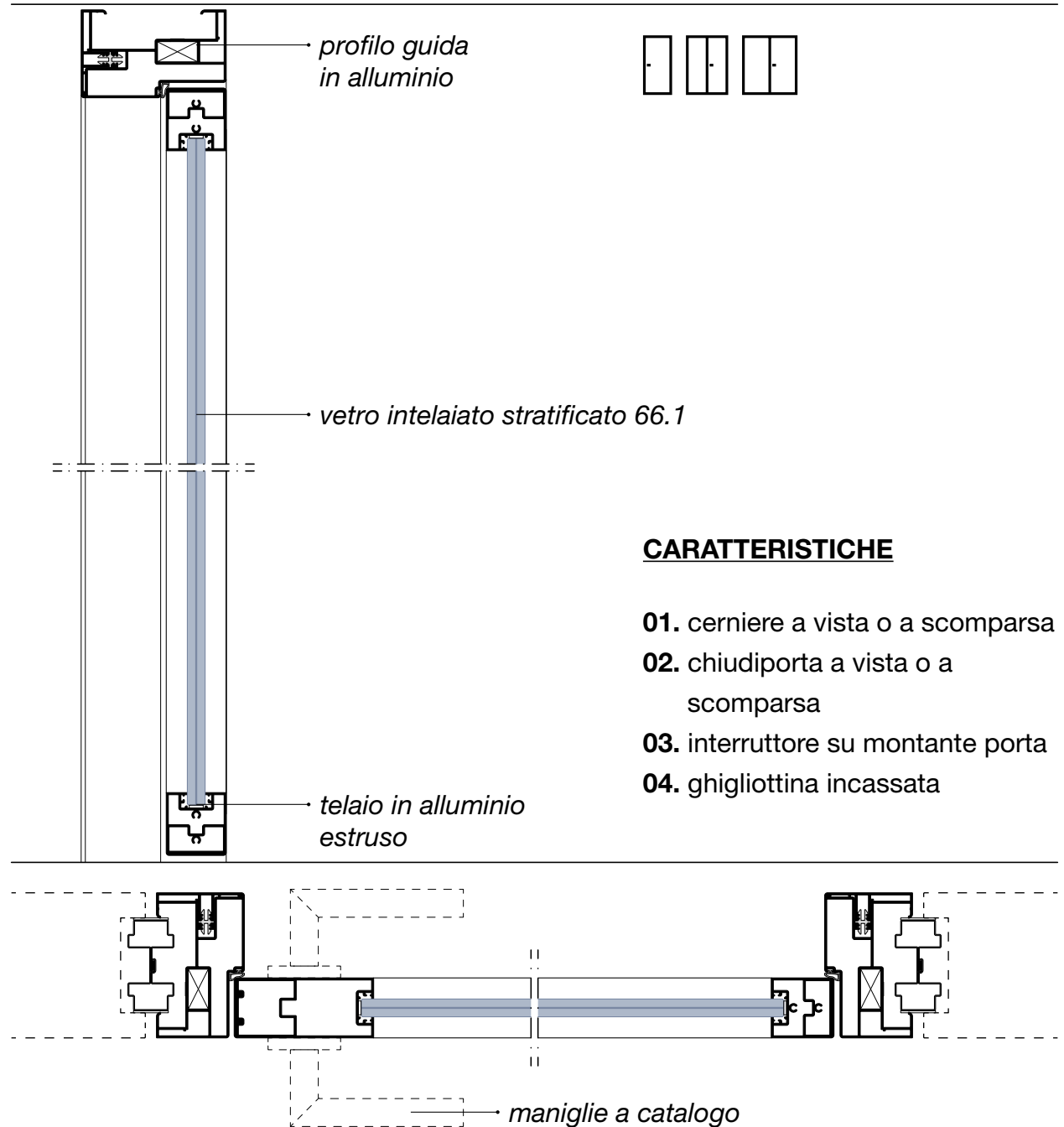



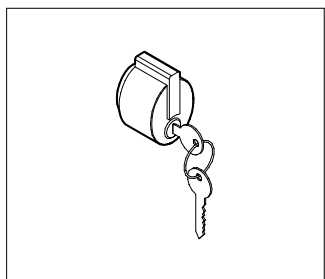

**ML1**

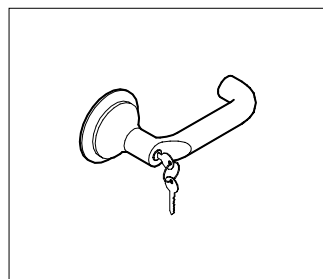

**ML4**

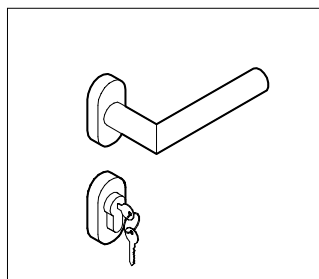

**ML5**

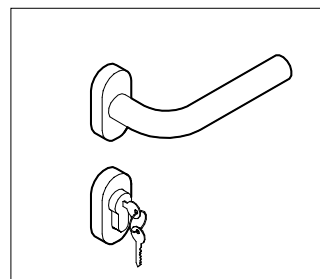

**ML6**

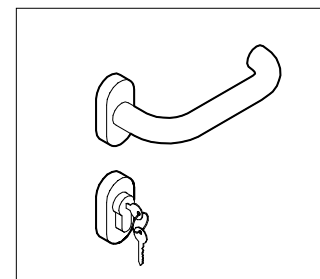

**ML7**

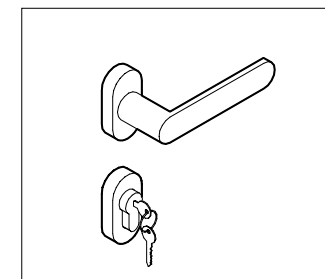

**ML8**

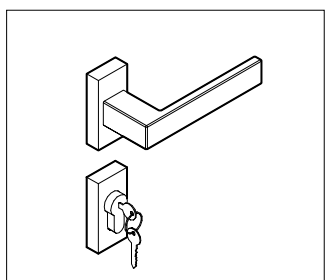

**ML9**

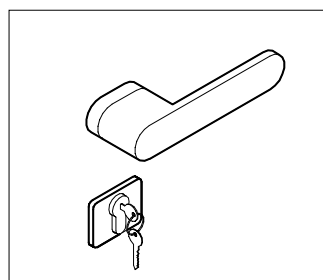

**ML10**

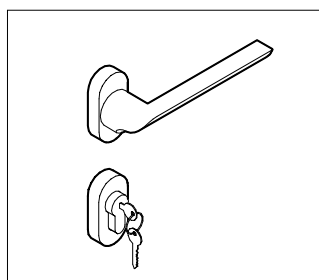

**ML11**

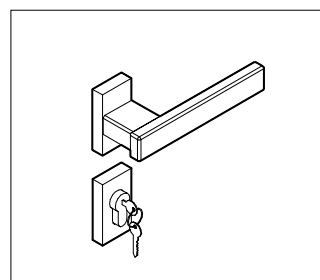

**MLQ**

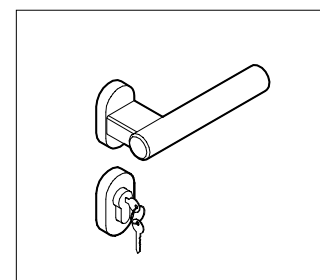

**MLT**

# ANTA INTELAIATA SOTTILE sp. 43 mm

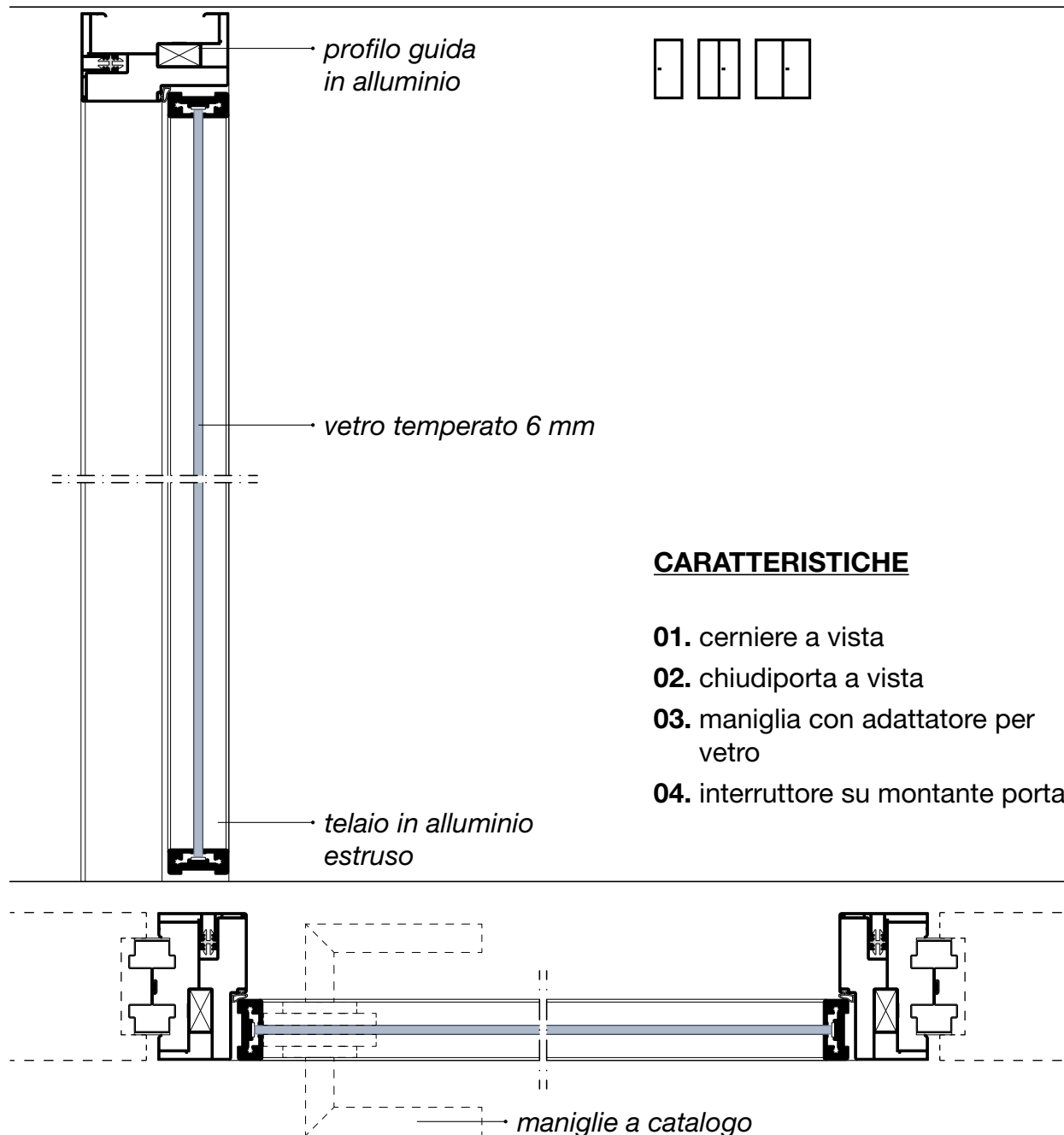

# ANTA INTELAIATA SOTTILE sp. 43 mm

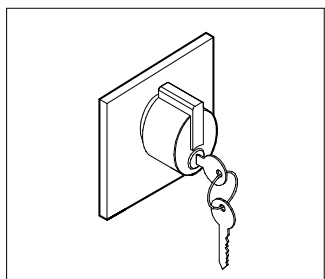

ML1

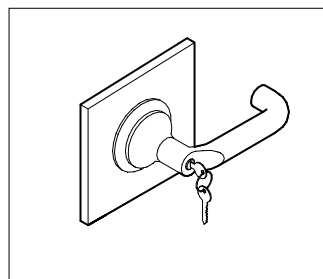

ML4

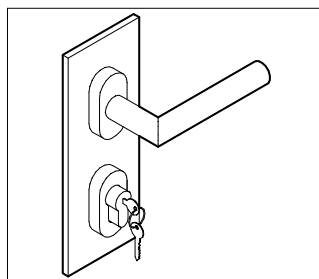

ML5

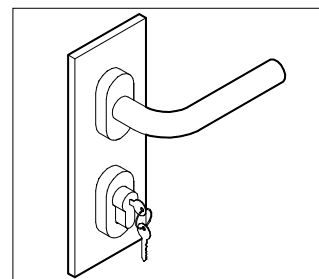

ML6

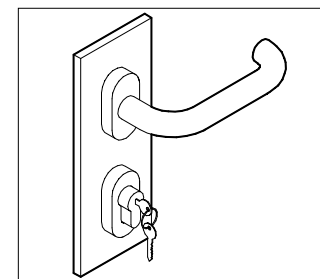

ML7

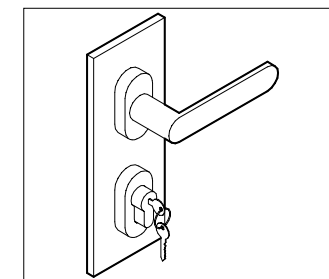

ML8

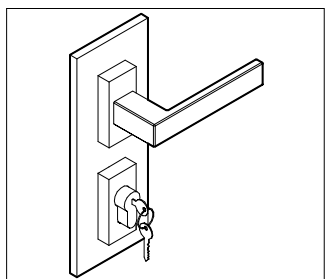

ML9

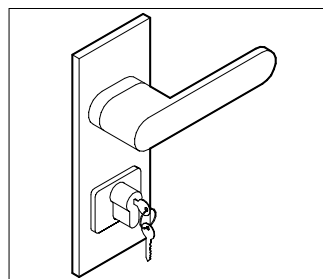

ML10

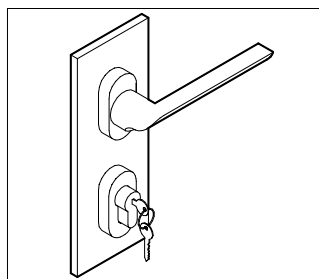

ML11

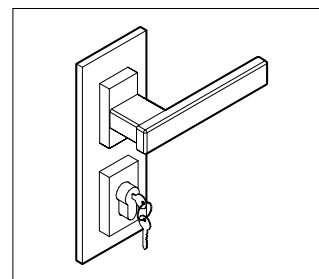

MLQ

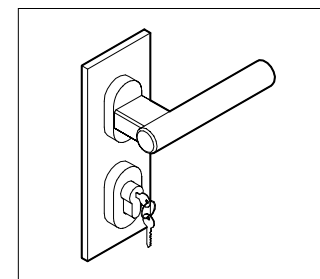

MLT

# ANTA INTELAIATA VETRO DOPPIO sp. 51 mm

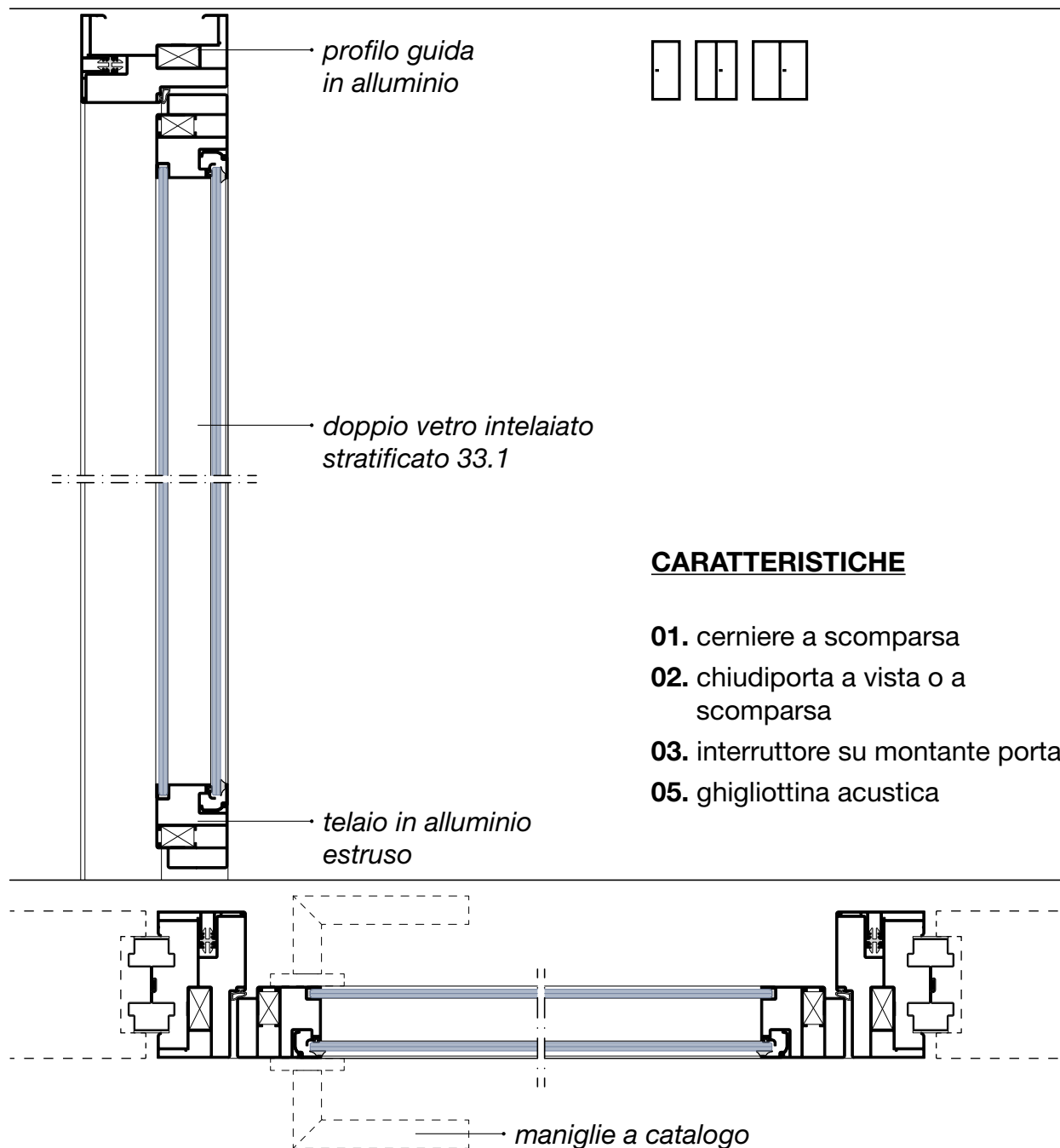

# ANTA INTELAIATA VETRO DOPPIO sp. 51 mm

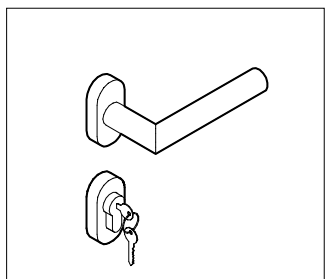

ML5

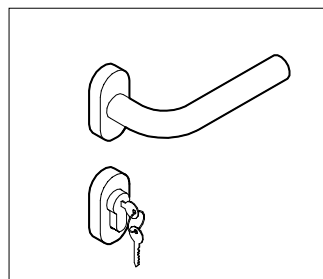

ML6

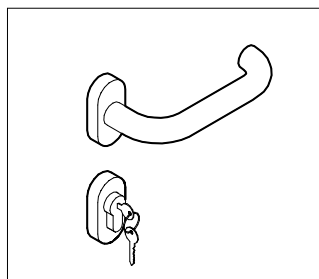

ML7

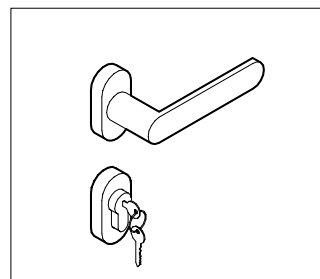

ML8

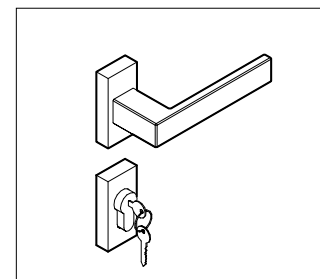

ML9

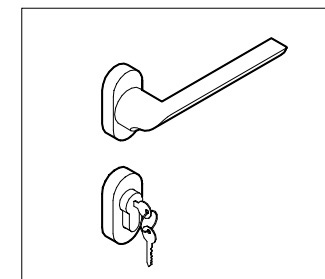

ML11

# ANTA INTELAIATA CIECA sp. 104 mm

Porta complanare

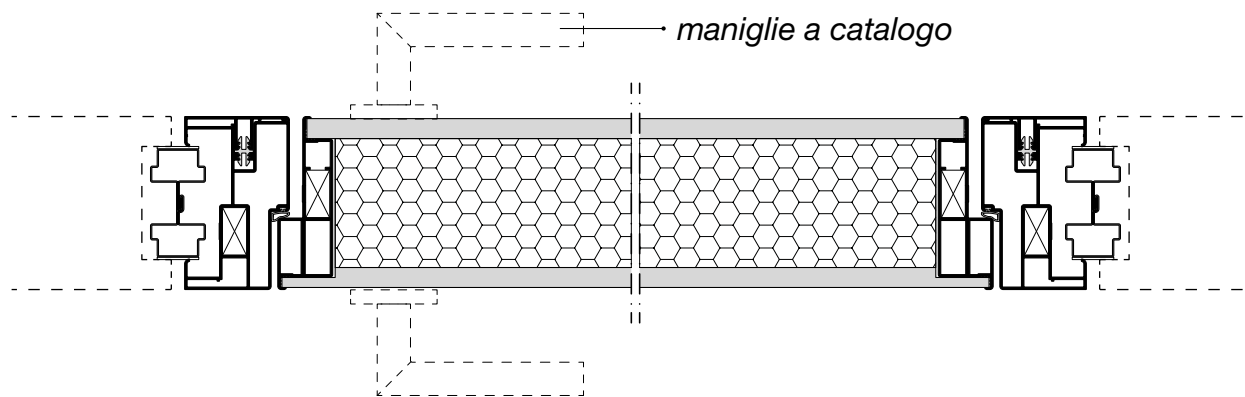
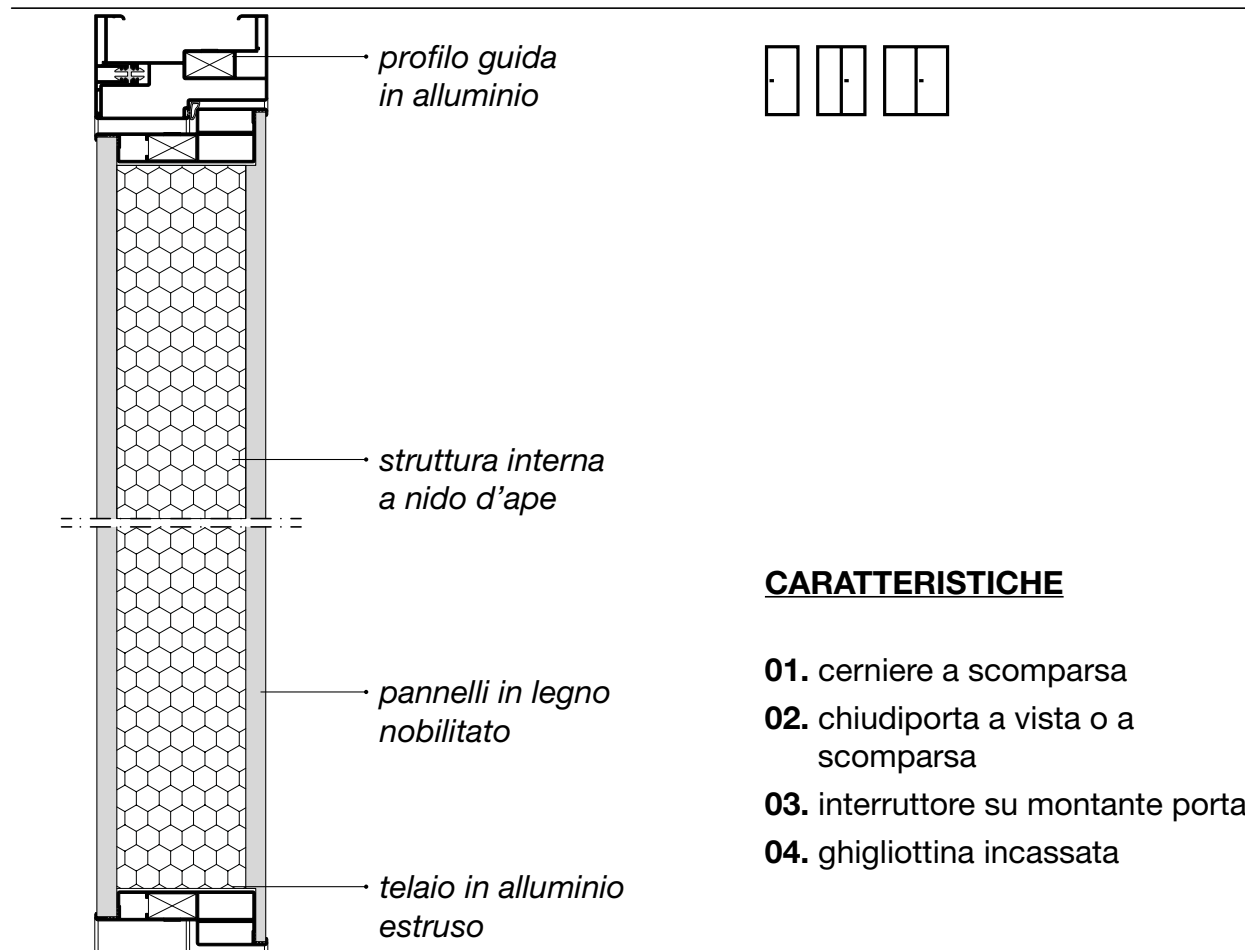

# ANTA INTELAIATA CIECA sp. 104 mm

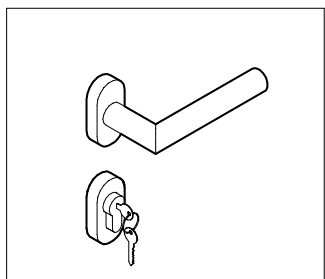

**ML5**

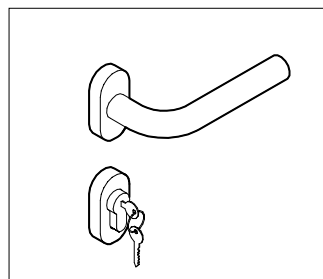

**ML6**

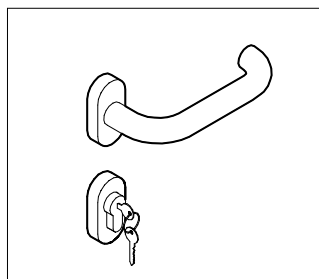

**ML7**

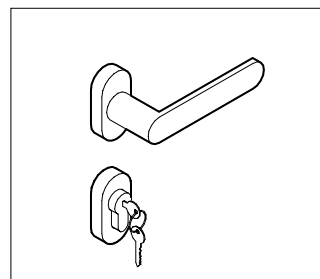

**ML8**

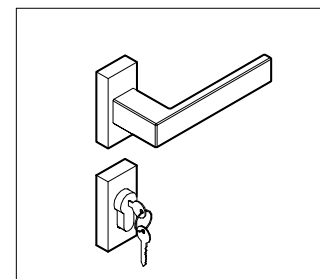

**ML9**

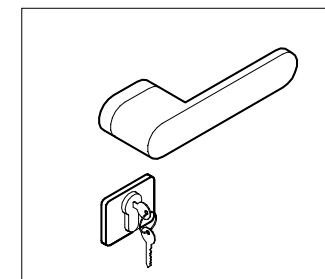

**ML10**

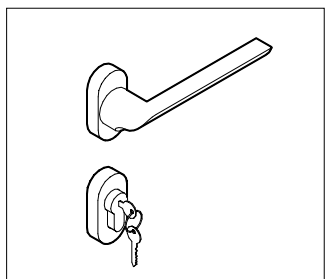

**ML11**

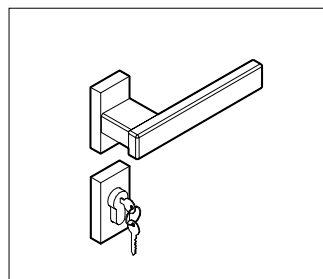

**MLQ**

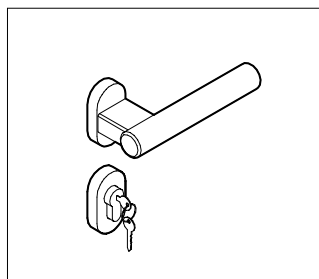

**MLT**

# ANTA INTELAIATA VETRO DOPPIO sp. 104 mm

Porta complanare

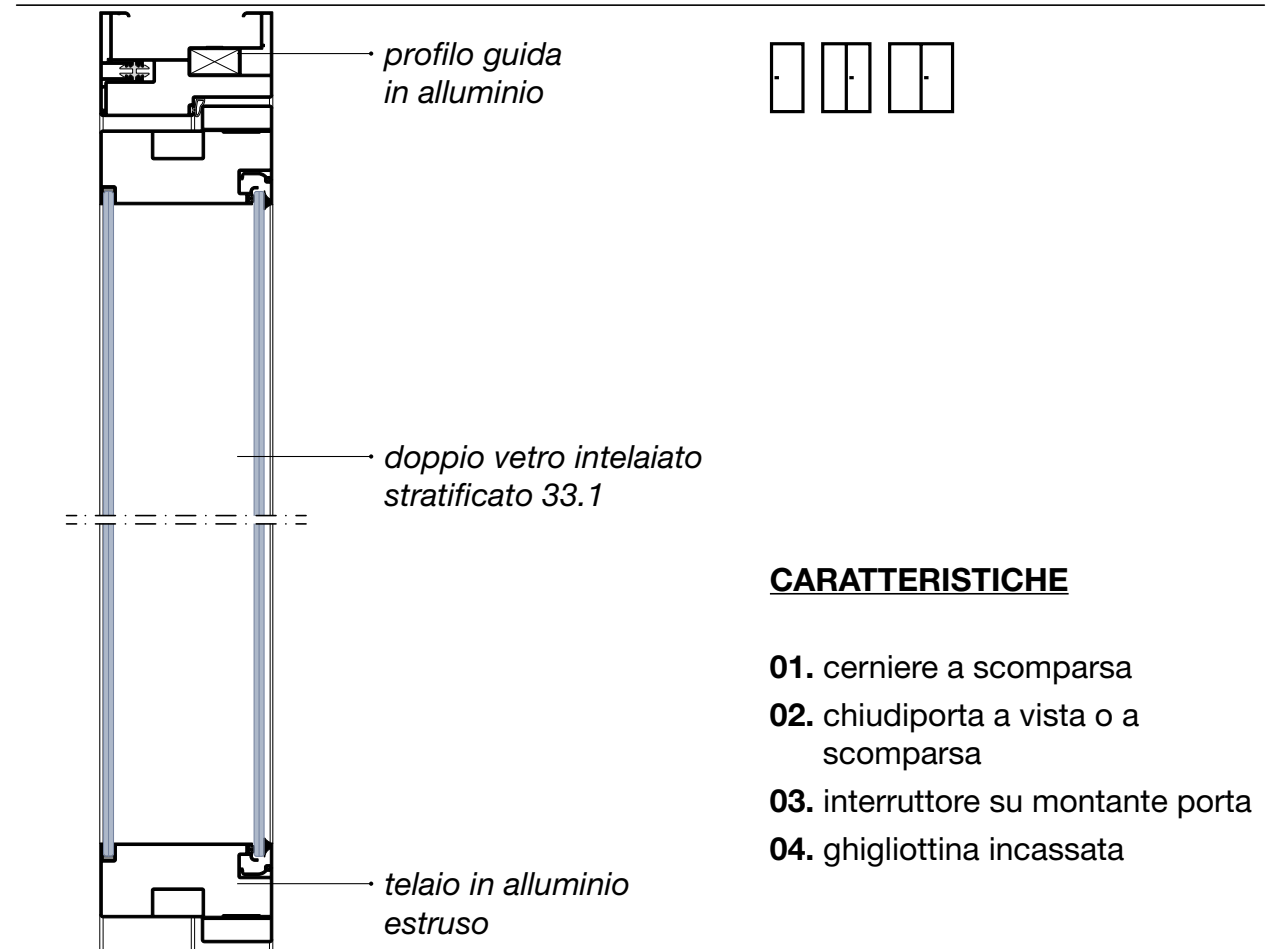

## CARATTERISTICHE

- 01. cerniere a scomparsa
- 02. chiudiporta a vista o a scomparsa
- 03. interruttore su montante porta
- 04. ghigliottina incassata

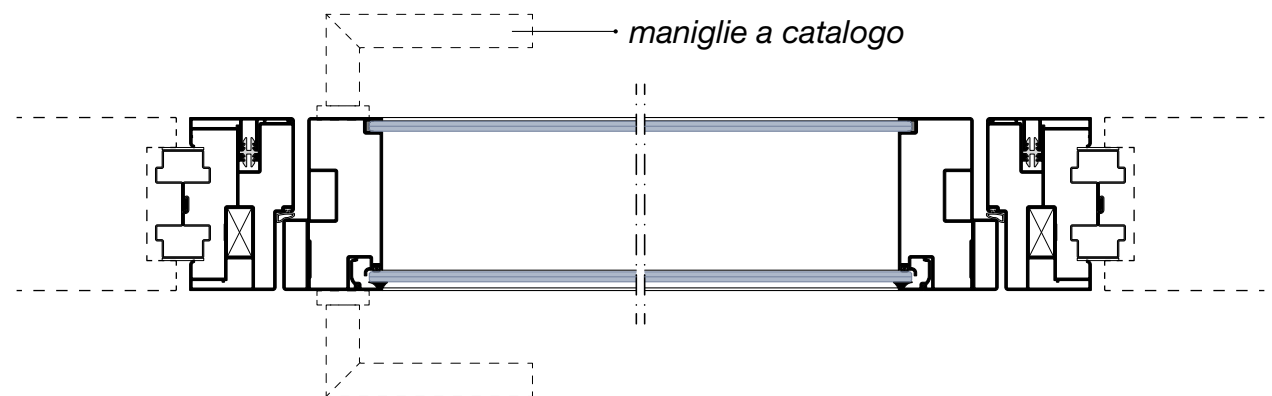



# ANTA INTELAIATA VETRO DOPPIO sp. 104 mm

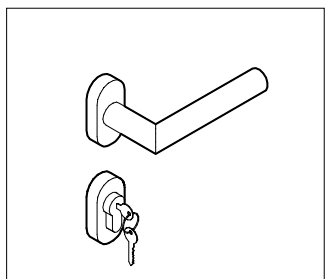

**ML5**

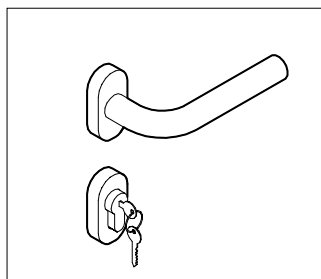

**ML6**

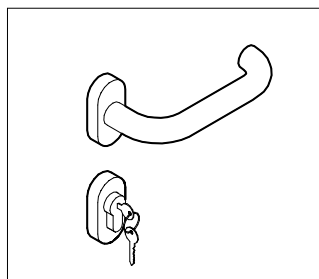

**ML7**

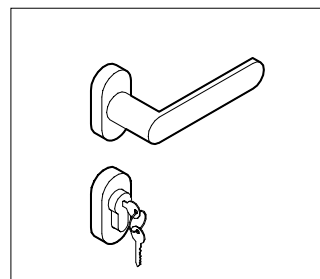

**ML8**

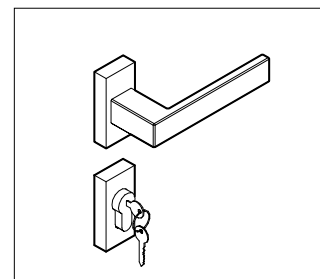

**ML9**

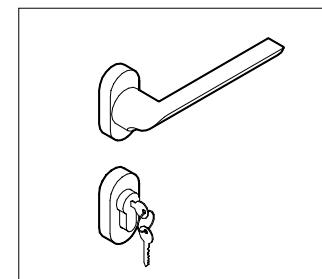

**ML11**

# TELAI PORTE SCORREVOLI



Telaio porta **Metrica Strutturale** su **Metrica D1**

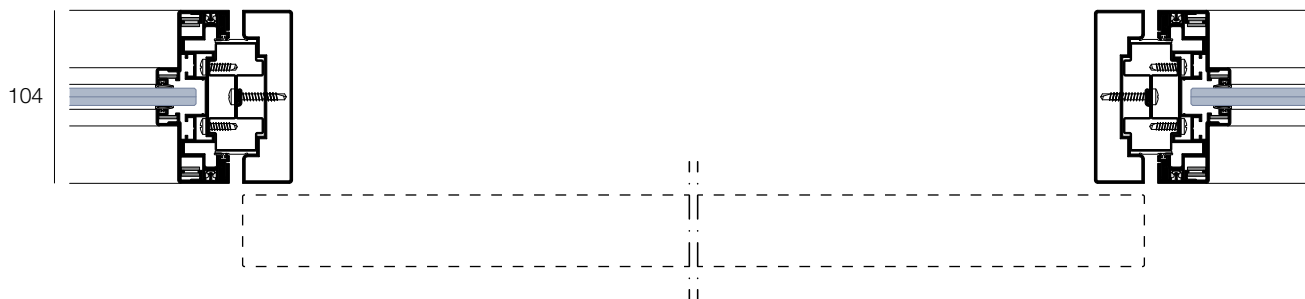

Telaio porta **Metrica Strutturale** su **Metrica D2**

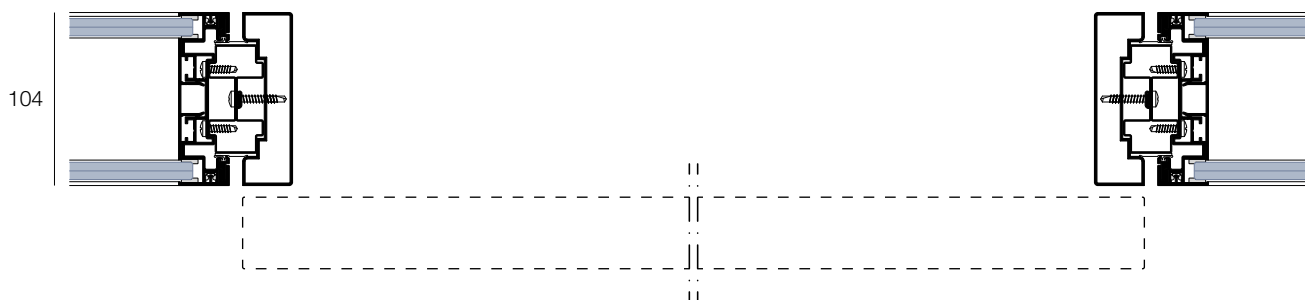

Telaio porta **Metrica Strutturale** su **Metrica Solid**

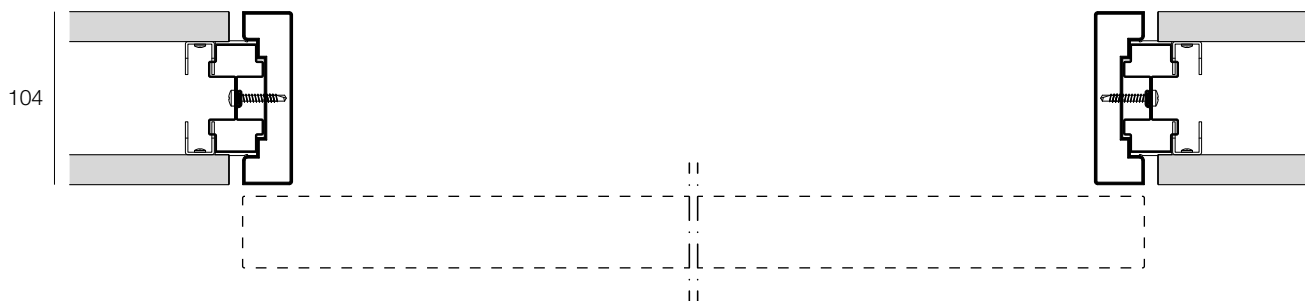

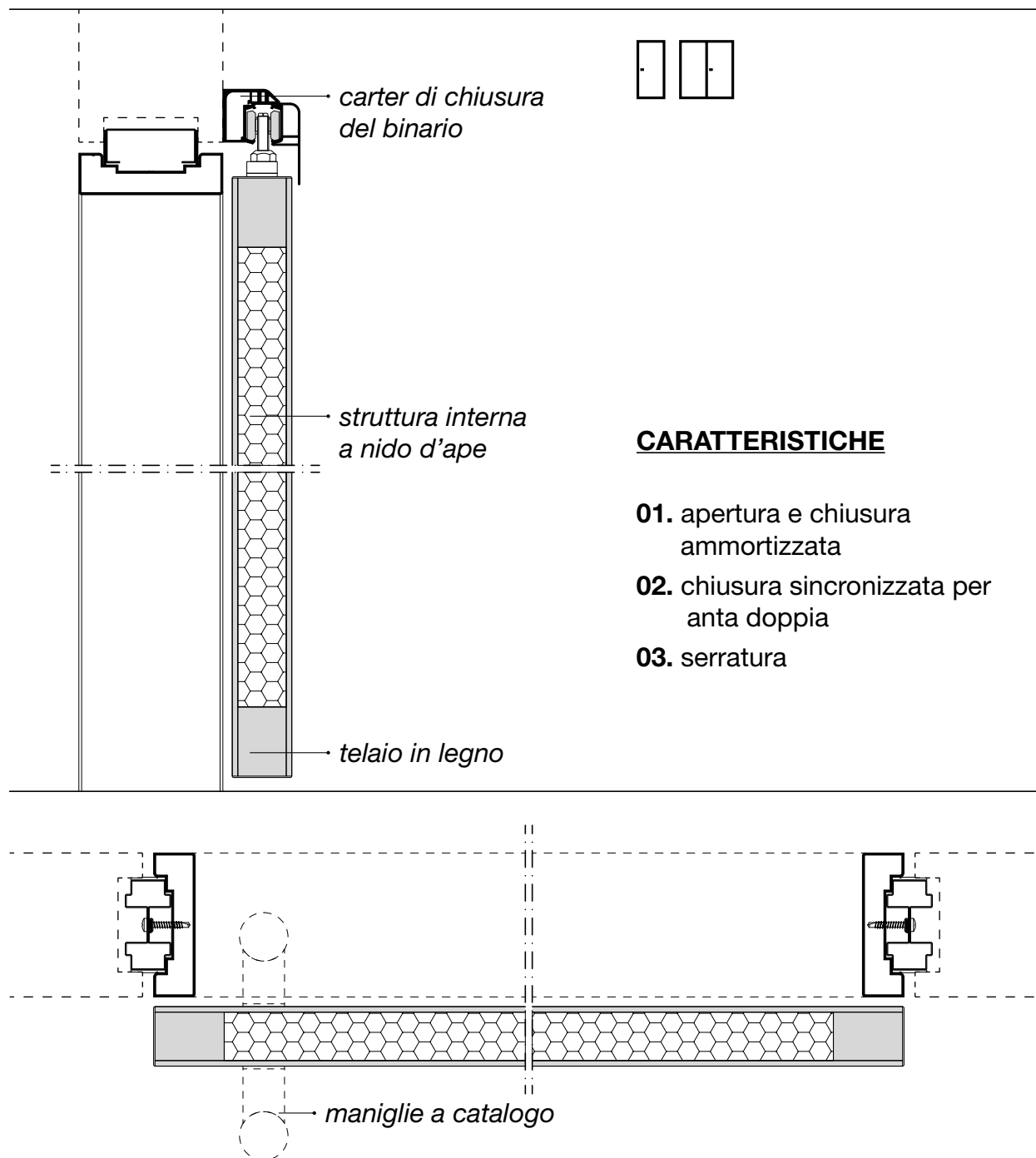

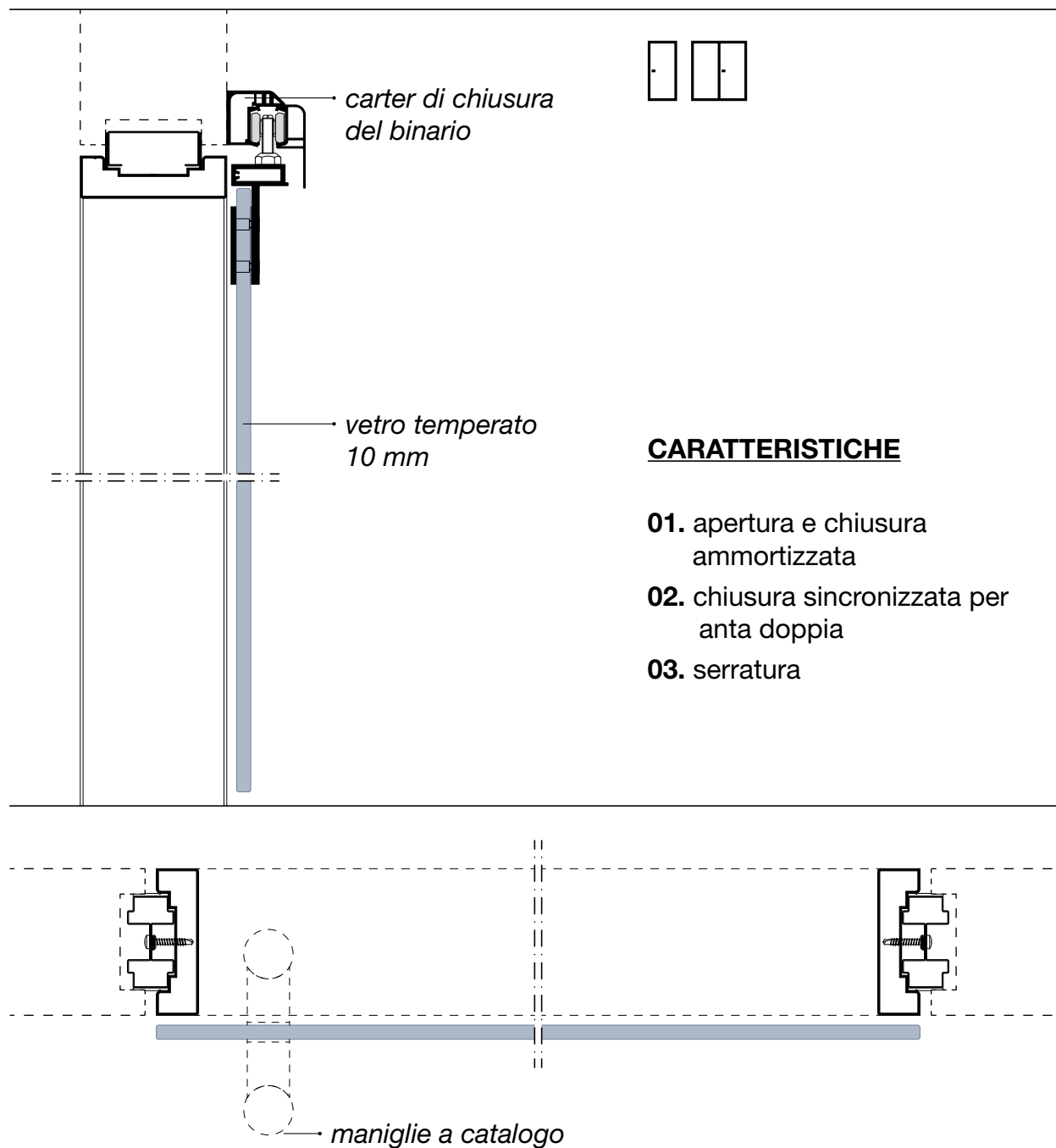

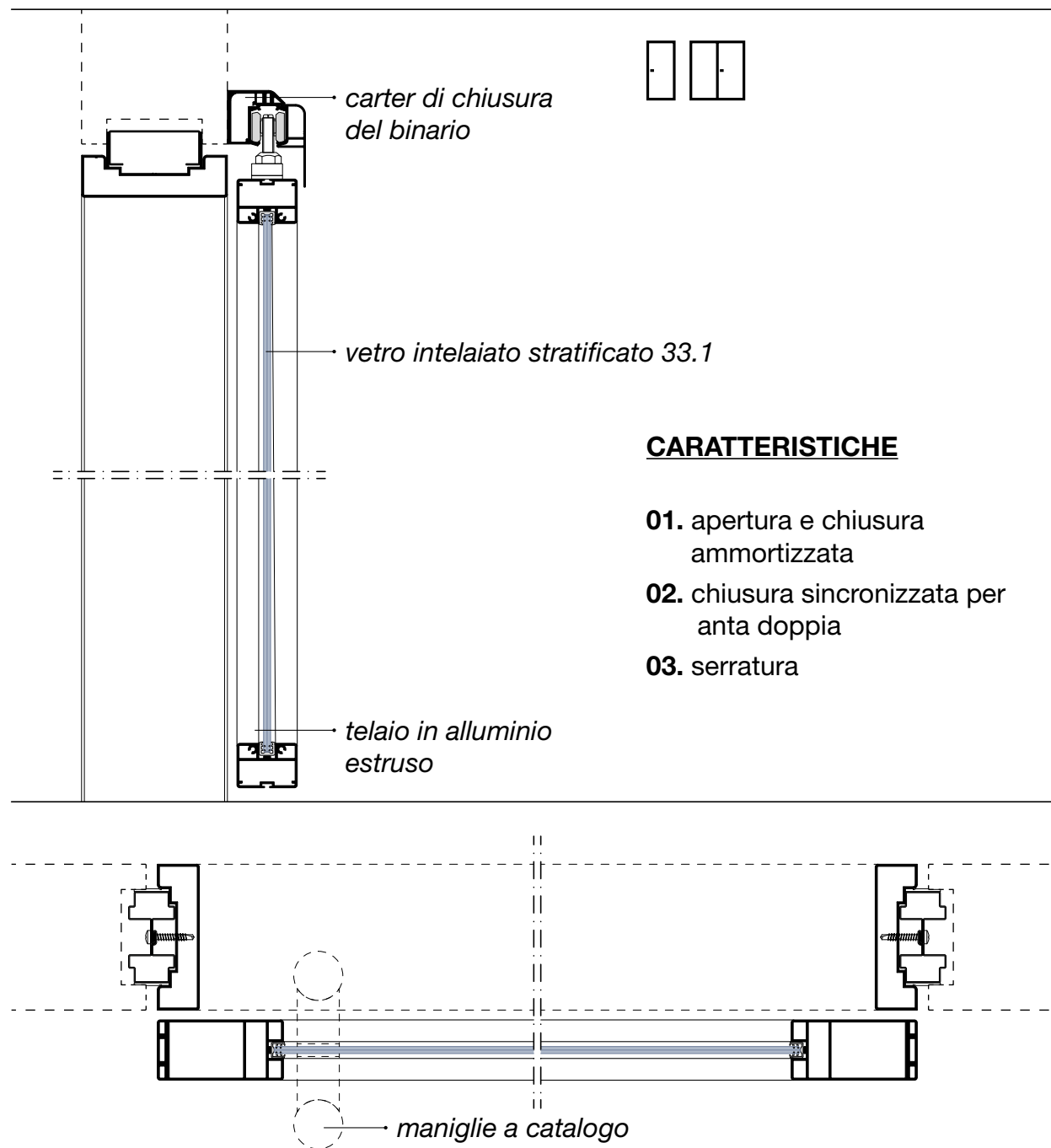

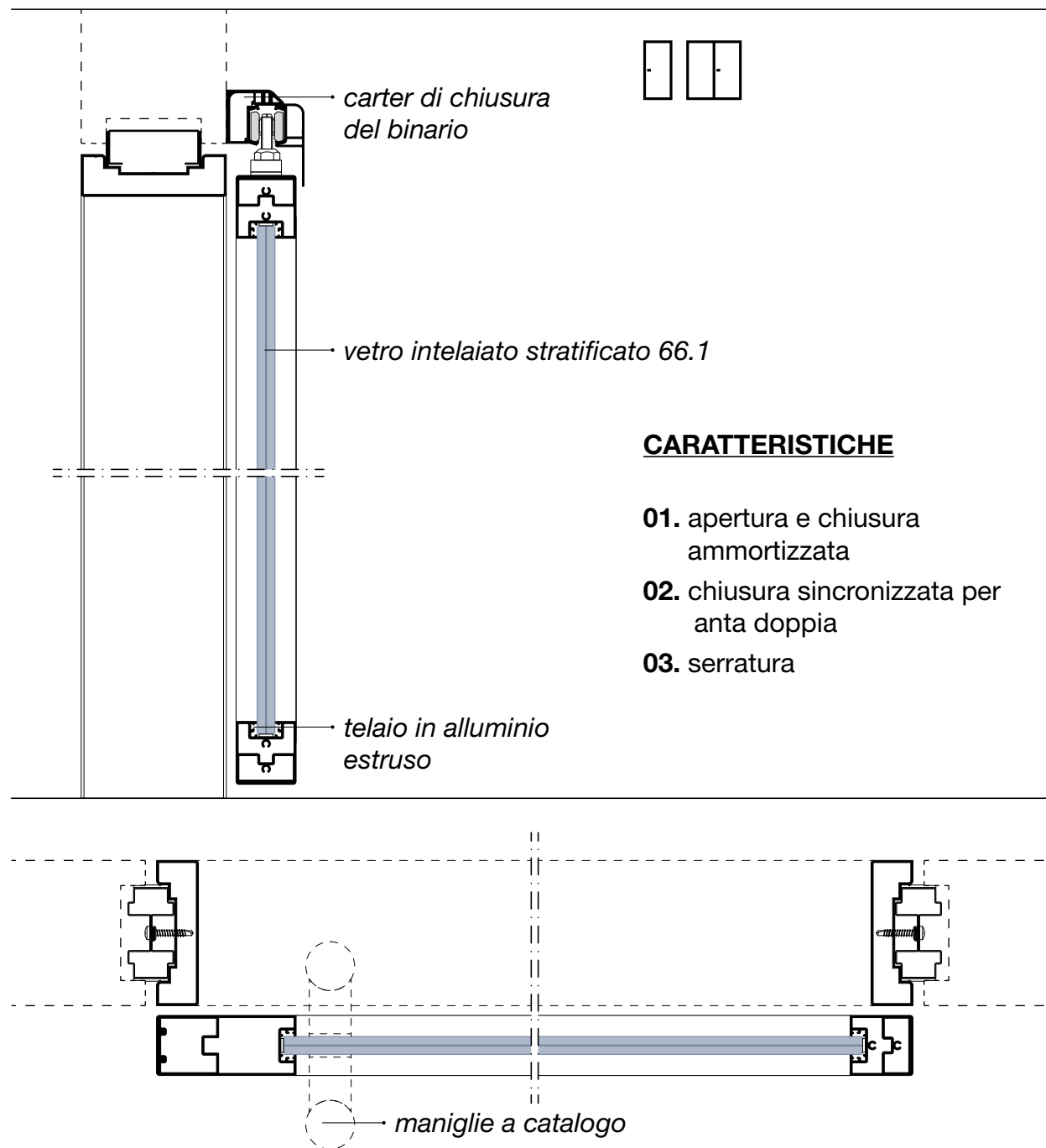

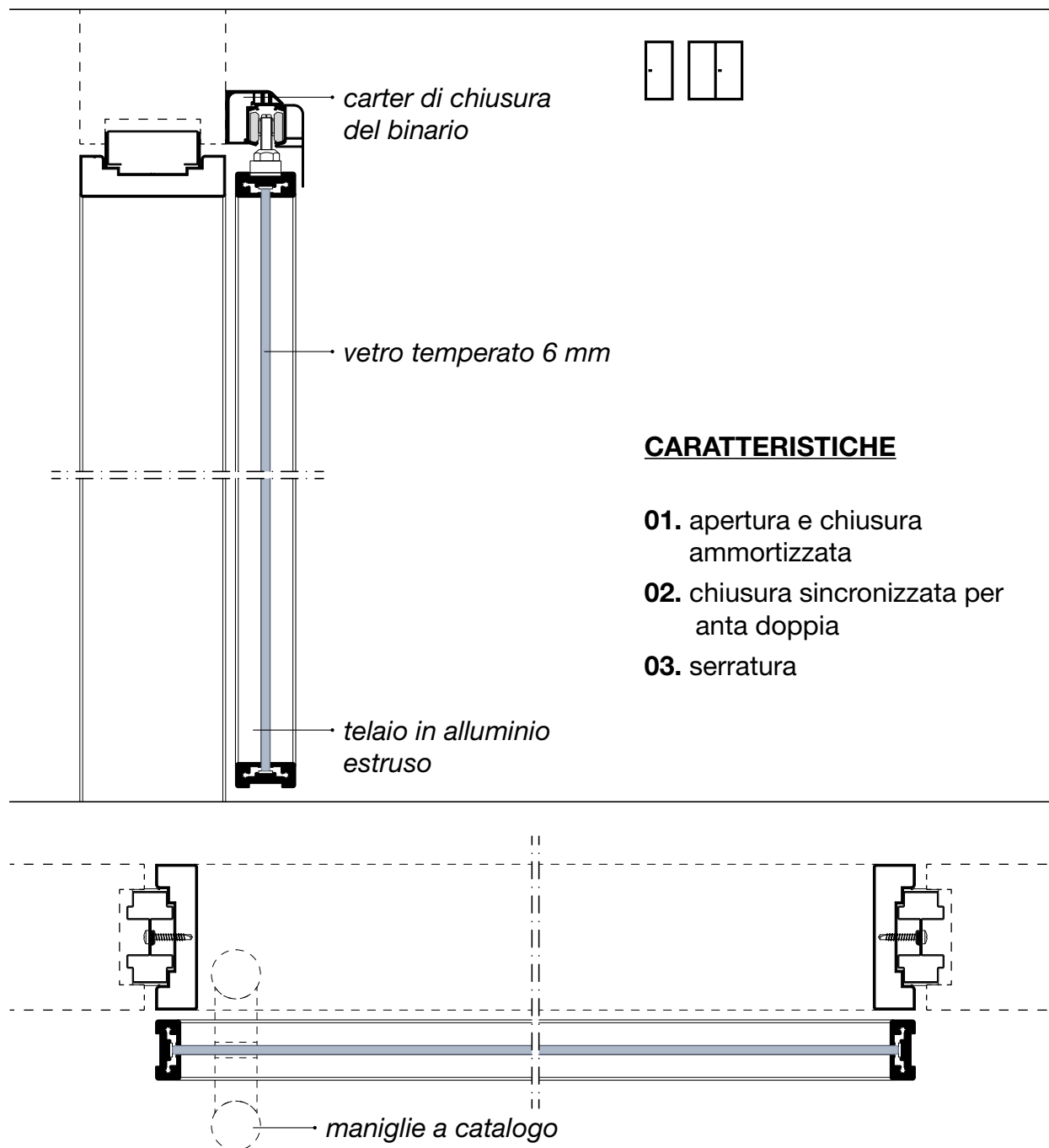

# ANTA CIECA\_SCORREVOLE INTERNA sp. 38 mm

\*solo per Metrica Solid

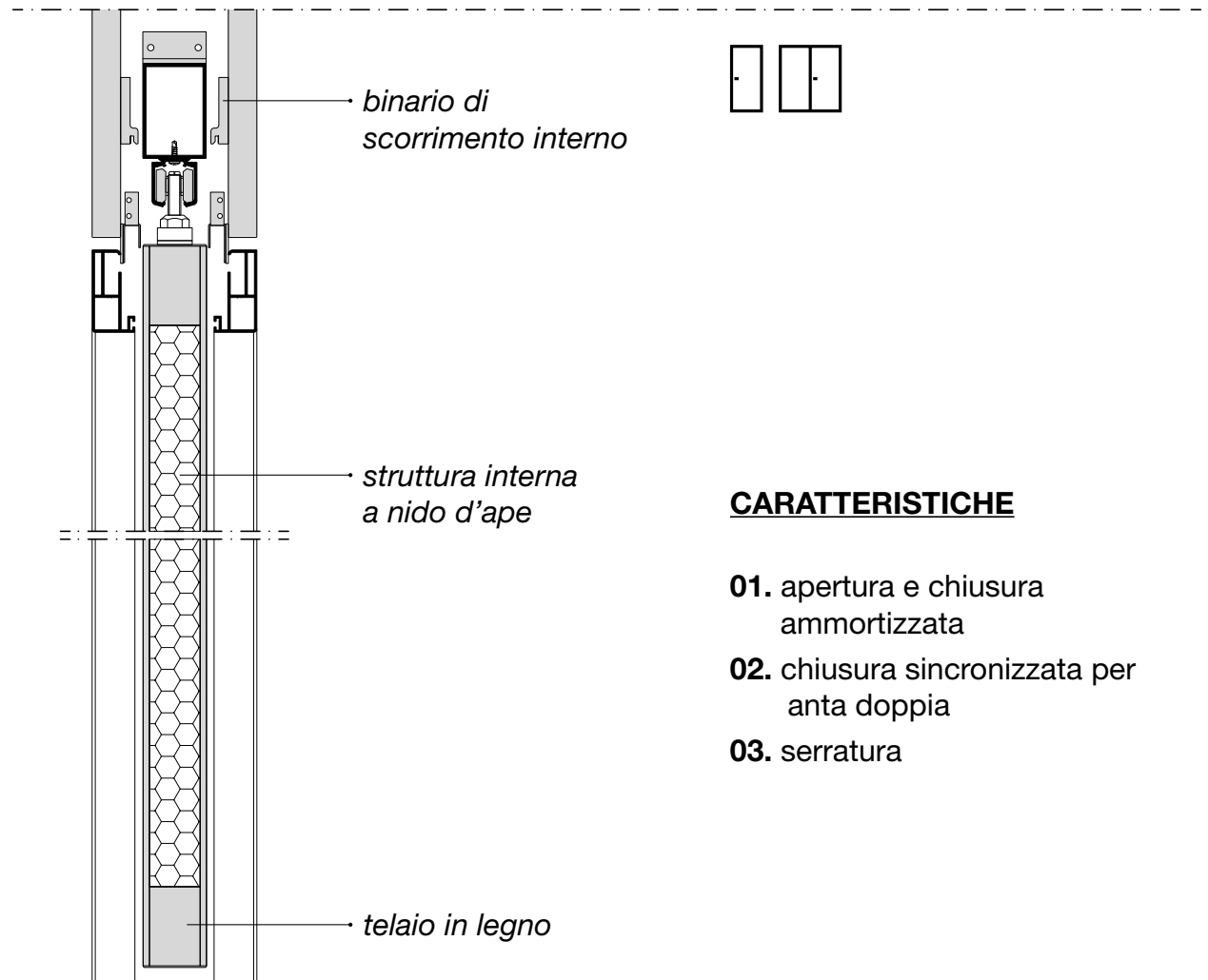

## **CARATTERISTICHE**

- 01.** apertura e chiusura ammortizzata
- 02.** chiusura sincronizzata per anta doppia
- 03.** serratura

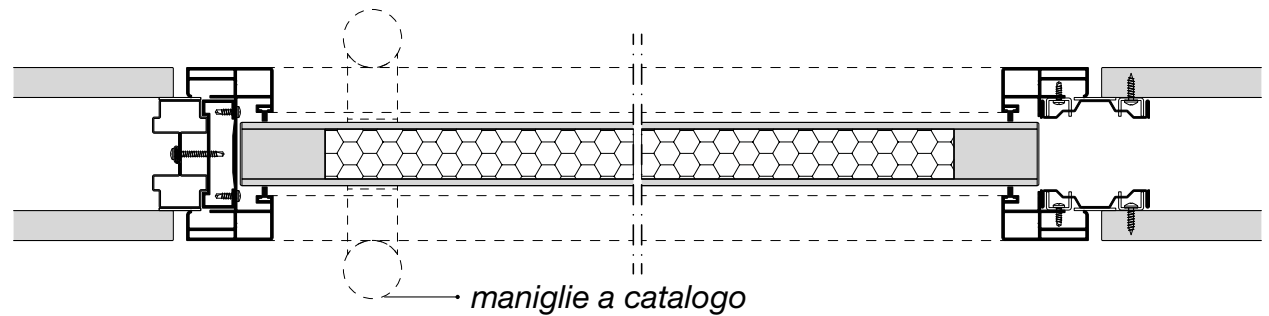



# ANTA VETRO TEMPERATO\_SCORREVOLE INTERNA sp. 10 mm

\*solo per Metrica Solid

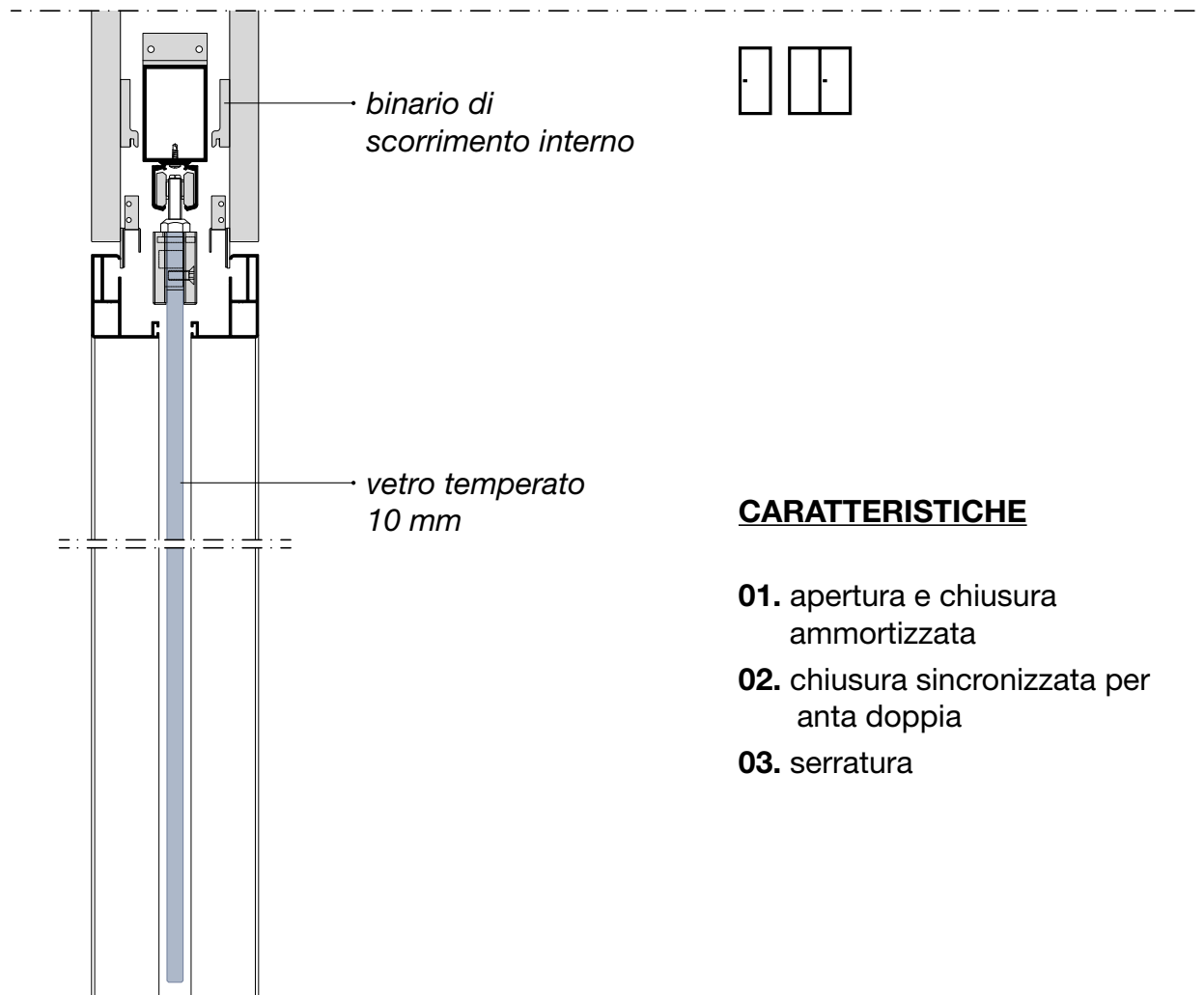
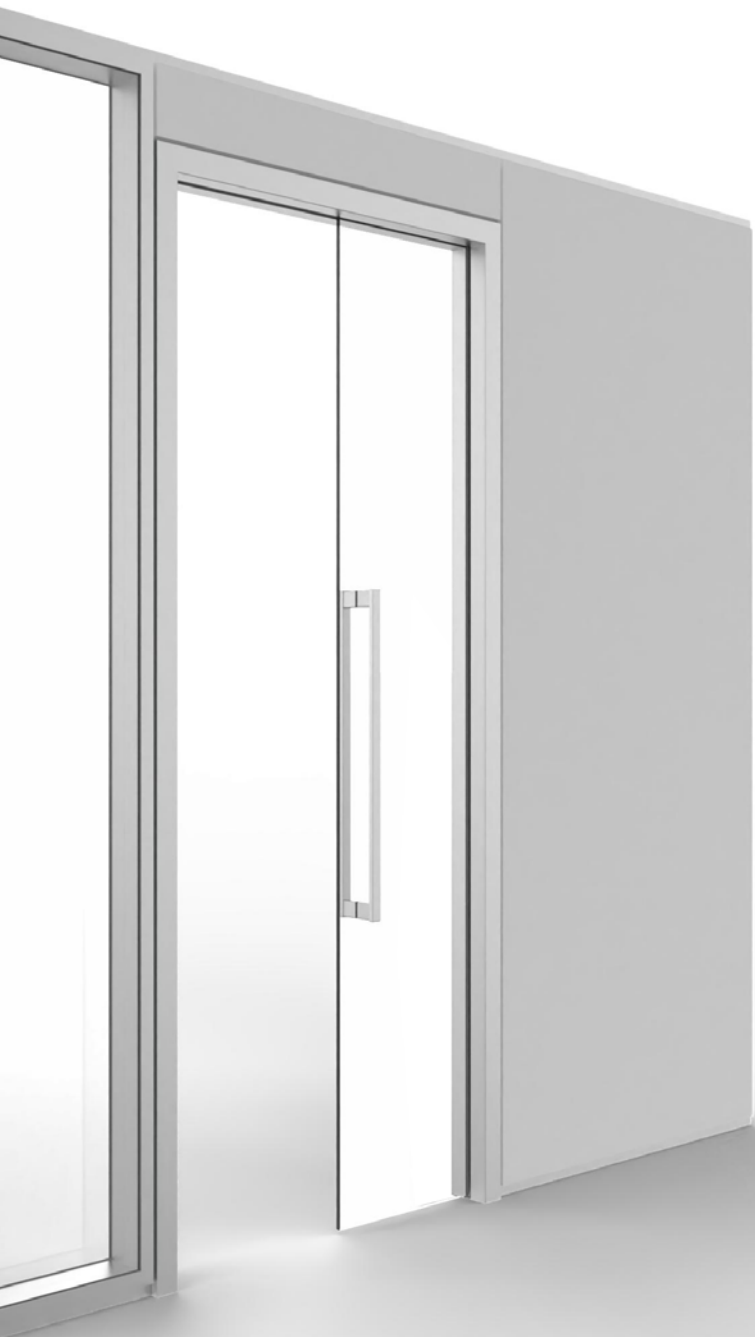

## **CARATTERISTICHE**

- 01.** apertura e chiusura ammortizzata
- 02.** chiusura sincronizzata per anta doppia
- 03.** serratura

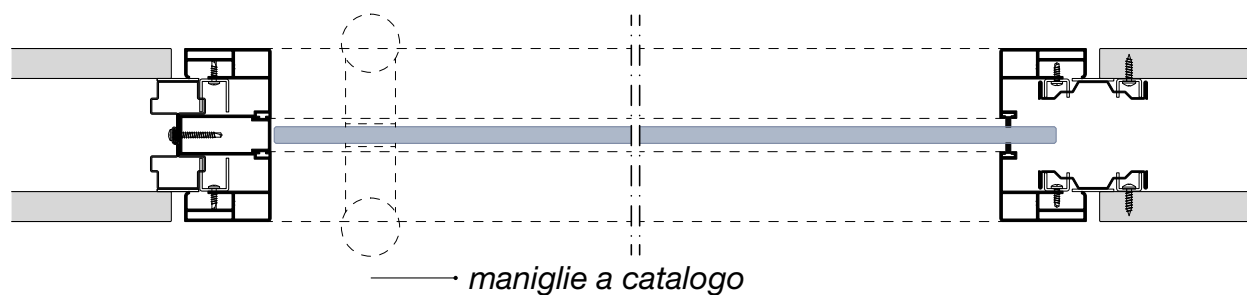

# TELAI PORTE BATTENTI

## Metrica F



Telaio porta **Metrica F** su **Metrica F1**

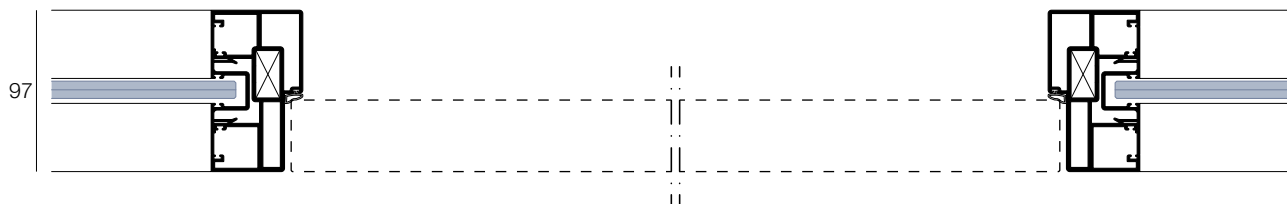

Telaio porta **Metrica F** su **Metrica FA**

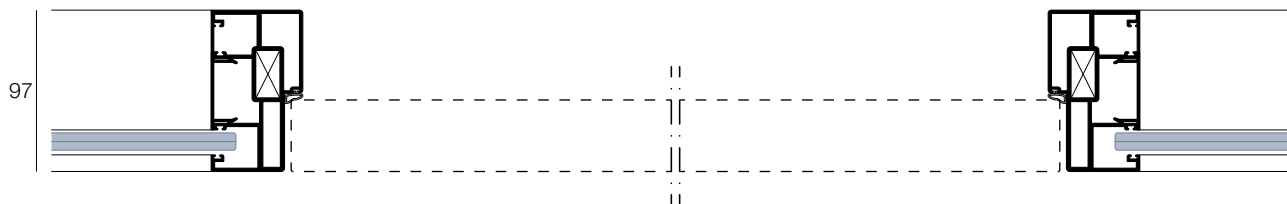

Telaio porta **Metrica F** su **Metrica F2**

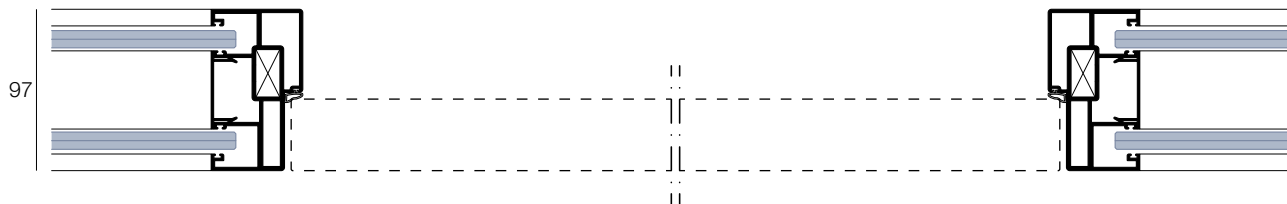

Telaio porta **Metrica F** su **Metrica F Solid**

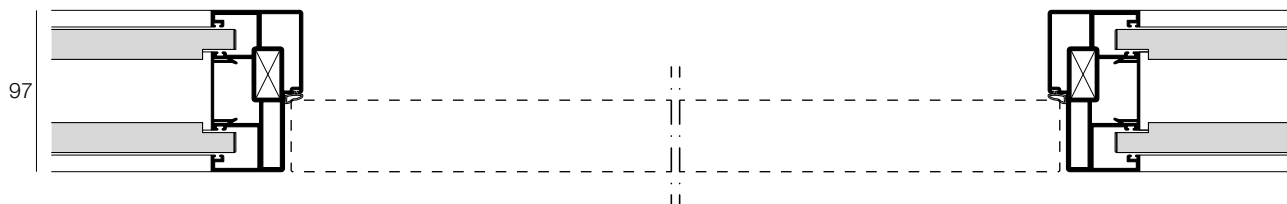

# ANTA CIECA sp. 43 mm

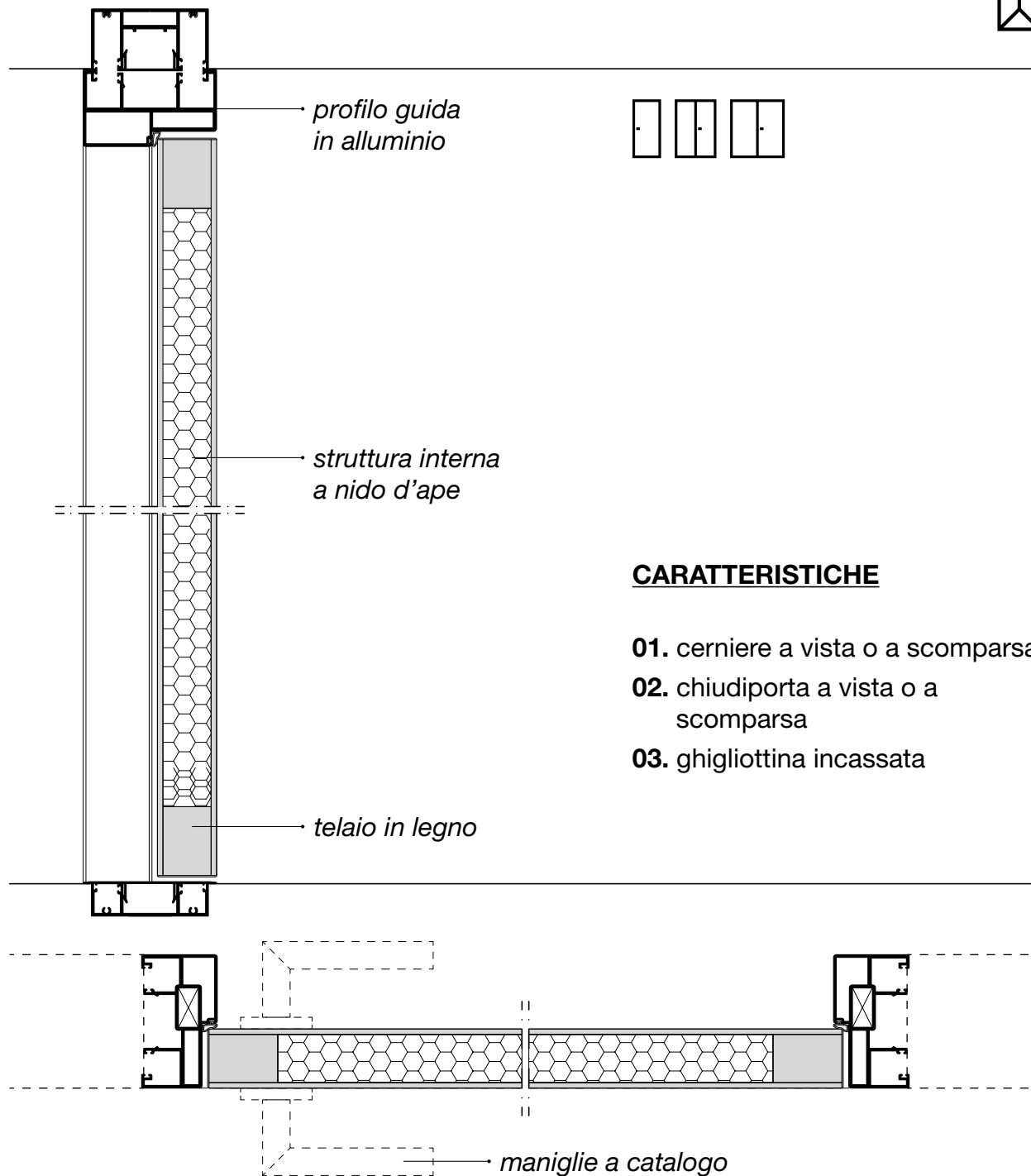

## **CARATTERISTICHE**

- 01.** cerniere a vista o a scomparsa
- 02.** chiudiporta a vista o a scomparsa
- 03.** ghigliottina incassata

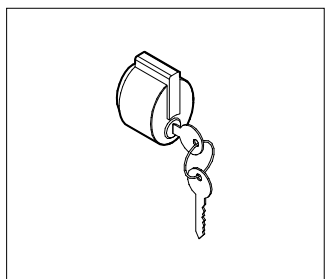

**ML1**

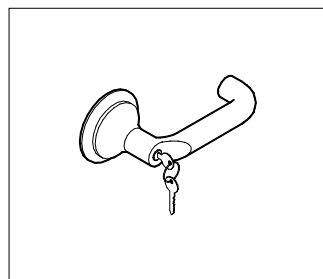

**ML4**

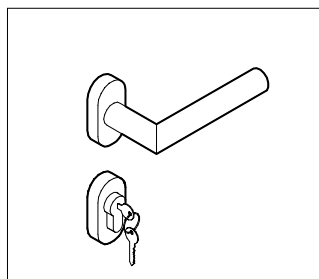

**ML5**

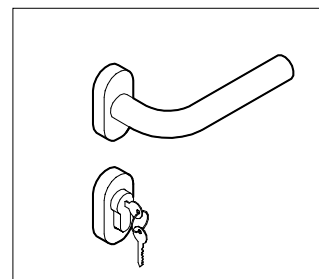

**ML6**

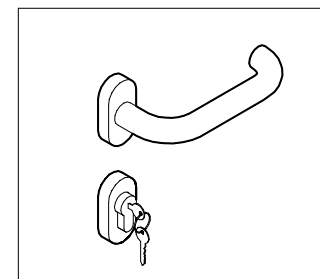

**ML7**

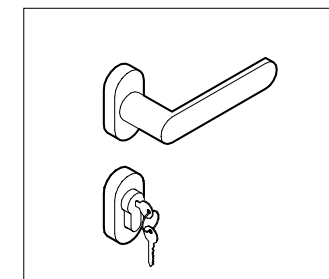

**ML8**

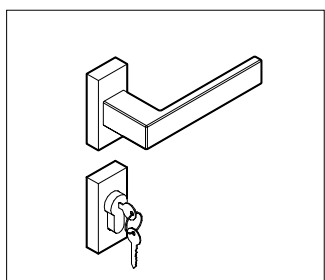

**ML9**

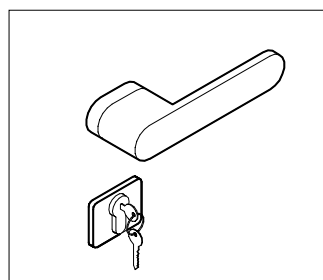

**ML10**

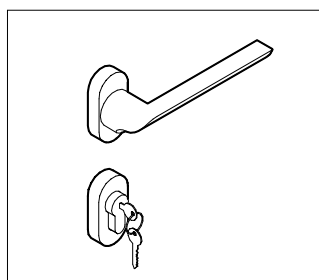

**ML11**

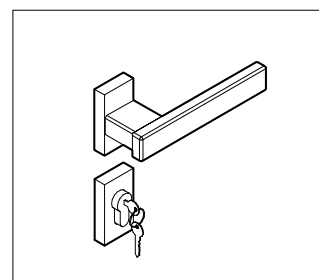

**MLQ**

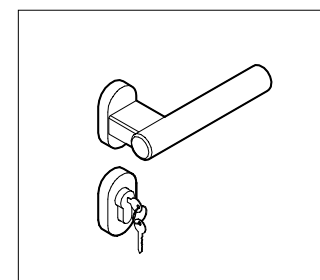

**MLT**

# ANTA VETRO TEMPERATO sp. 10 mm

Cerniere a vista

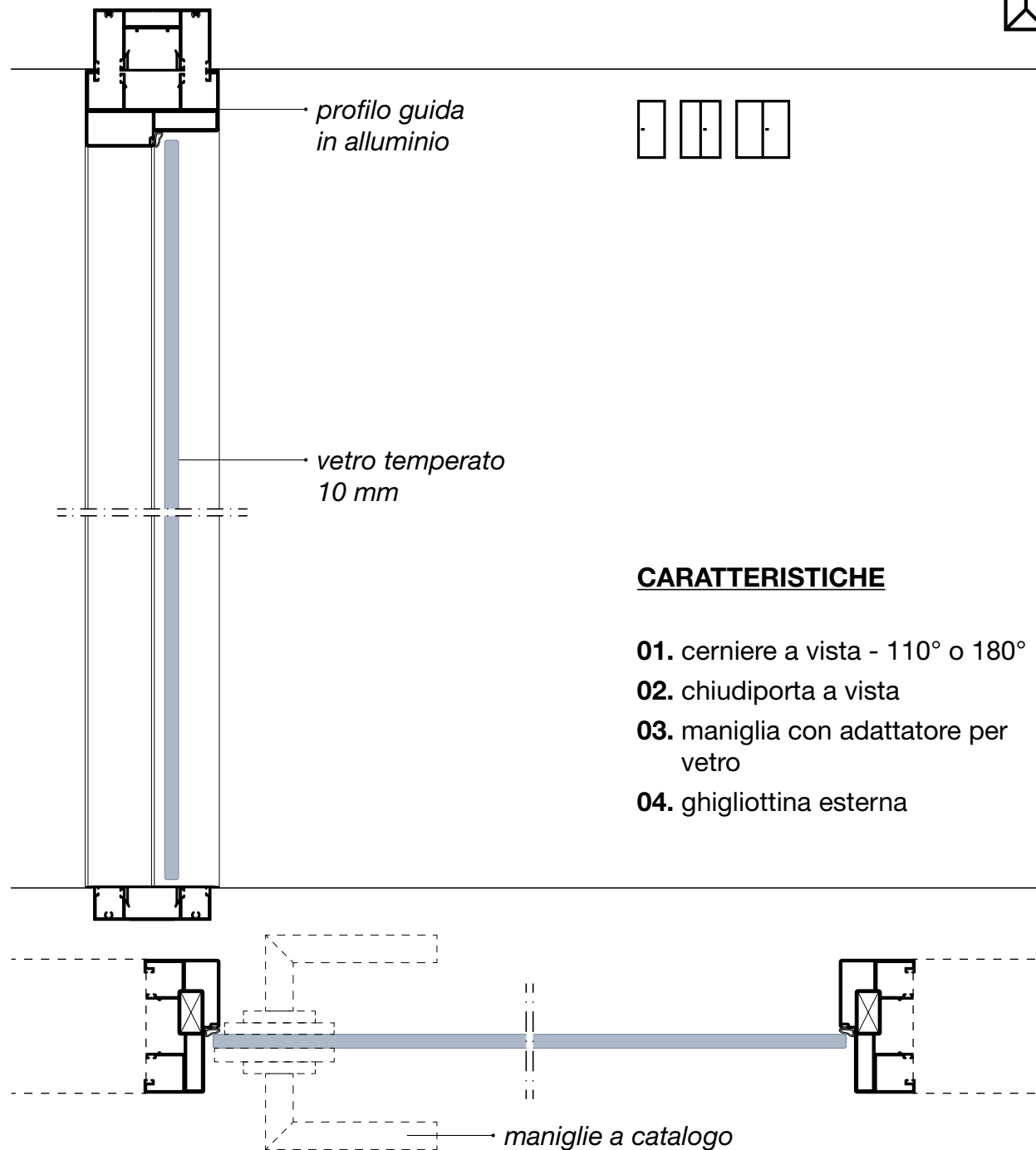

# ANTA VETRO TEMPERATO sp. 10 mm

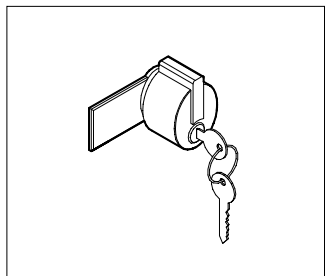

MC1

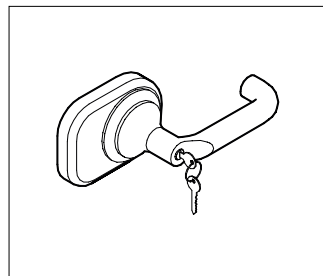

MC4

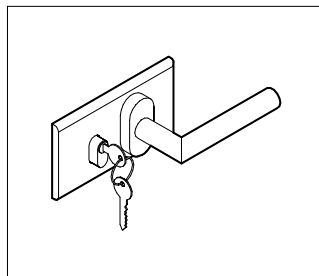

MC5

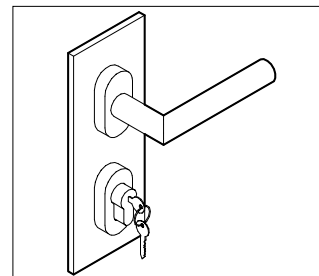

MC5V

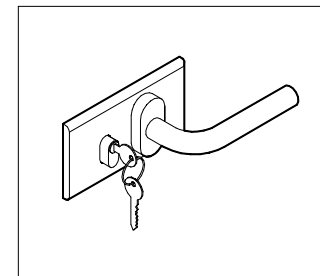

MC6

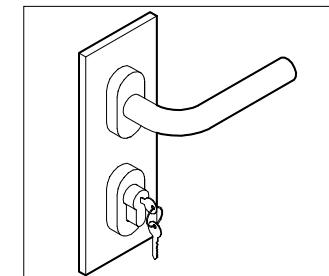

MC6V

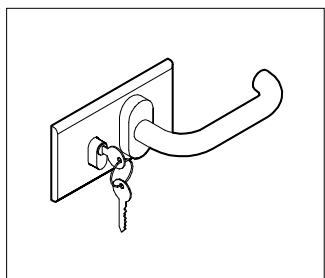

MC7

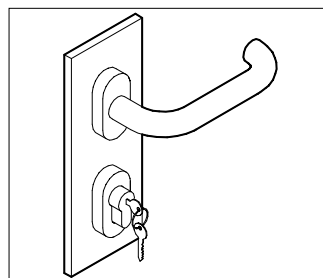

MC7V

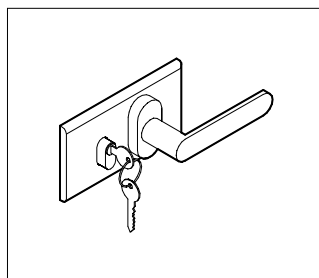

MC8

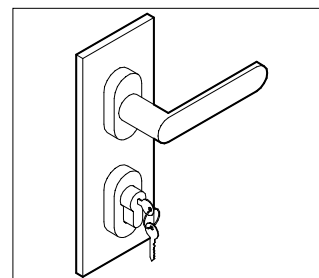

MC8V

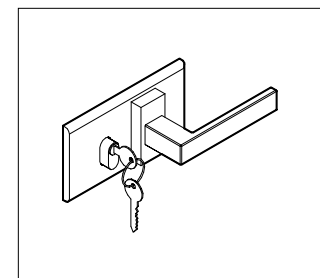

MC9

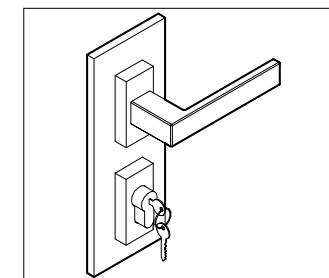

MC9V

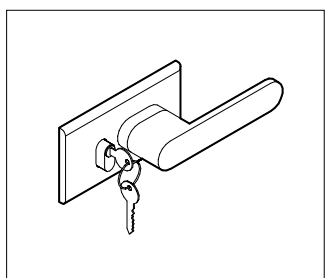

MC10

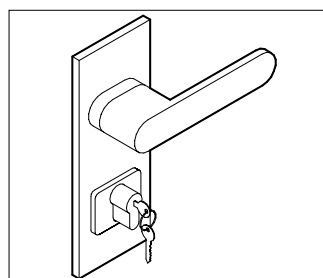

MC10V

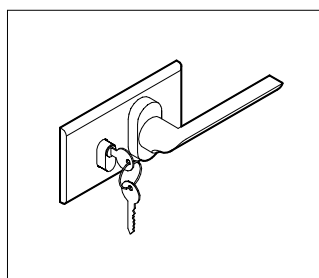

MC11

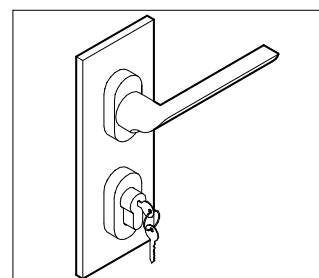

MC11V

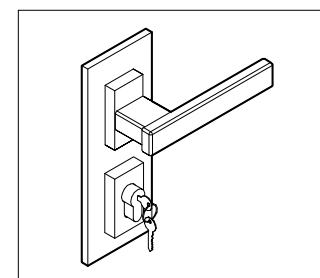

MCQ

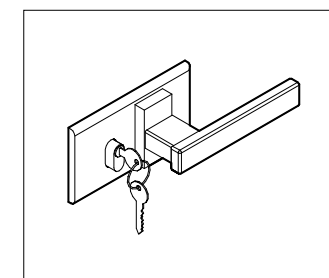

MCQO

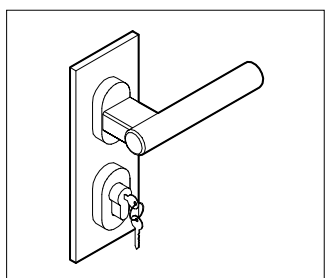

MCT

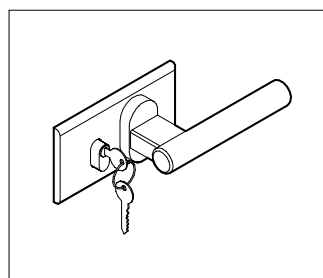

MCTO

# ANTA VETRO TEMPERATO sp. 10 mm

Cerniera continua

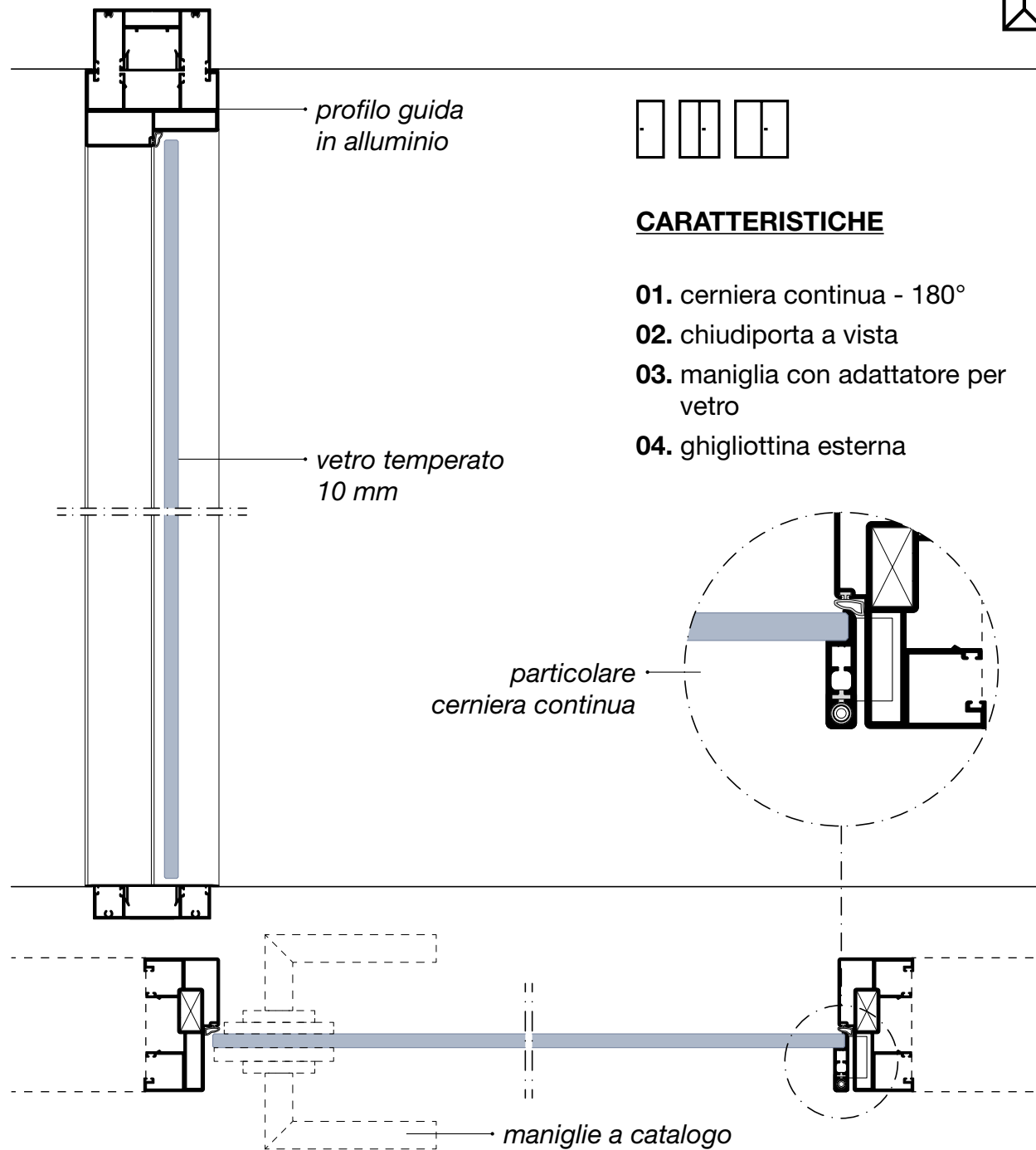
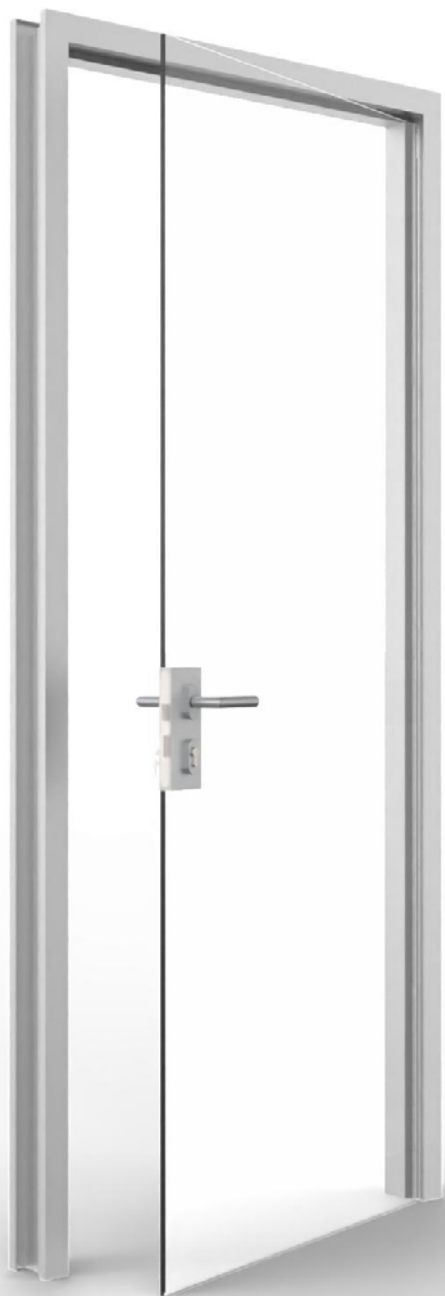

# ANTA VETRO TEMPERATO sp. 10 mm

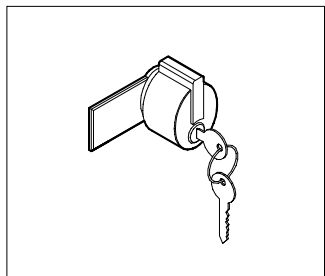

MC1

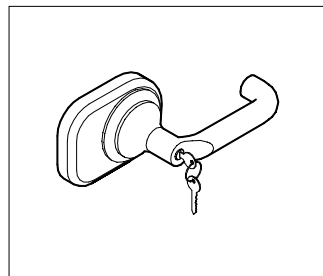

MC4

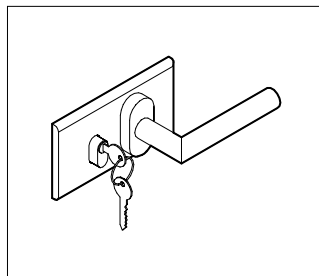

MC5

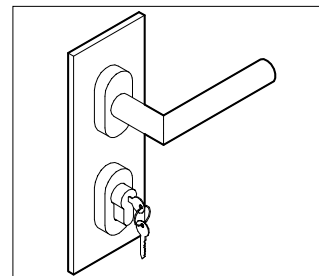

MC5V

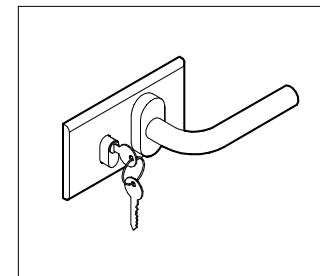

MC6

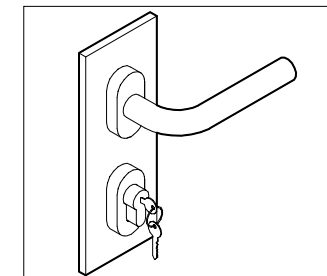

MC6V

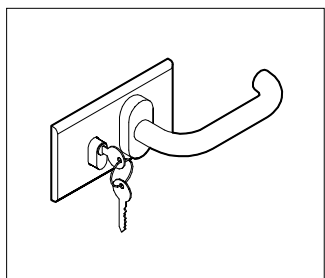

MC7

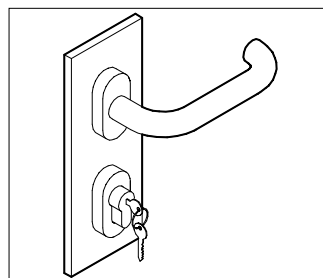

MC7V

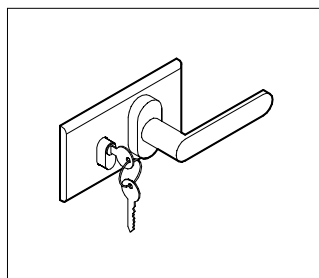

MC8

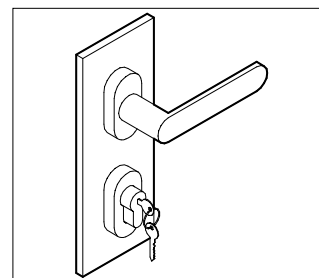

MC8V

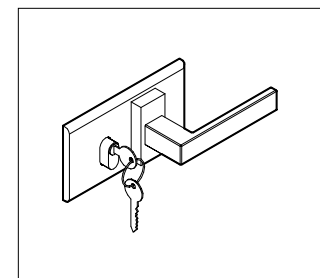

MC9

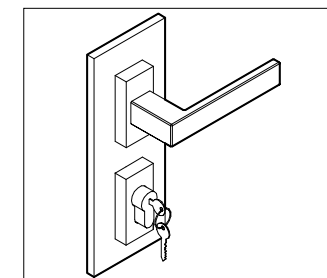

MC9V

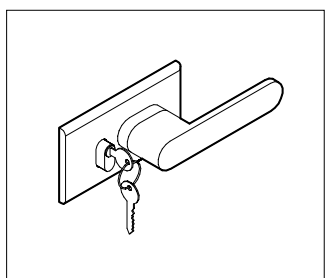

MC10

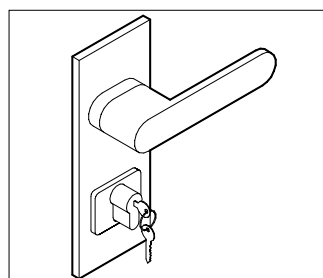

MC10V

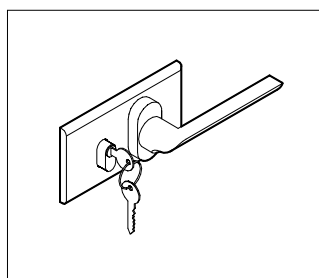

MC11

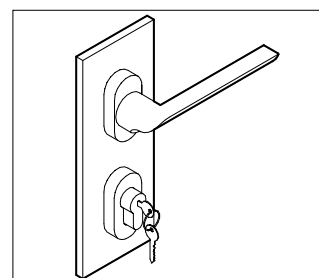

MC11V

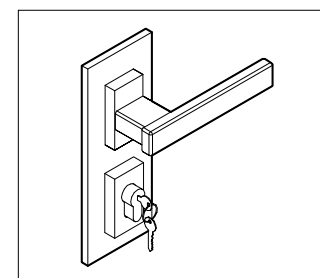

MCQ

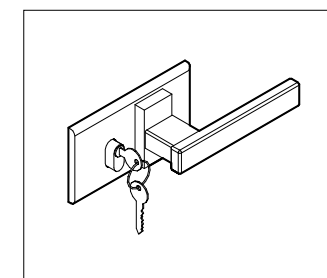

MCQO

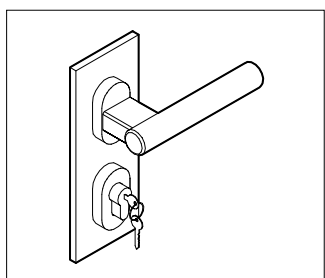

MCT

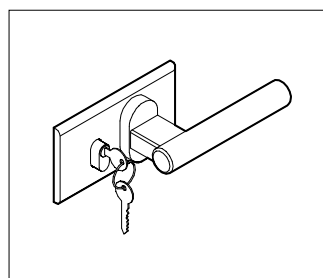

MCTO



# ANTA INTELAIATA CIECA sp. 97 mm

Porta complanare

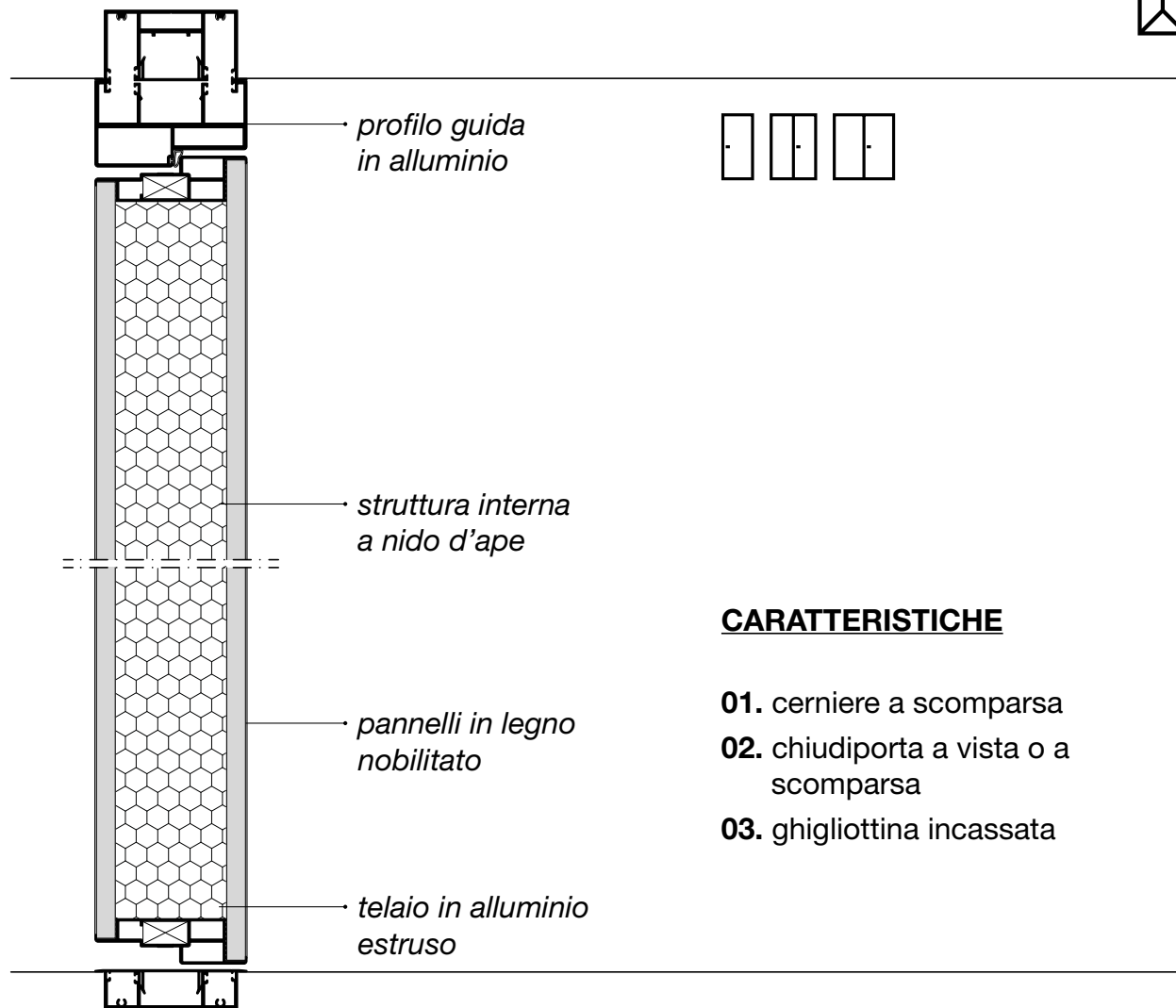

## CARATTERISTICHE

- 01.** cerniere a scomparsa
- 02.** chiudiporta a vista o a scomparsa
- 03.** ghigliottina incassata

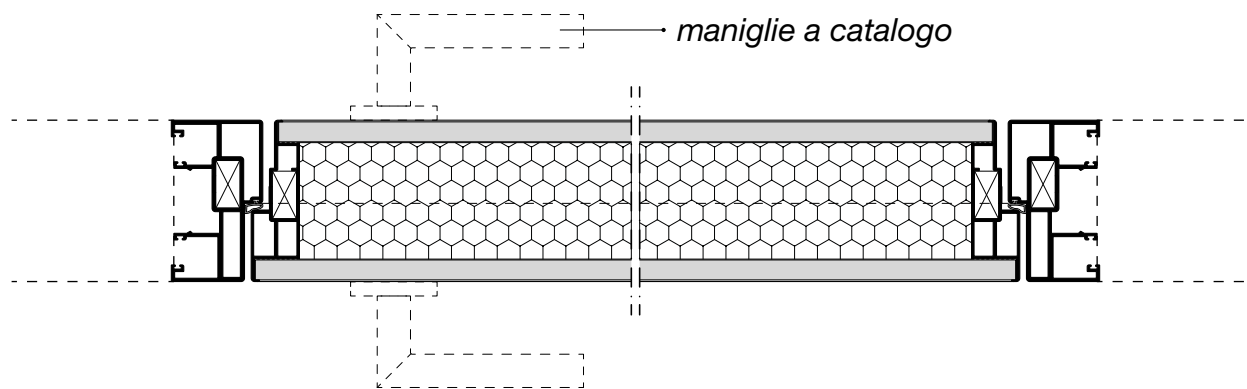

# ANTA INTELAIATA CIECA sp. 97 mm

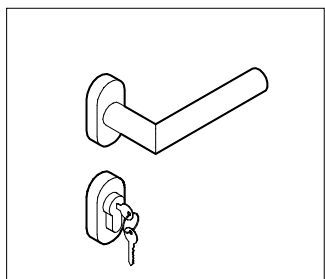

**ML5**

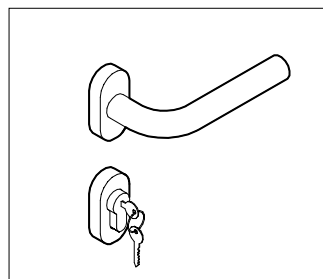

**ML6**

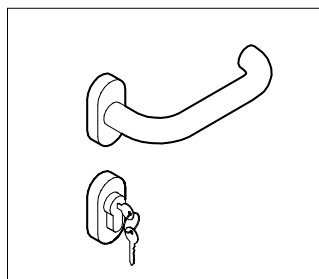

**ML7**

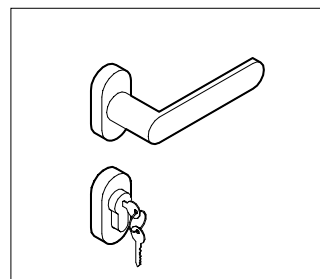

**ML8**

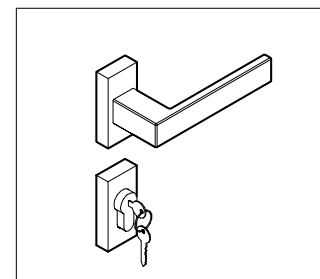

**ML9**

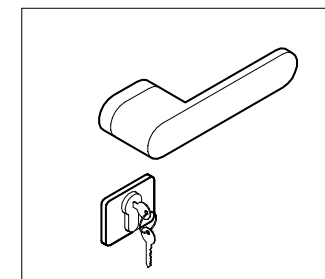

**ML10**

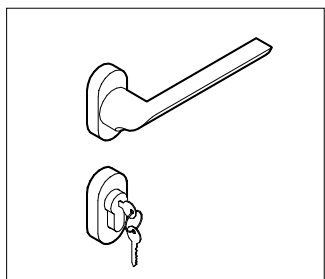

**ML11**

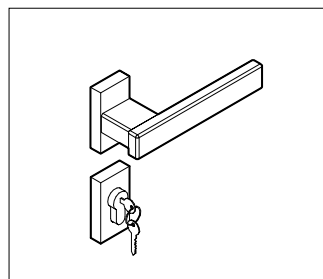

**MLQ**

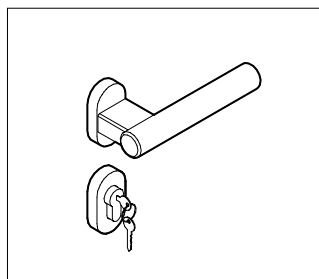

**MLT**

# ANTA INTELAIATA VETRO DOPPIO sp. 97 mm

Porta complanare

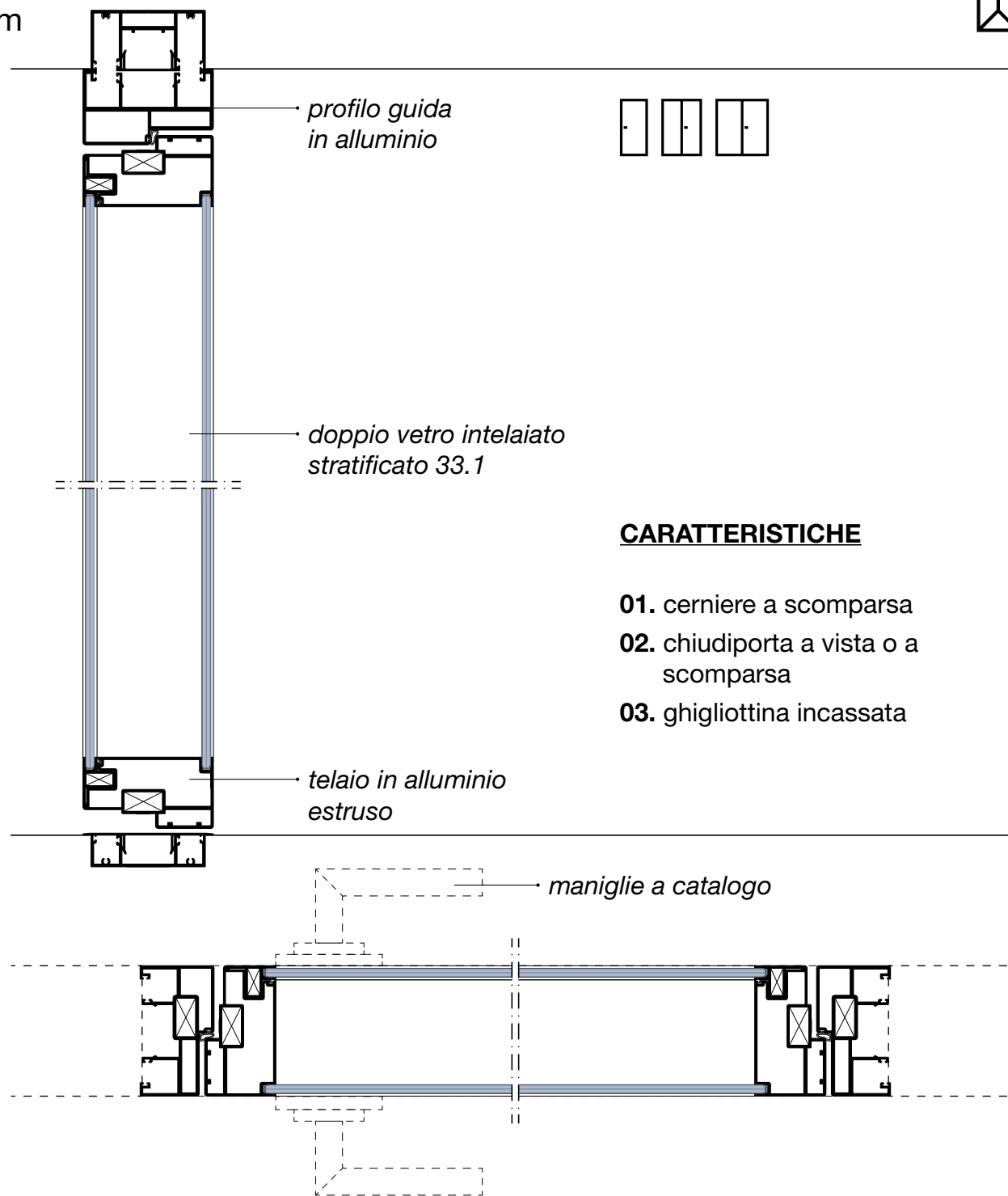

# ANTA INTELAIATA VETRO DOPPIO sp. 97 mm

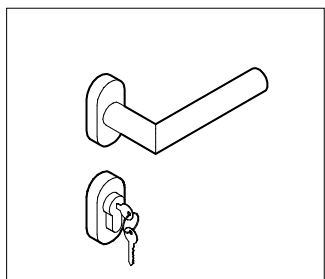

**ML5**

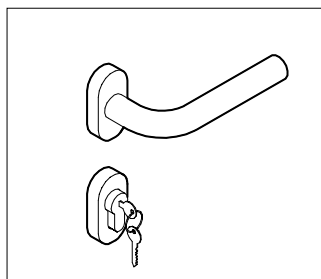

**ML6**

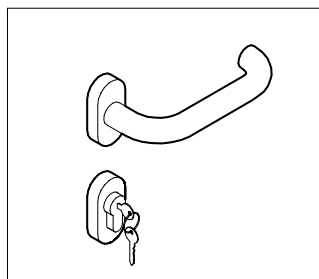

**ML7**

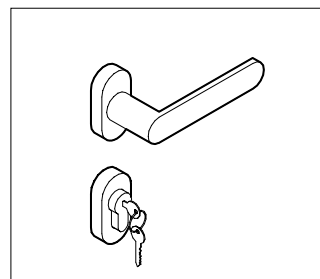

**ML8**

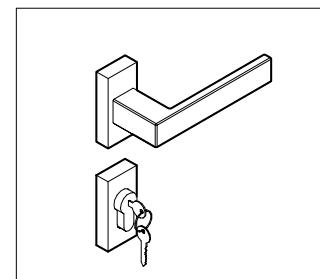

**ML9**

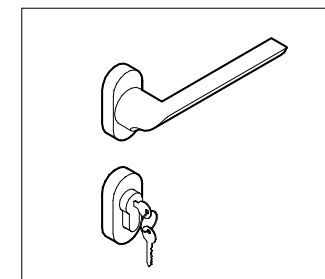

**ML11**

# ANTA INTELAIATA sp. 25 mm

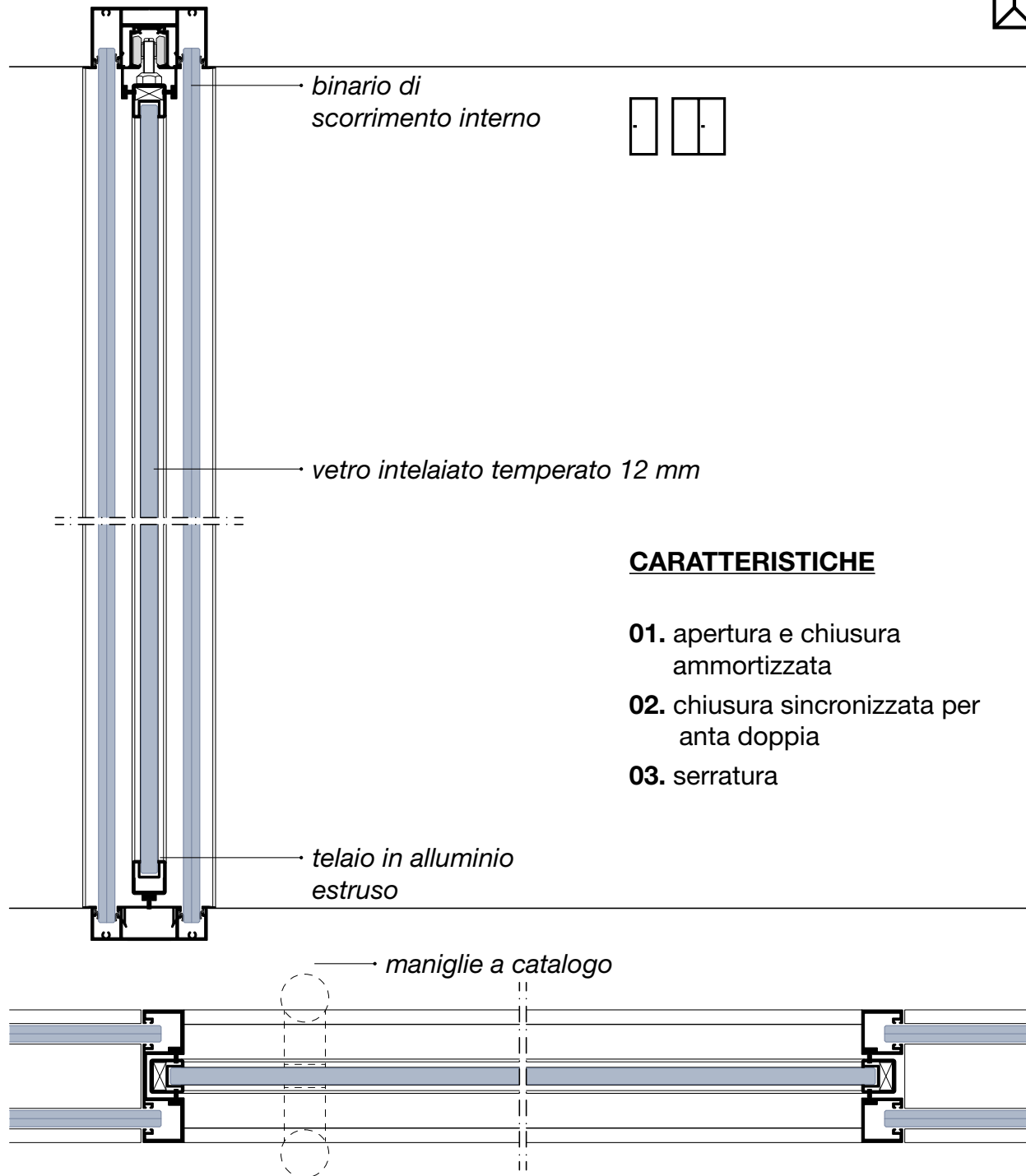

## **CARATTERISTICHE**

- 01.** apertura e chiusura ammortizzata
- 02.** chiusura sincronizzata per anta doppia
- 03.** serratura

# Porte in vetro



ACCIAIO

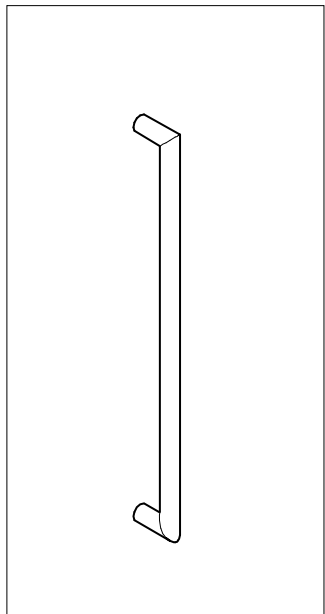

**MPOMGH1\_H2\_H3**

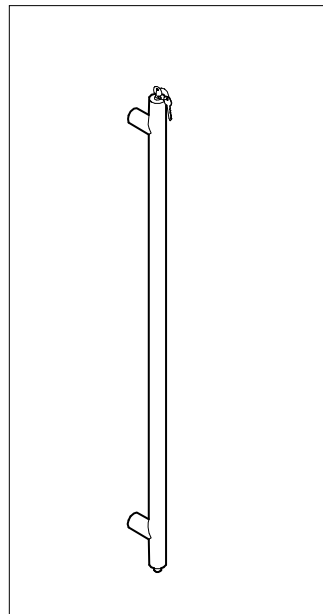

**MPOM2**

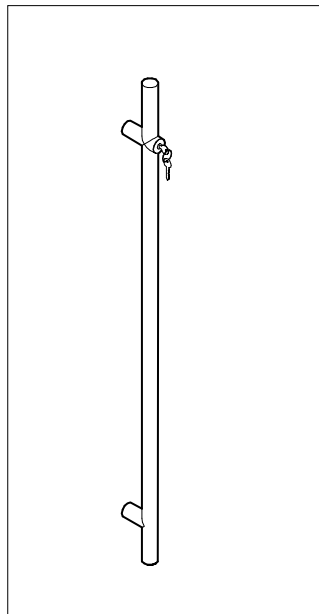

**MPOM3**

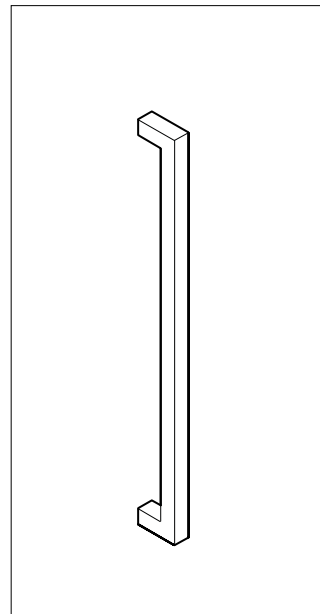

**MPOMGH1Q\_GH2Q\_GH3Q**

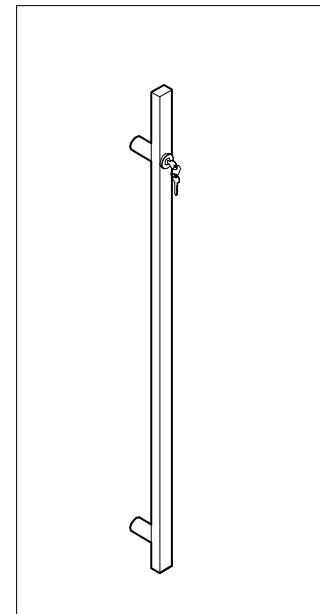

**MPOM3Q**

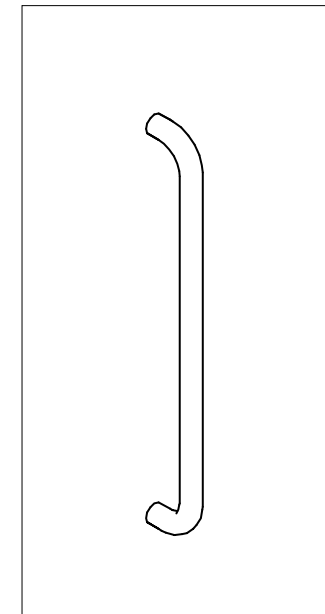

**MPOM8**

ALLUMINIO

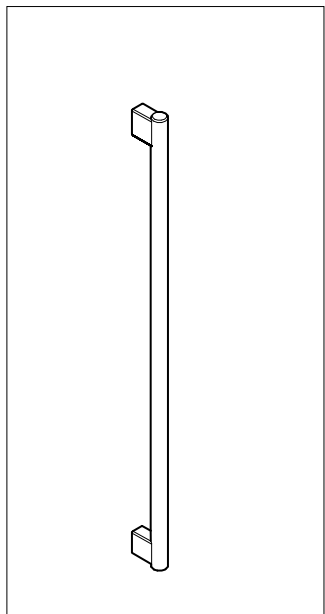

**MPOMTH1\_TH2**

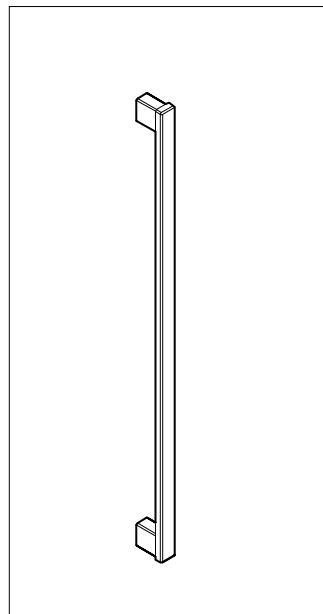

**MPOMQH1\_QH2**

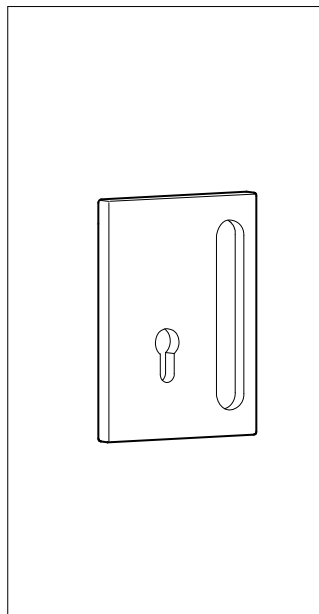

**MPOM6**

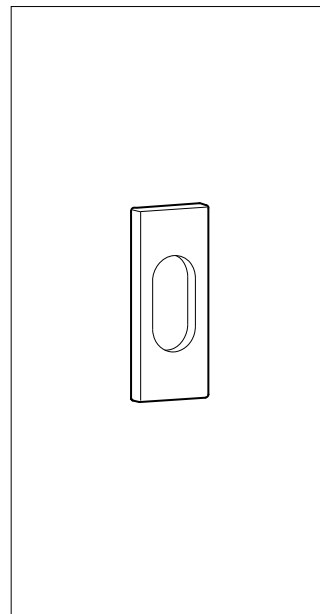

**MPOM7**

# Porte cieche



ACCIAIO

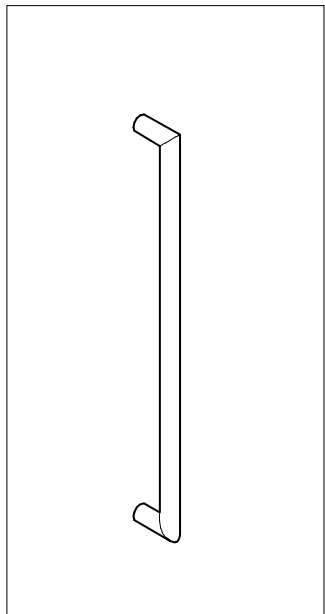

**MPOMGH1\_H2\_H3**

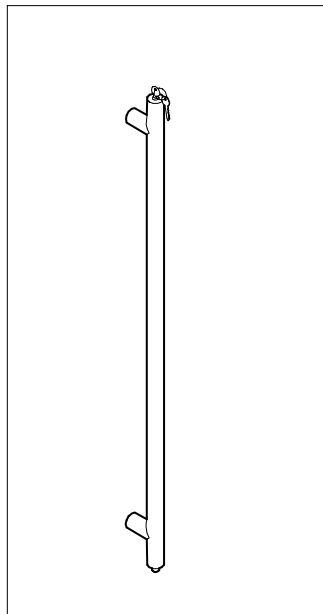

**MPOM2**

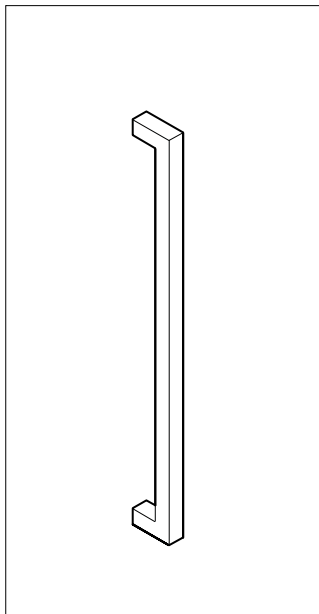

**MPOMGH1Q\_GH2Q\_GH3Q**

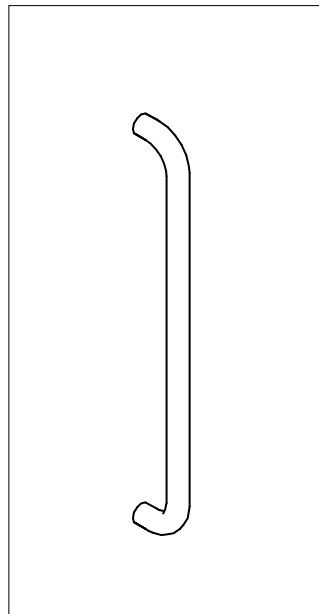

**MPOM8**

ALLUMINIO

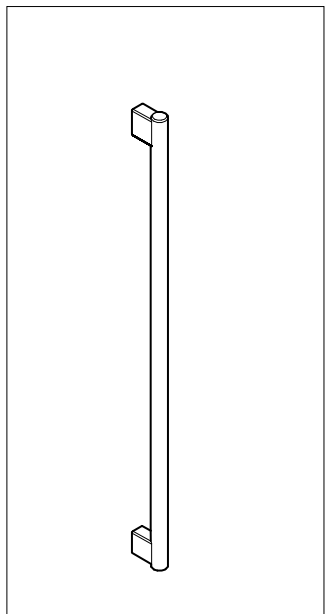

**MPOMTH1\_TH2**

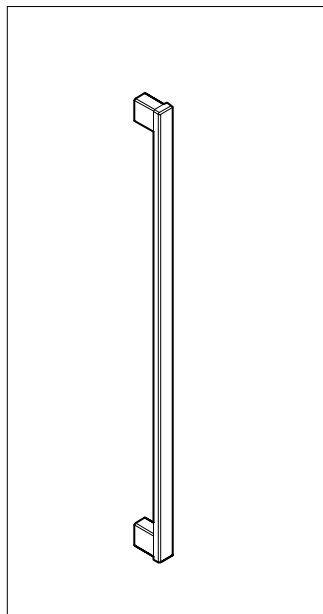

**MPOMQH1\_QH2**

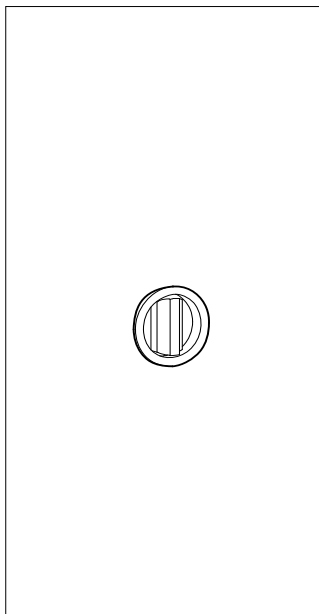

**MPOM4**

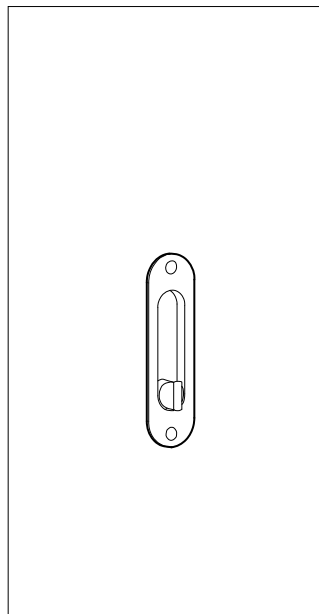

**MPOM5**

**METRICA**<sup>®</sup>  
SENZA STRUTTURA

Accessori

---





## Chiudiporta aerei

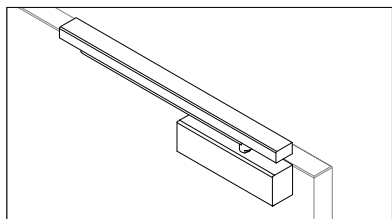

**01 esterno a slitta**  
*per anta cieca/intelaiata*

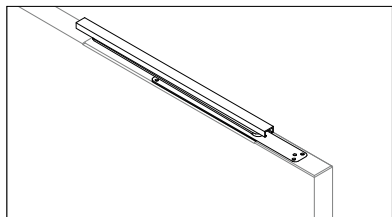

**02 a scomparsa**  
*per anta cieca/intelaiata*

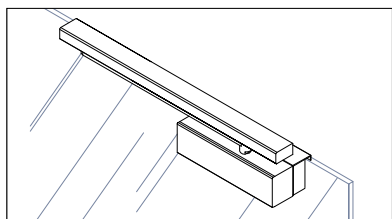

**03 esterno a slitta con supporto**  
*per anta in vetro temperato*

## Chiudiporta a terra

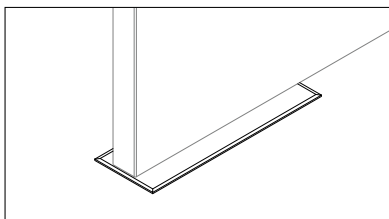

**01 a pavimento**  
*per anta cieca*

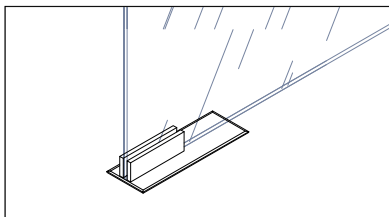

**02 a pavimento**  
*per anta in vetro temperato*

## Cerniere in alluminio

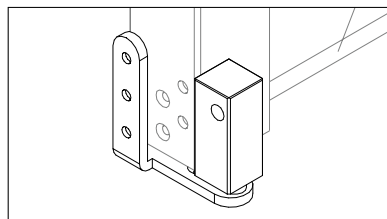

**01 a bilico esterno**  
*per anta cieca/intelaiata*

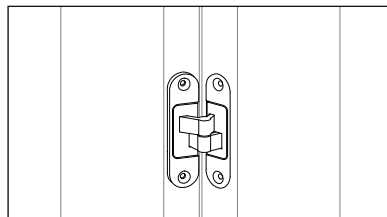

**02 a scomparsa**  
*per anta cieca/intelaiata*

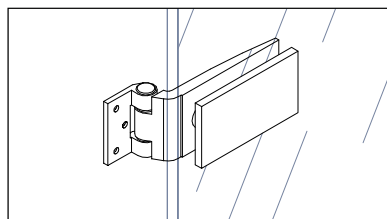

**03 apertura 180°**  
*per anta in vetro temperato*

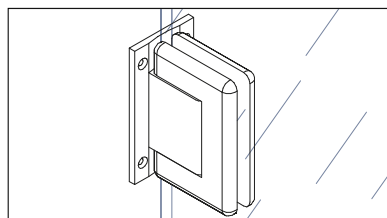

**04 va e vieni velocità regolabile**  
*per anta in vetro temperato*

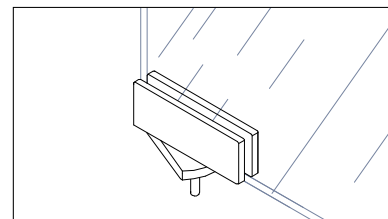

**05 va e vieni velocità regolabile**  
*per anta in vetro temperato*

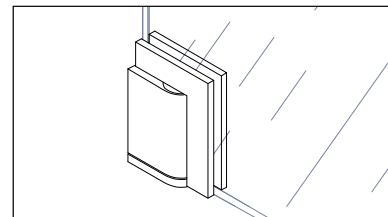

**06 va e vieni velocità regolabile**  
*per anta in vetro temperato*

## Accessori

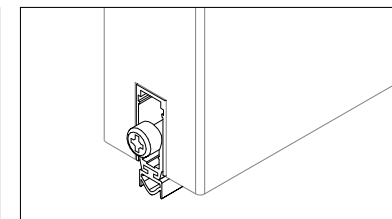

**01 antispiffero insonorizzante**  
*per anta cieca/intelaiata*

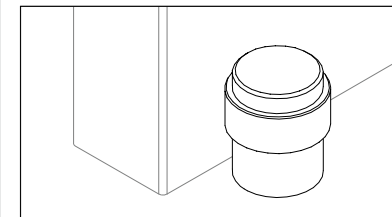

**02 fermaporte**  
*per anta cieca/intelaiata/temperato*

**METRICA**<sup>®</sup>  
SENZA STRUTTURA

Finiture

---



**Anodizzati**

**Finiture RAL**

**Lucidatura**

**Legni**



**01** Alluminio naturale



**01** Bianco

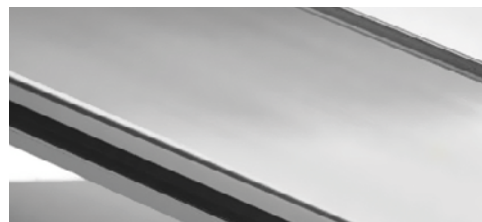

**01** Brillantato



**01** Rovere chiaro



**02** Bronzo

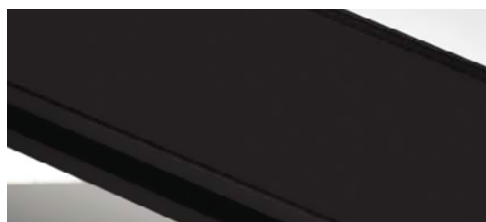

**02** Nero

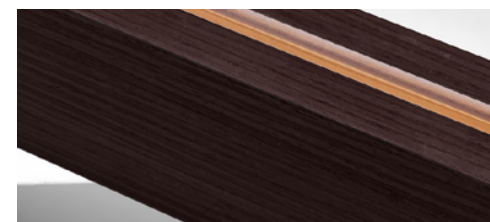

**02** Rovere scuro

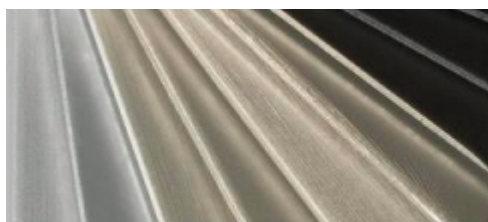

**03** Colore a campione



**03** Colore a campione

# Pannelli ciechi



CAT. 1

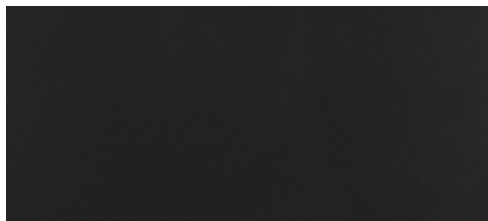

**055** Nero grafite

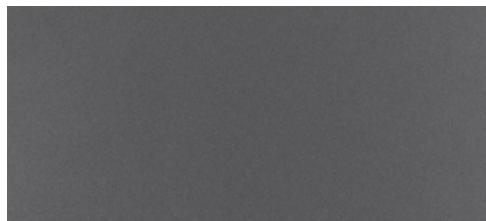

**420** Piombo



**418** Grigio cenere

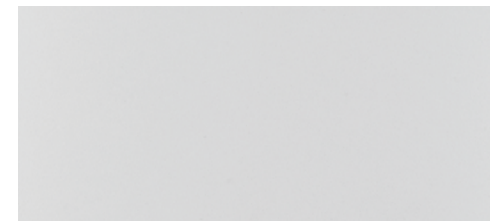

**419** Grigio chiaro

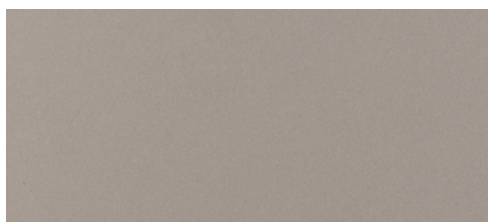

**393** Tortora



**417** Vaniglia

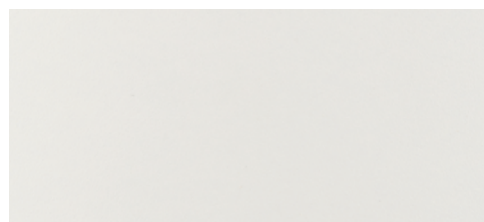

**429** Bianco caldo

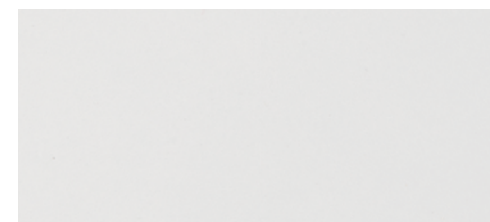

**428** Bianco freddo

CAT. 2



**422** Argento

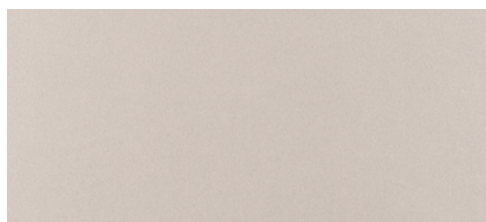

**423** Champagne



# Legni



CAT. 1

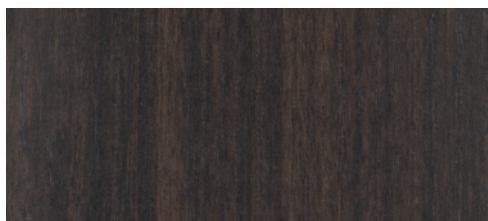

**421** Eucalipto

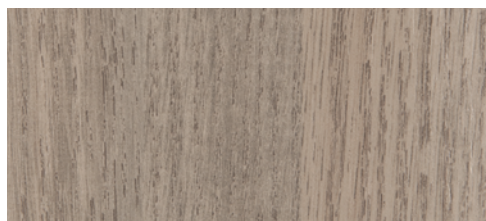

**426** Rovere medio



**274** Acacia



**416** Bianco venato

CAT. 2

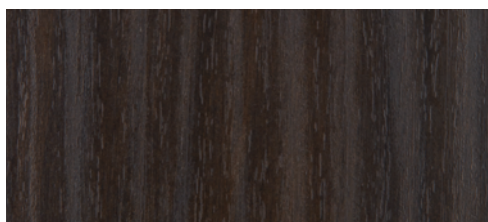

**425** Noce scuro

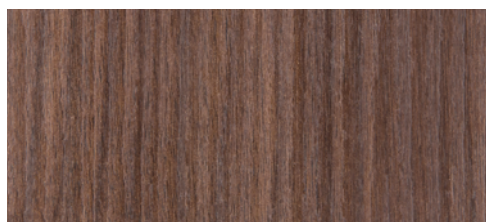

**318** Noce medio

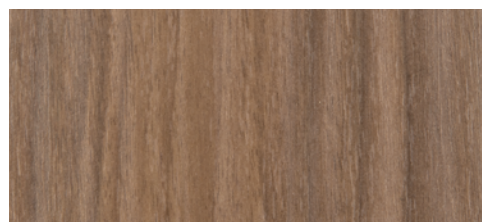

**427** Noce chiaro

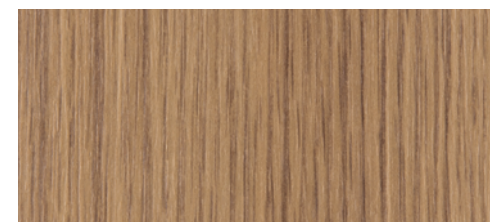

**382** Rovere naturale

CAT. 3



**138** Rovere invecchiato - taglio seta

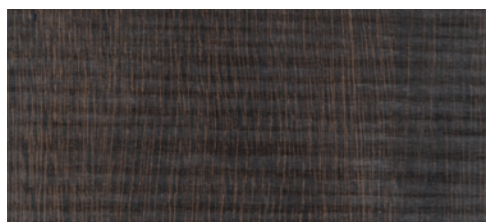

**197** Eucalipto - taglio seta

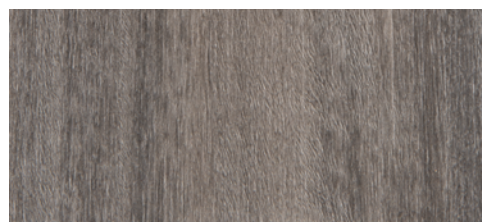

**408** Rovere grigio

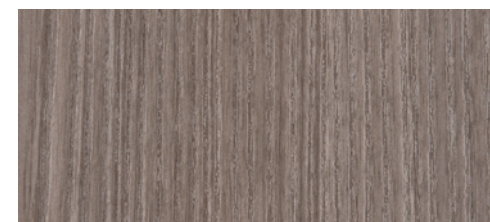

**400** Rovere Danubio

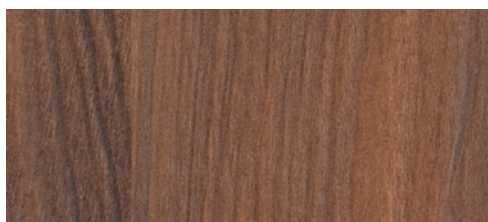

**414** Noce rosso

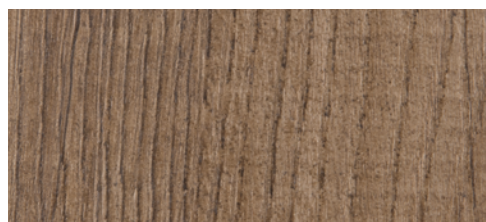

**412** Rovere vintage



**413** Rovere champagne



**410** Rovere chiaro

# Materici



CAT. 2

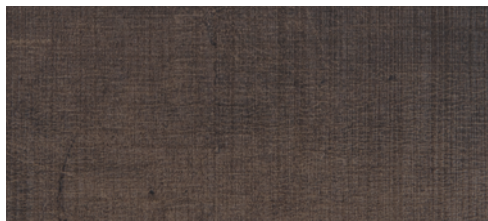

**304** Tessuto scuro



**123** Tessuto medio

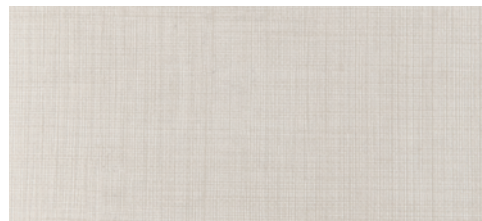

**305** Tessuto chiaro



**424** Ossido

CAT. 3

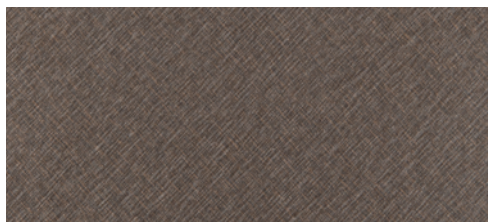

**385** Lino bronzo

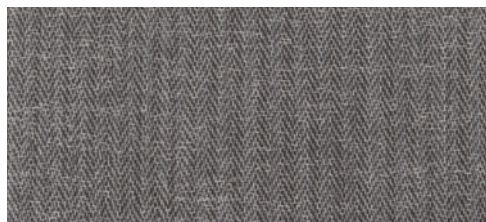

**409** Corteccia

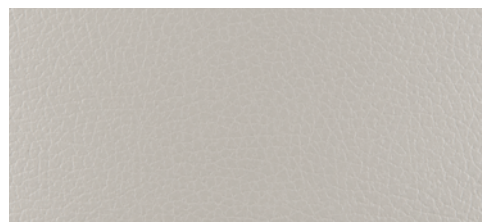

**406** Primo fiore grigio

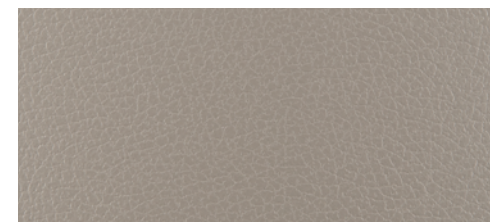

**405** Primo fiore tortora



**404** Primo fiore beige

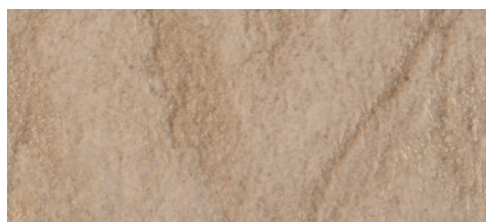

**415** Deserto



# Vetri



**01** Trasparente



**03** Satinato

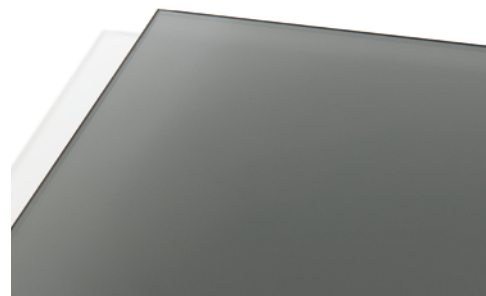

**05** Fumé



**02** Extrachiaro

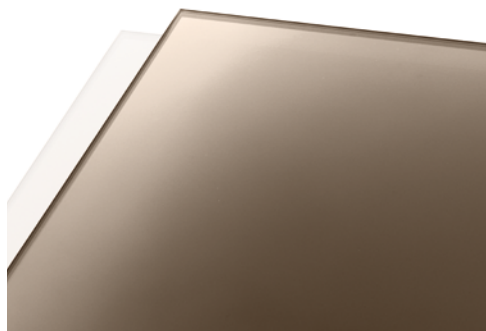

**04** Bronzo



**06** Verniciato a campione



**Etoile s.r.l. - Società Unipersonale**

Via D. Albertario, 50 61032 Zona Ind.le Bellocchi - Fano ( PU ) Italy

P. +39.0721.85.59.34 - F. +39.0721.85.92.14

info@etoilesrl.it - www.etoilesrl.it