



☐ ETOILE

METRICA[®]
SENZA STRUTTURA



Metrica è un sistema di pareti interne mobili senza struttura portante, fornita in sette soluzioni formalmente diverse.





METRICA® D1
vetro centrale

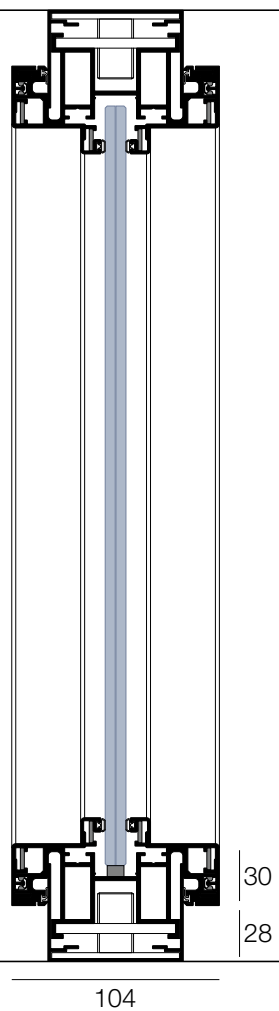

METRICA® D2
doppio vetro

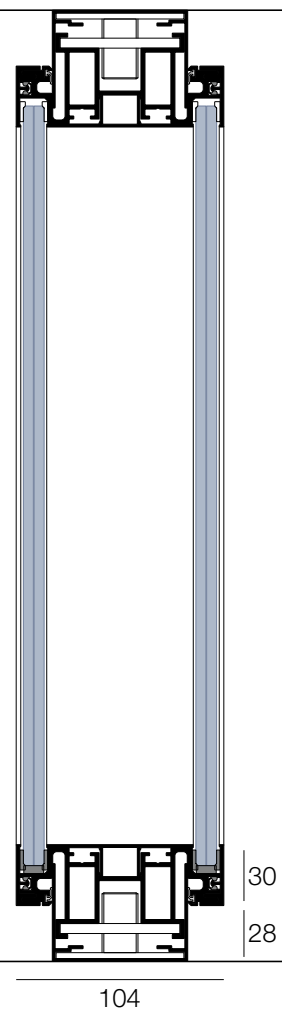

METRICA® SOLID
doppi pannelli ciechi 18 mm

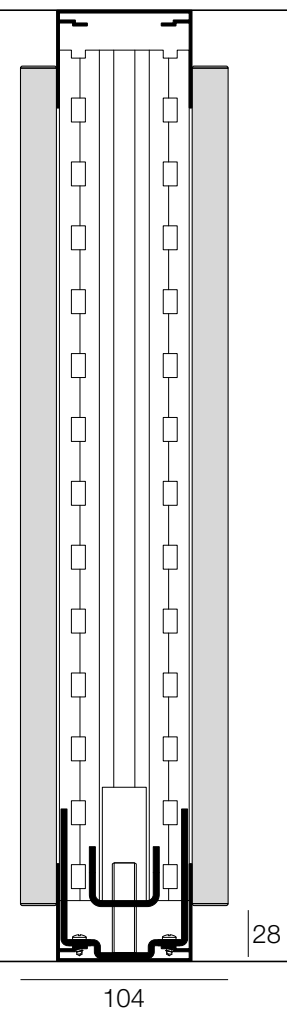



METRICA® F1

profilo incassato
vetro centrale

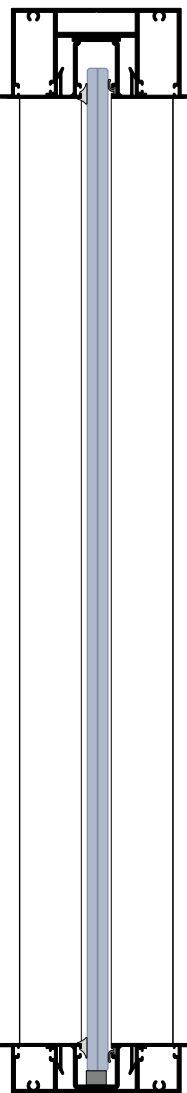

97

25

METRICA® FA

profilo incassato
vetro asimmetrico

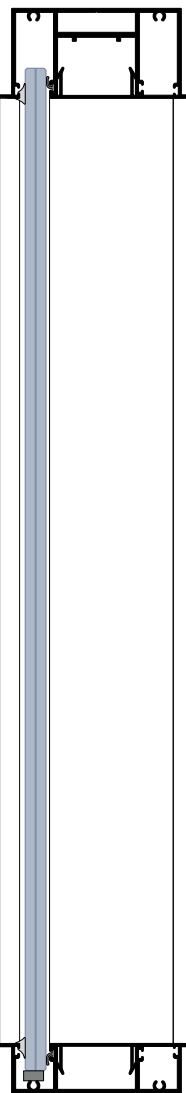

97

25

METRICA® F2

profilo incassato
doppio vetro

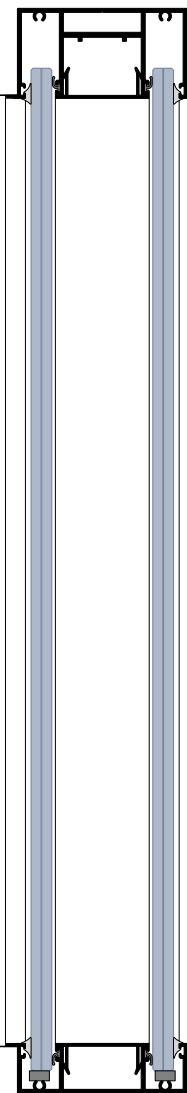

97

25

METRICA® F SOLID

profilo incassato
doppio pannello cieco

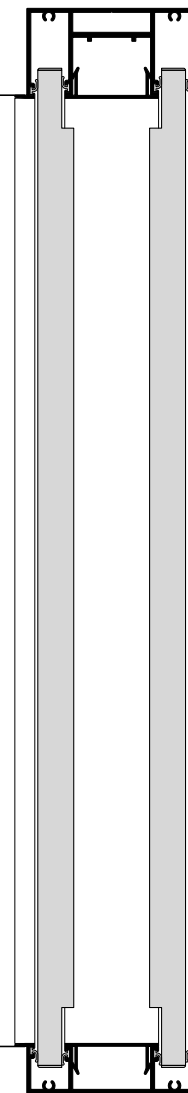

97

25





CARATTERISTICHE

- 01.** Spessore 104 mm della metrica D e 97 mm della metrica F
- 02.** Profili a pavimento, a soffitto, angoli e partenze in estruso di alluminio 6060 UNI 9006/1
- 03.** 3 versioni con profili fermavetro orizzontali a vista - vetro singolo centrale, doppio intelaiato e pannelli ciechi
- 04.** 4 versioni con profili incassati - vetro singolo centrale, asimmetrico, doppio e pannelli ciechi
- 05.** 2 spessori di vetri di sicurezza o acustici impiegabili
- 06.** Profili d'angolo fissi e variabili - connessioni 2/3/4 vie
- 07.** Giunzioni verticali tra elementi vetrati in alluminio, policarbonato e biadesivo trasparente
- 08.** Telaio porta cablabile
- 09.** Modulo tecnico ispezionabile (solo su metrica D)
- 10.** 16 versioni di porte battenti - cieche, in vetro temperato e intelaiate
- 11.** 3 versioni di porte scorrevoli interne - cieche, in vetro temperato e intelaiate
- 12.** 5 versioni di porte scorrevoli esterne - cieche, in vetro temperato e intelaiate

METRICA[®] D1





- 01.** Spessore 104 mm
- 02.** Profili a pavimento, a soffitto, angoli e partenze in estruso di alluminio 6060 UNI 9006/1
- 03.** Vetro singolo centrale - spessore 55.1/55.2/66.1/66.2 o temperato 10/12 mm
- 04.** Profili d'angolo fissi e variabili - connessioni 2/3/4 vie
- 05.** Giunzioni verticali tra elementi vetrati in alluminio, policarbonato e biadesivo trasparente
- 06.** Telaio porta cablabile
- 07.** Modulo tecnico ispezionabile
- 08.** 16 versioni di porte battenti - cieche, in vetro temperato e intelaiate
- 09.** 5 versioni di porte scorrevoli esterne - cieche, in vetro temperato e intelaiate



Partenze

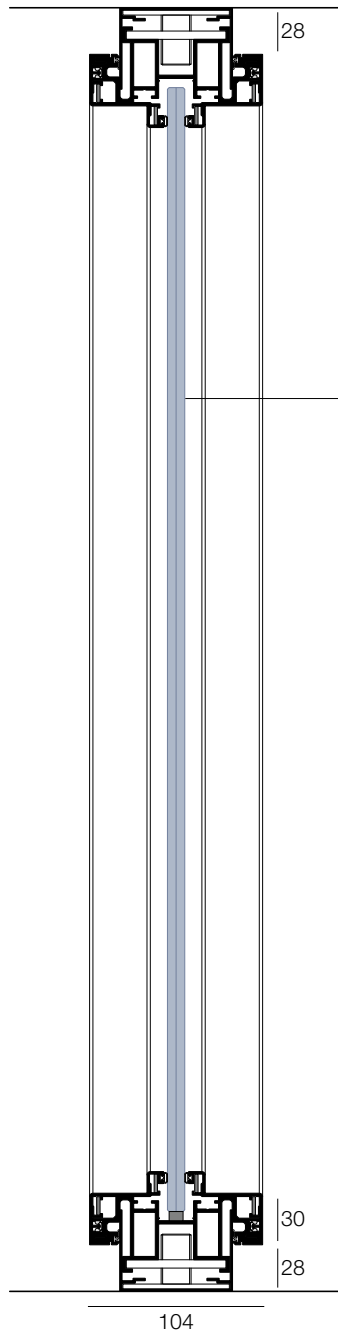

vetro 55.1 stratificato
vetro 55.2 stratificato
vetro 66.1 stratificato
vetro 66.2 stratificato

vetro 10 mm temperato
vetro 12 mm temperato

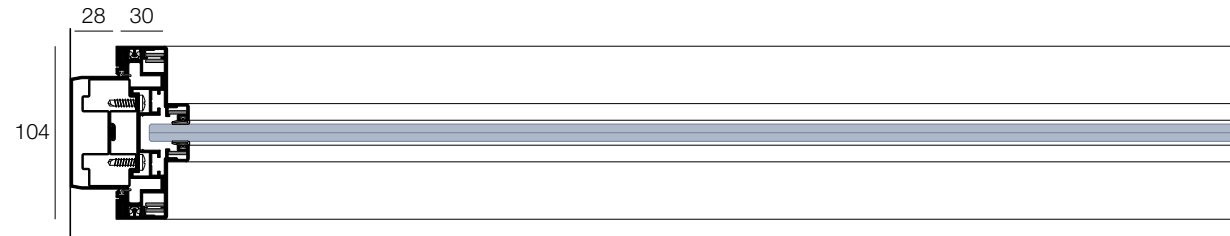

Partenza telescopica

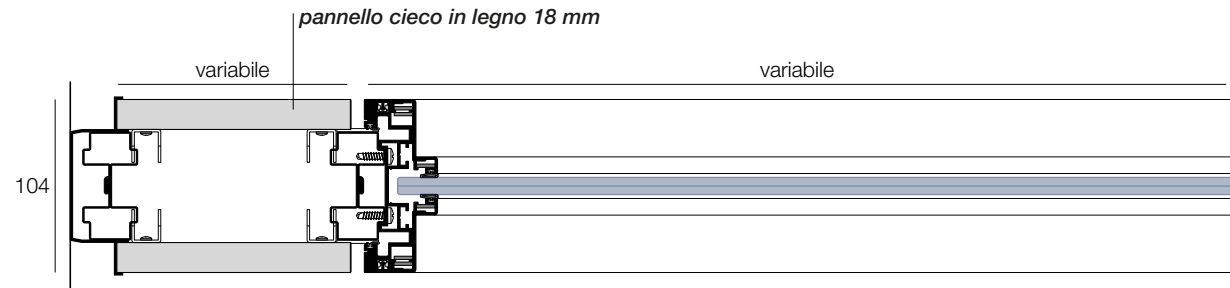

Partenza da tamponamento

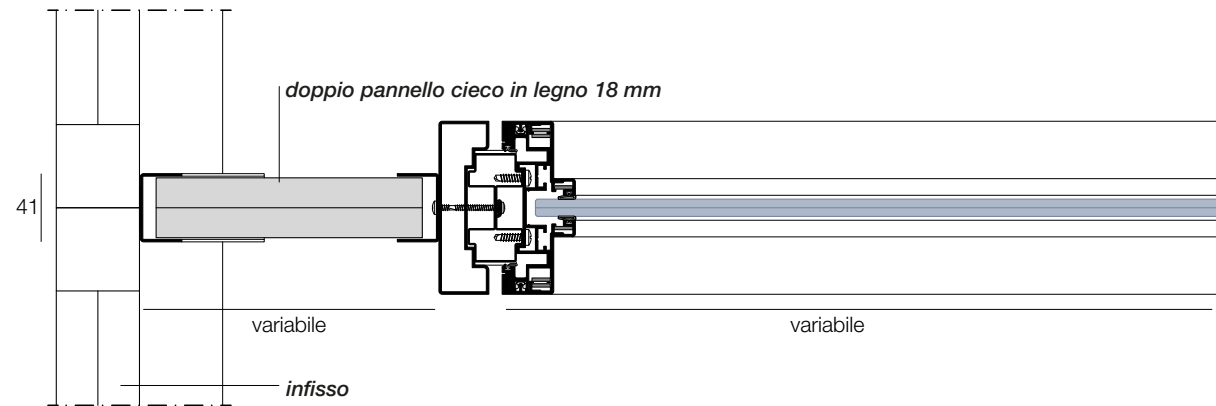

Partenza da parete

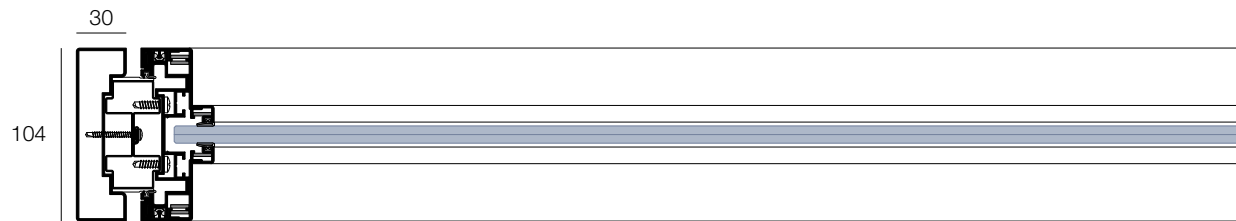

Profilo terminale

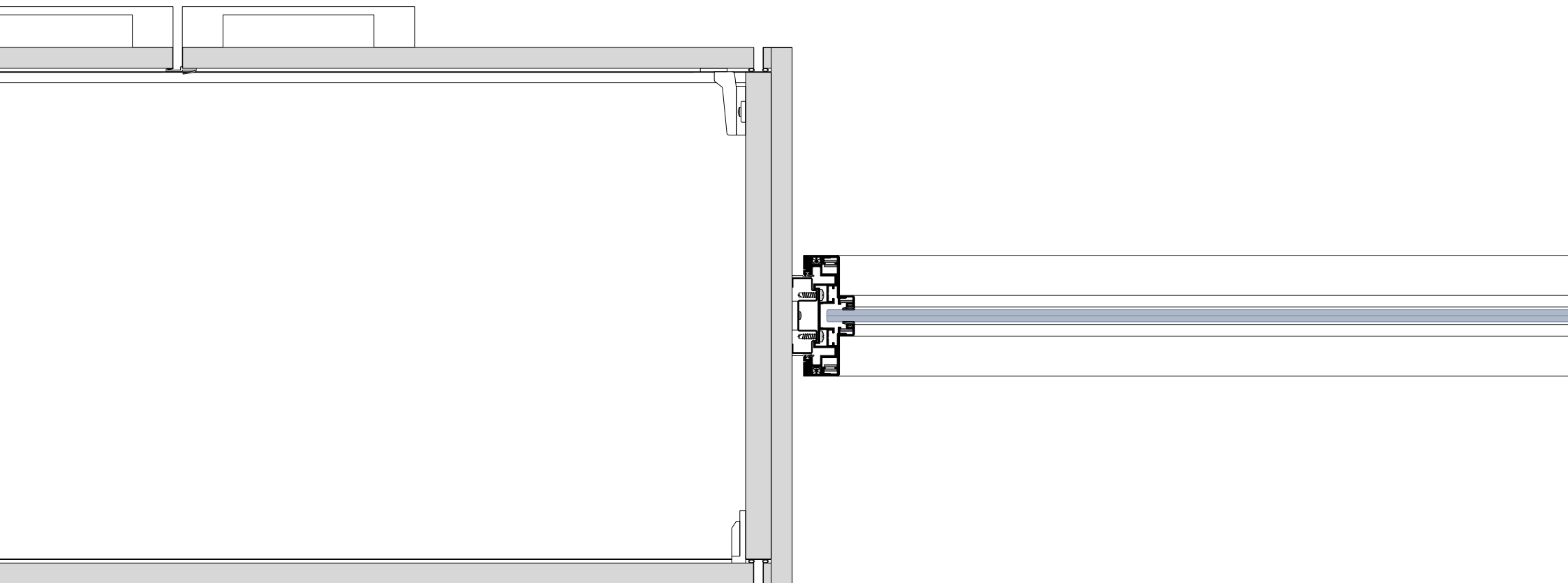

Partenza da contenitore



variabile



**Connessione
in alluminio**

**Connessione
in policarbonato**

**Connessione
con biadesivo tecnico**



**Connessione a tre vie
in policarbonato**

**Connessione a tre vie
con biadesivo tecnico**

Angoli

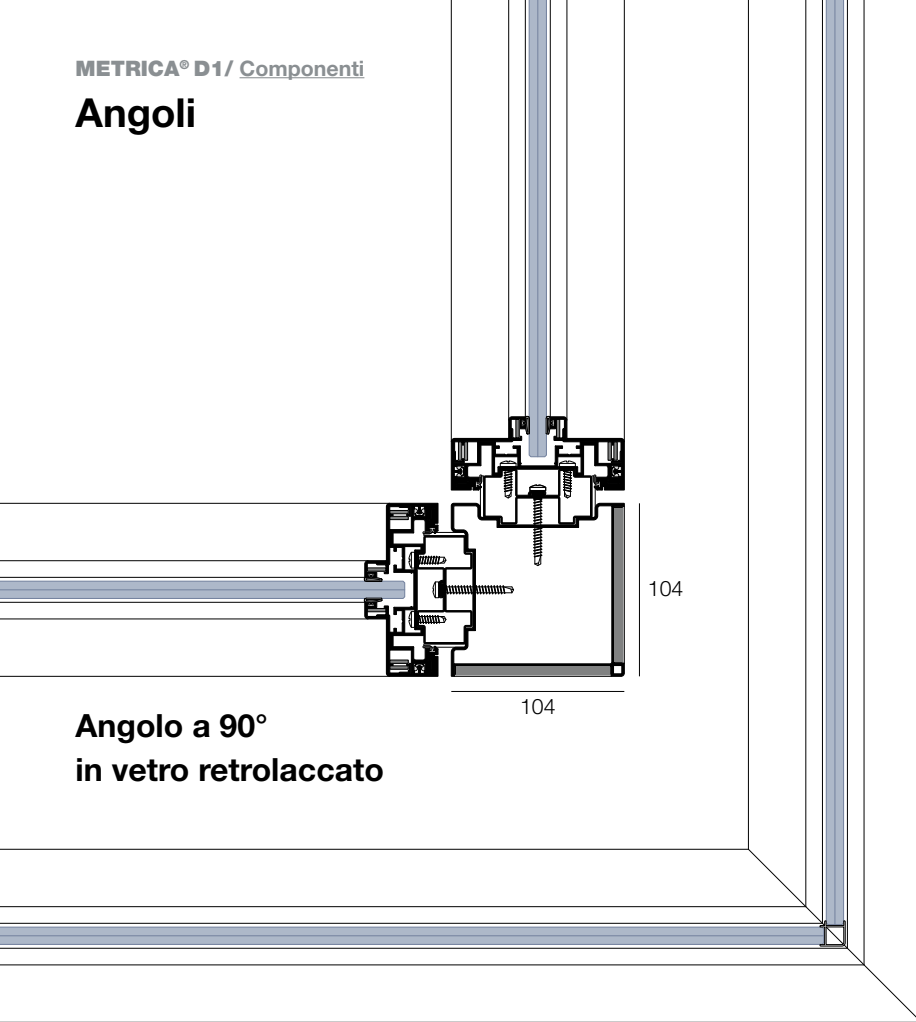

**Angolo a 90°
in vetro retrolaccato**

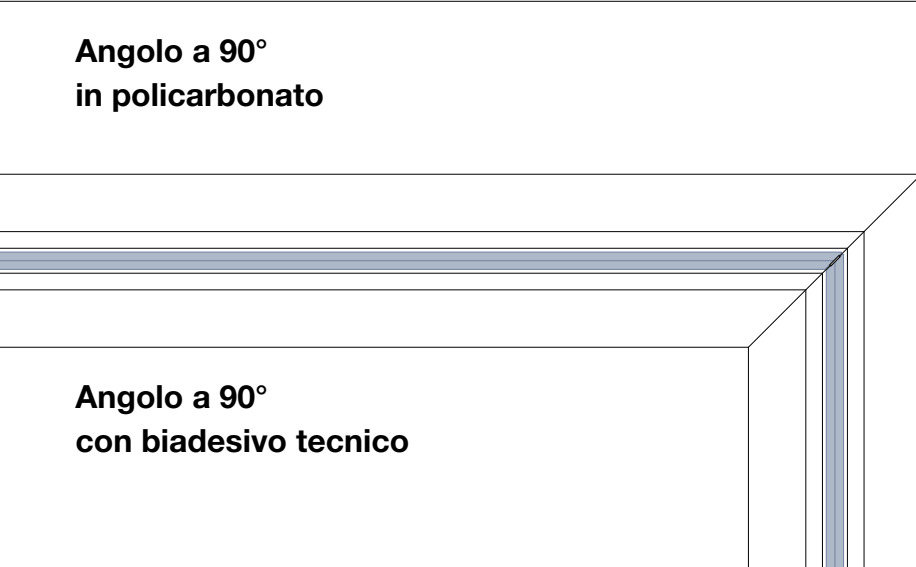

**Angolo a 90°
in policarbonato**

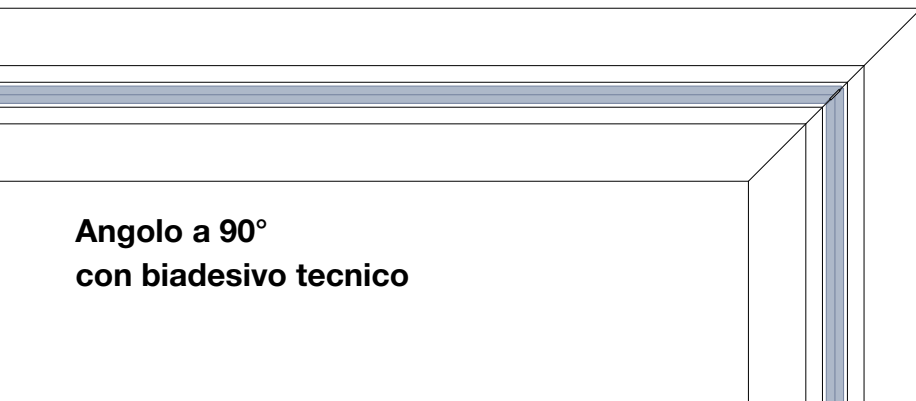

**Angolo a 90°
con biadesivo tecnico**

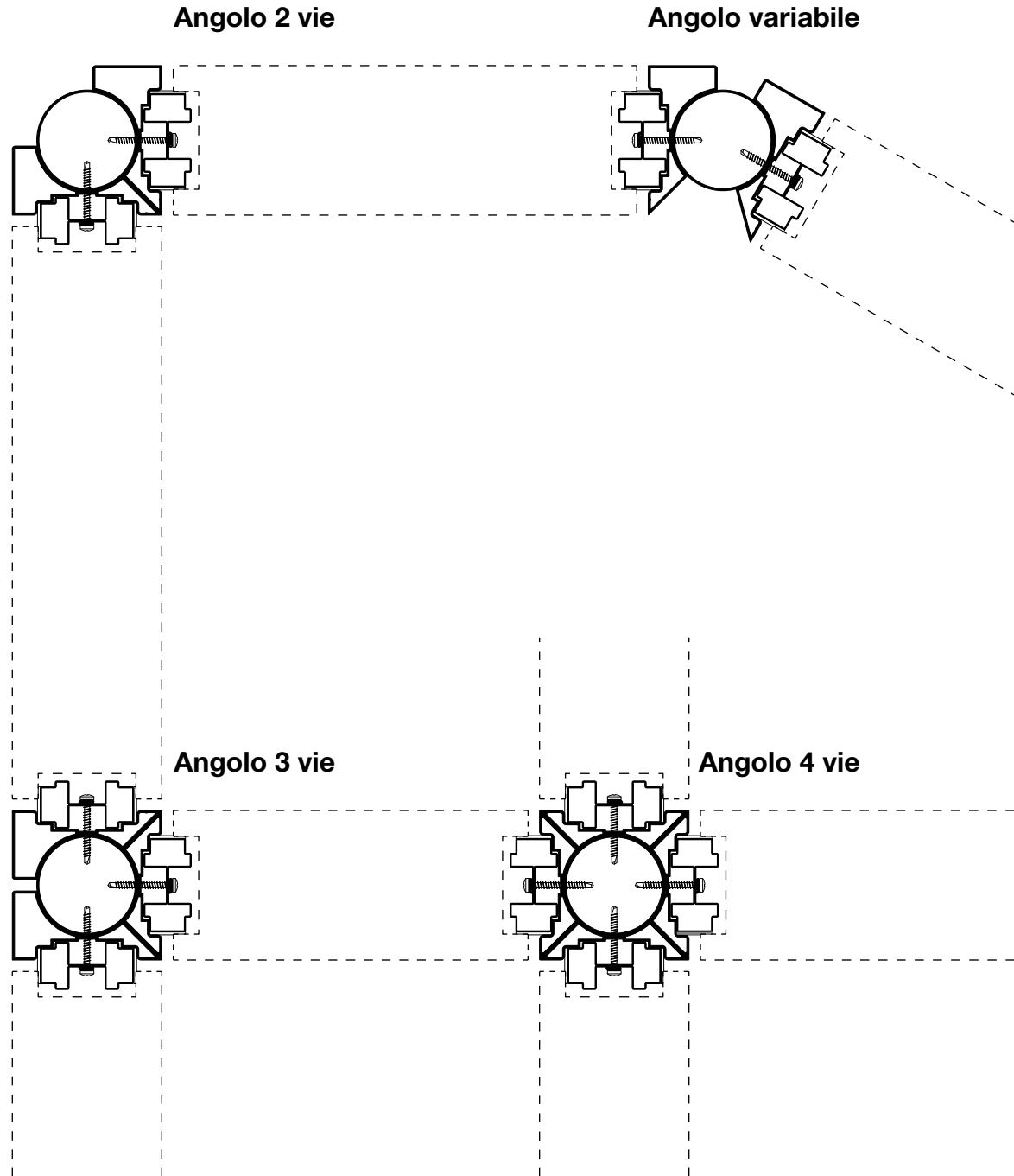

Angolo 2 vie

Angolo variabile

Angolo 3 vie

Angolo 4 vie

Cablaggio e modulo tecnico della porta a battente



Modulo tecnico

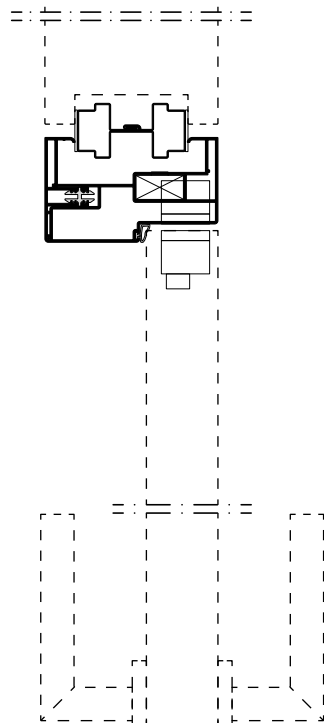
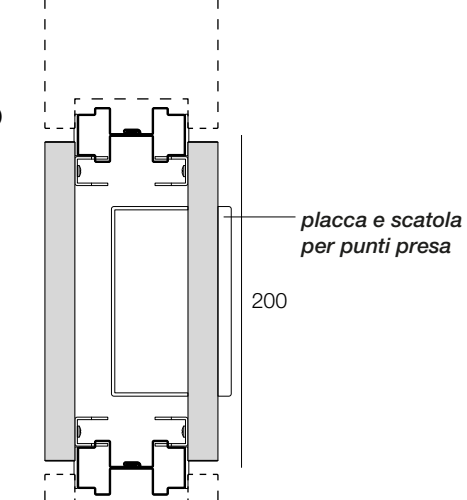

Soluzione di cablaggio

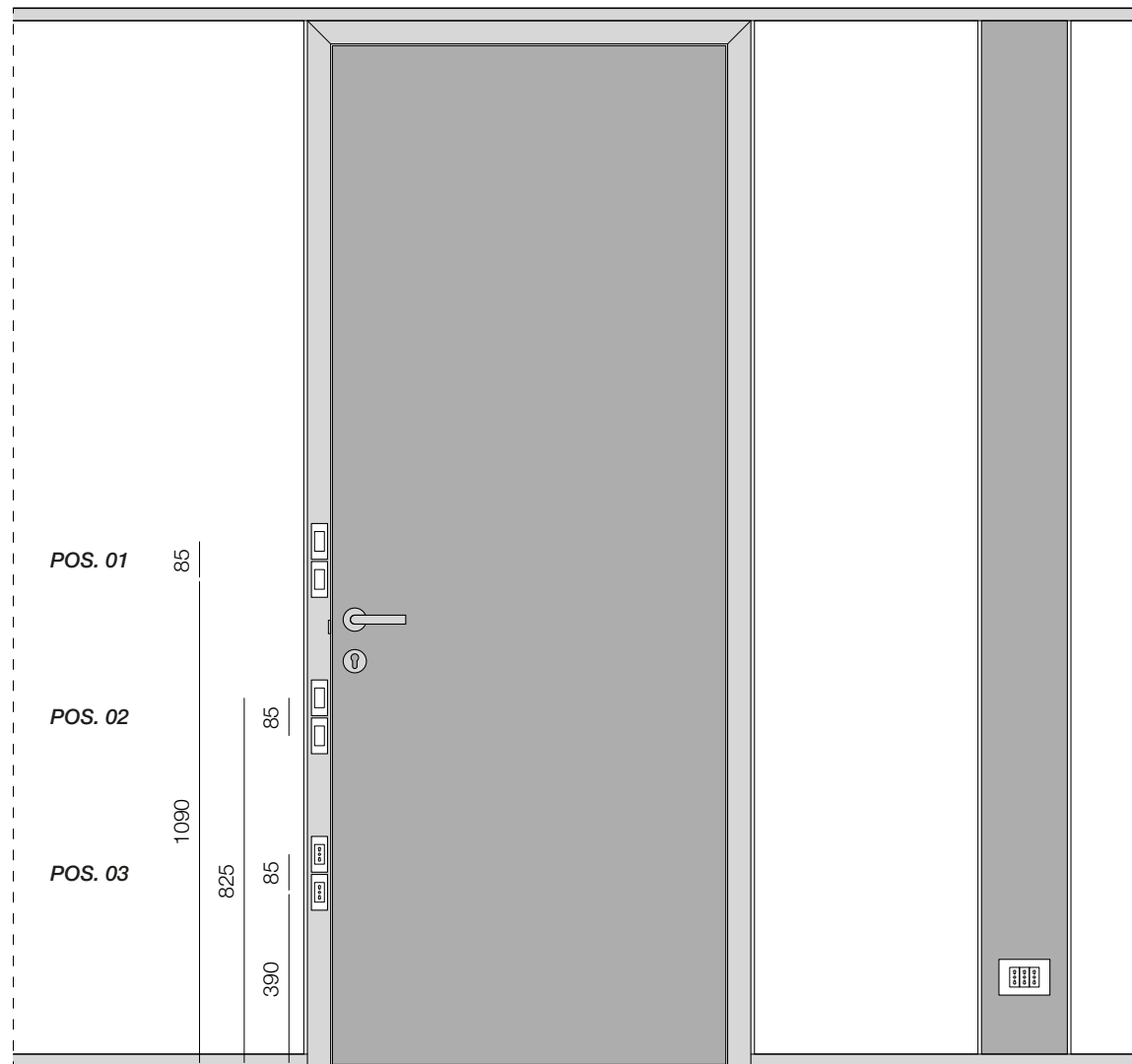
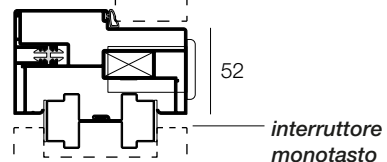

*posizioni possibili di interruttori e prese su telaio porta

Cablaggio e modulo tecnico della porta scorrevole



Modulo tecnico

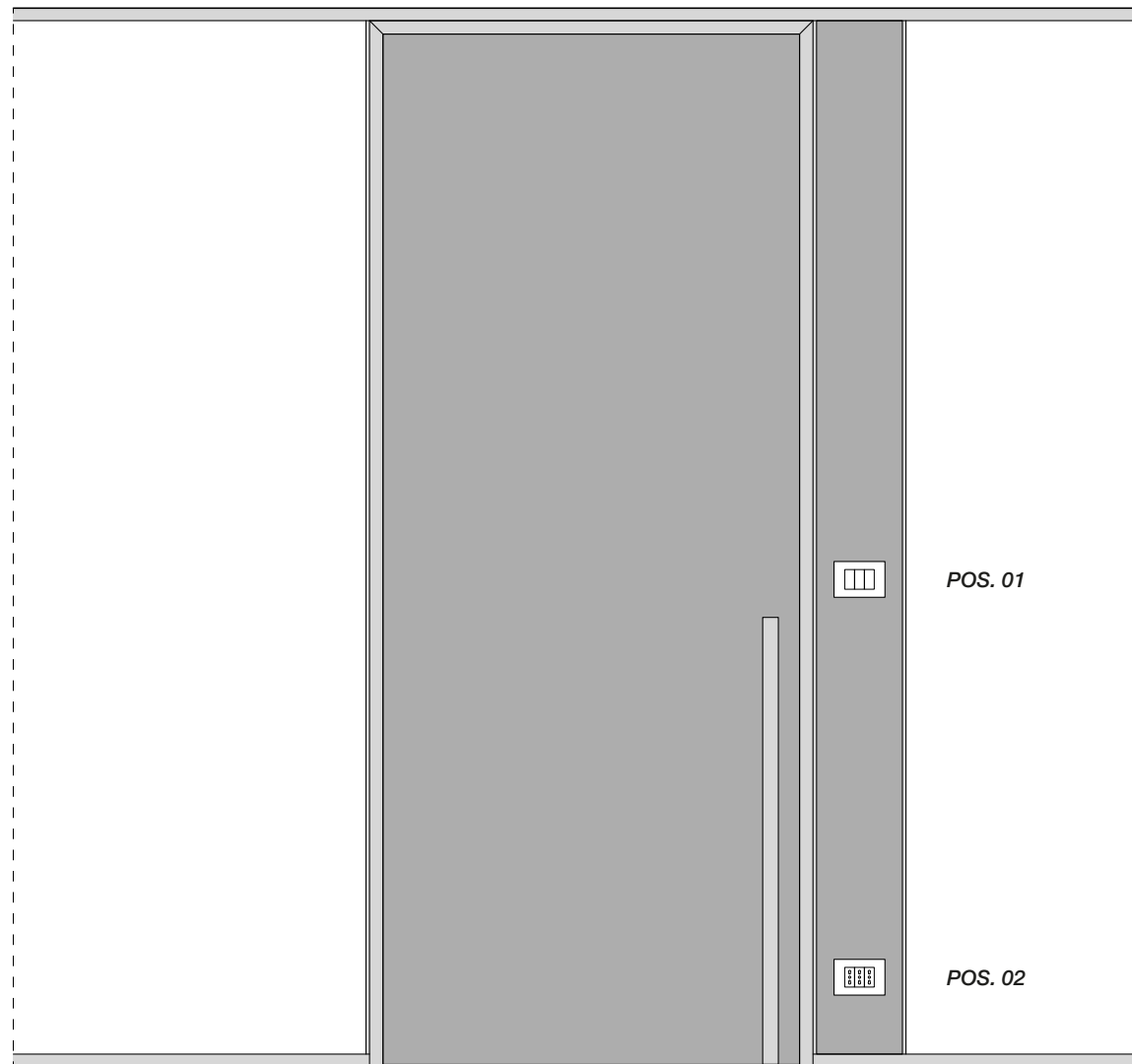
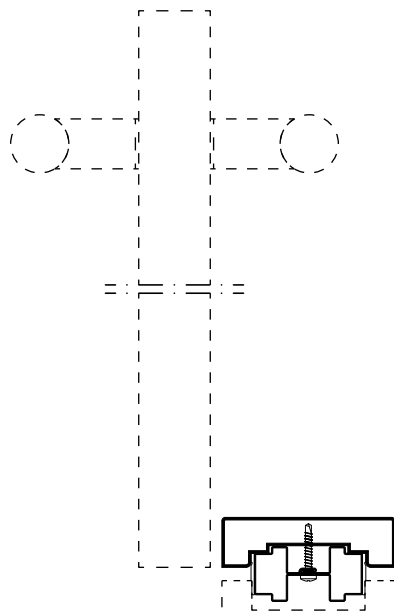
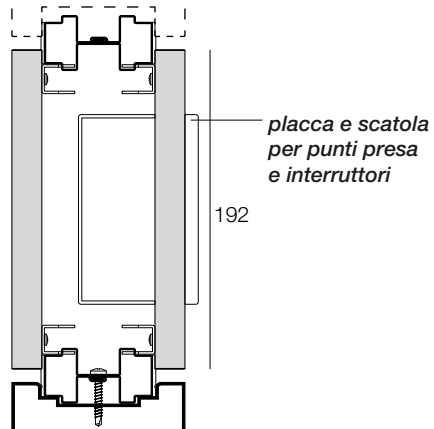

**posizioni possibili di interruttori e prese su modulo tecnico*

METRICA[®] D2





- 01.** Spessore 104 mm
- 02.** Profili a pavimento, a soffitto, angoli e partenze in estruso di alluminio 6060 UNI 9006/1
- 03.** Doppio vetro intelaiato - spessore 55.1/55.2/66.1/66.2 o temperato 10/12 mm
- 04.** Profili d'angolo fissi e variabili - connessioni 2/3/4 vie
- 05.** Giunzioni verticali tra elementi vetrati in alluminio, policarbonato e biadesivo trasparente
- 06.** Telaio porta cablabile
- 07.** Modulo tecnico ispezionabile
- 08.** 16 versioni di porte battenti - cieche, in vetro temperato e intelaiate
- 09.** 5 versioni di porte scorrevoli esterne - cieche, in vetro temperato e intelaiate

- 01.** Doppio vetro 55.1 - **39 dB**
- 02.** Doppio vetro 55.1 e 66.2 con pellicola acustica **41 dB**
- 03.** Doppio vetro 66.2 con pellicola acustica **43 dB**



Partenze

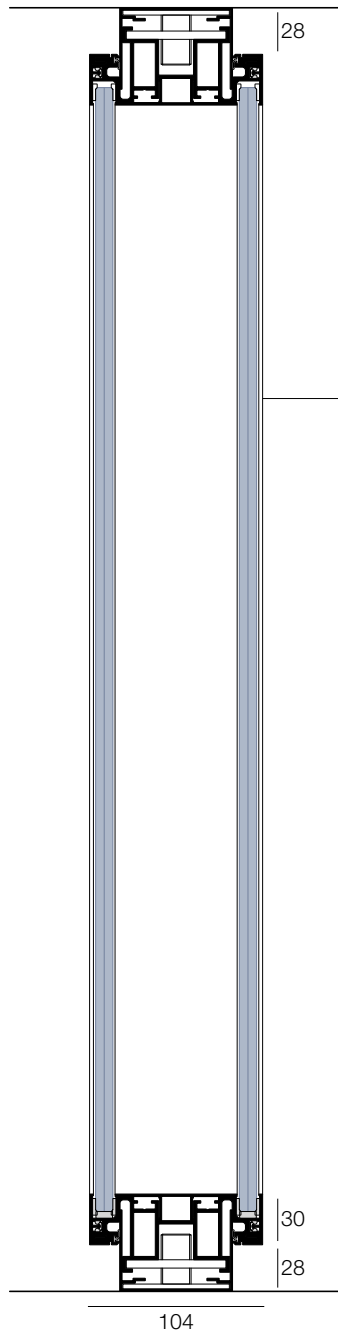

doppio vetro 55.1 stratificato
doppio vetro 55.2 stratificato
doppio vetro 66.1 stratificato
doppio vetro 66.2 stratificato

doppio vetro 10 mm temperato
doppio vetro 12 mm temperato

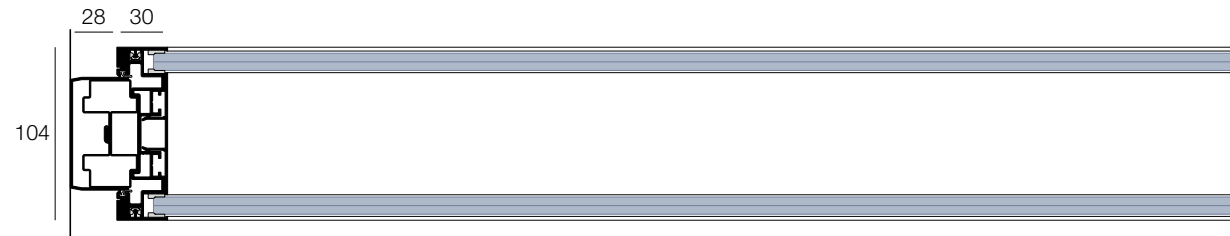

Partenza telescopica

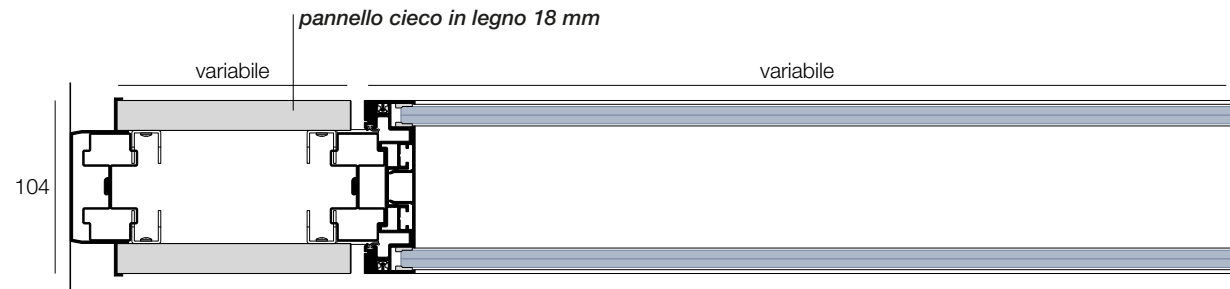

Partenza da tamponamento

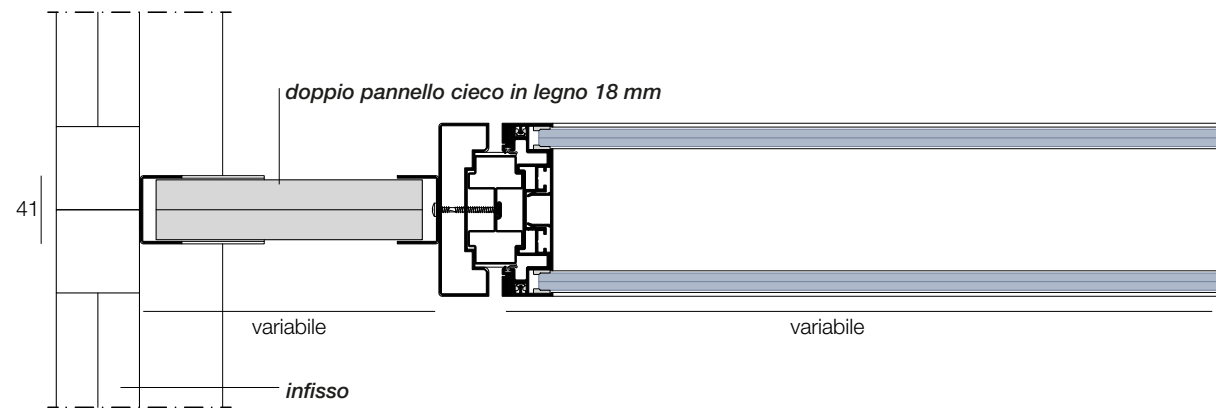

Partenza da parete

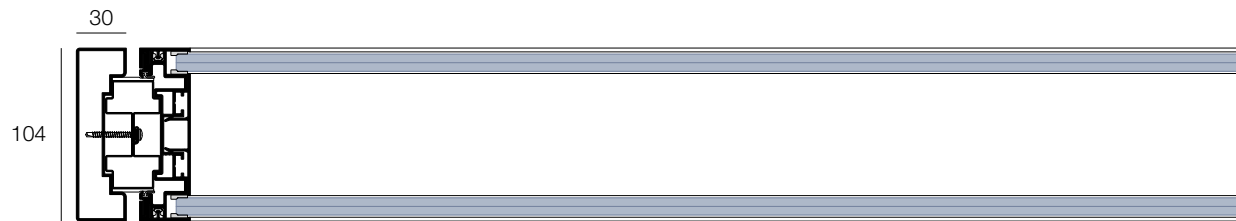

Profilo terminale

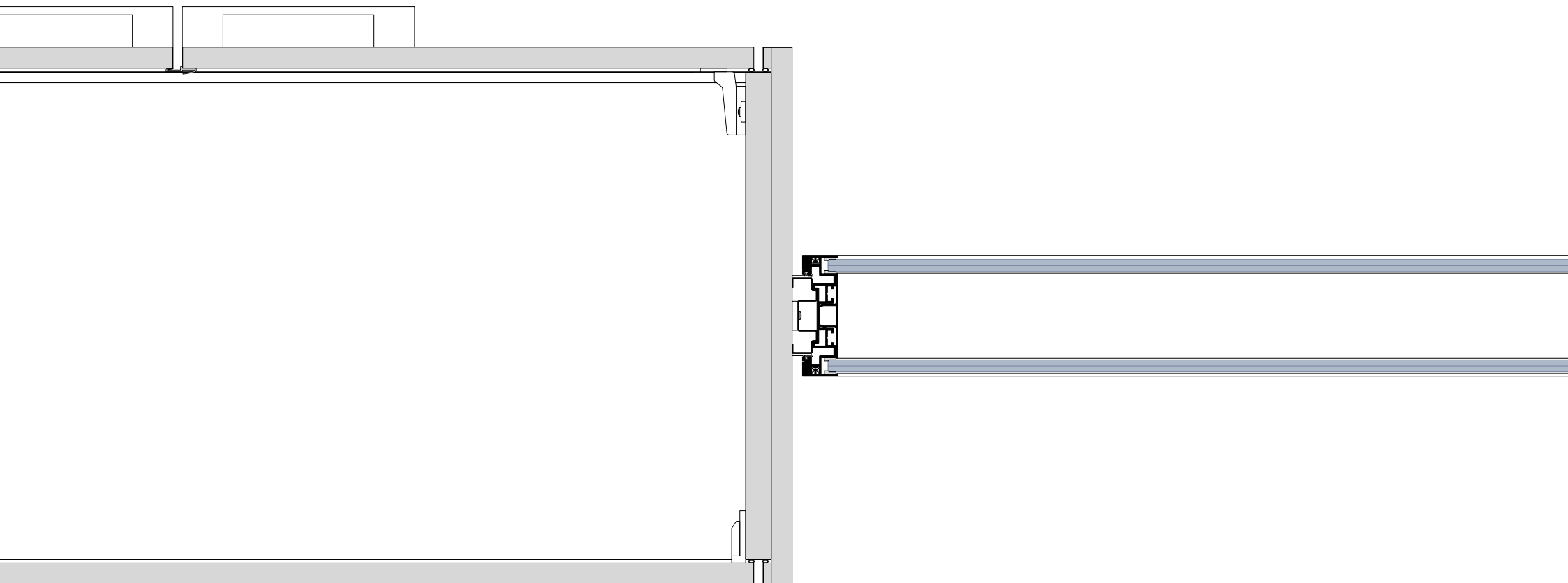

Partenza da contenitore



variabile



**Connessione
in alluminio**

**Connessione
in policarbonato**

**Connessione
con biadesivo tecnico**



**Connessione a tre vie
con biadesivo tecnico**

Angoli

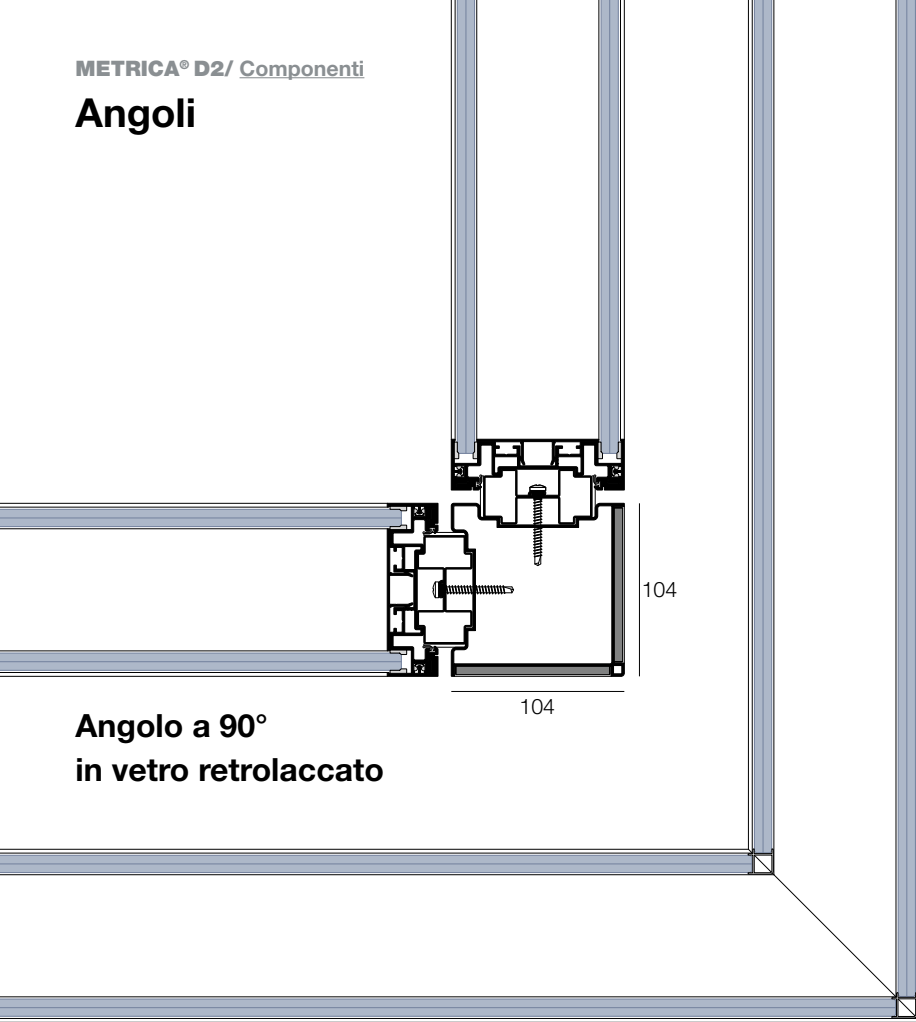

**Angolo a 90°
in vetro retrolaccato**

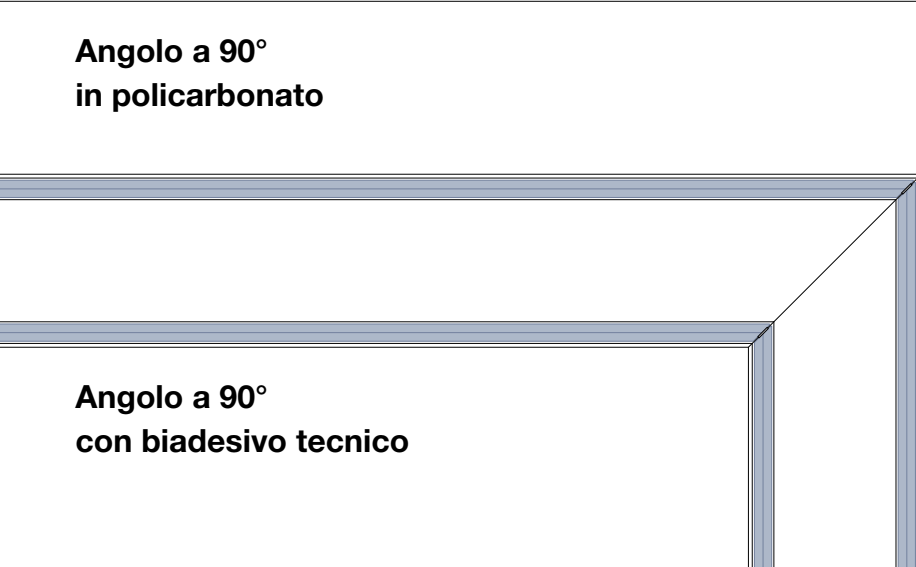

**Angolo a 90°
in policarbonato**

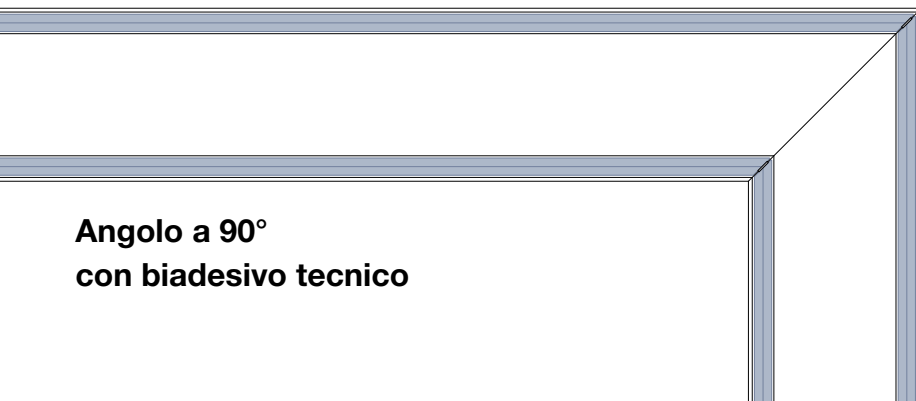

**Angolo a 90°
con biadesivo tecnico**

Angolo 2 vie

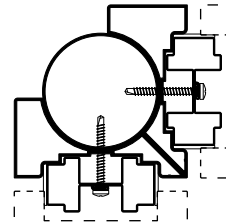

Angolo variabile

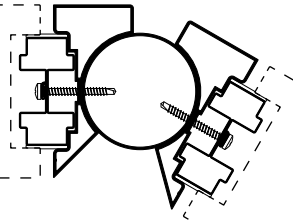

Angolo 3 vie

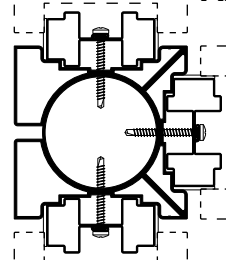

Angolo 4 vie

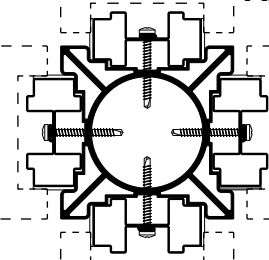

Cablaggio e modulo tecnico della porta a battente



Modulo tecnico

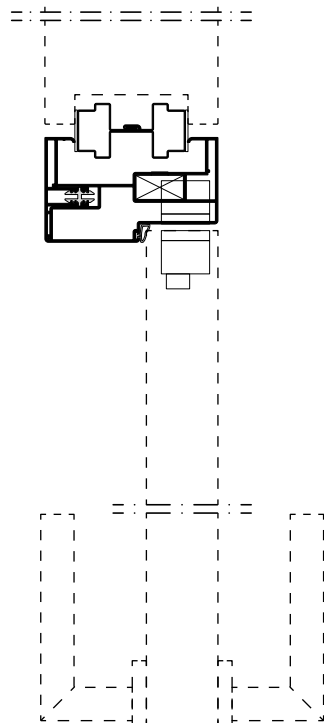
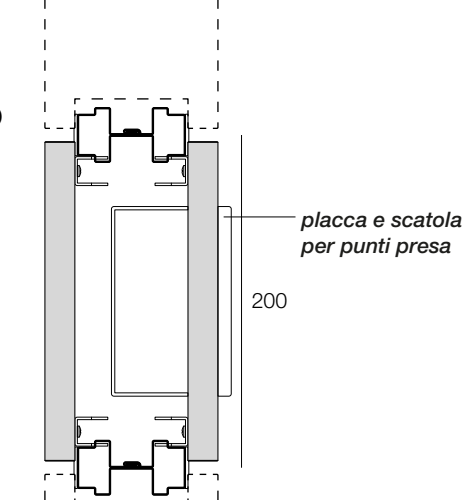

Soluzione di cablaggio

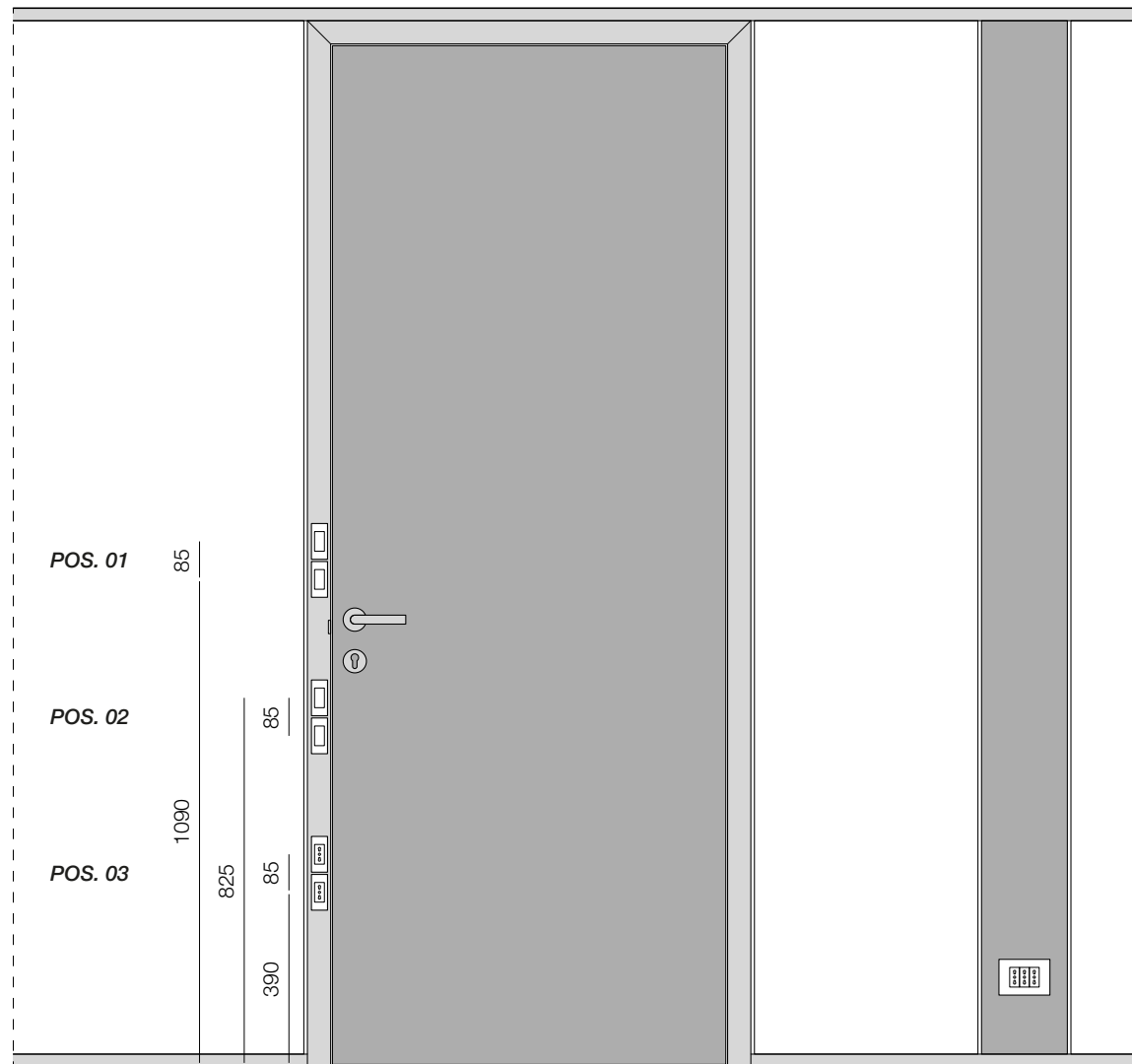
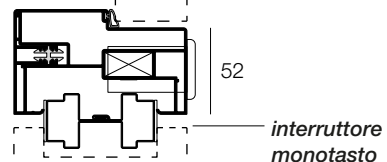

*posizioni possibili di interruttori e prese su telaio porta

Modulo tecnico della porta scorrevole



Modulo tecnico

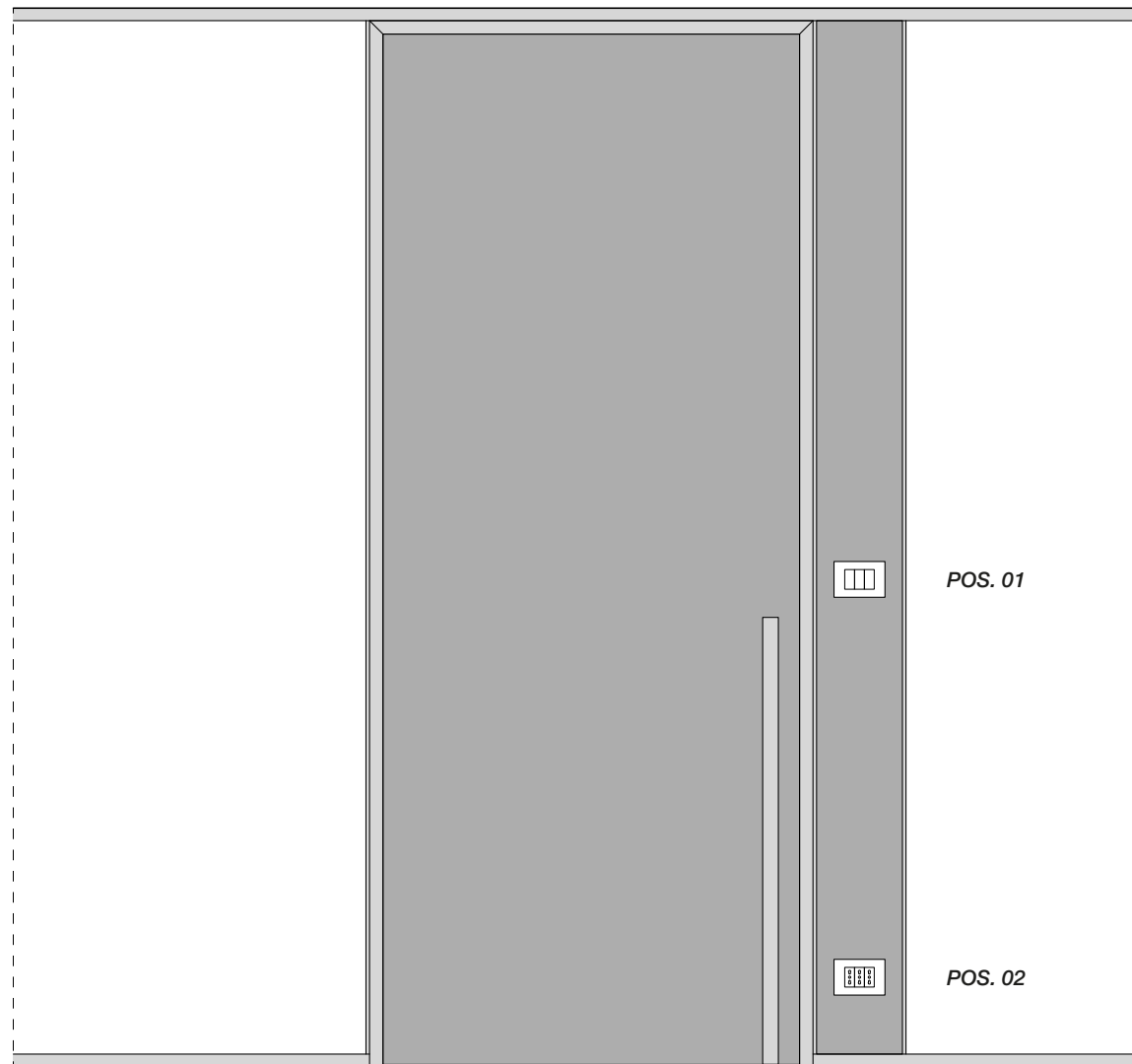
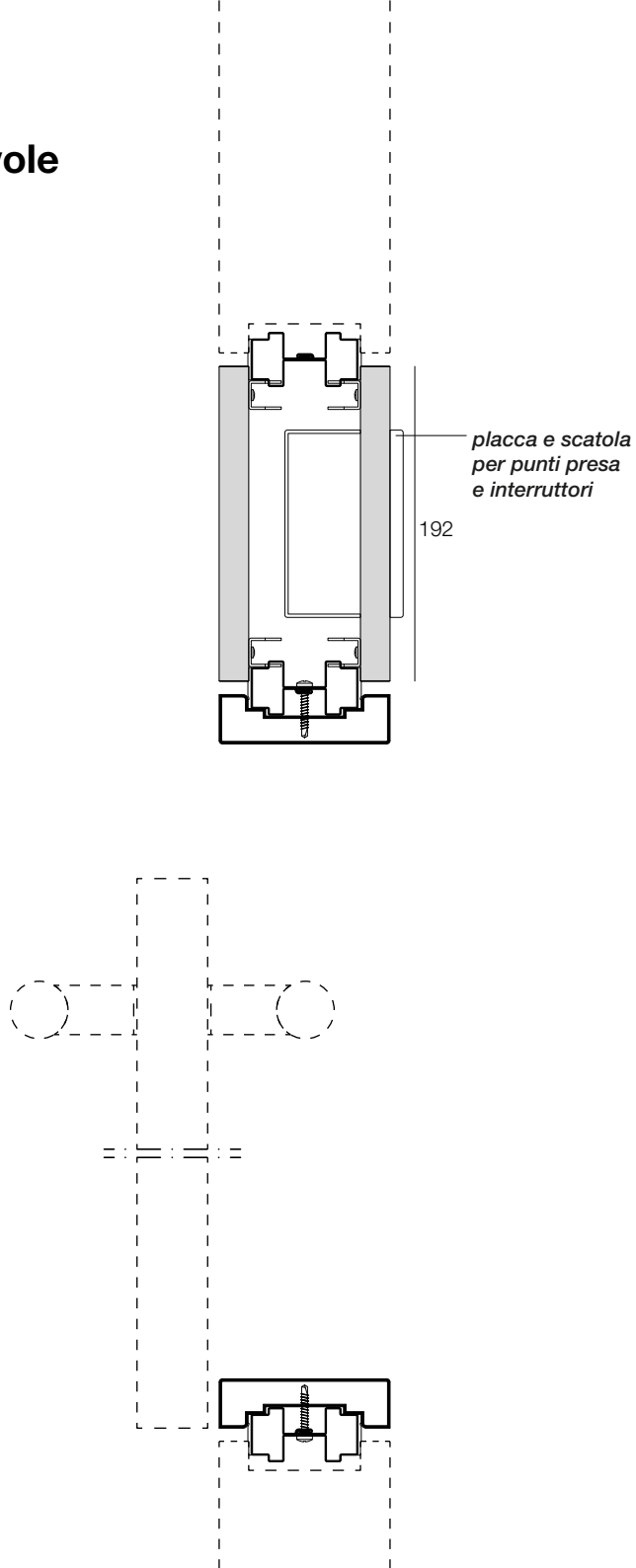

*posizioni possibili di interruttori e prese su modulo tecnico

METRICA[®] SOLID

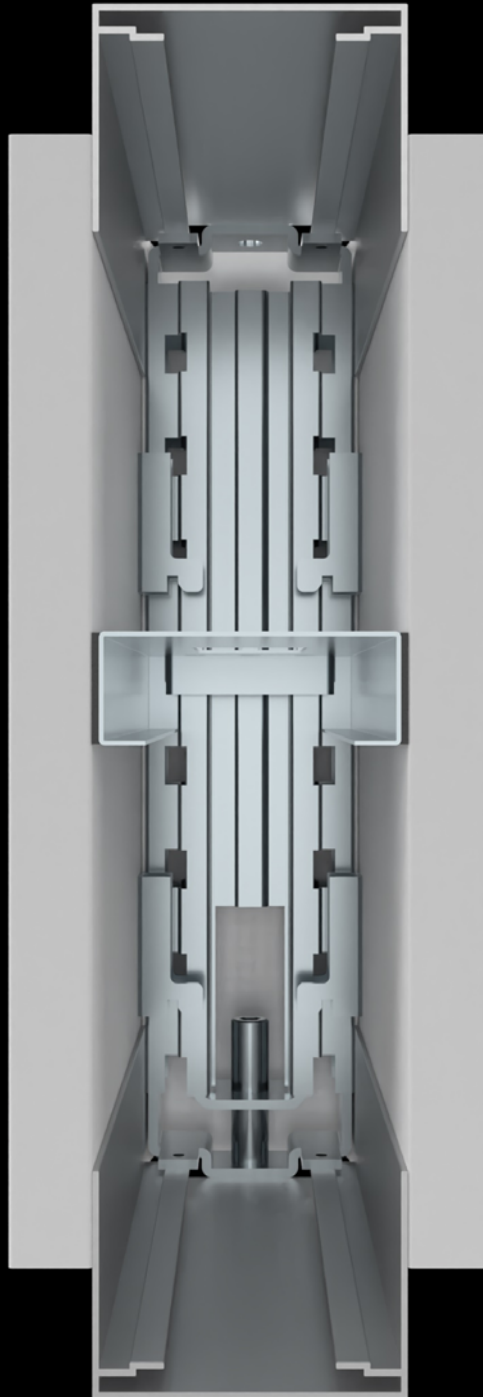



- 01.** Spessore 104 mm
- 02.** Struttura portante in lamiera zincata UNI EN 10143
- 03.** Parete a pannelli verticali e fasce orizzontali
- 04.** Pannelli a passo 500/1000/1500/2000 mm
- 05.** Doppi pannelli ciechi di nobilitato melaminico, laccati o impiallacciati - spessore 18 mm
- 06.** Profili d'angolo fissi e variabili - connessioni 2/3/4 vie
- 07.** Telaio porta cablabile
- 08.** Modulo tecnico ispezionabile
- 09.** 16 versioni di porte battenti - cieche, in vetro temperato e intelaiate
- 10.** 2 versioni di porte scorrevoli interne - cieche e in vetro temperato
- 11.** 5 versioni di porte scorrevoli esterne - cieche, in vetro temperato e intelaiate

- 01.** Pannelli verticali + coibentazione da **37 dB** a **44 dB**
- 02.** Pannelli orizzontali + coibentazione da **38 dB** a **46 dB**



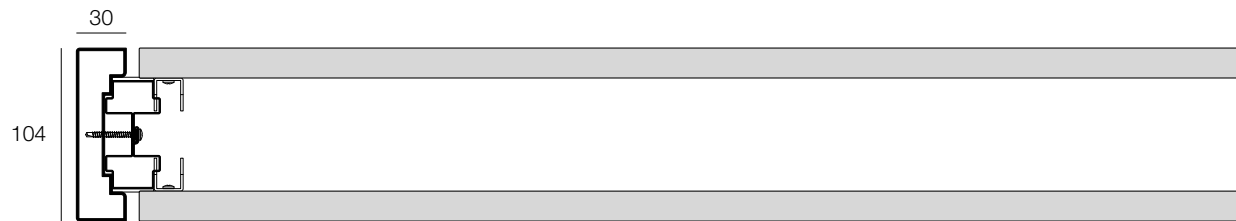

Profilo terminale

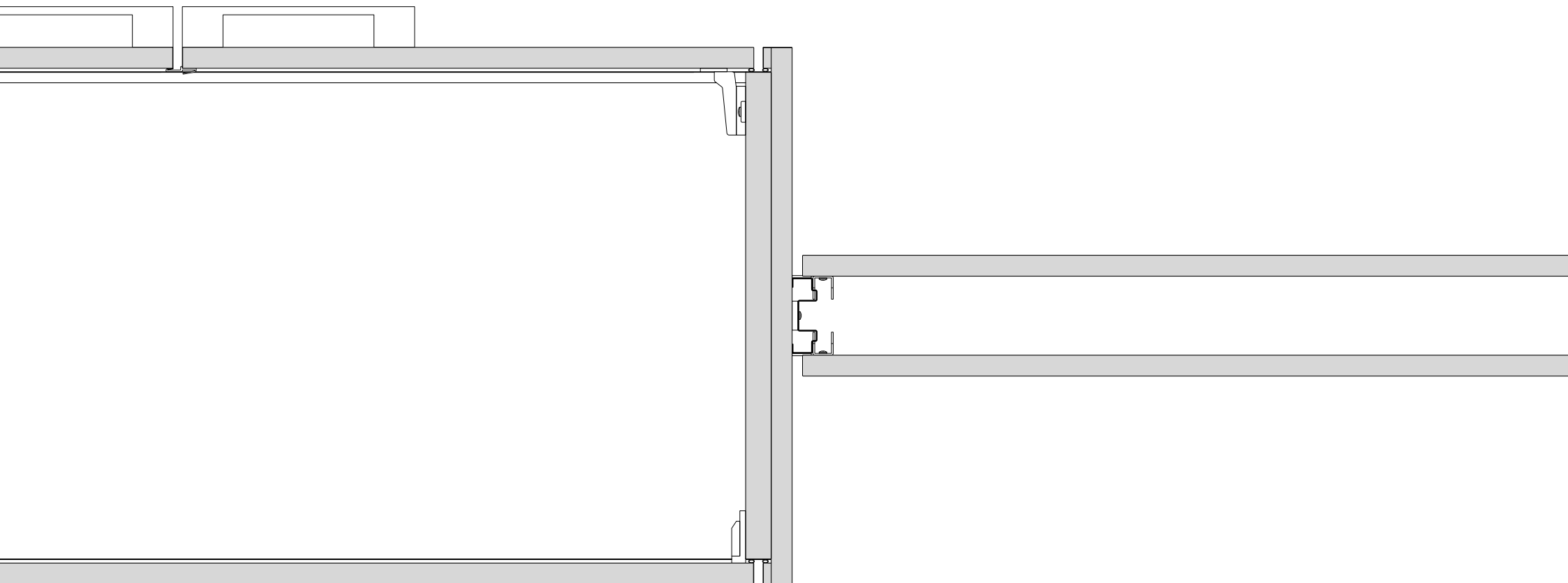

Partenza da contenitore

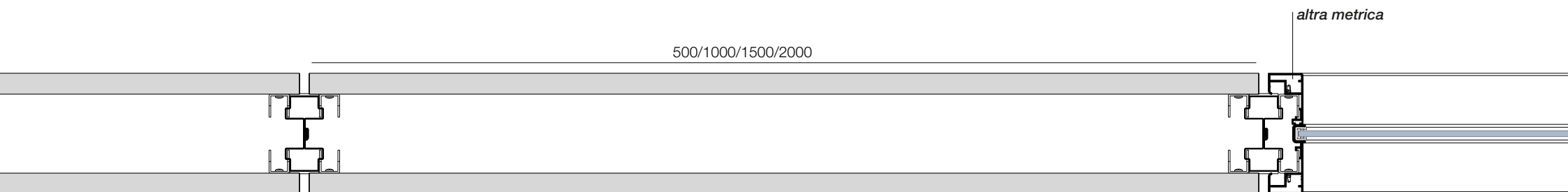

**Conessione
metrica solid - metrica solid**

**Conessione
metrica solid - altra metrica**

Angoli

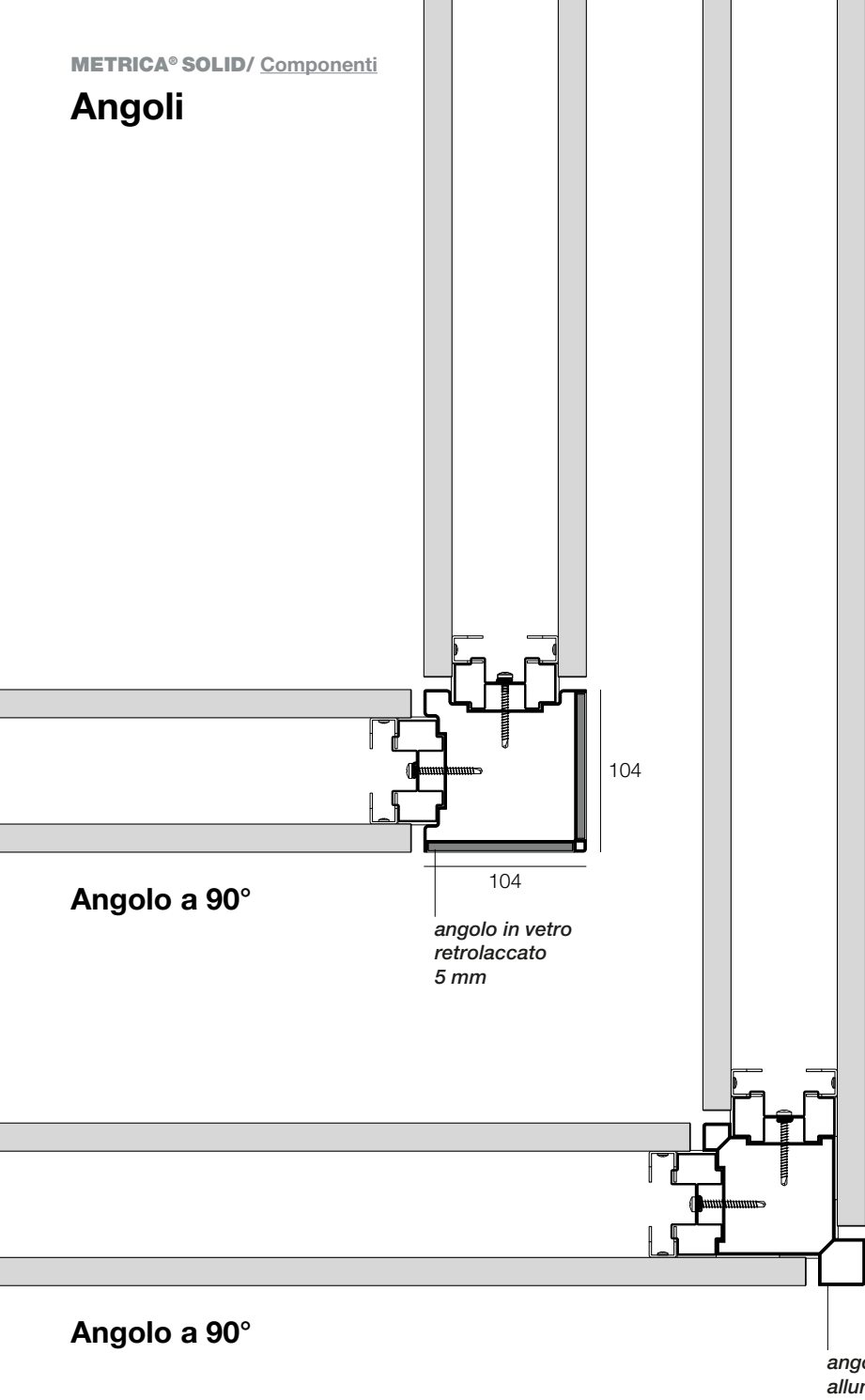

Angolo 2 vie

Angolo variabile

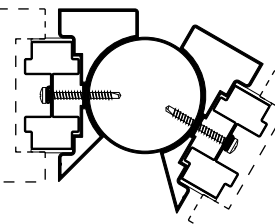
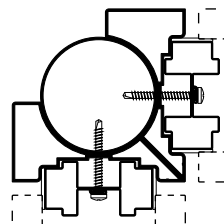

Angolo 3 vie

Angolo 4 vie

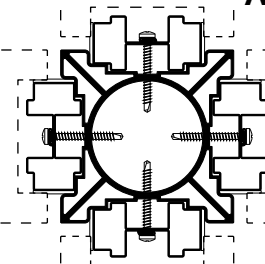
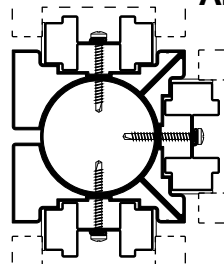

Cablaggio e modulo tecnico della porta a battente



Modulo tecnico

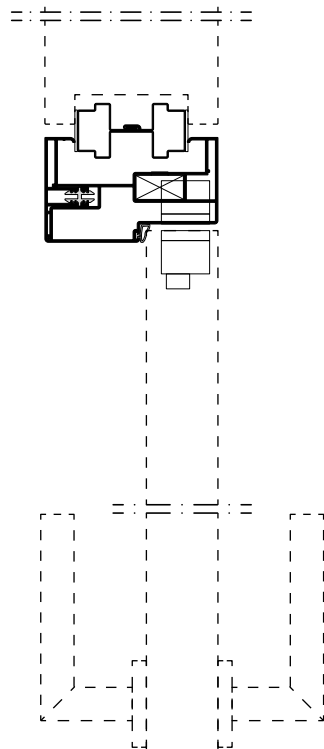
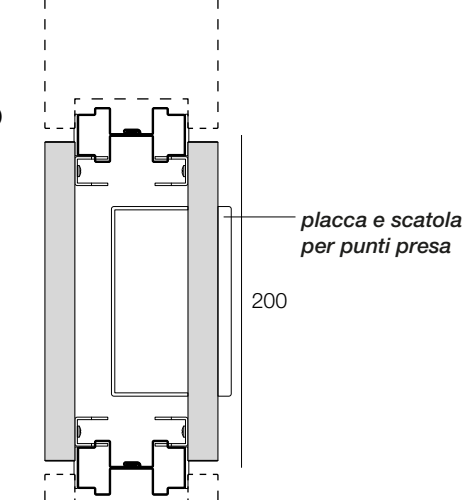

Soluzione di cablaggio

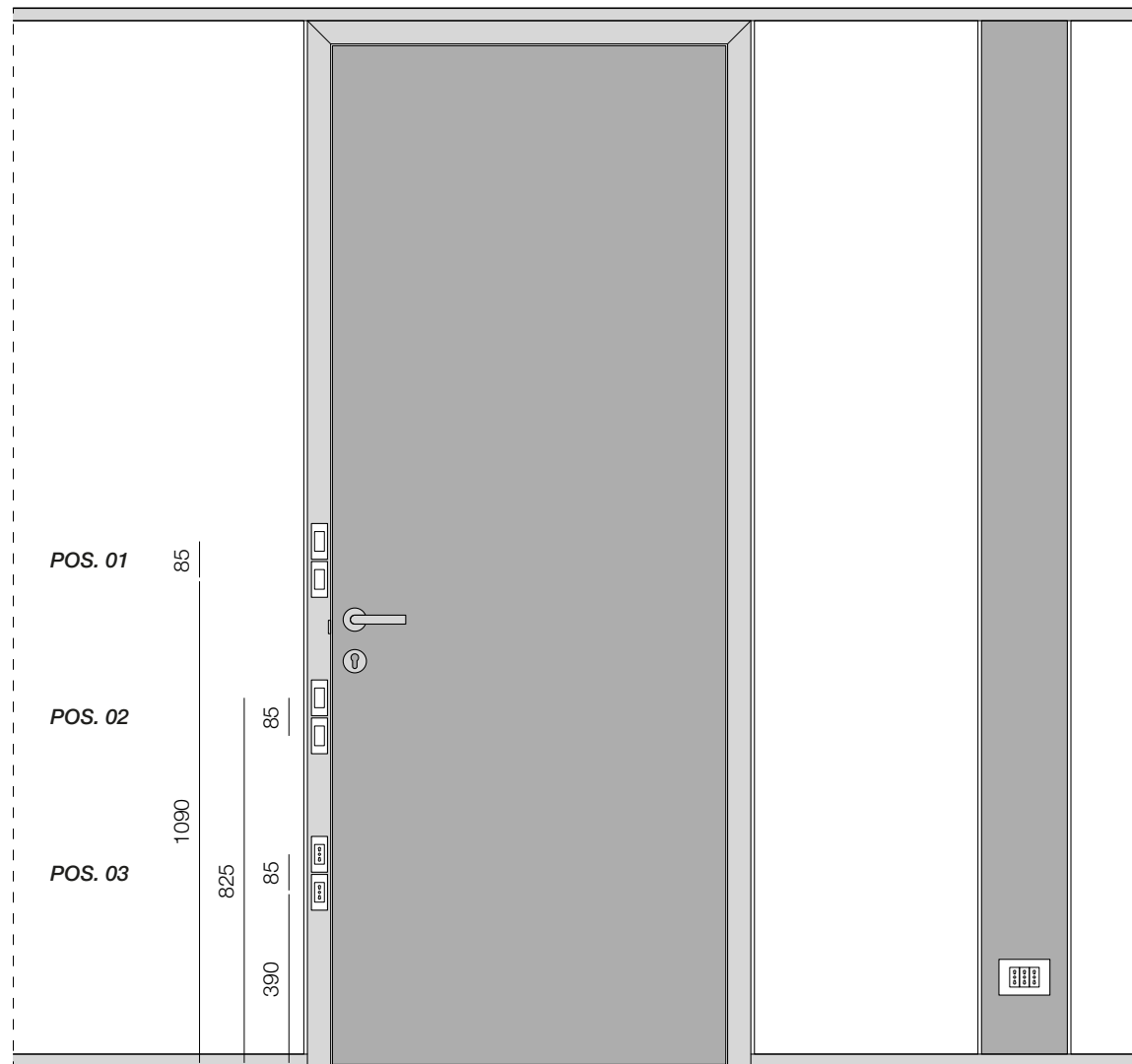
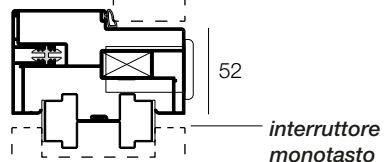

**posizioni possibili di interruttori e prese su telaio porta*

Cablaggio e modulo tecnico della porta scorrevole



Modulo tecnico

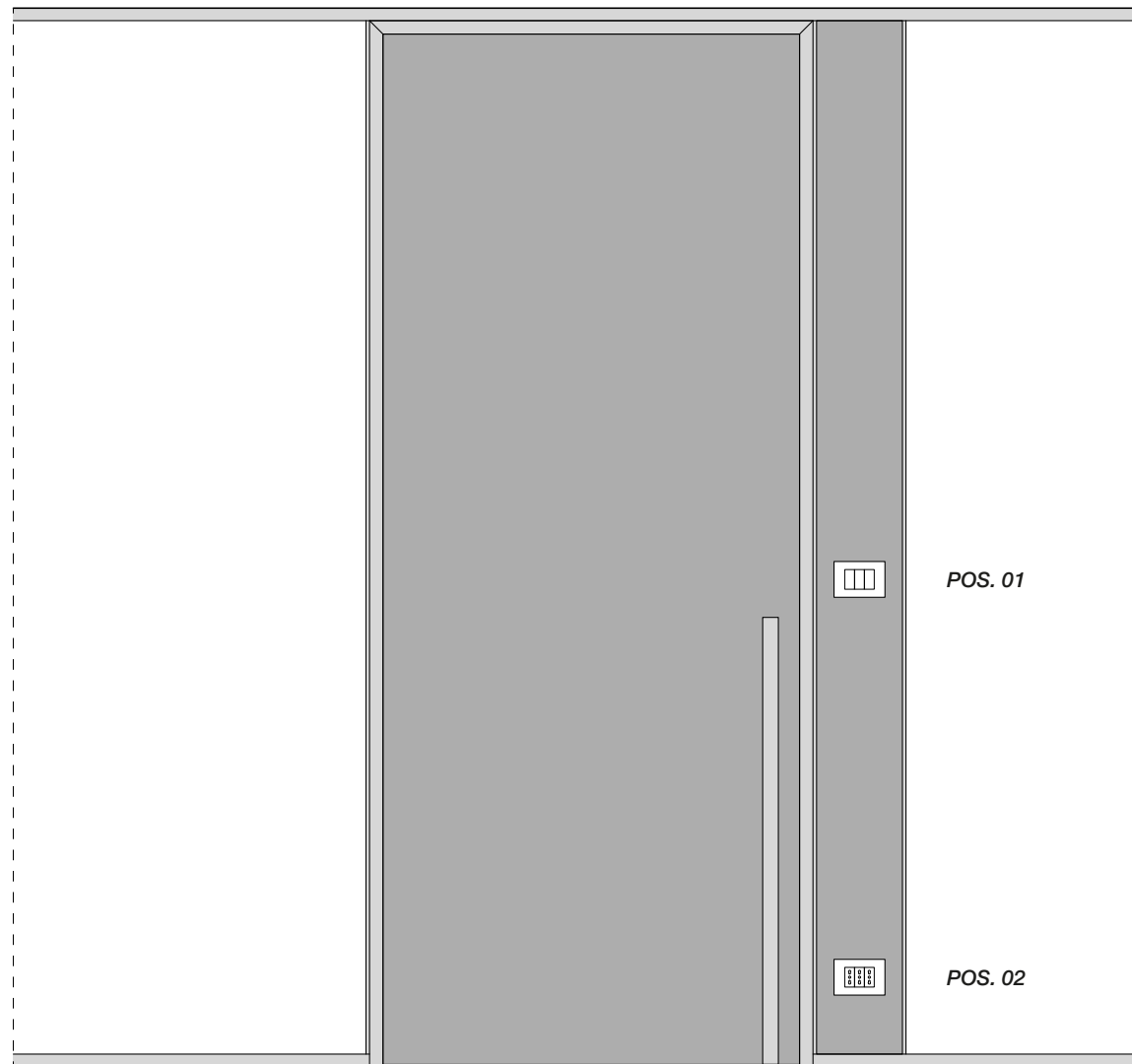
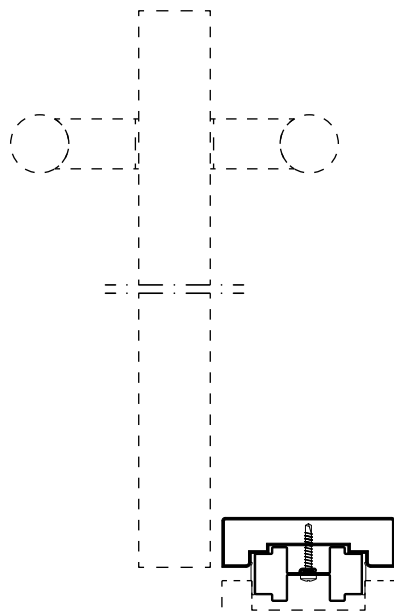
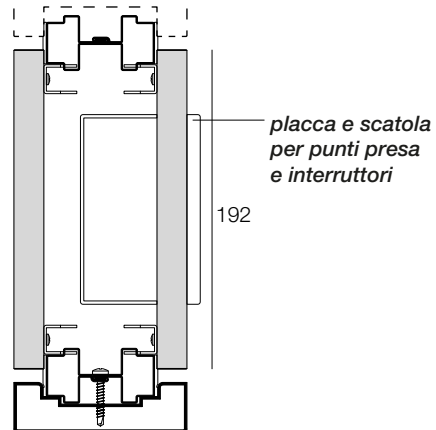

*posizioni possibili di interruttori e prese su modulo tecnico

METRICA® F1

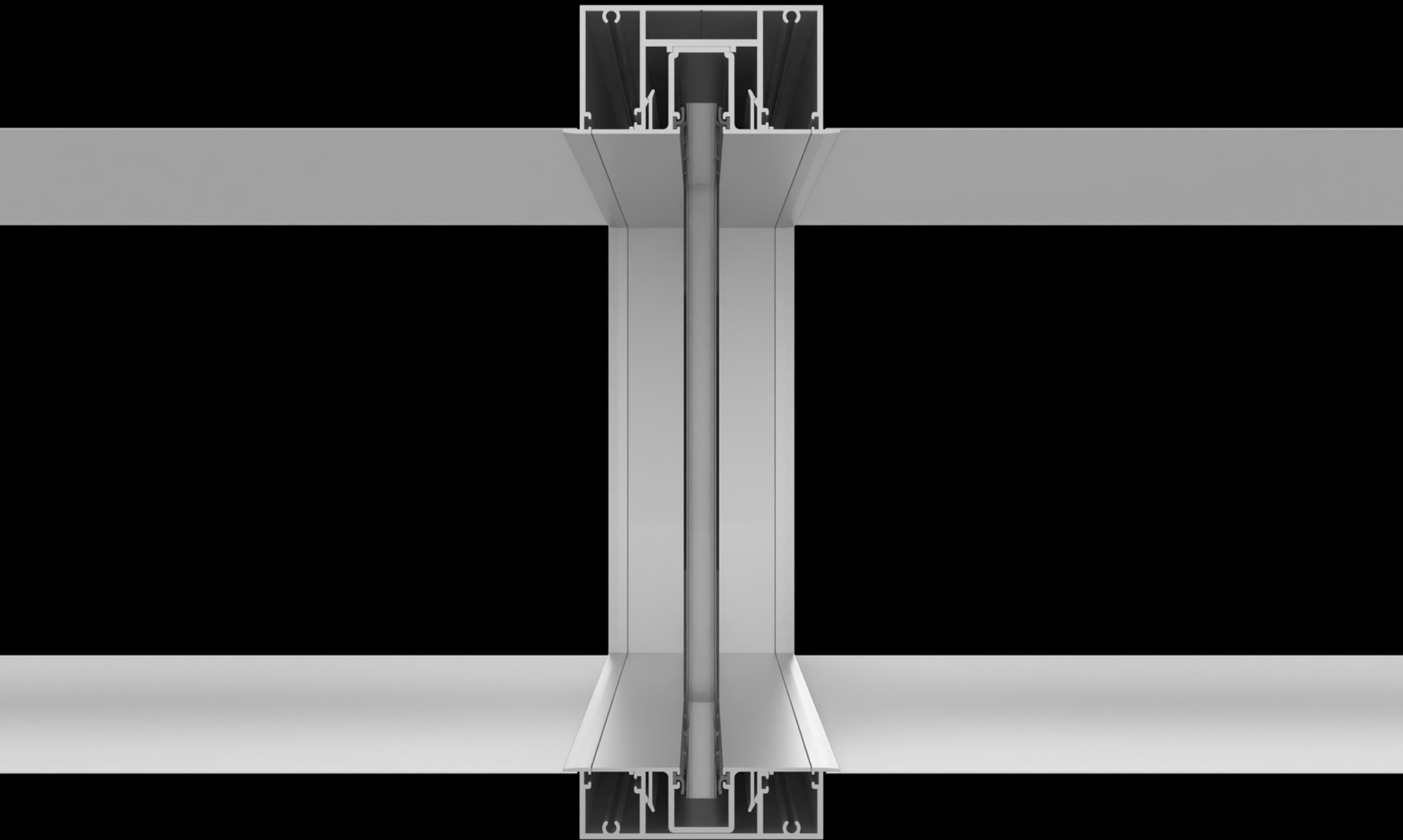



- 01.** Spessore 97 mm
- 02.** Profili incassati a pavimento, a soffitto, angoli e partenze in estruso di alluminio 6060 UNI 9006/1
- 03.** Vetro singolo centrale - spessore 55.1/55.2/66.1/66.2 o temperato 10/12 mm
- 04.** Profili d'angolo fissi e variabili - connessioni 2/3 vie
- 05.** Giunzioni verticali tra elementi vetrati in alluminio, policarbonato e biadesivo trasparente
- 06.** Modulo tecnico
- 07.** 5 versioni di porte battenti - cieche, in vetro temperato e intelaiate



Partenze

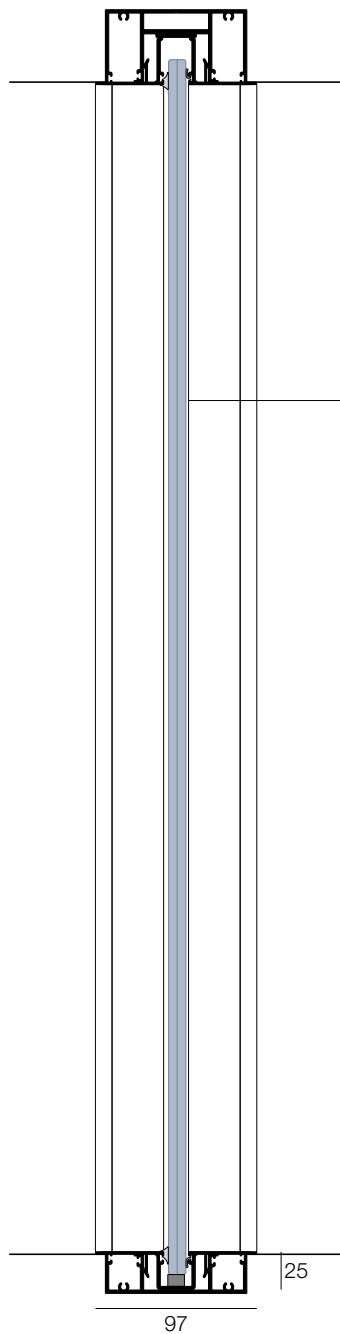

vetro 55.1 stratificato
vetro 55.2 stratificato
vetro 66.1 stratificato
vetro 66.2 stratificato

vetro 10 mm temperato
vetro 12 mm temperato

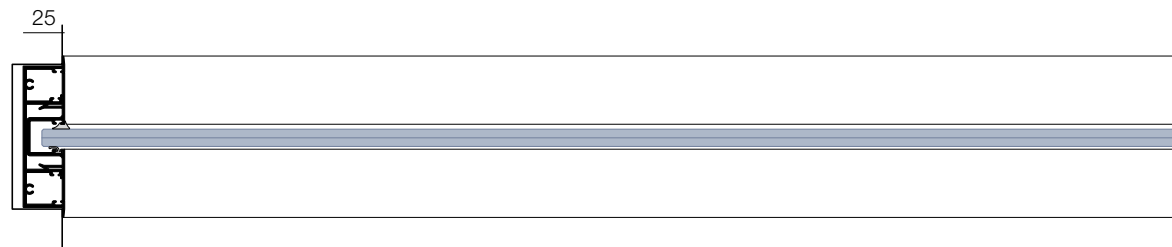

Partenza incassata a parete

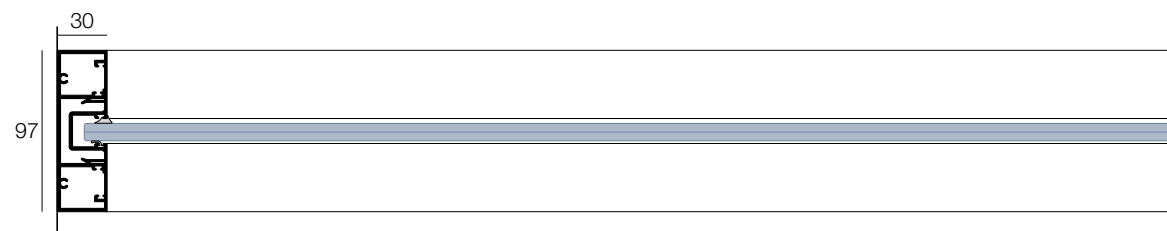

Partenza fissa da parete

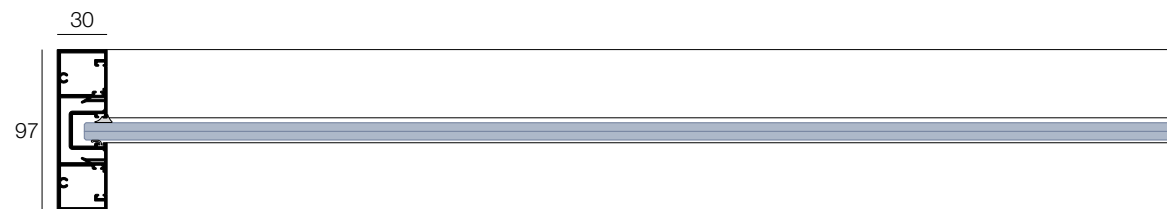

Profilo terminale

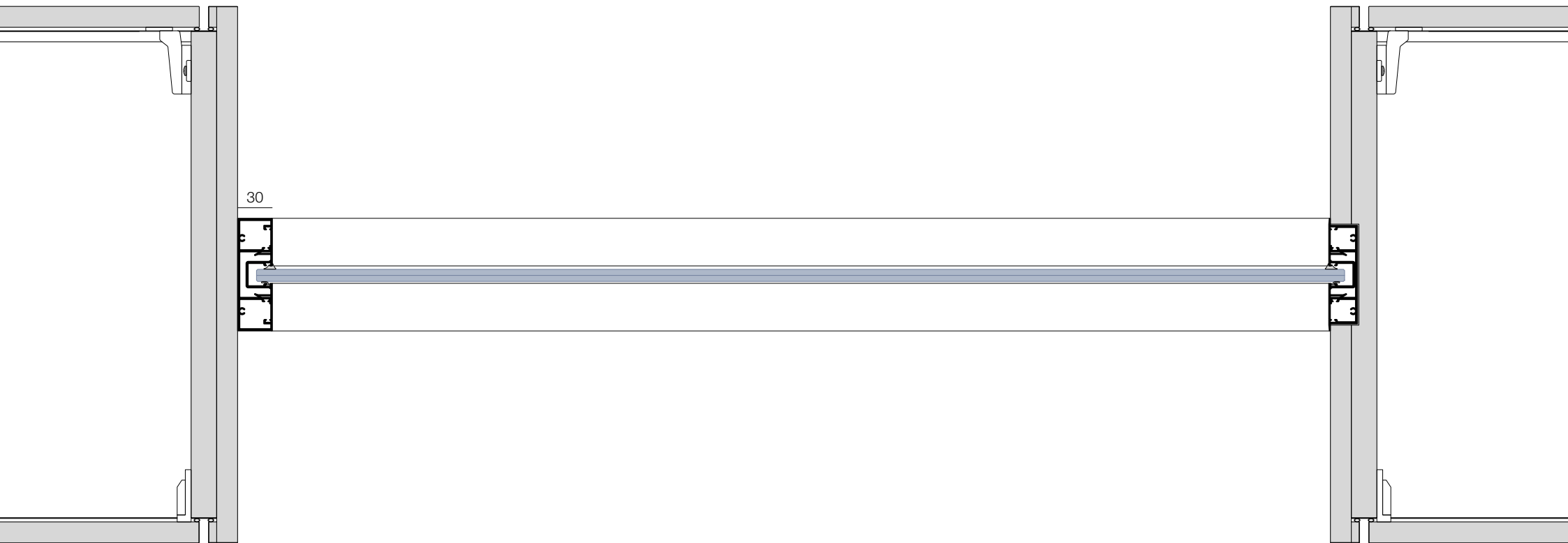

Partenza da contenitore

Partenza da contenitore incassata

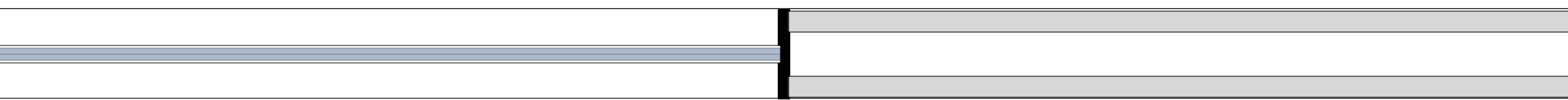

**Connessione in alluminio
metrica f1 - metrica f solid**

variabile

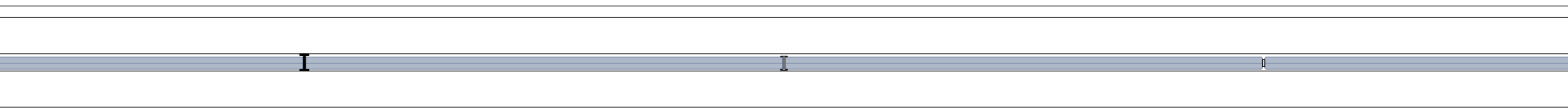

**Connessione
in alluminio**

**Connessione
in policarbonato**

**Connessione
con biadesivo tecnico**

**Connessione a tre vie
in policarbonato**

**Connessione a tre vie
con biadesivo tecnico**

Angoli

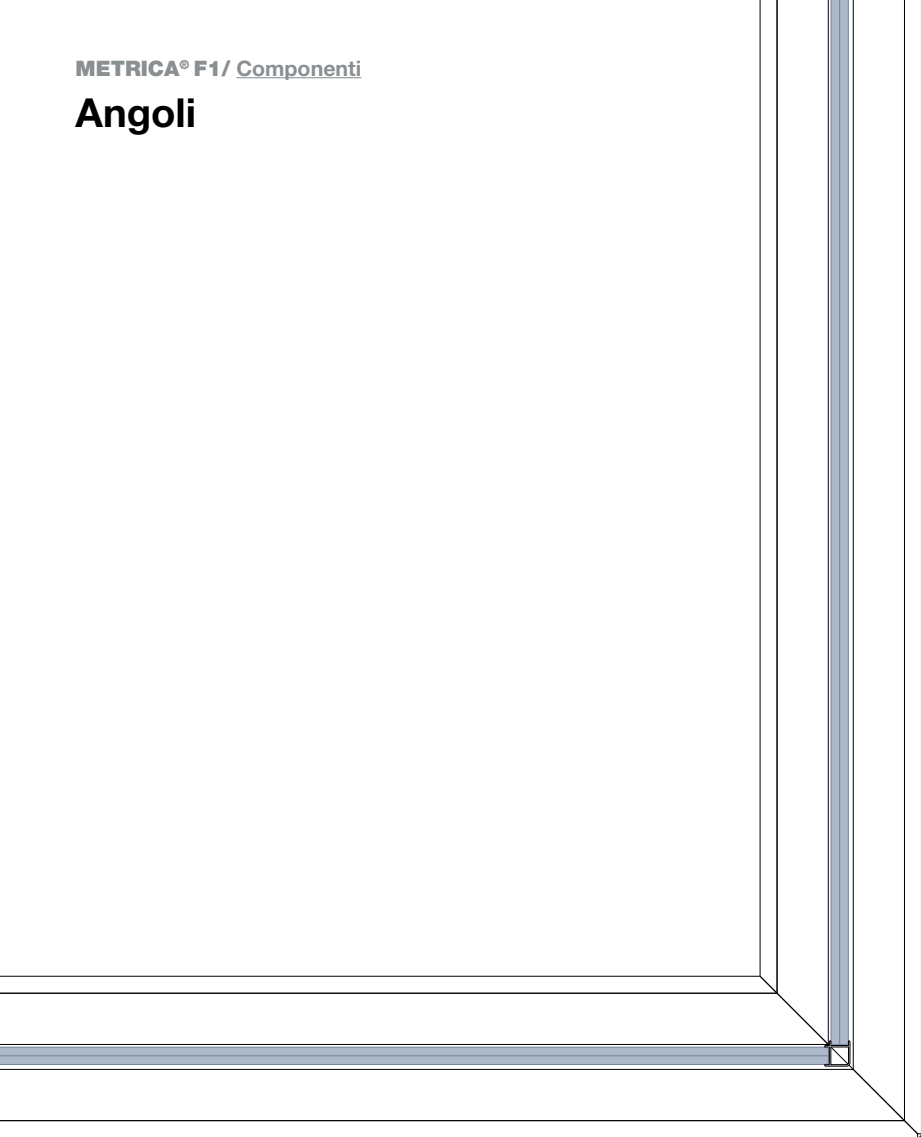

**Angolo a 90°
in policarbonato**

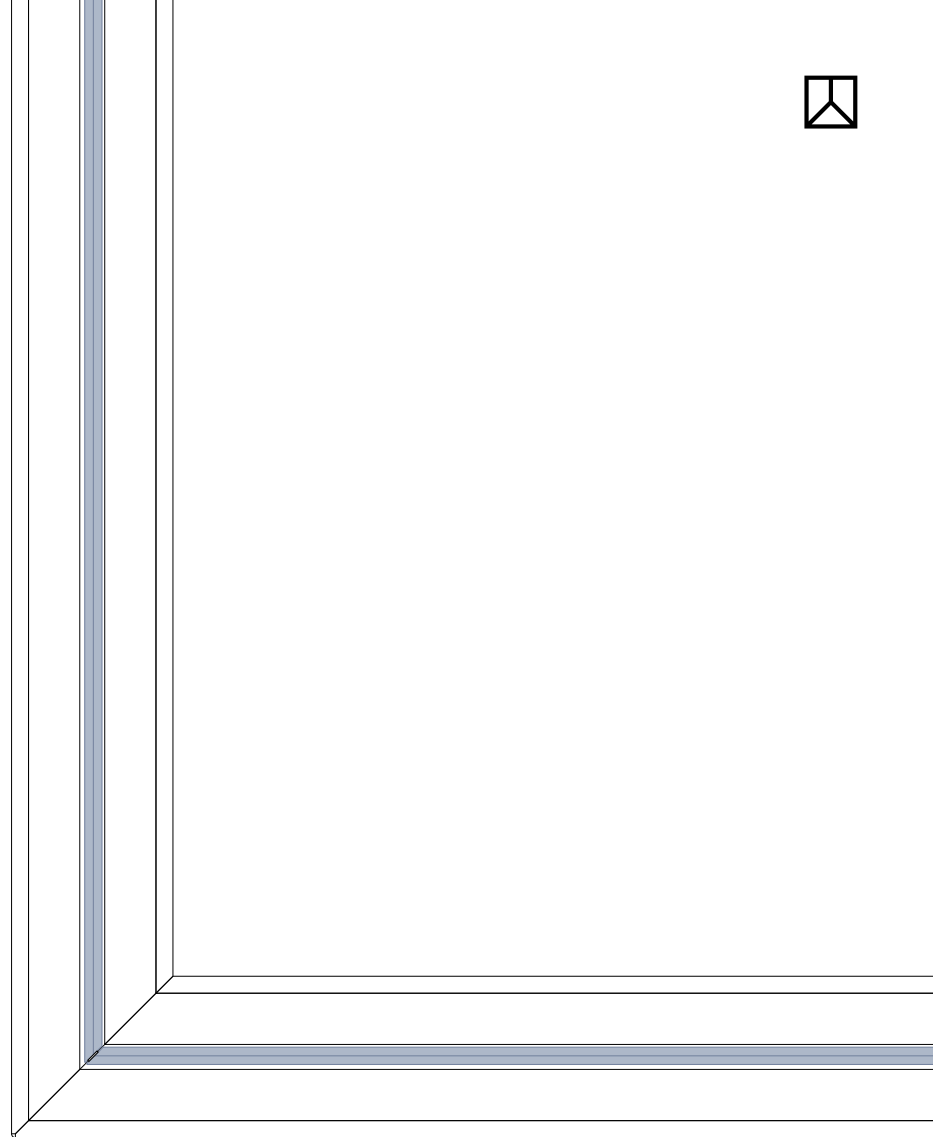

**Angolo a 90°
con biadesivo tecnico**

Modulo tecnico della porta a battente



Modulo tecnico

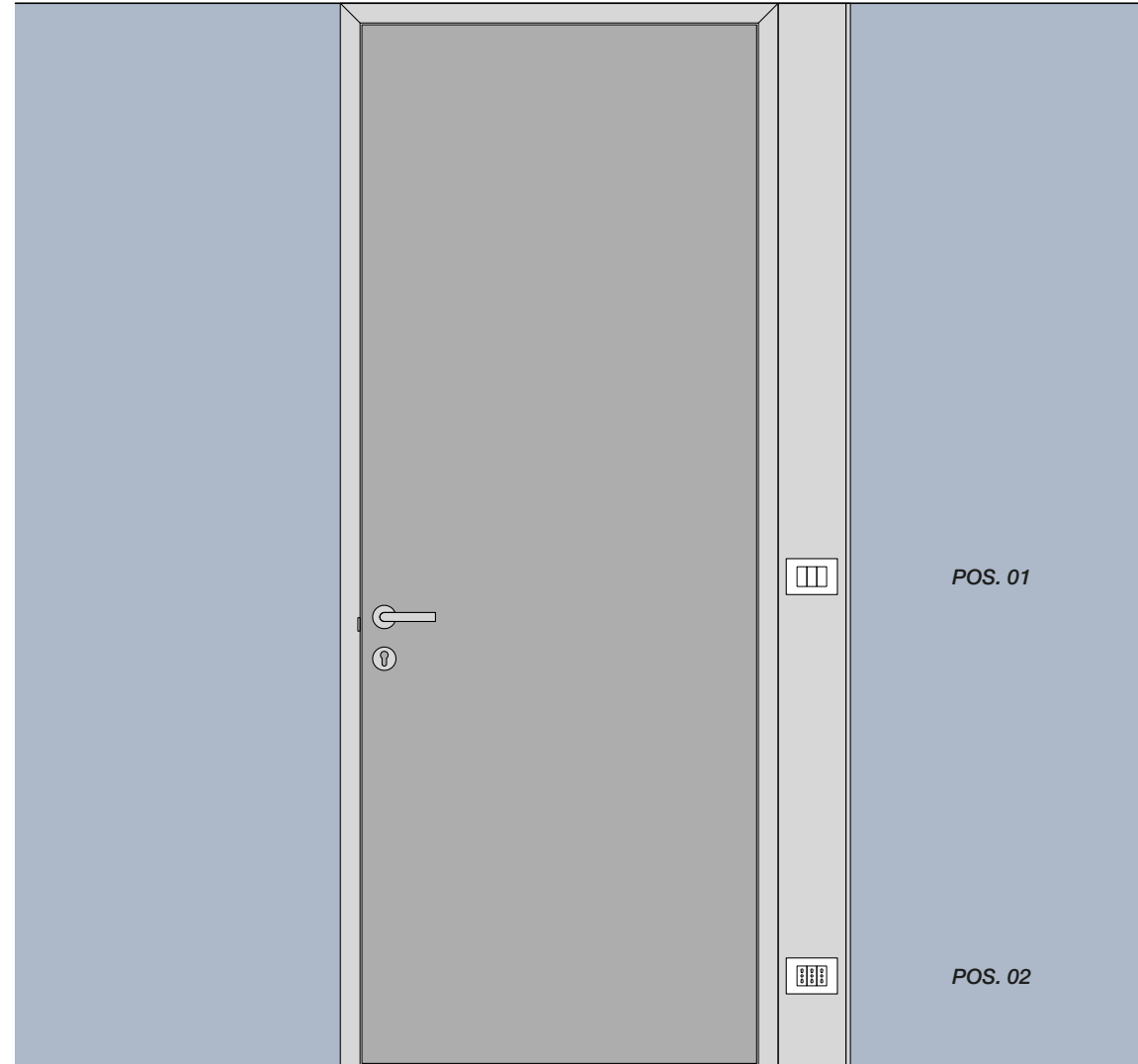
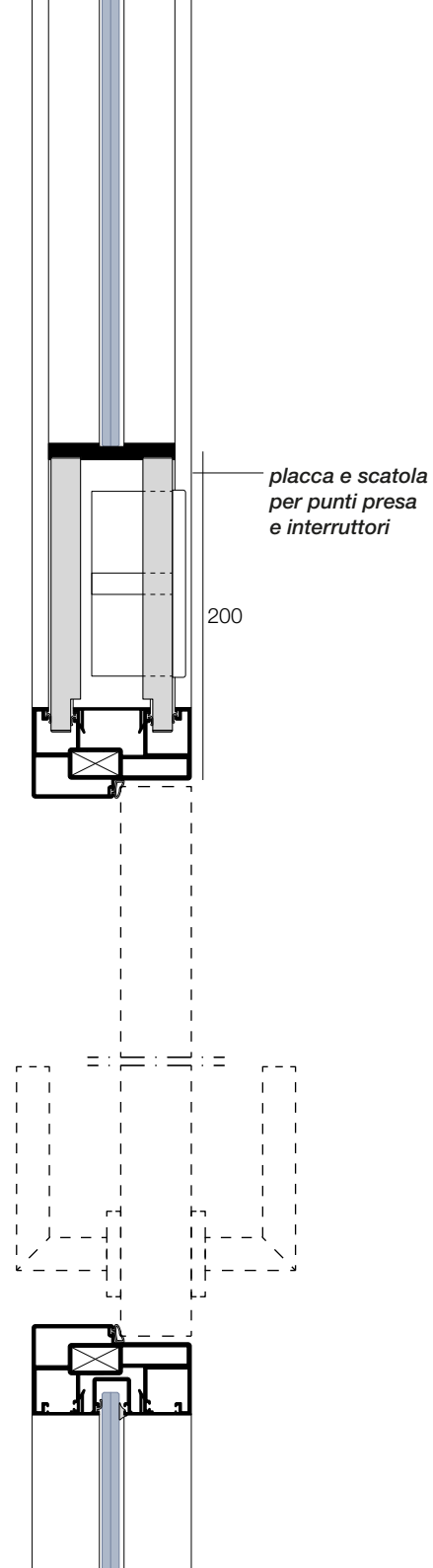

**posizioni possibili di interruttori e prese su modulo tecnico*

METRICA® FA

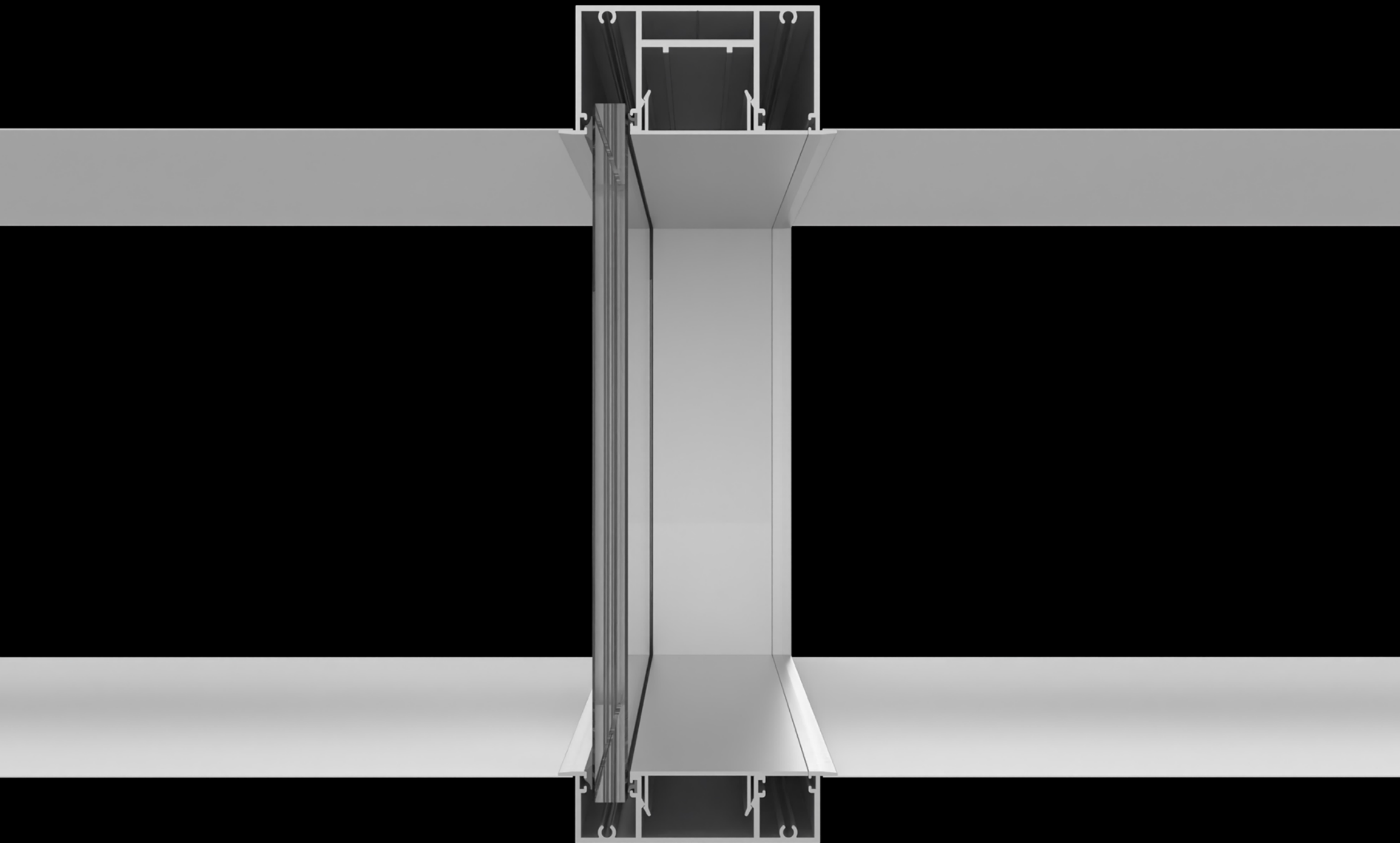



- 01.** Spessore 97 mm
- 02.** Profili incassati a pavimento, a soffitto, angoli e partenze in estruso di alluminio 6060 UNI 9006/1
- 03.** Vetro singolo asimmetrico - spessore 55.1/55.2/66.1/66.2 o temperato 10/12 mm
- 04.** Profili d'angolo fissi e variabili - connessioni 2/3 vie
- 05.** Giunzioni verticali tra elementi vetrati in alluminio, policarbonato e biadesivo trasparente
- 06.** Modulo tecnico
- 07.** 5 versioni di porte battenti - cieche, in vetro temperato e intelaiate



Partenze

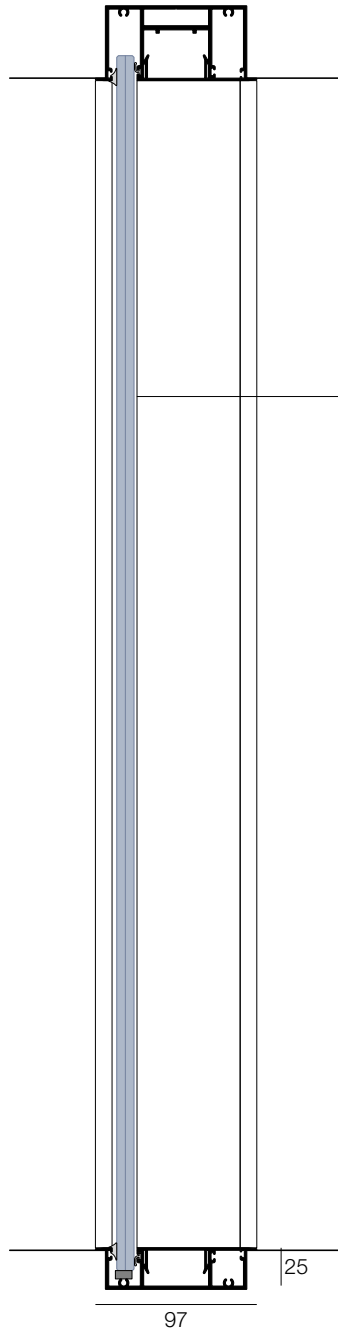

vetro 55.1 stratificato
vetro 55.2 stratificato
vetro 66.1 stratificato
vetro 66.2 stratificato

vetro 10 mm temperato
vetro 12 mm temperato

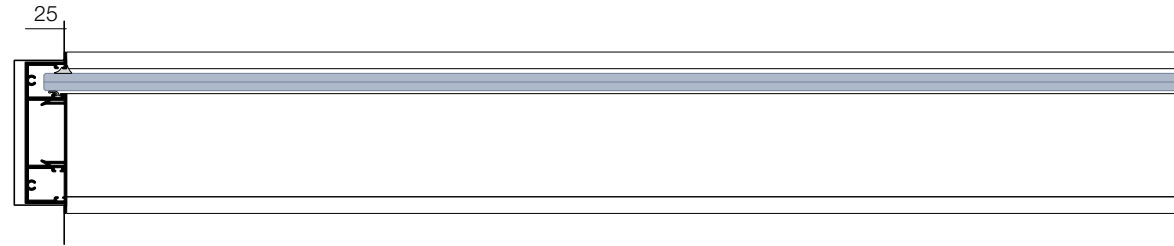

Partenza incassata a parete

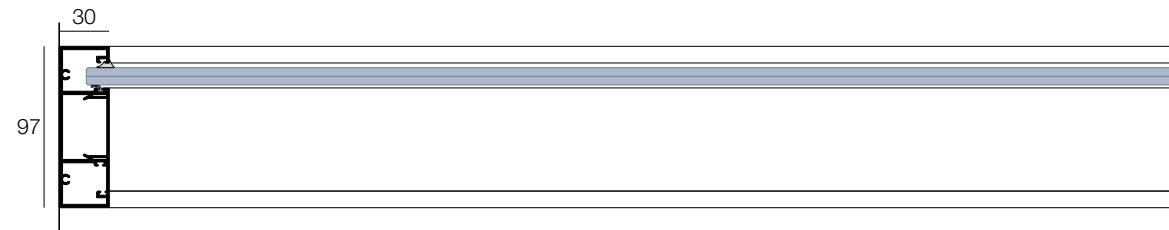

Partenza fissa da parete

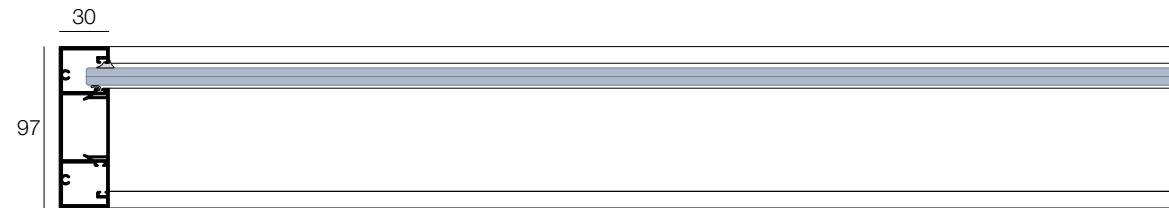

Profilo terminale



Partenza da contenitore

Partenza da contenitore incassata

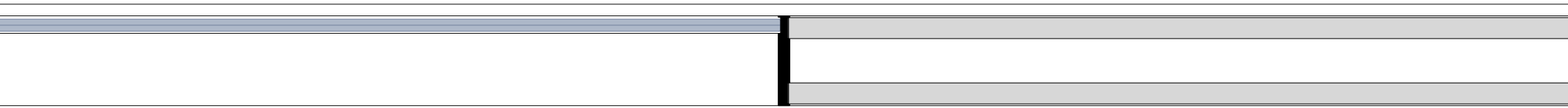

**Connessione in alluminio
metrica fa - metrica f solid**

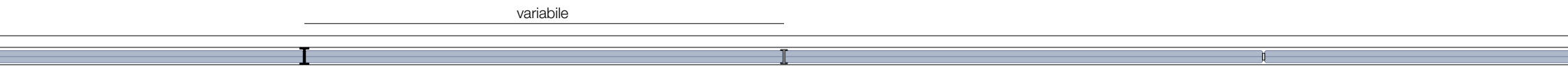

**Connessione
in alluminio**

**Connessione
in policarbonato**

**Connessione
con biadesivo tecnico**

Angoli

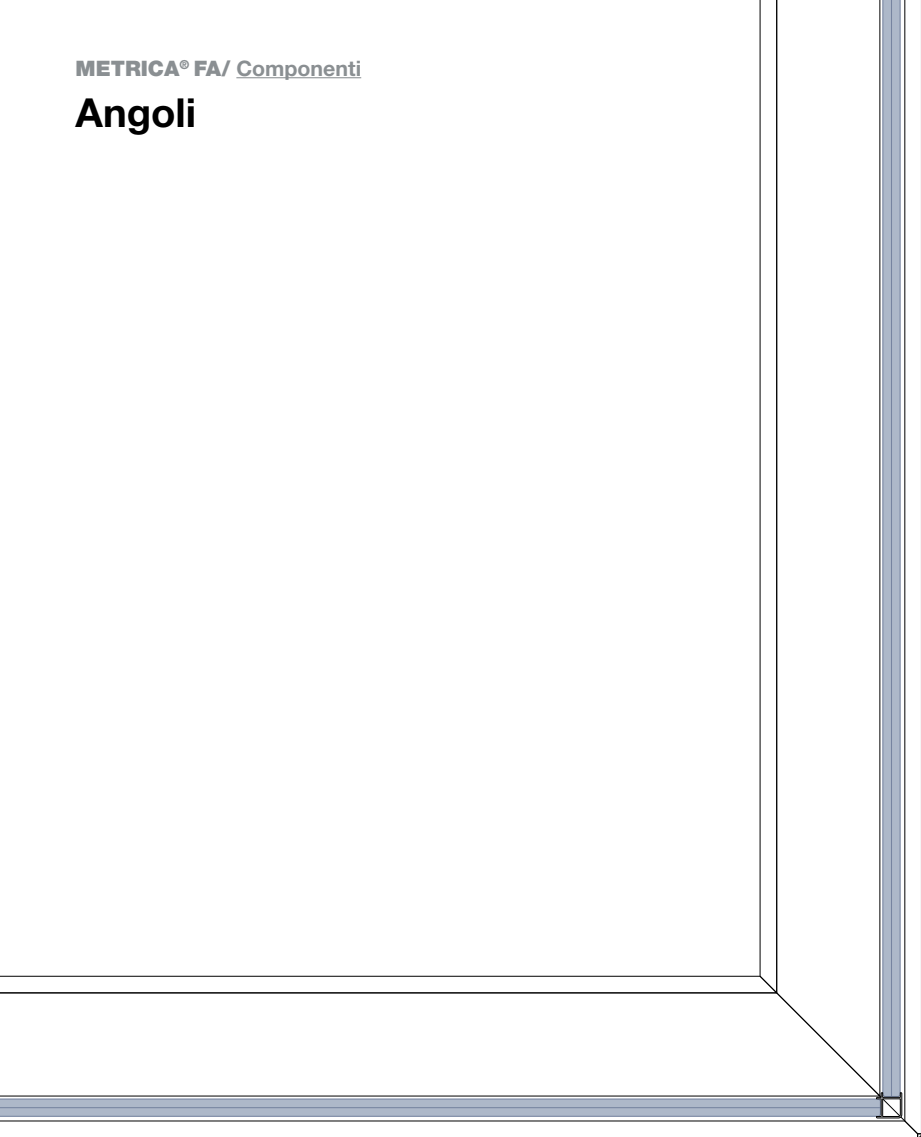

**Angolo a 90°
in policarbonato**

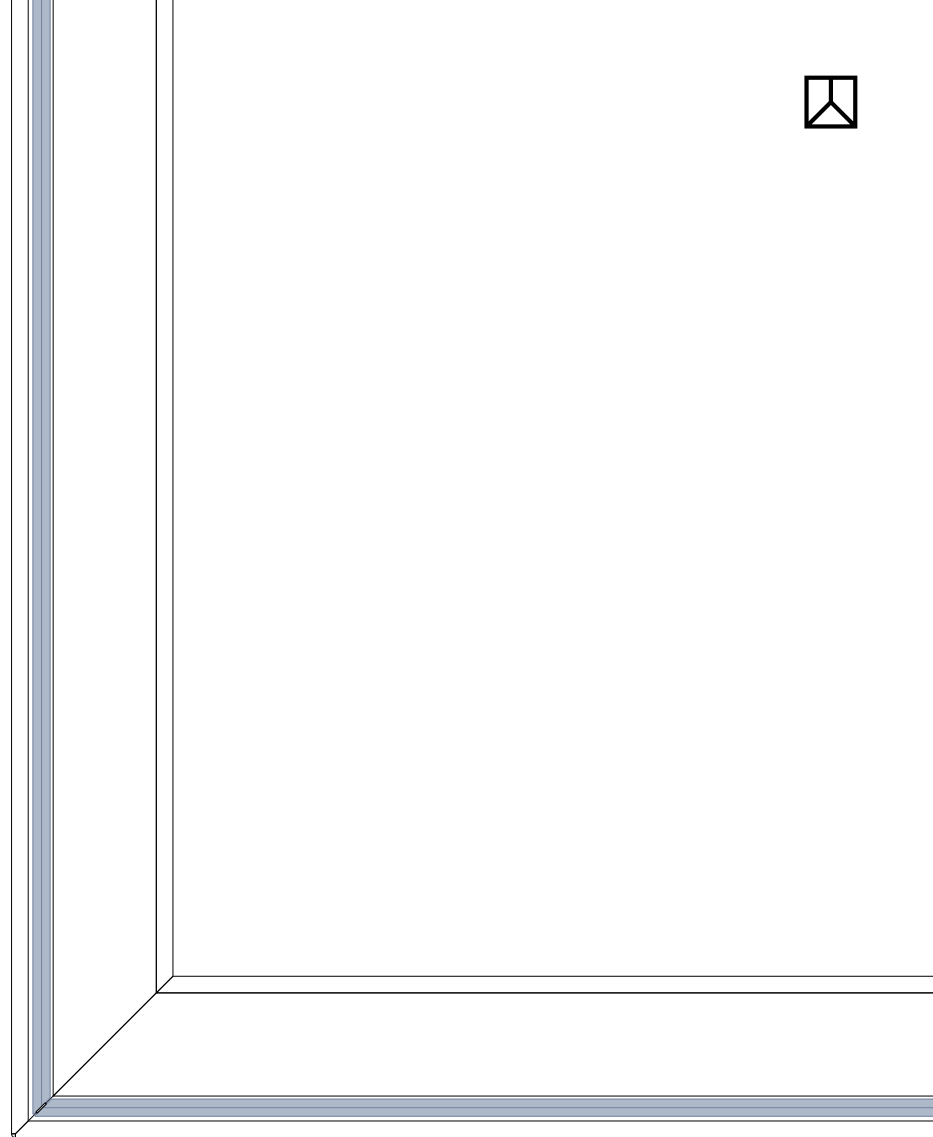

**Angolo a 90°
con biadesivo tecnico**

Modulo tecnico della porta a battente



Modulo tecnico

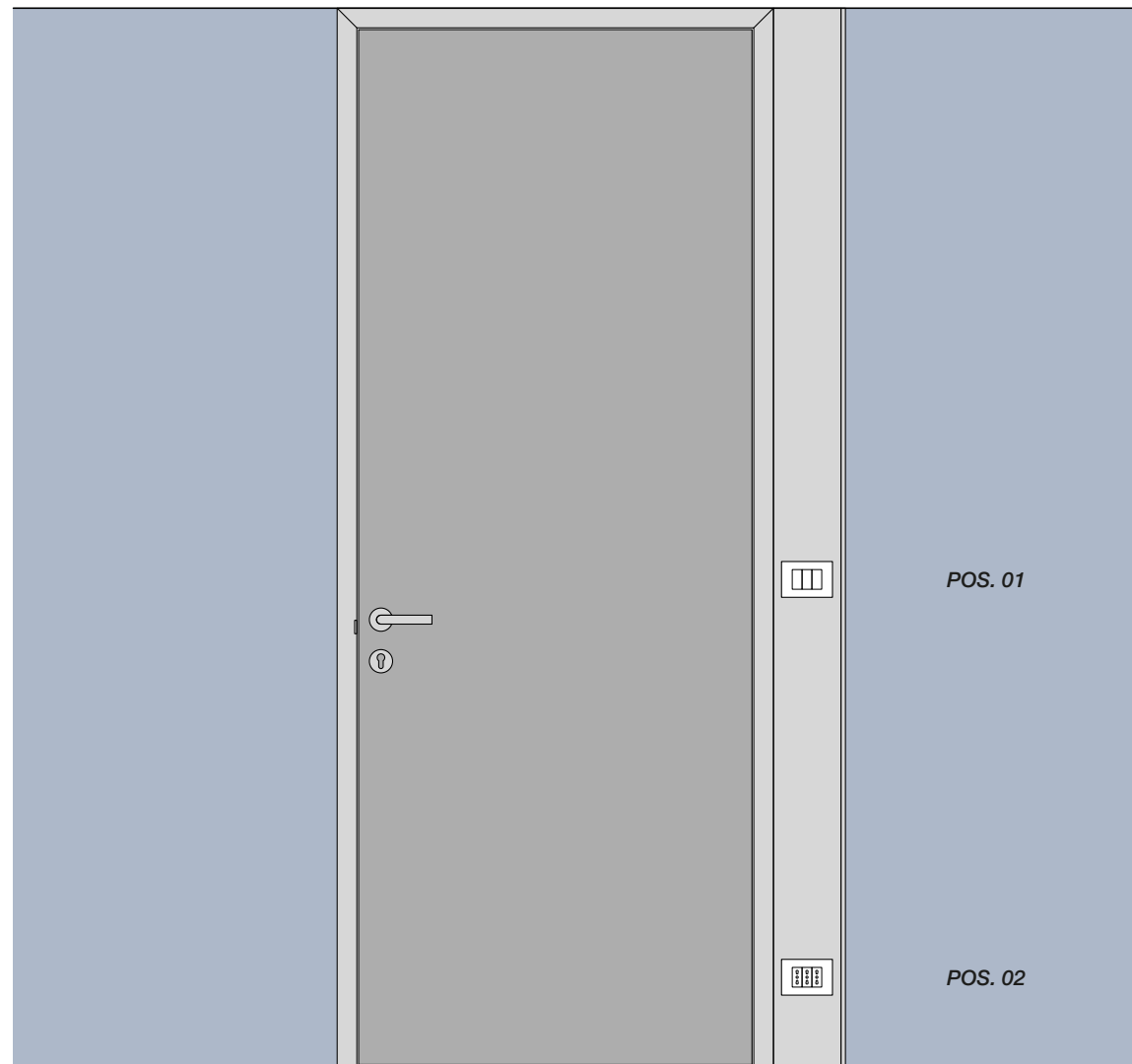
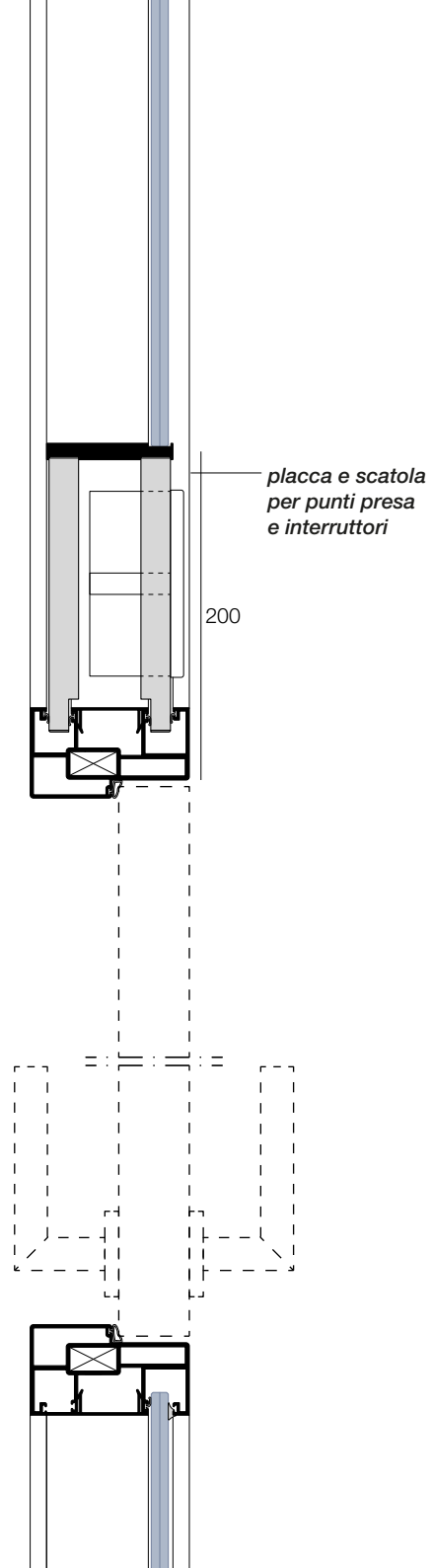

**posizioni possibili di interruttori e prese su modulo tecnico*

METRICA® F2

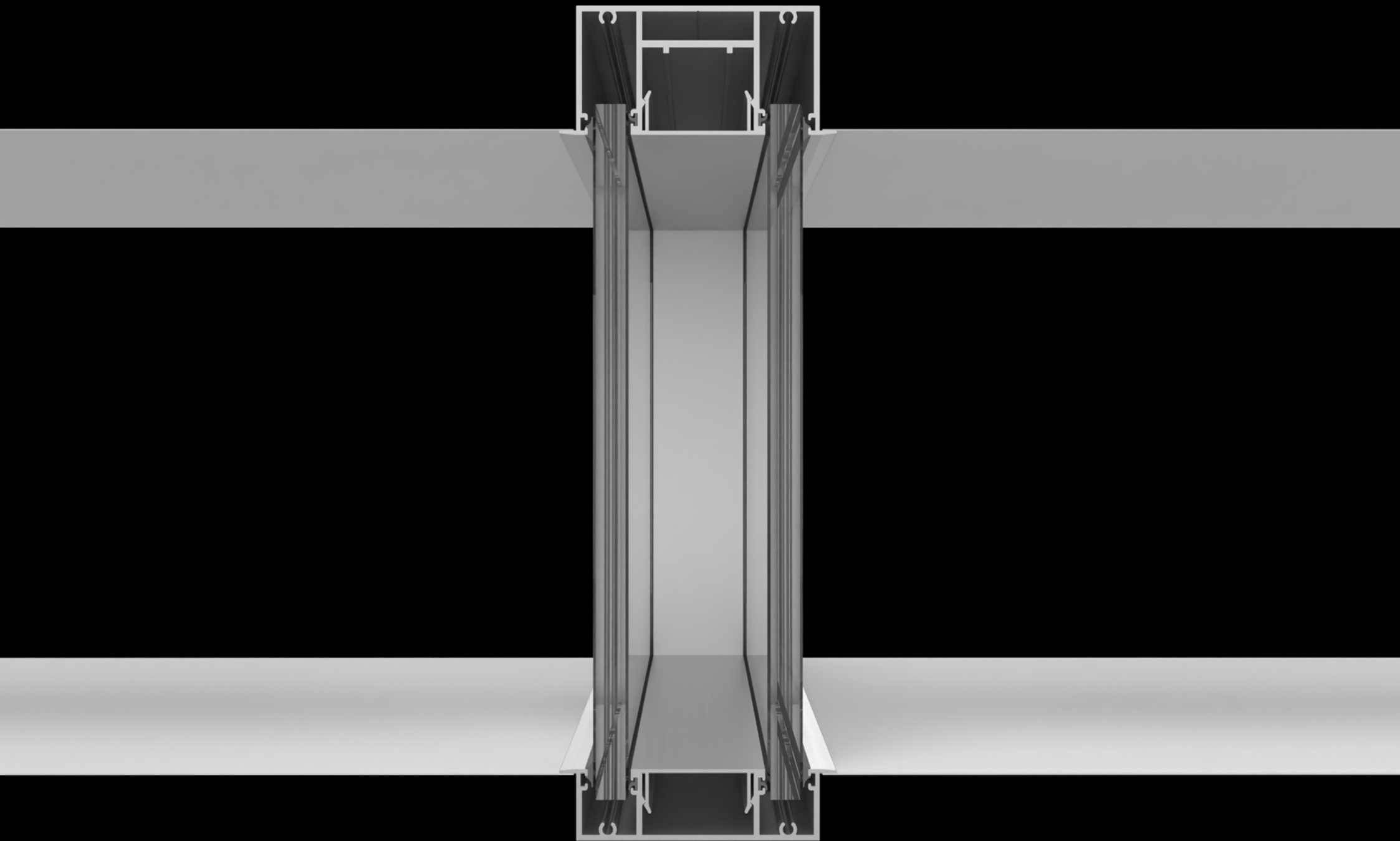



- 01.** Spessore 97 mm
- 02.** Profili incassati a pavimento, a soffitto, angoli e partenze in estruso di alluminio 6060 UNI 9006/1
- 03.** Doppio vetro intelaiato - spessore 55.1/55.2/66.1/66.2 o temperato 10/12 mm
- 04.** Profili d'angolo fissi e variabili - connessioni 2/3 vie
- 05.** Giunzioni verticali tra elementi vetrati in alluminio, policarbonato e biadesivo trasparente
- 06.** Modulo tecnico
- 07.** 5 versioni di porte battenti - cieche, in vetro temperato e intelaiate
- 08.** 1 versione di porta scorrevole interna - intelaiata



Partenze

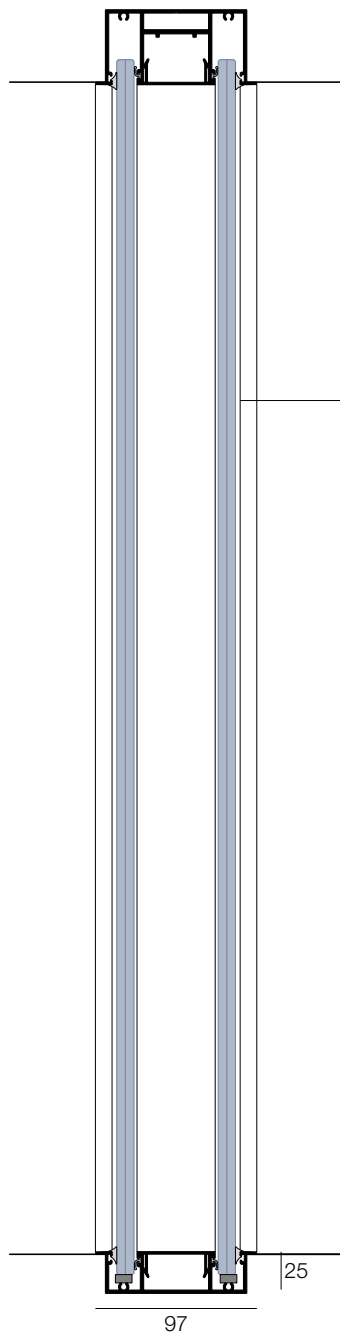

*doppio vetro 55.1 stratificato
doppio vetro 55.2 stratificato
doppio vetro 66.1 stratificato
doppio vetro 66.2 stratificato*

*doppio vetro 10 mm temperato
doppio vetro 12 mm temperato*

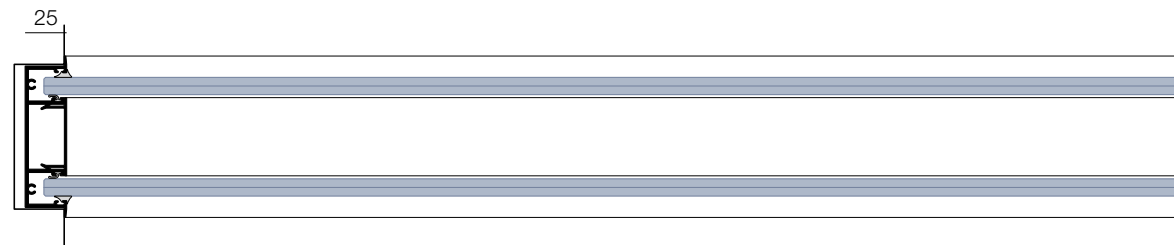

Partenza incassata a parete

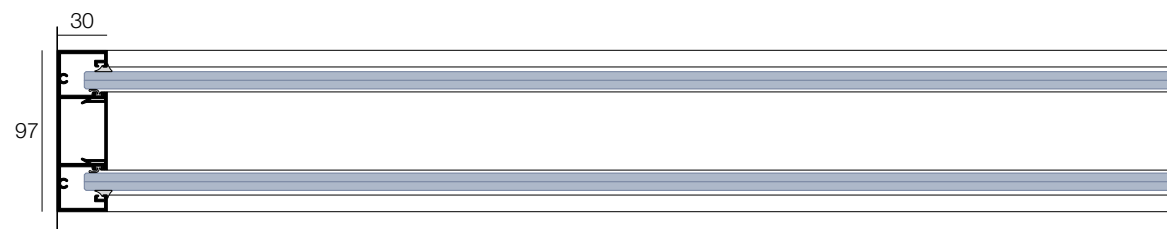

Partenza fissa da parete

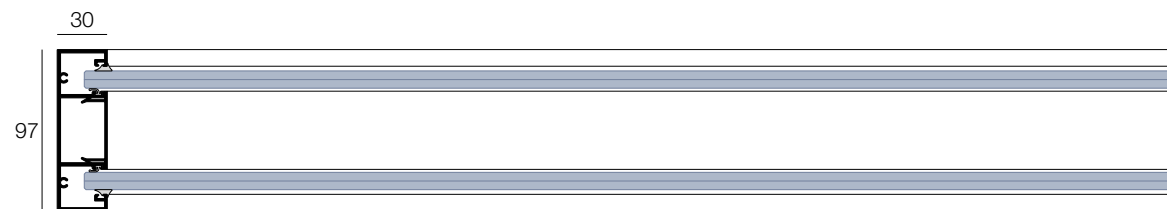

Profilo terminale



Partenza da contenitore

Partenza da contenitore incassata

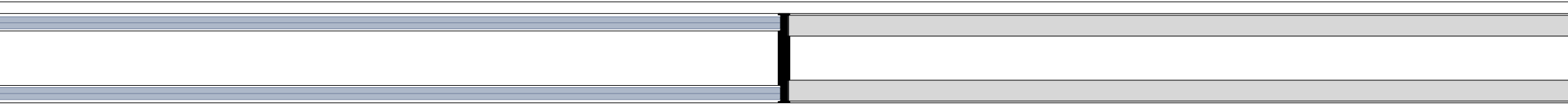

**Connessione in alluminio
metrica f2 - metrica f solid**

variabile

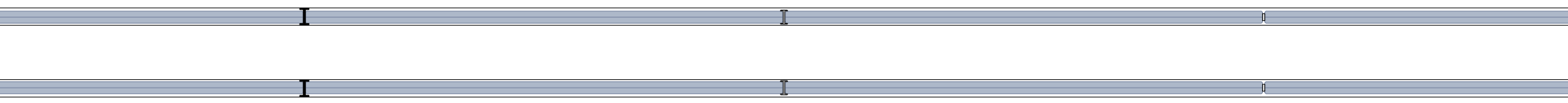

**Connessione
in alluminio**

**Connessione
in policarbonato**

**Connessione
con biadesivo tecnico**

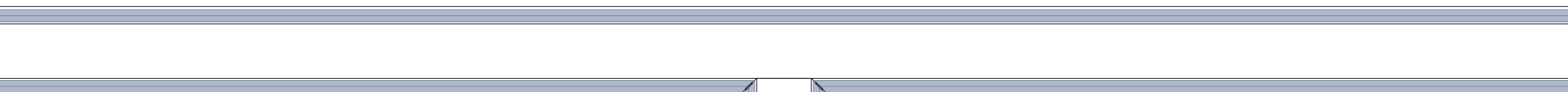

**Connessione a tre vie
con biadesivo tecnico**

Angoli

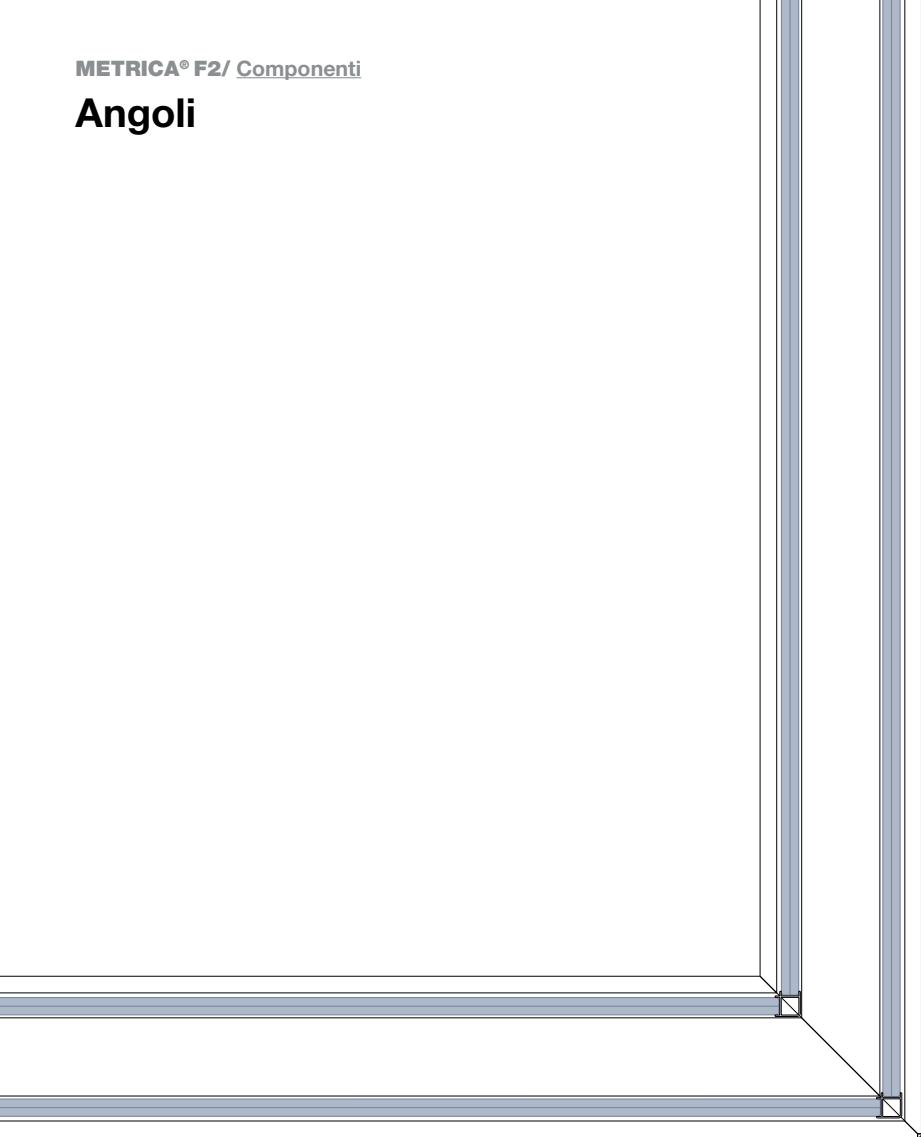

**Angolo a 90°
in policarbonato**

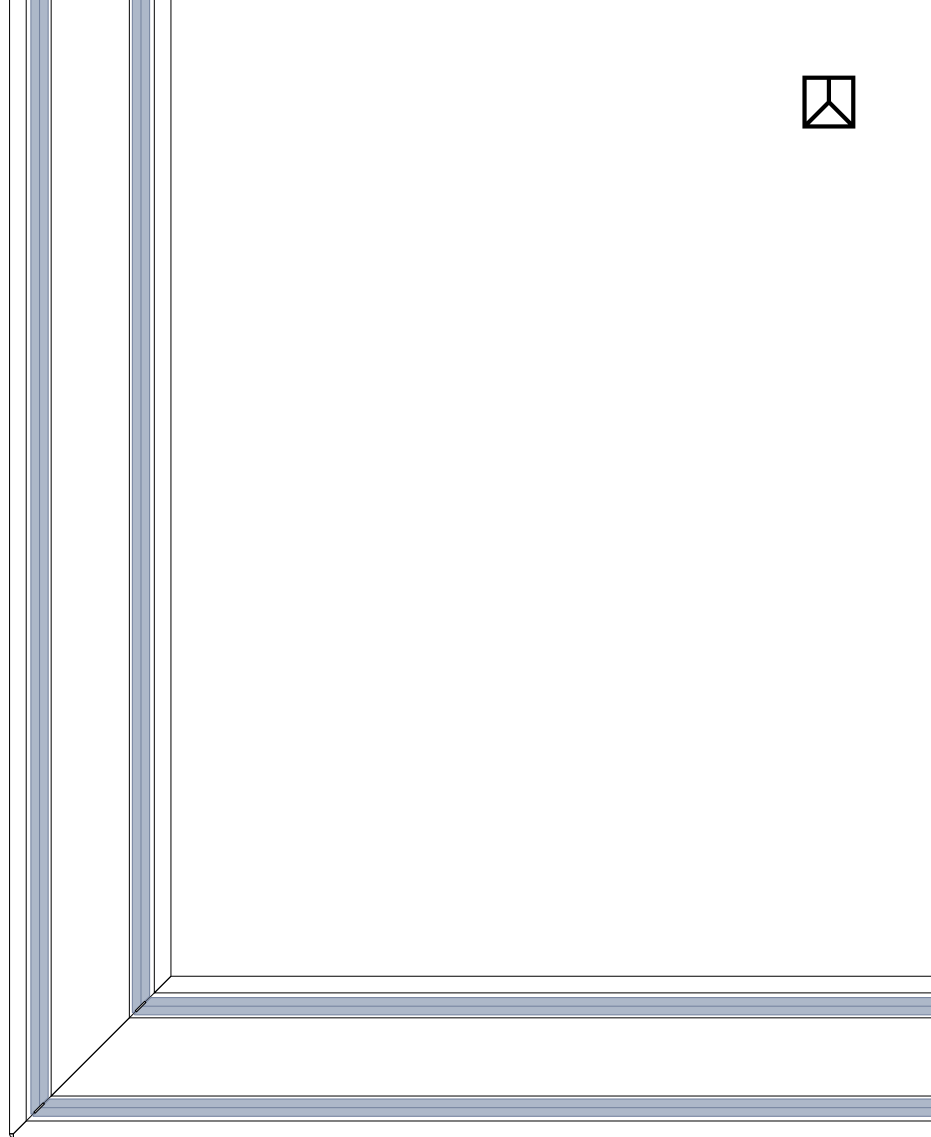

**Angolo a 90°
con biadesivo**

Modulo tecnico della porta a battente



Modulo tecnico

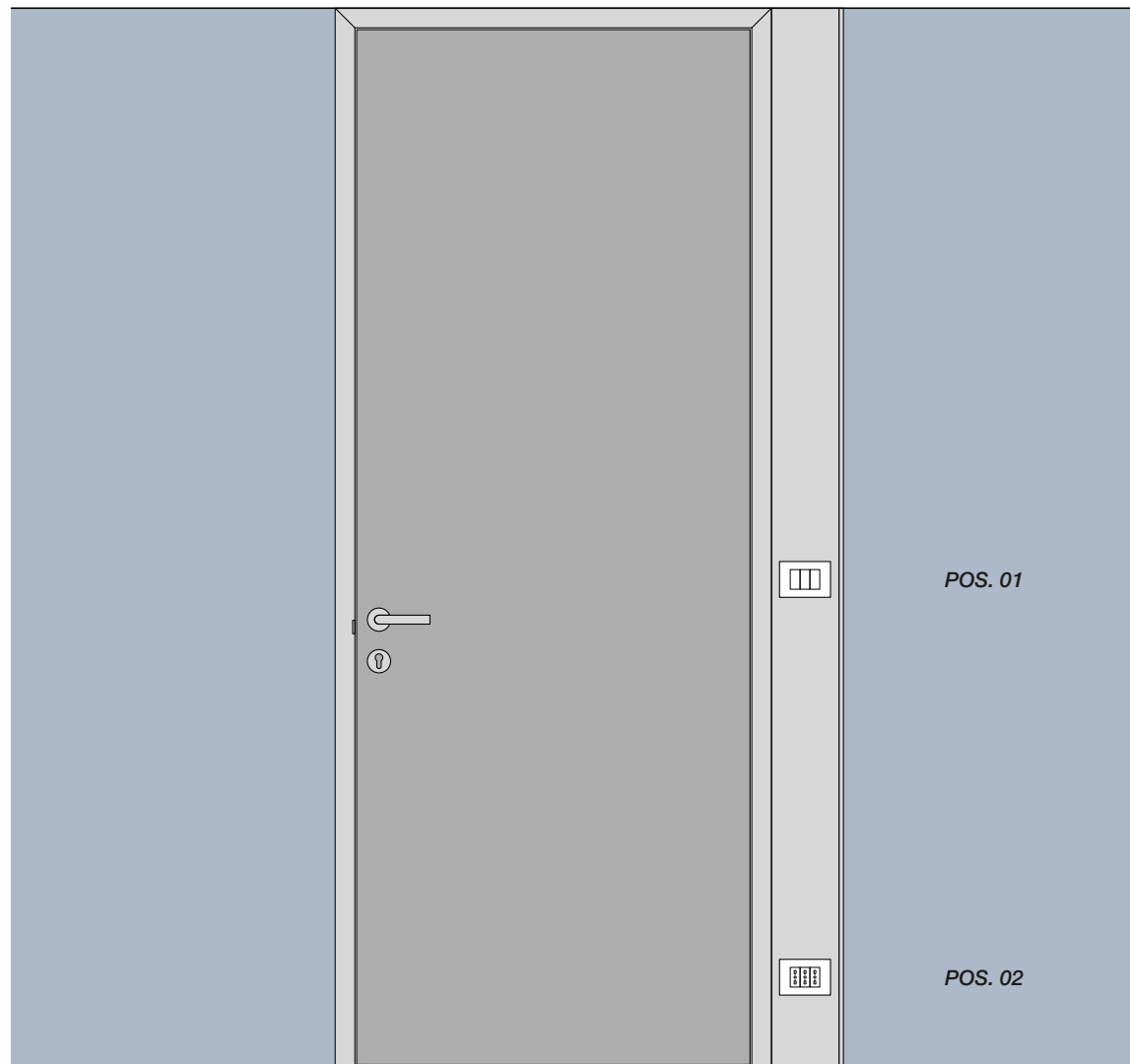
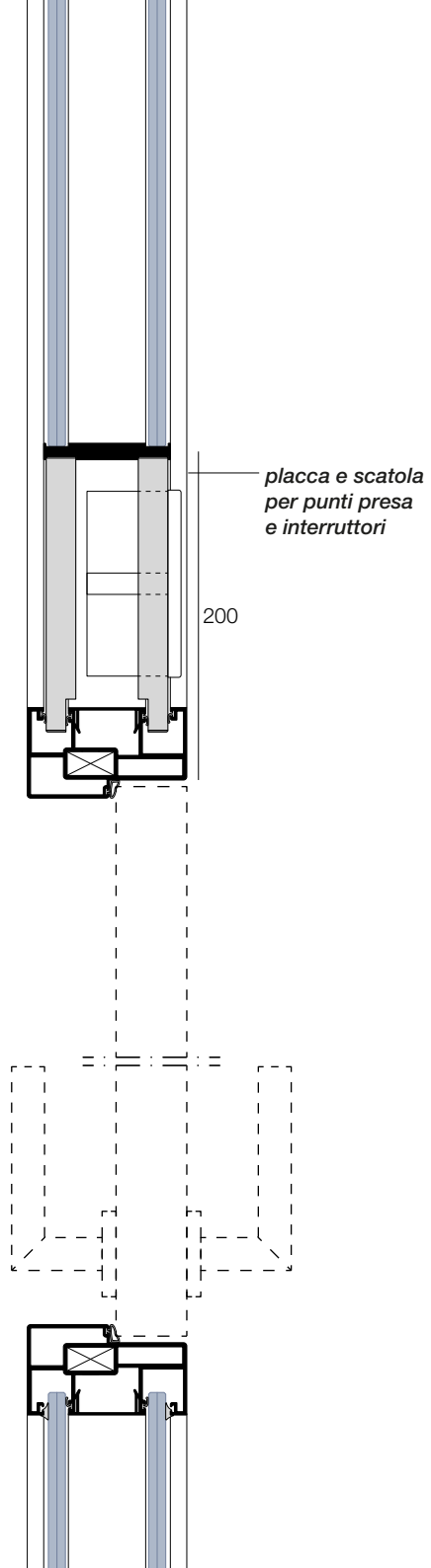

**posizioni possibili di interruttori e prese su modulo tecnico*

METRICA[®] F SOLID

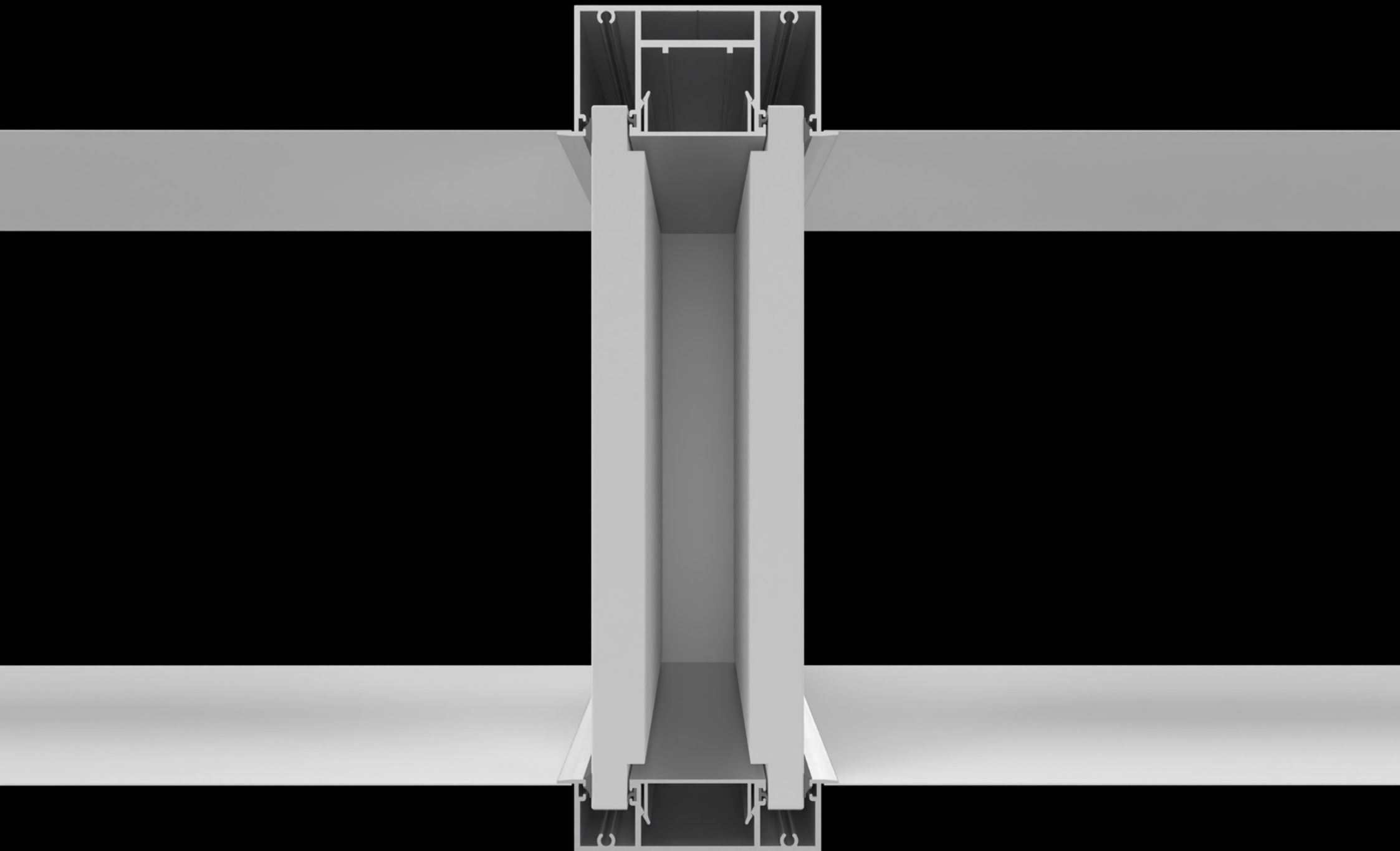



- 01.** Spessore 97 mm
- 02.** Profili incassati a pavimento, a soffitto, angoli e partenze in estruso di alluminio 6060 UNI 9006/1
- 03.** Doppi pannelli ciechi di nobilitato melaminico, laccati o impiallacciati - spessore 18 mm
- 04.** Profili d'angolo fissi e variabili - connessioni 2/3 vie
- 05.** Giunzioni verticali tra elementi vetrati in alluminio
- 06.** Modulo tecnico
- 07.** 5 versioni di porte battenti - cieche, in vetro temperato e intelaiate
- 08.** 1 versione di porta scorrevoli interna - intelaiata



Partenze

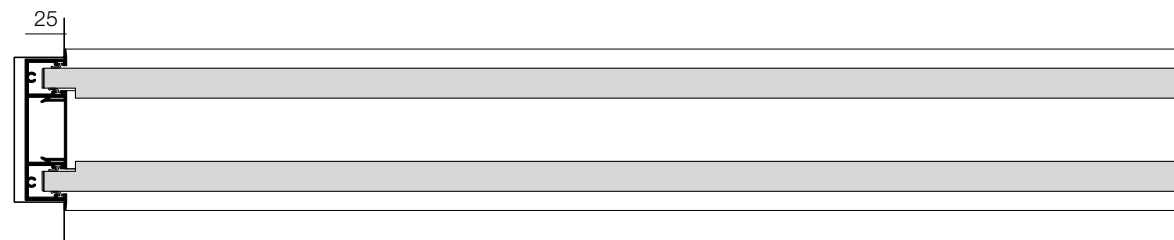
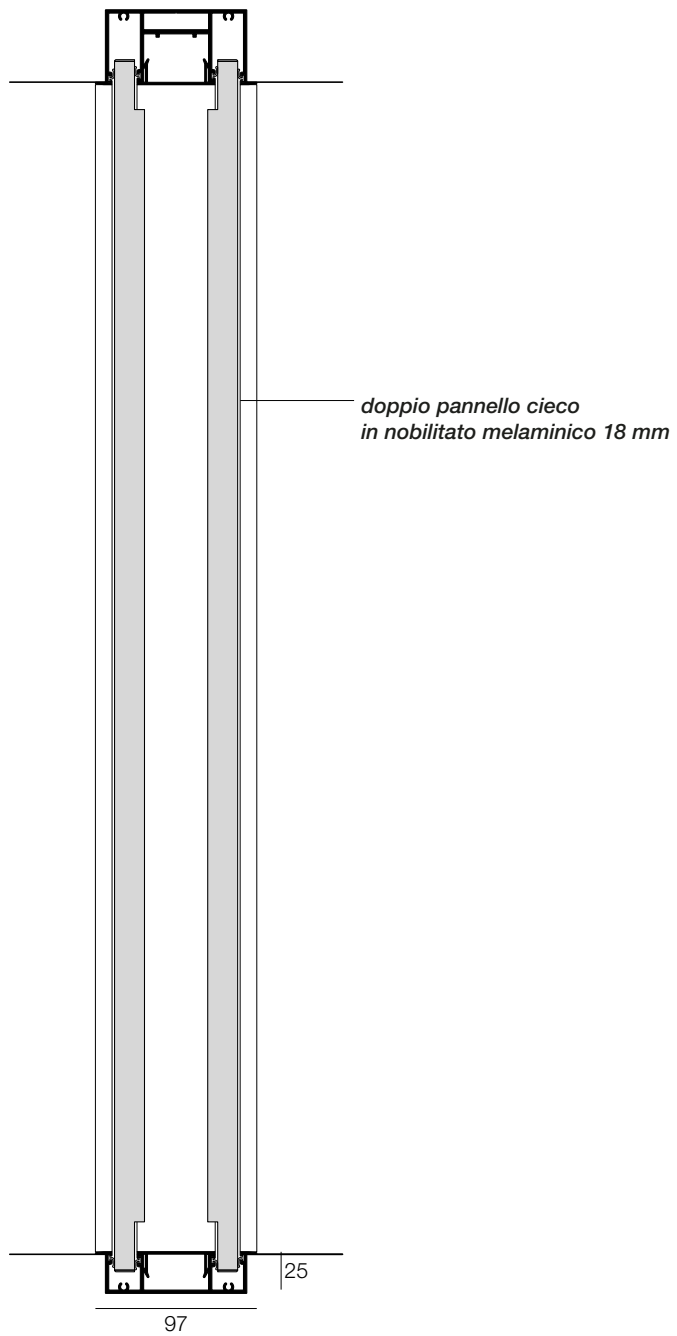

Partenza incassata a parete

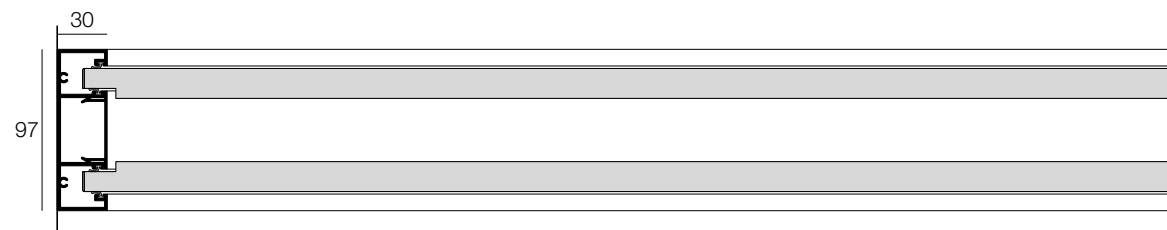

Partenza fissa da parete

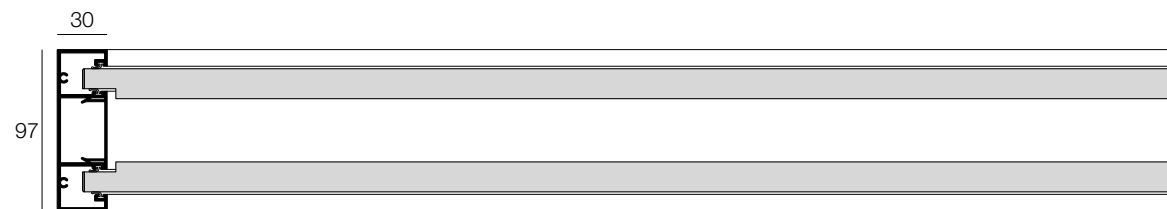

Profilo terminale

Partenze

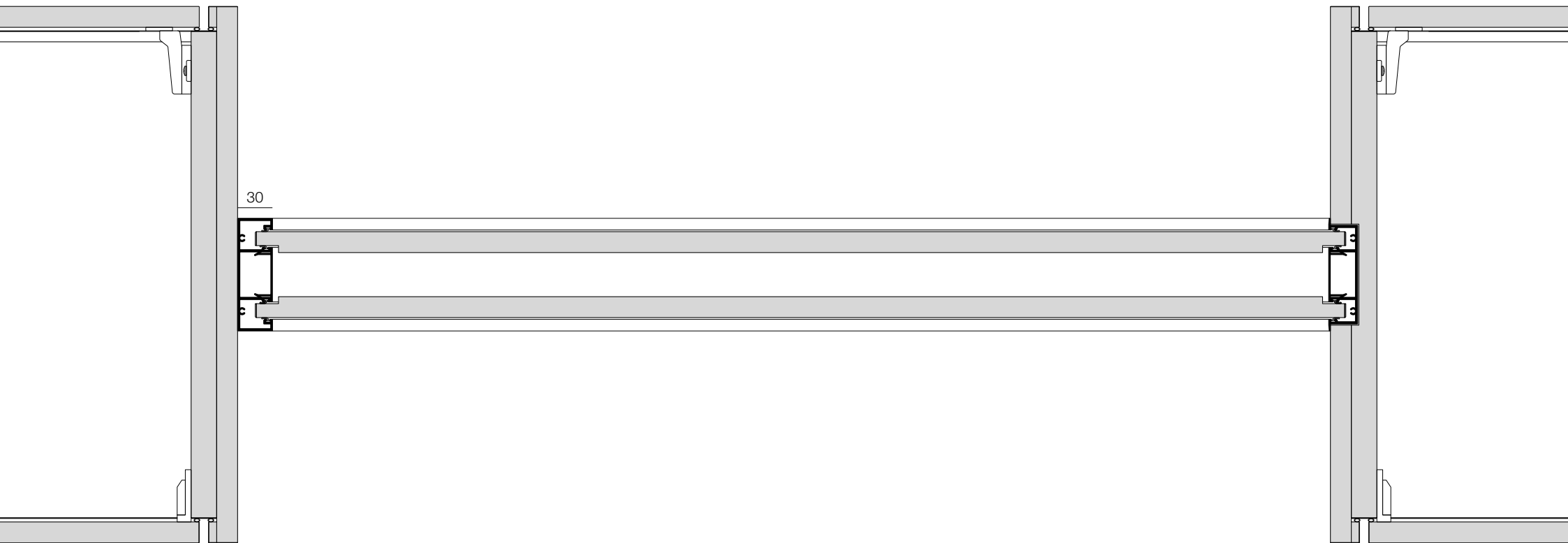

Partenza da contenitore

Partenza da contenitore incassata

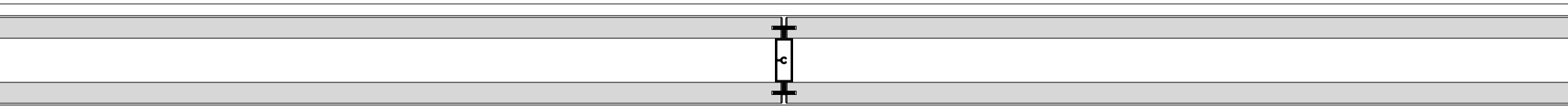

**Connessione in alluminio
metrica f solid - metrica f solid**

Angoli



**Angolo a 90°
legno-legno**

Modulo tecnico della porta a battente



Modulo tecnico

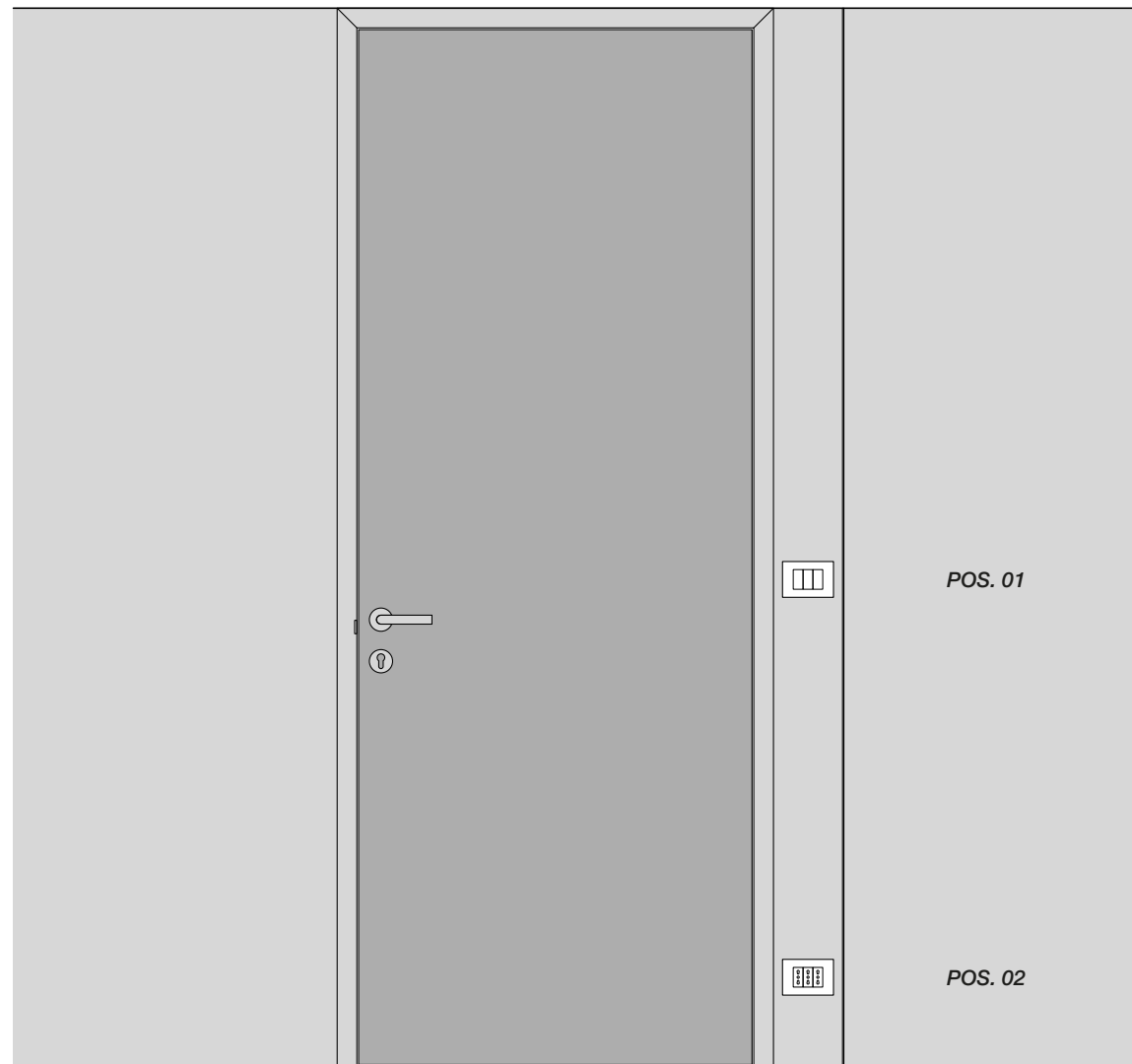
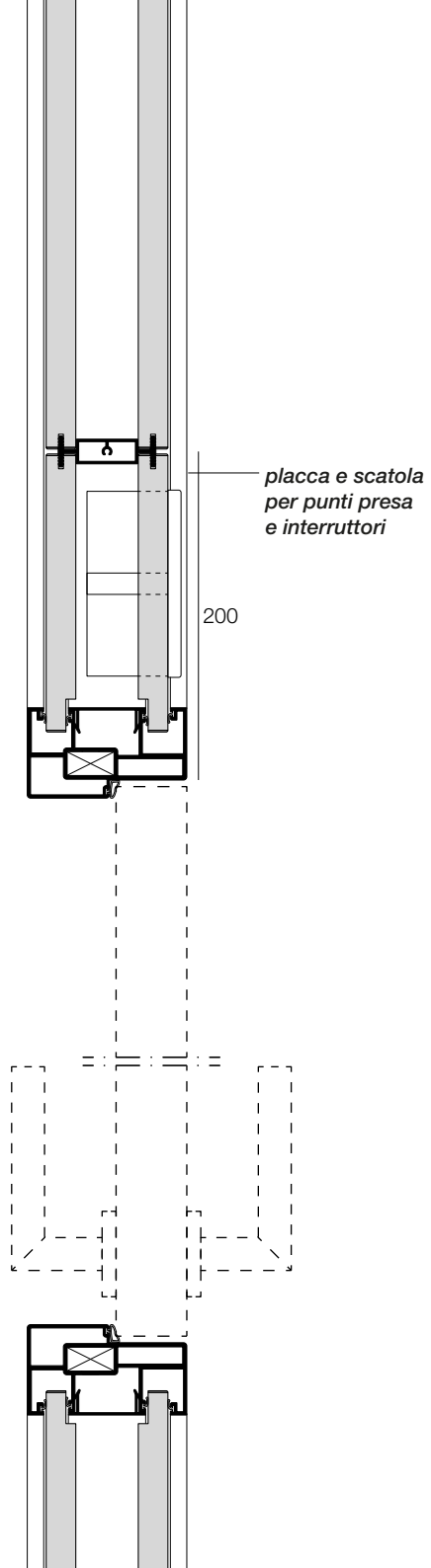

**posizioni possibili di interruttori e prese su modulo tecnico*

METRICA[®]
SENZA STRUTTURA

Porte e maniglie

TELAI PORTE BATTENTI

Metrica D



Telaio porta **Metrica D** su **Metrica D1**

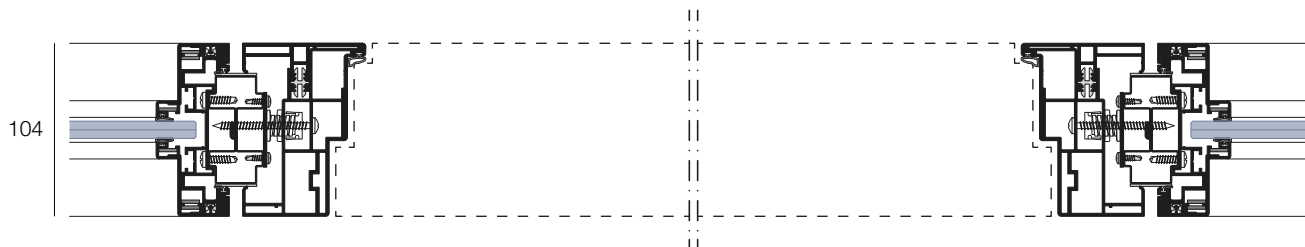

Telaio porta **Metrica D** su **Metrica D2**

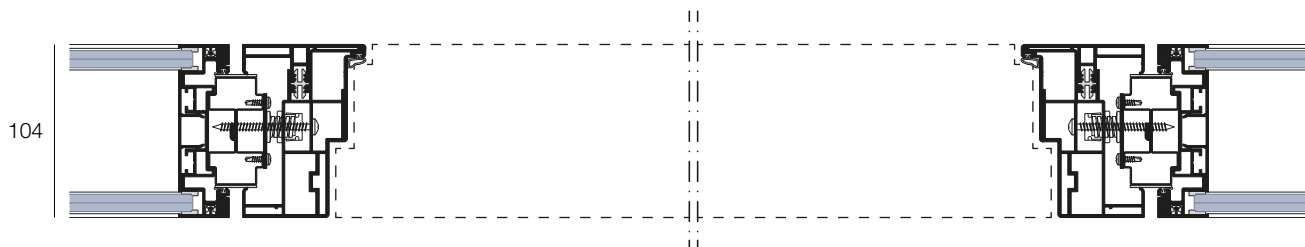

Telaio porta **Metrica D** su **Metrica Solid**

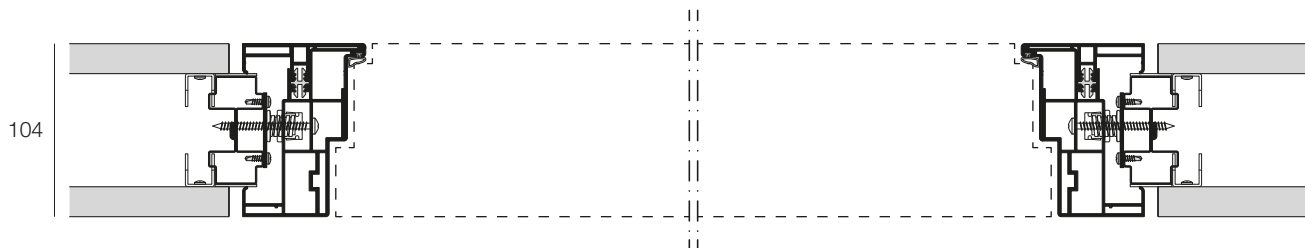

ANTA INTELAIATA CIECA_CON DOPPIA BATTUTA sp. 104 mm

Porta complanare

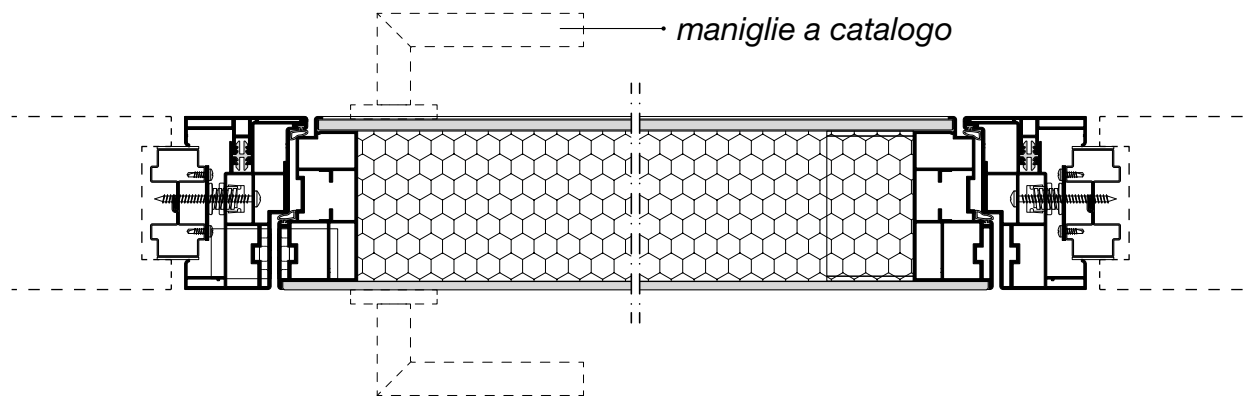
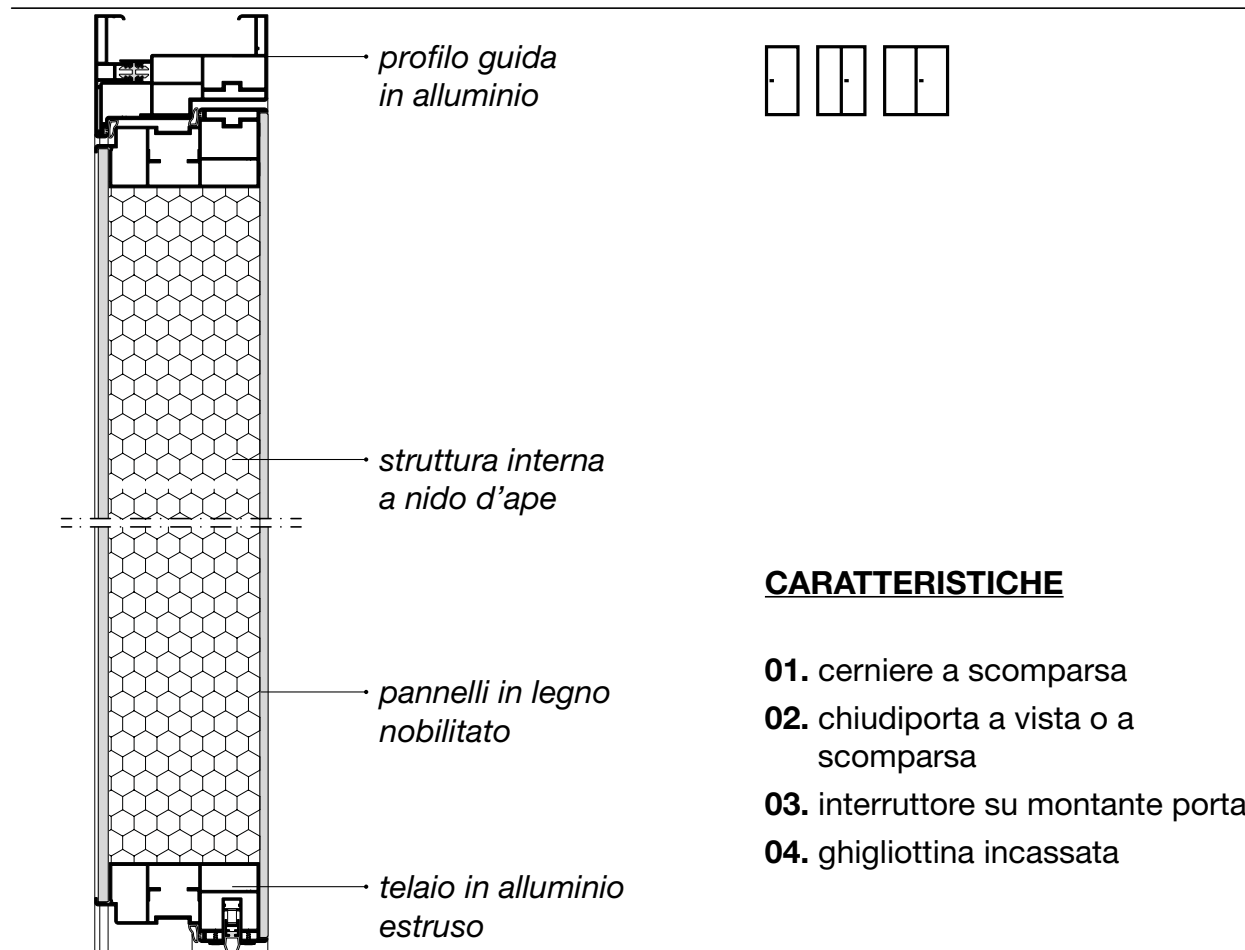

ANTA INTELAIATA CIECA_ CON DOPPIA BATTUTA sp. 104 mm

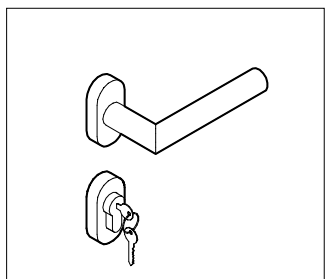

ML5

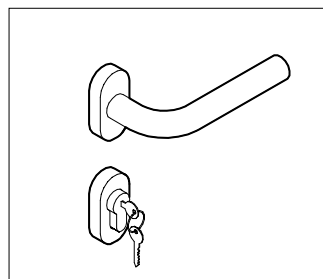

ML6

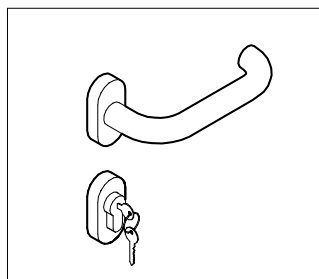

ML7

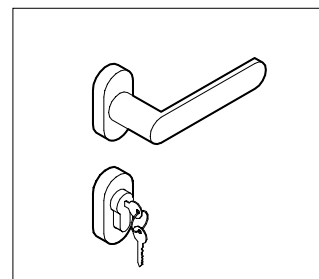

ML8

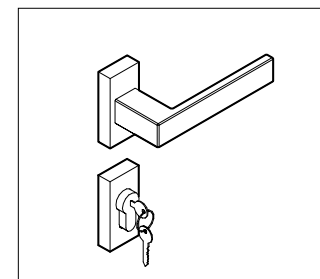

ML9

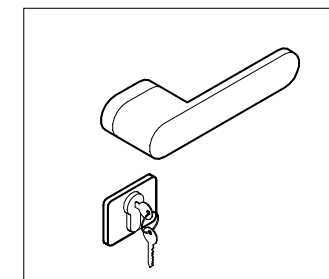

ML10

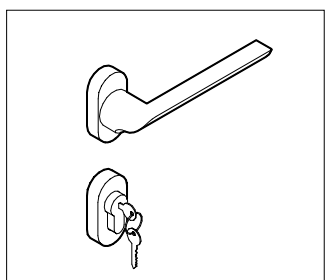

ML11

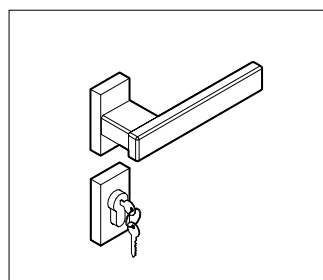

MLQ

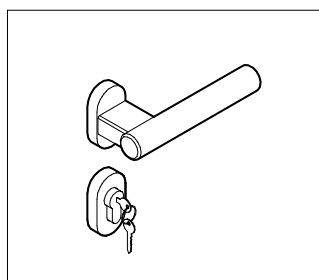

MLT

ANTA INTELAIATA VETRO DOPPIO SERIGRAFATO_CON DOPPIA BATTUTA sp. 104 mm



Porta complanare

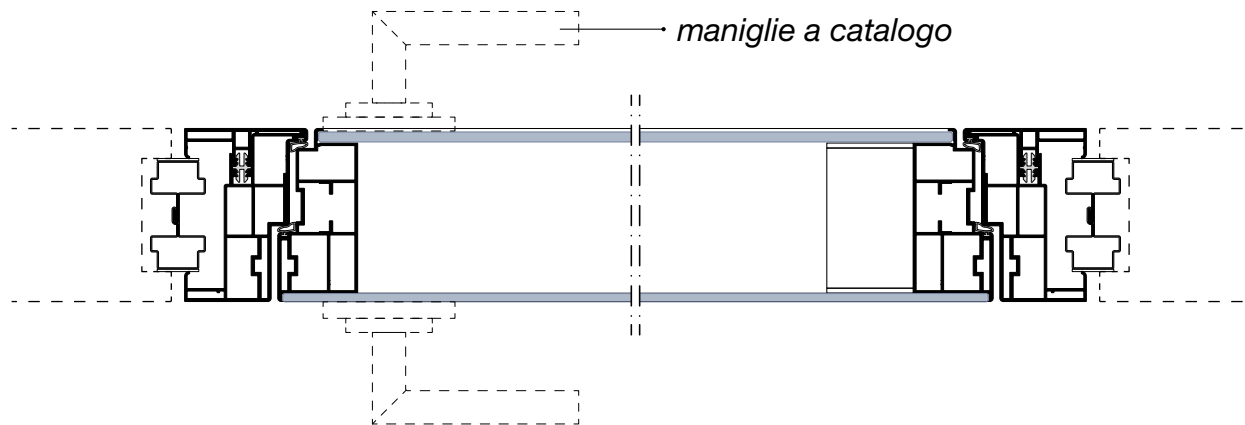
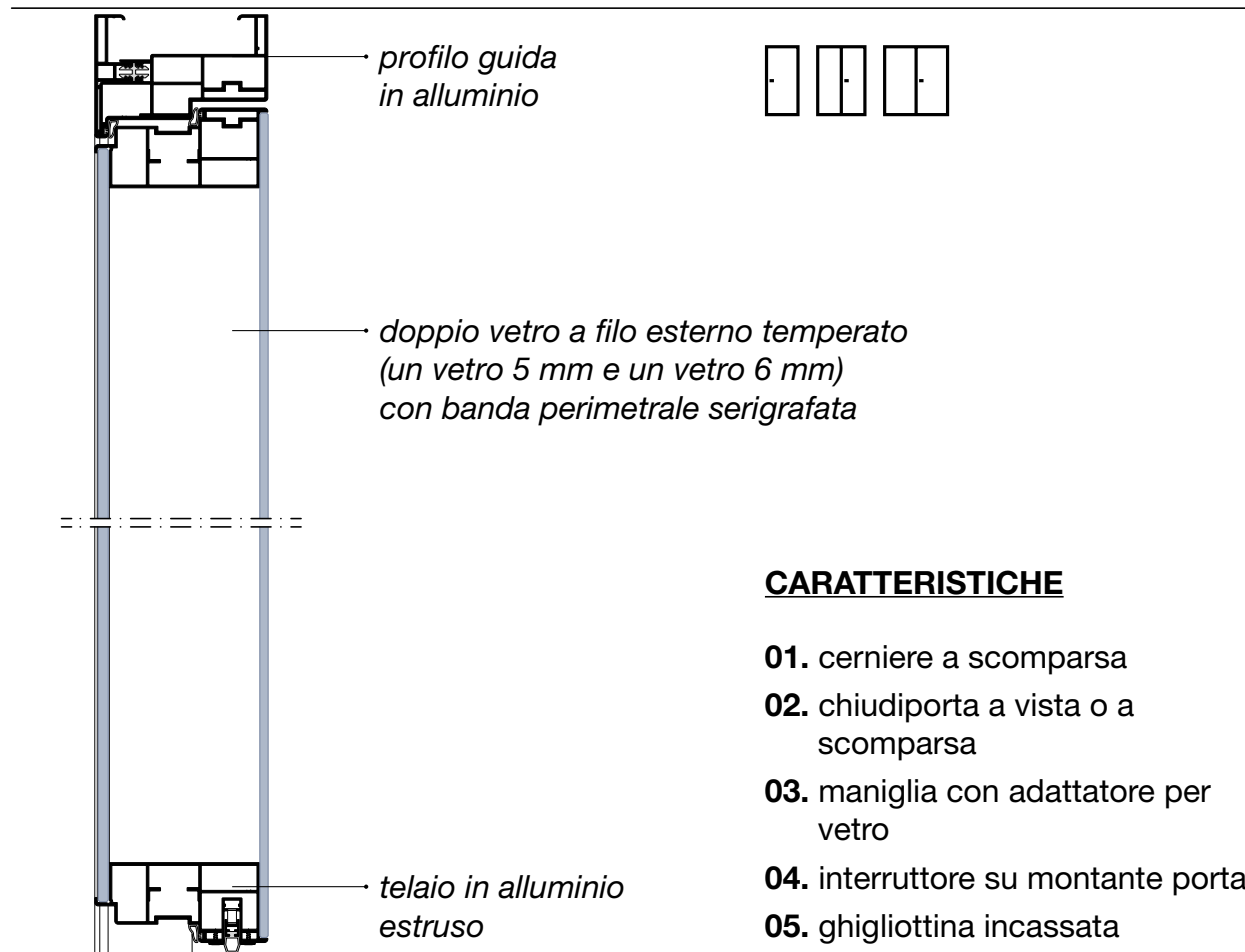

ANTA INTELAIATA VETRO DOPPIO SERIGRAFATO_CON DOPPIA BATTUTA sp. 104 mm

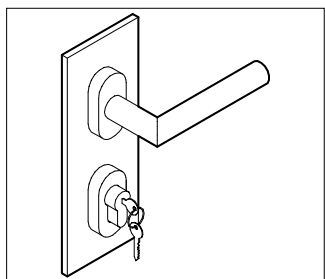

ML5

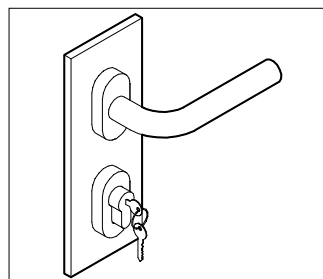

ML6

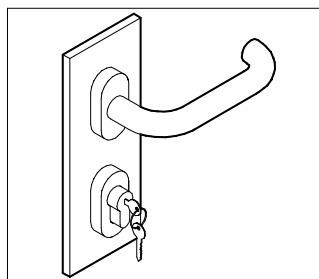

ML7

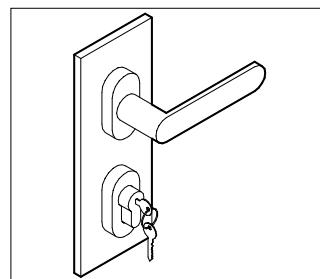

ML8

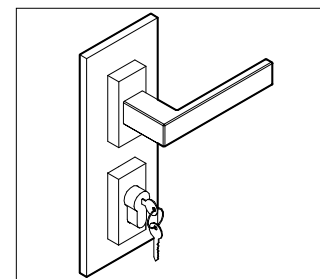

ML9

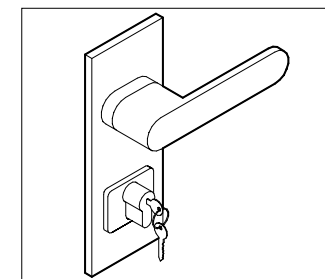

ML10

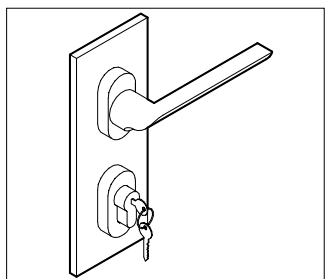

ML11

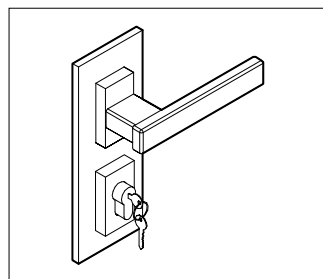

MLQ

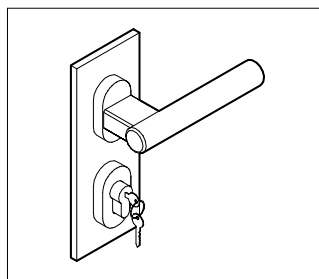

MLT

TELAI PORTE BATTENTI

Metrica strutturale



Telaio porta **Metrica Strutturale** su **Metrica D1**

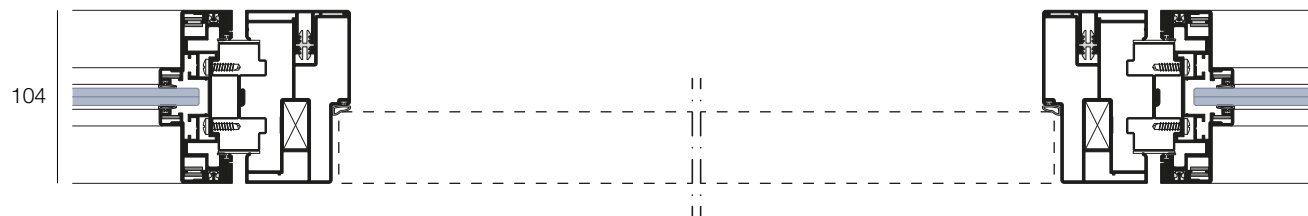

Telaio porta **Metrica Strutturale** su **Metrica D2**

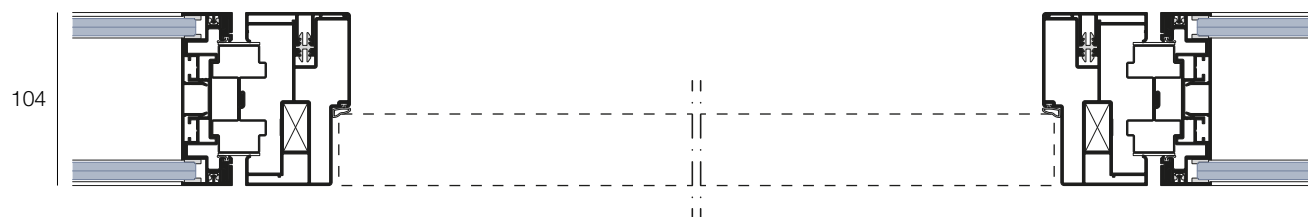

Telaio porta **Metrica Strutturale** su **Metrica Solid**

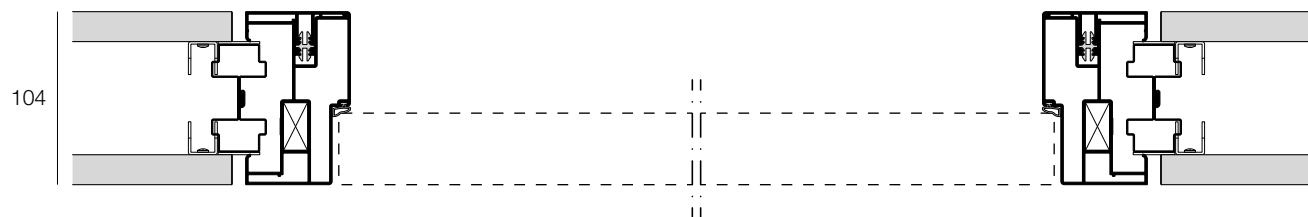

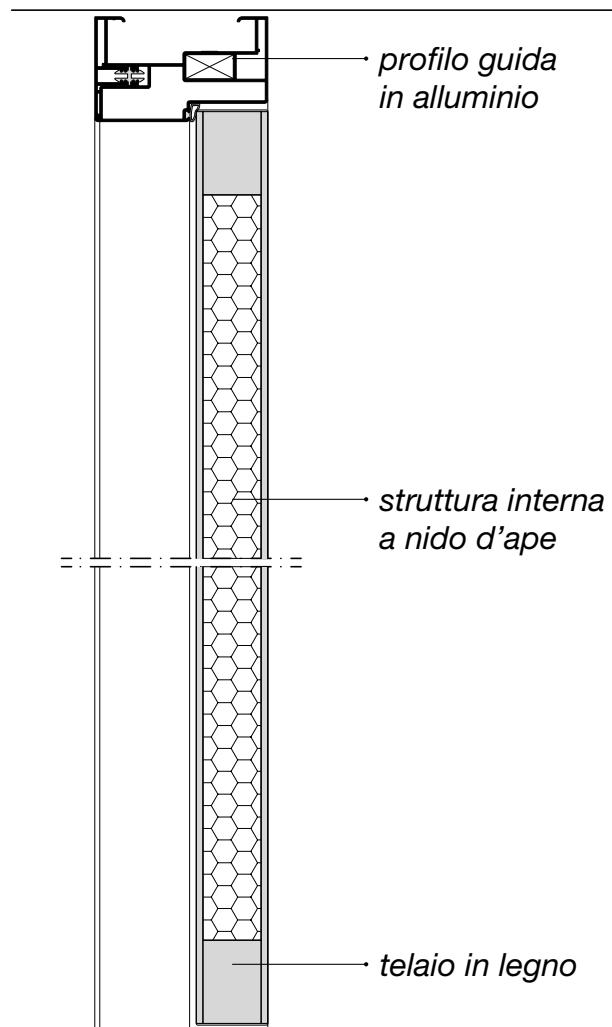

CARATTERISTICHE

- 01.** cerniere a vista o a scomparsa
- 02.** chiudiporta a vista o a scomparsa
- 03.** interruttore su montante porta
- 04.** ghigliottina incassata

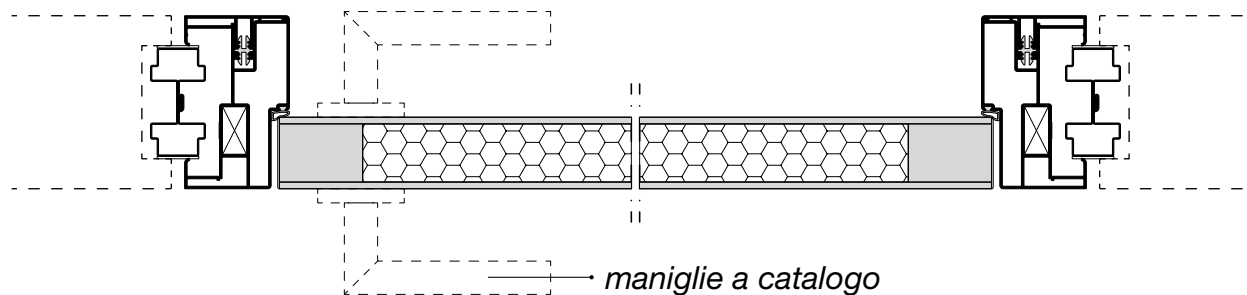

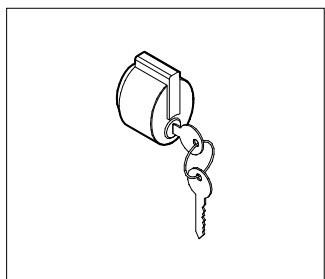

ML1

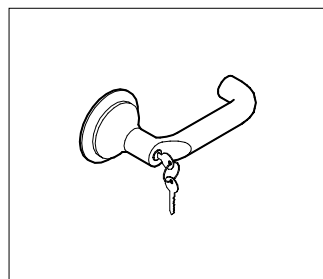

ML4

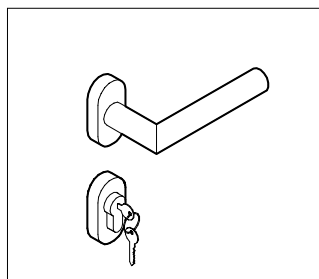

ML5

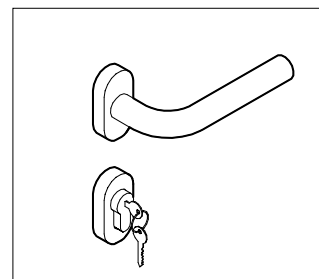

ML6

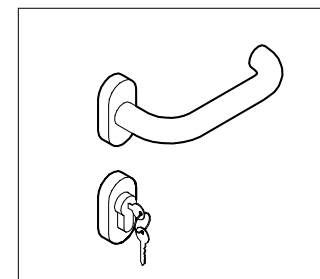

ML7

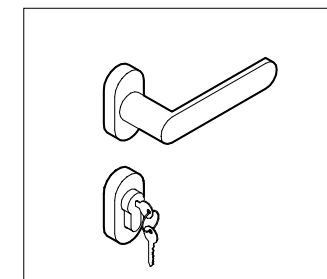

ML8

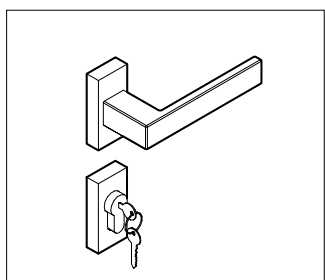

ML9

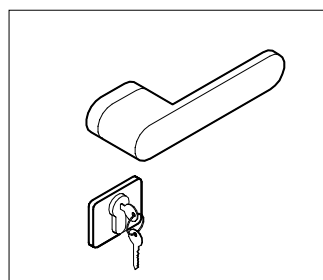

ML10

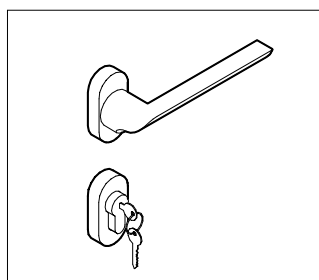

ML11

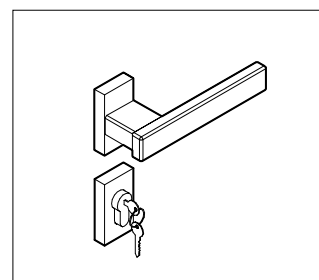

MLQ

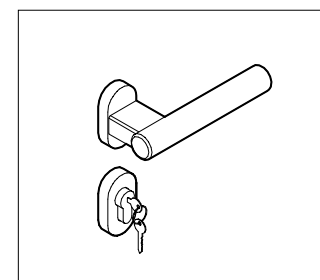

MLT

ANTA VETRO TEMPERATO_CERNIERE A VISTA sp. 10 mm

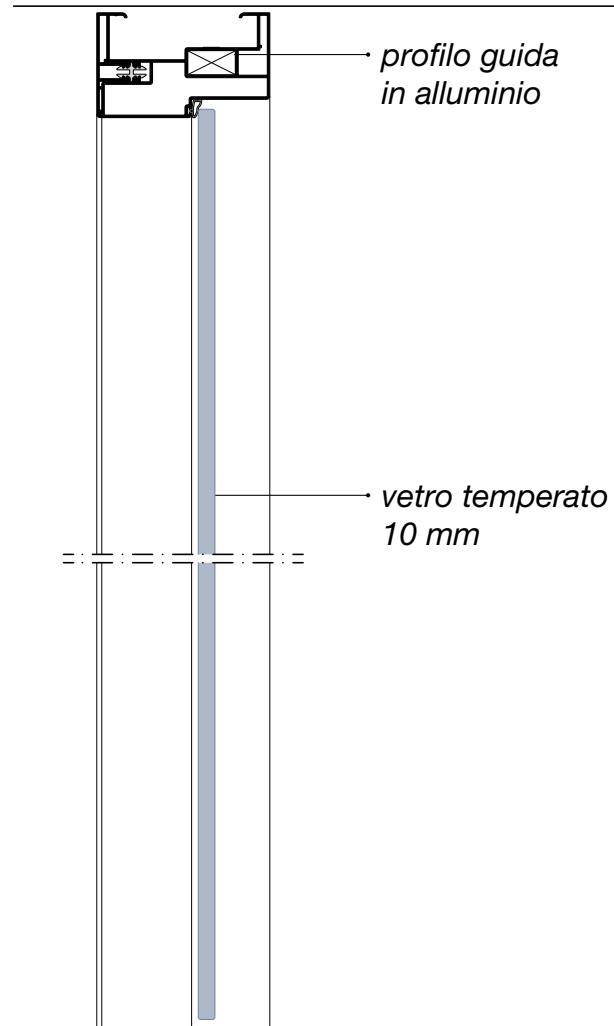
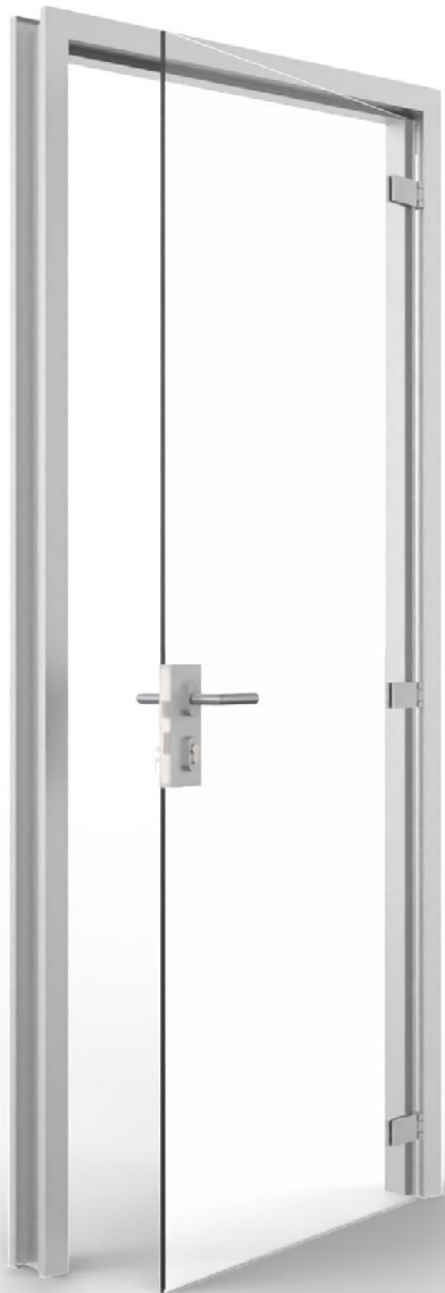

CARATTERISTICHE

- 01.** cerniere a vista - 110° o 180°
- 02.** chiudiporta a vista
- 03.** maniglia con adattatore per vetro
- 04.** interruttore su montante porta
- 05.** ghigliottina esterna

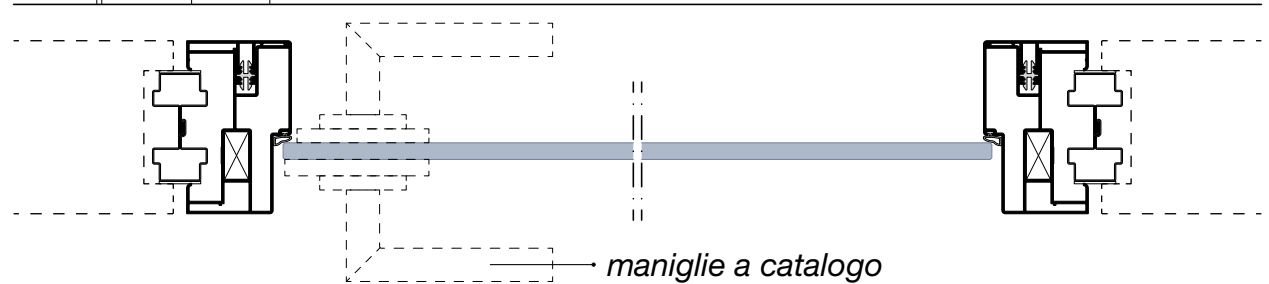

ANTA VETRO TEMPERATO_CERNIERE A VISTA sp. 10 mm

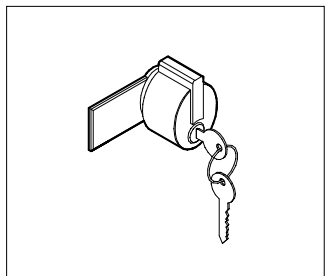

MC1

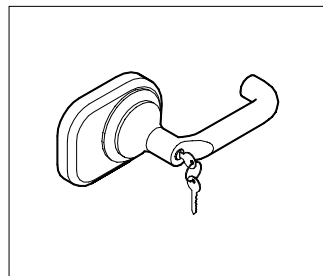

MC4

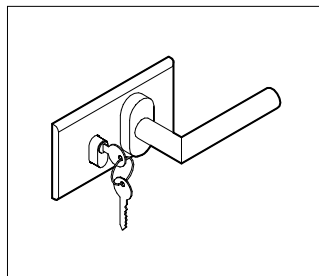

MC5

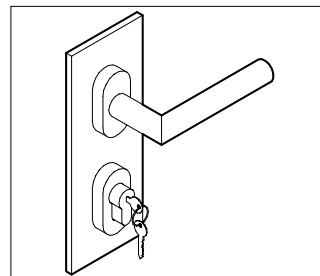

MC5V

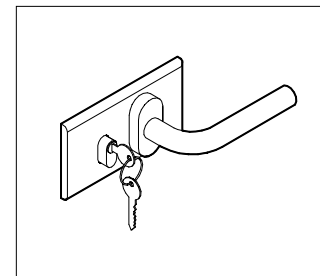

MC6

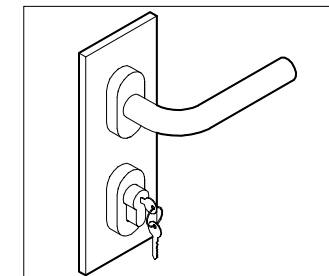

MC6V

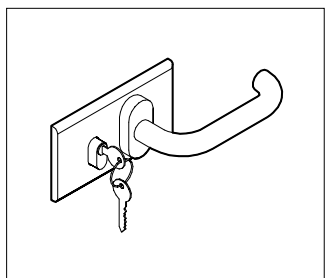

MC7

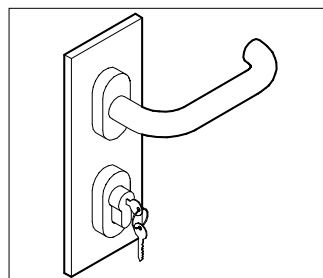

MC7V

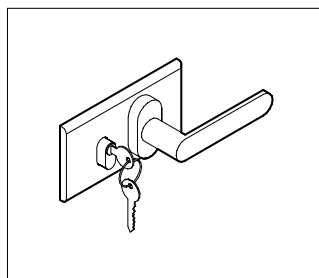

MC8

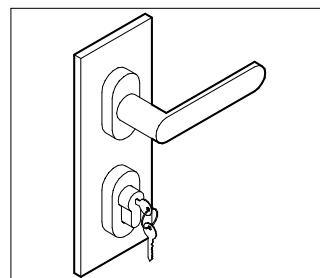

MC8V

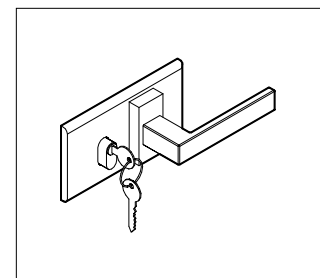

MC9

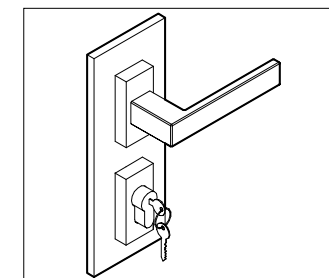

MC9V

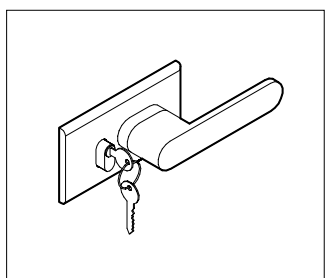

MC10

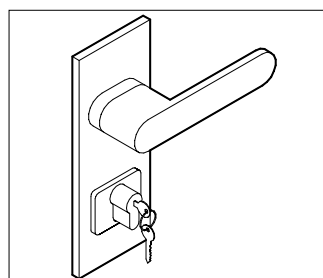

MC10V

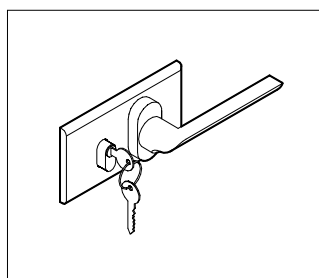

MC11

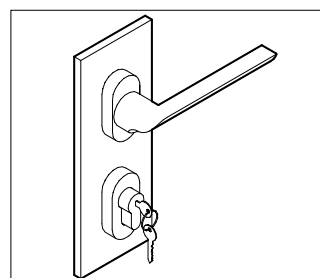

MC11V

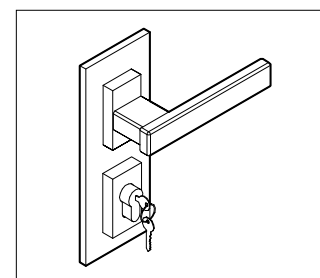

MCQ

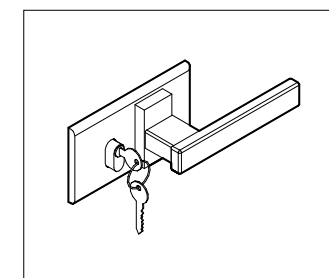

MCQO

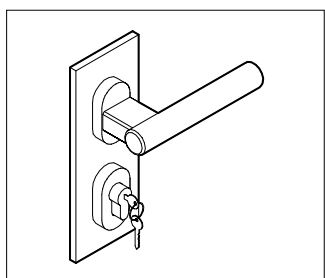

MCT

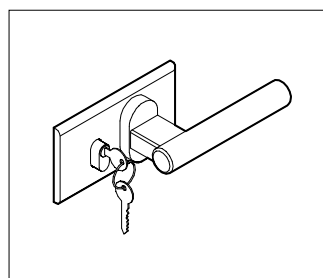

MCTO

ANTA VETRO TEMPERATO_CERNIERA CONTINUA sp. 10 mm

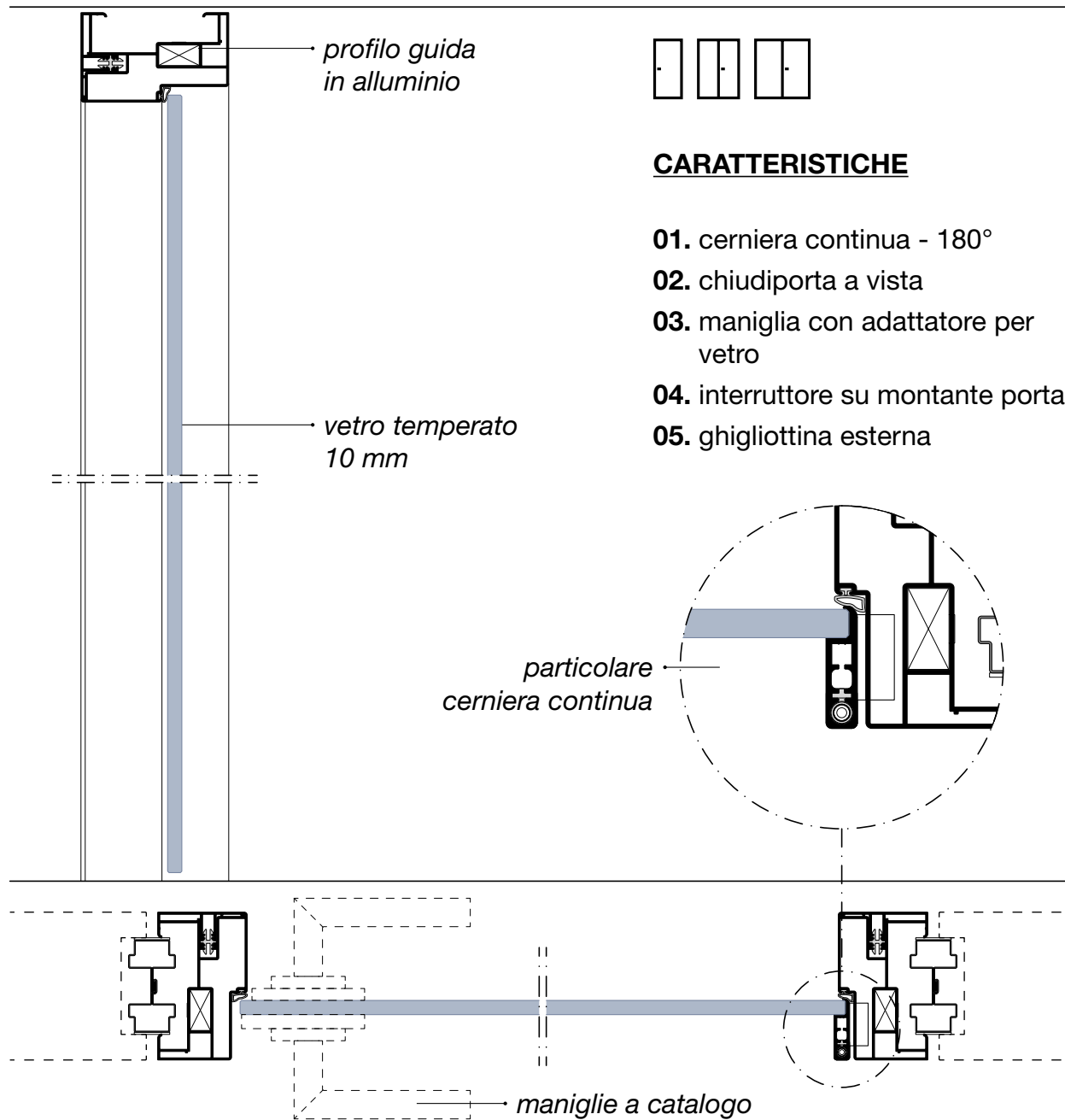
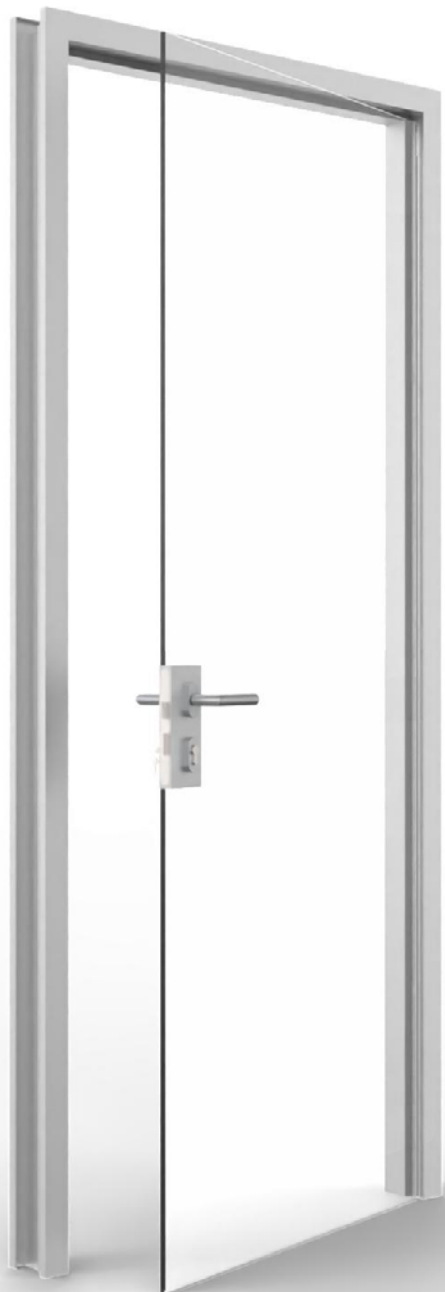

ANTA VETRO TEMPERATO_CERNIERA CONTINUA sp. 10 mm

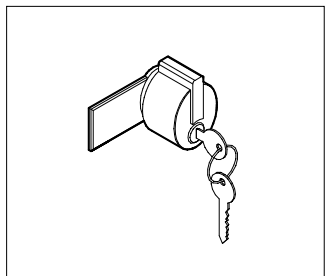

MC1

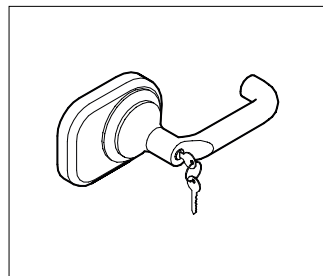

MC4

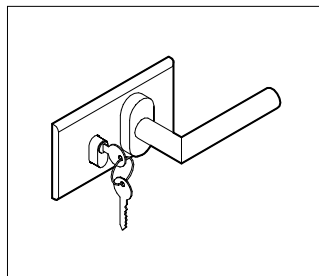

MC5

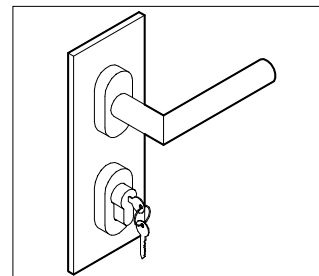

MC5V

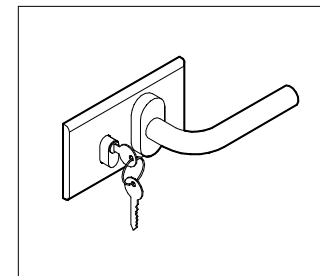

MC6

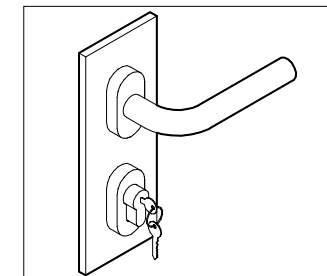

MC6V

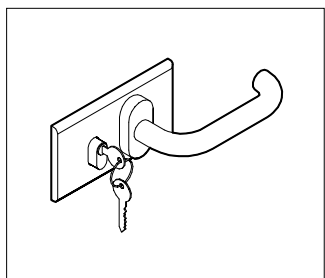

MC7

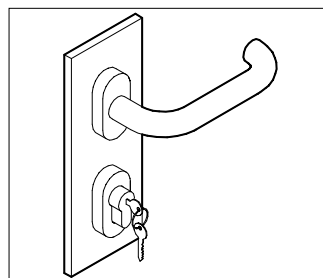

MC7V

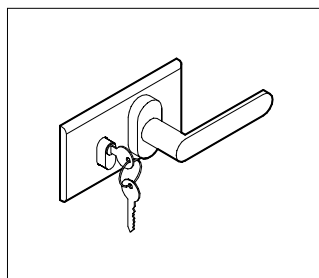

MC8

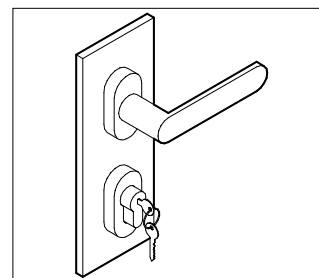

MC8V

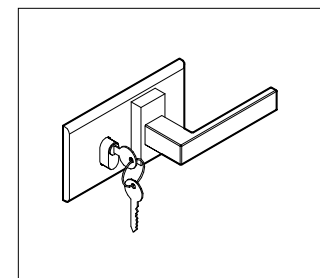

MC9

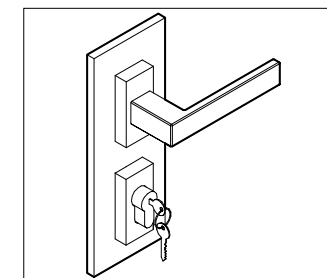

MC9V

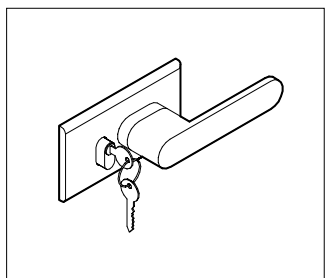

MC10

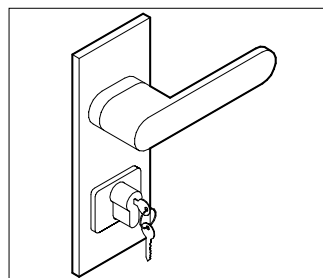

MC10V

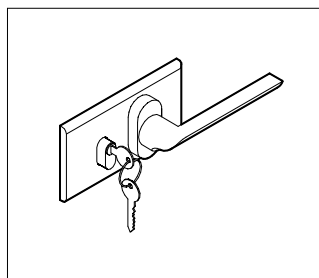

MC11

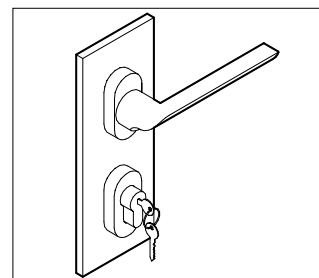

MC11V

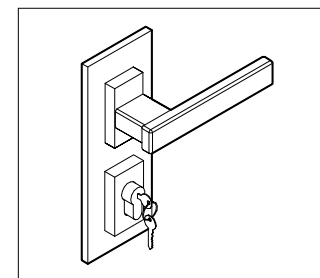

MCQ

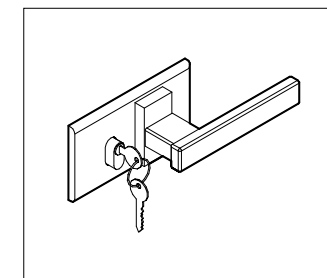

MCQO

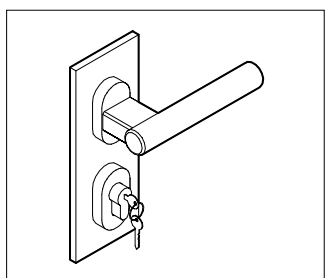

MCT

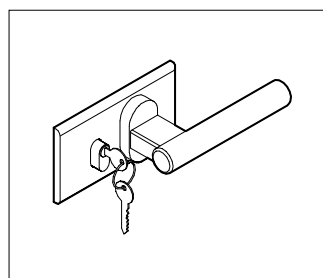

MCTO

ANTA INTELAIATA GRANDE CON PANNELLO sp. 43 mm

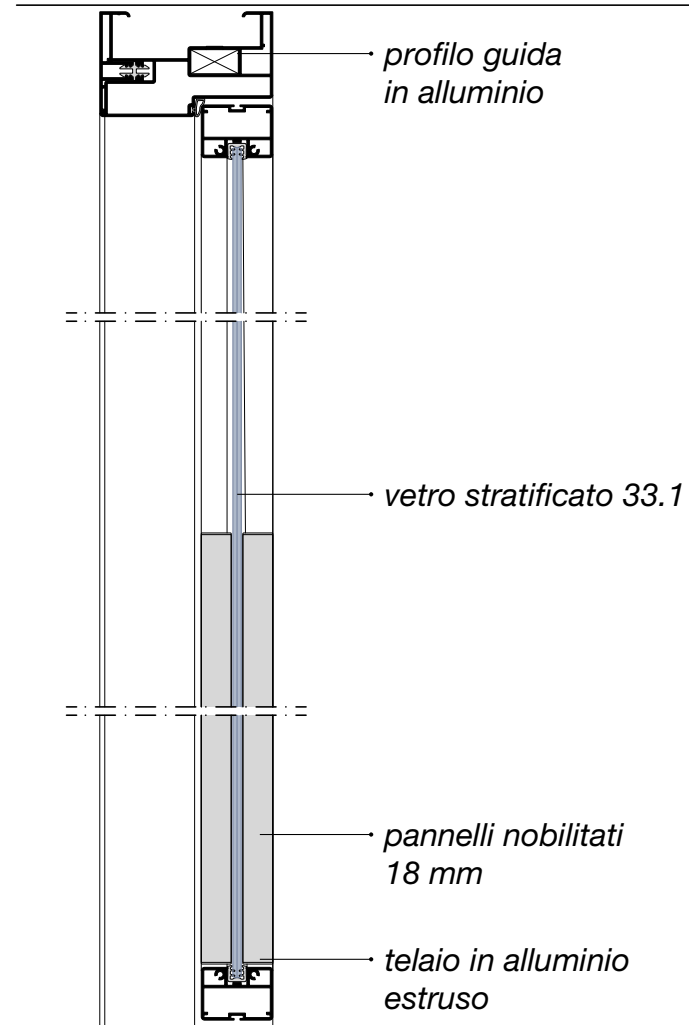

CARATTERISTICHE

- 01.** cerniere a vista o a scomparsa
- 02.** chiudiporta a vista
- 03.** interruttore su montante porta
- 04.** ghigliottina incassata

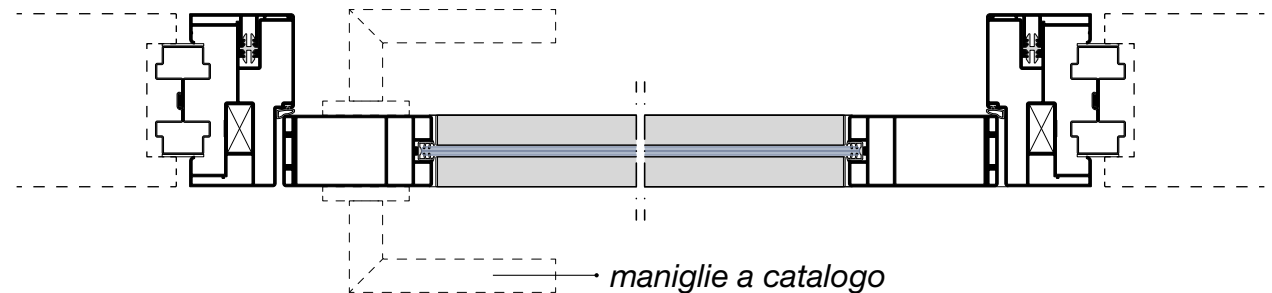

ANTA INTELAIATA GRANDE CON PANNELLO sp. 43 mm

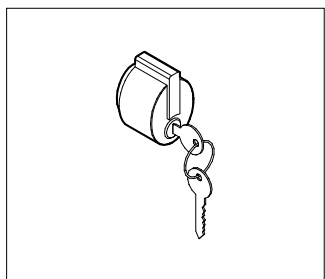

ML1

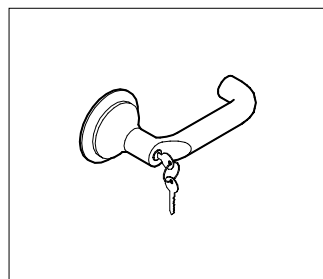

ML4

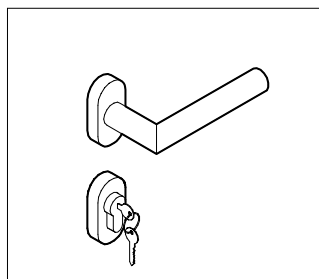

ML5

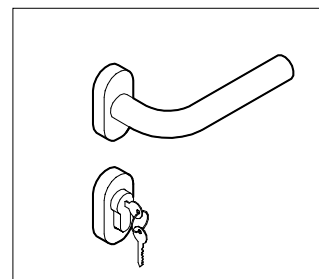

ML6

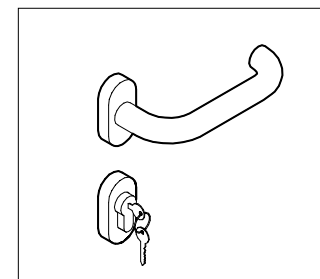

ML7

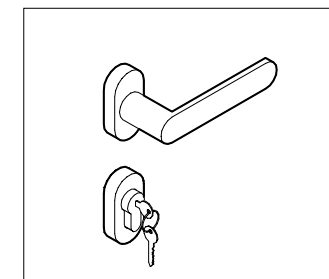

ML8

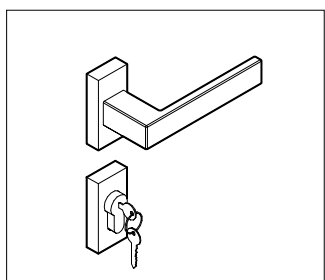

ML9

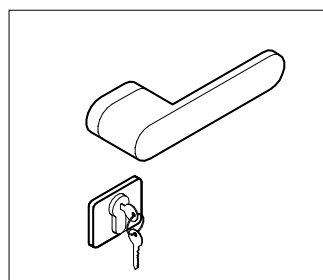

ML10

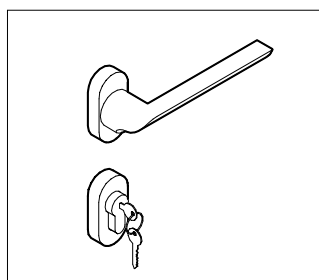

ML11

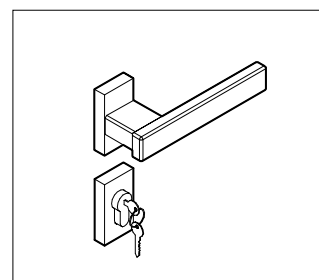

MLQ

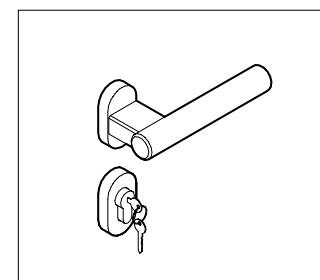

MLT

ANTA INTELAIATA GRANDE sp. 43 mm

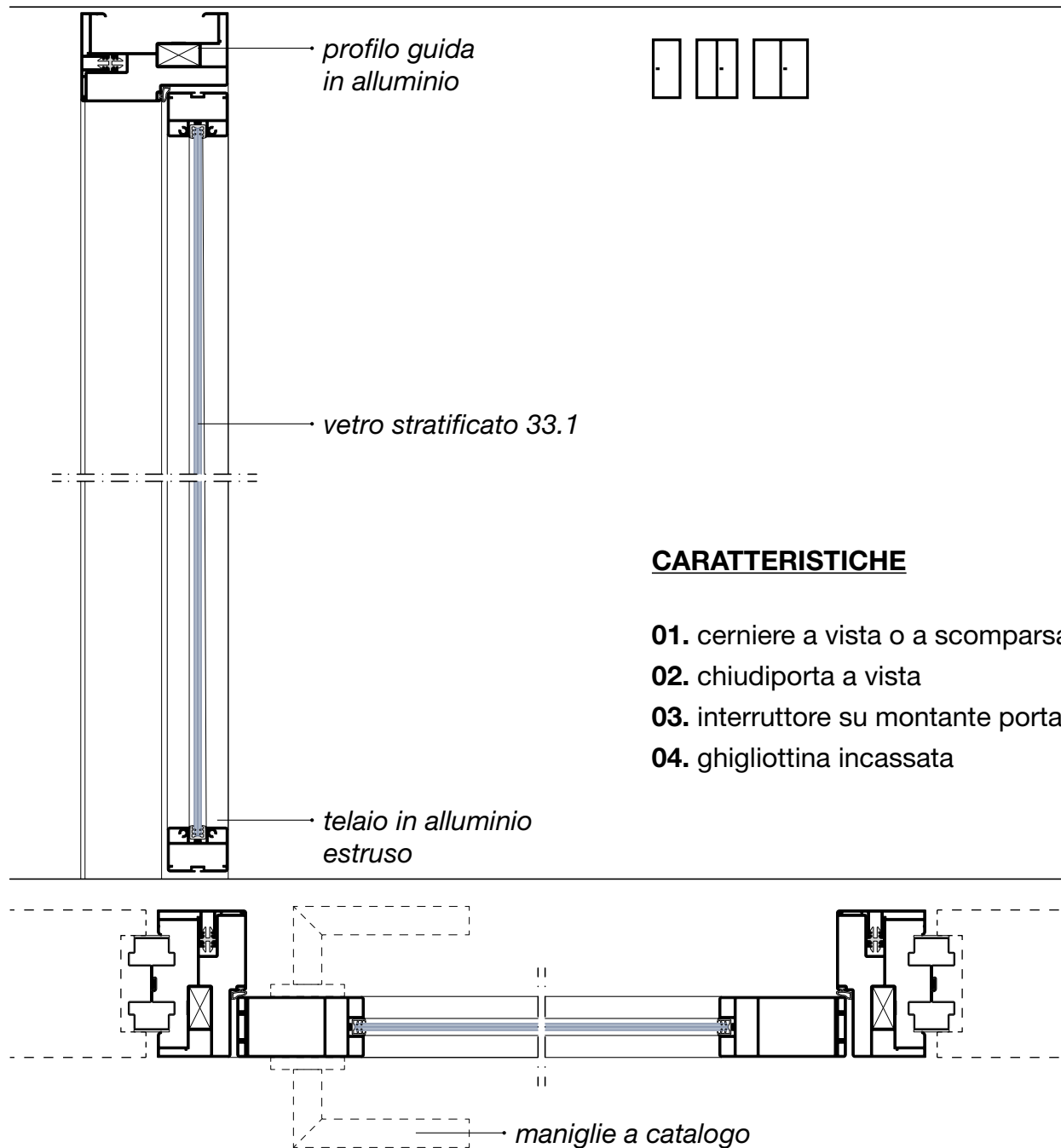

ANTA INTELAIATA GRANDE sp. 43 mm

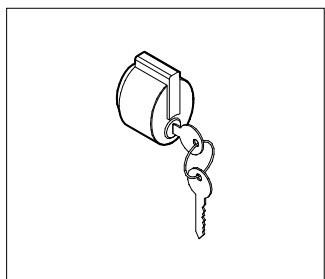

ML1

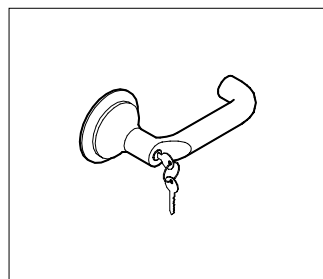

ML4

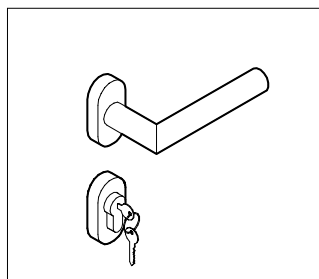

ML5

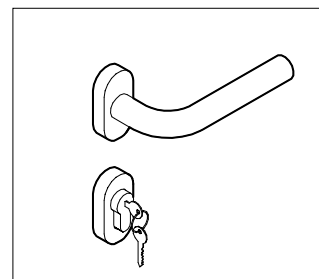

ML6

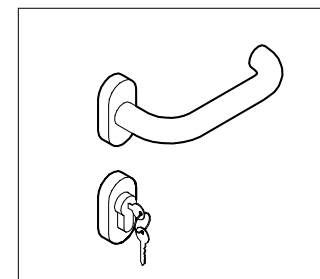

ML7

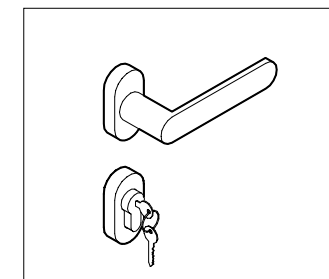

ML8

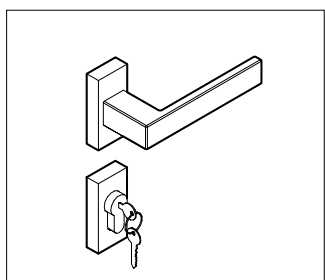

ML9

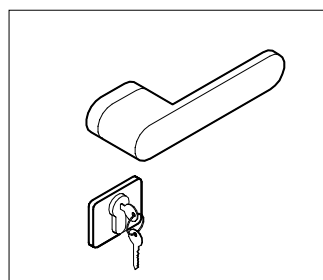

ML10

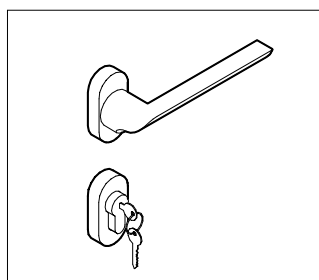

ML11

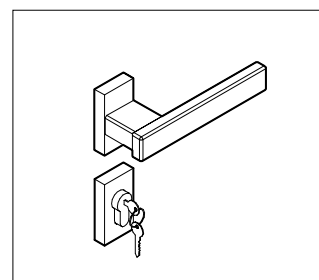

MLQ

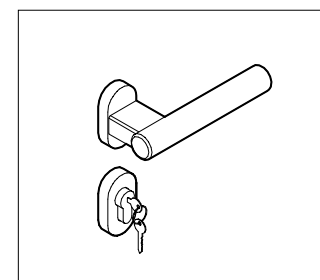

MLT

ANTA INTELAIATA MEDIA sp. 43 mm

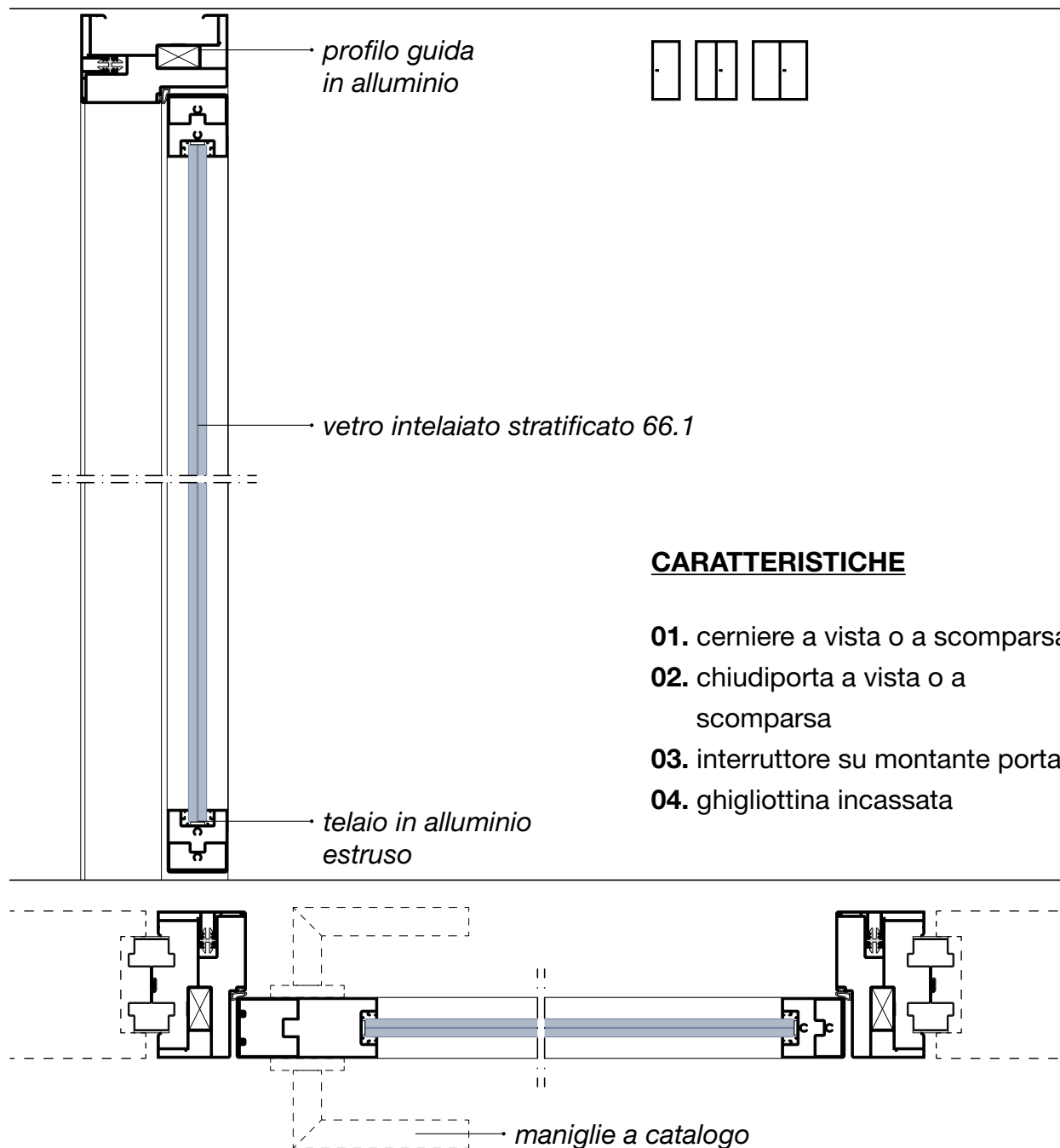

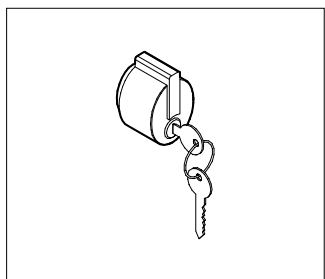

ML1

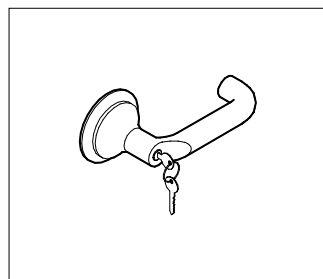

ML4

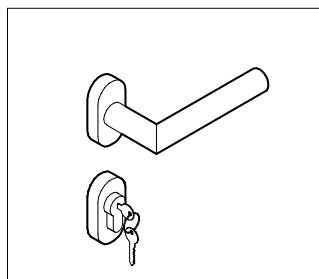

ML5

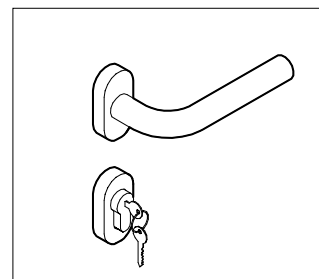

ML6

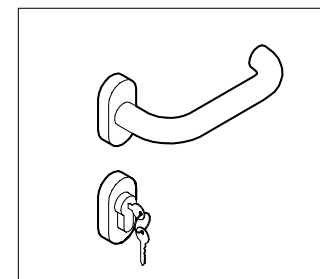

ML7

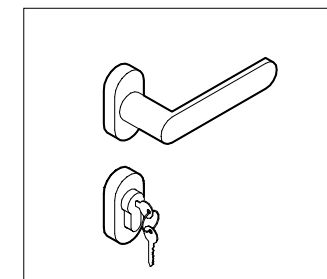

ML8

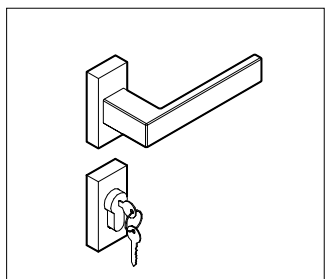

ML9

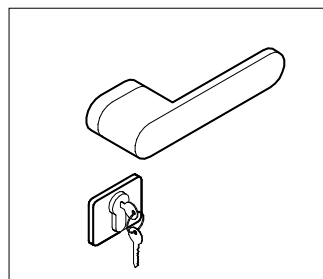

ML10

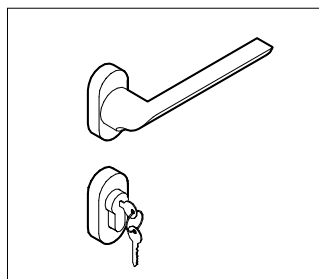

ML11

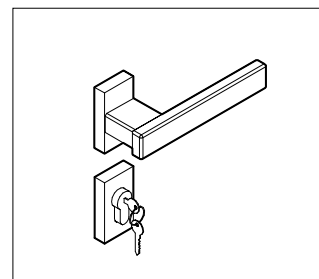

MLQ

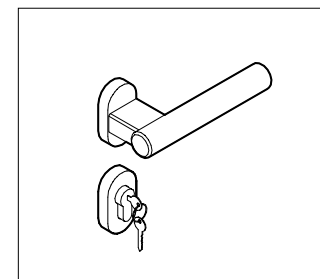

MLT

ANTA INTELAIATA SOTTILE sp. 43 mm

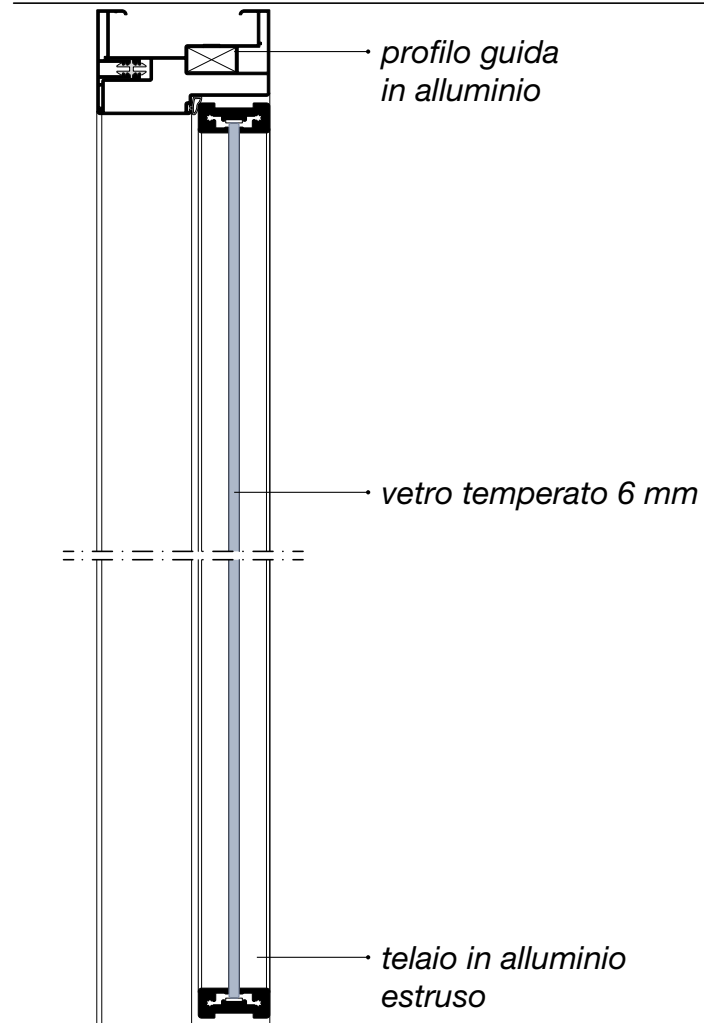

CARATTERISTICHE

- 01. cerniere a vista
- 02. chiudiporta a vista
- 03. maniglia con adattatore per vetro
- 04. interruttore su montante porta

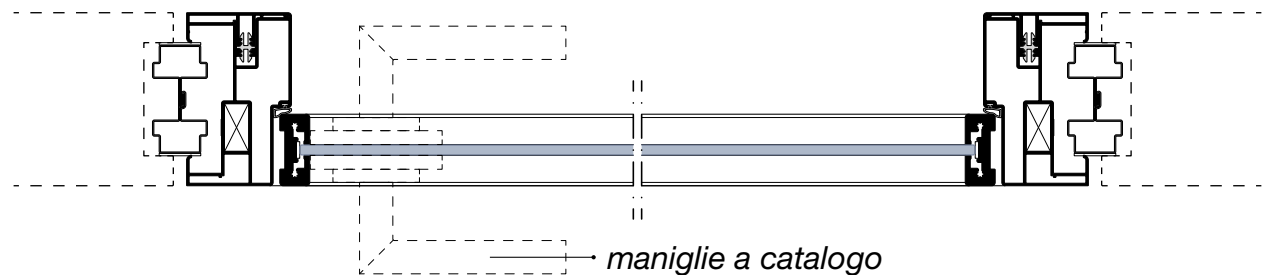

ANTA INTELAIATA SOTTILE sp. 43 mm

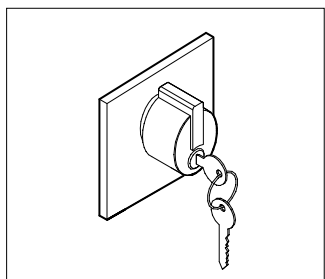

ML1

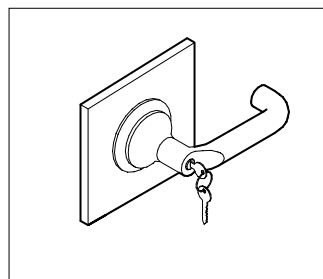

ML4

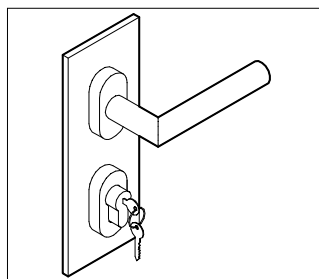

ML5

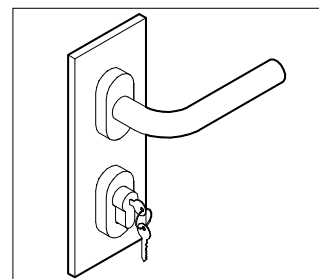

ML6

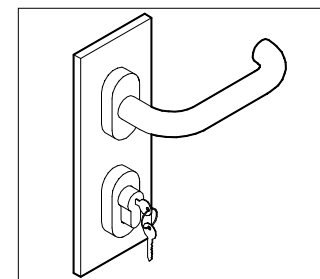

ML7

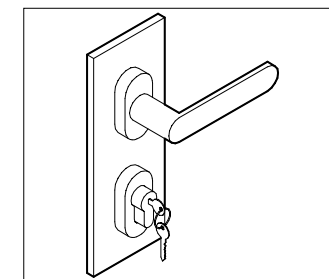

ML8

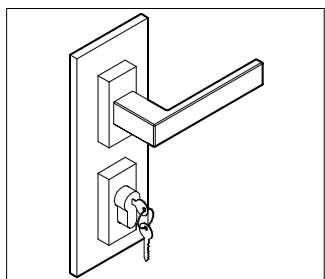

ML9

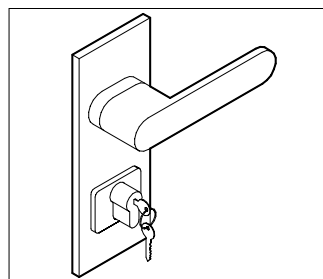

ML10

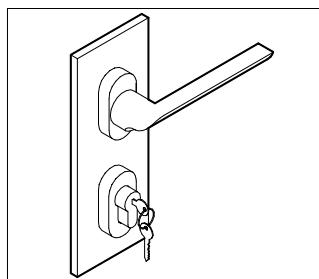

ML11

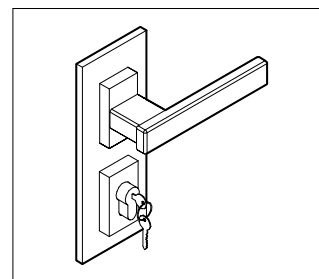

MLQ

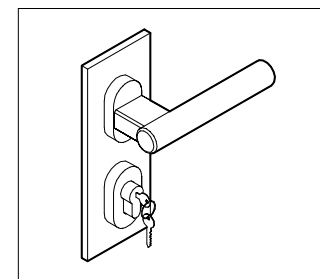

MLT

ANTA INTELAIATA VETRO DOPPIO sp. 51 mm

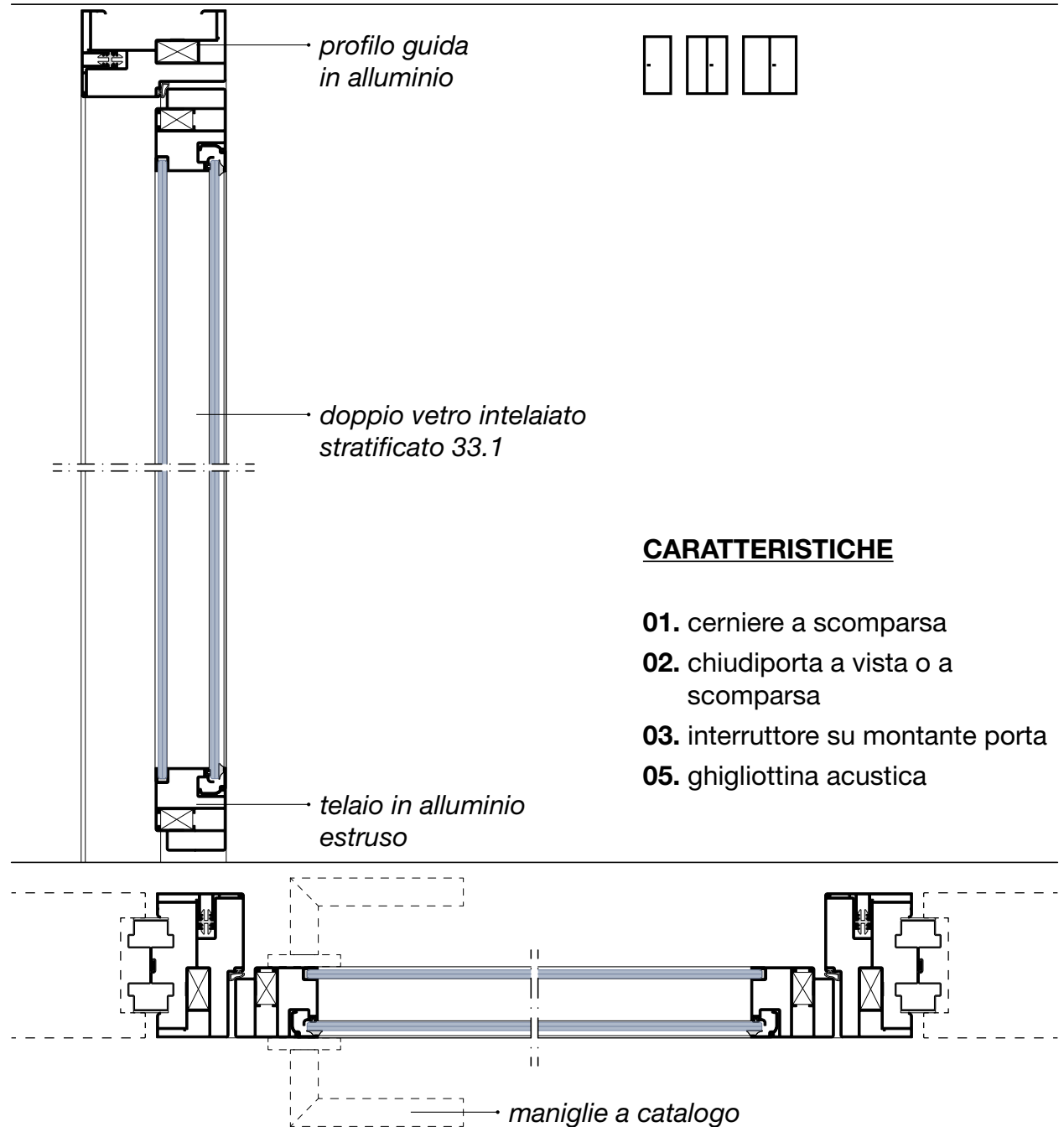

ANTA INTELAIATA VETRO DOPPIO sp. 51 mm

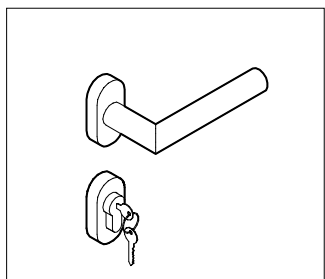

ML5

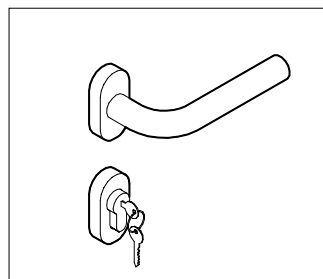

ML6

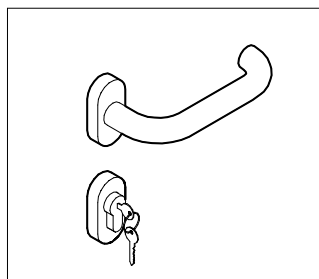

ML7

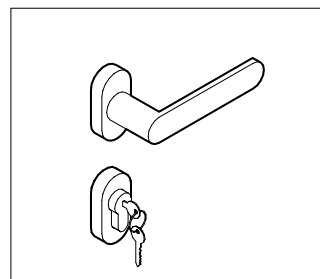

ML8

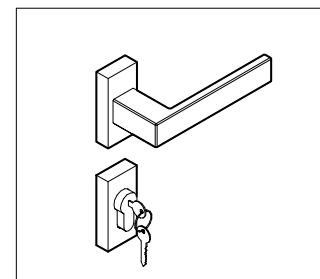

ML9

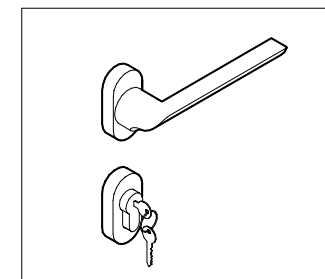

ML11

ANTA INTELAIATA CIECA sp. 104 mm

Porta complanare

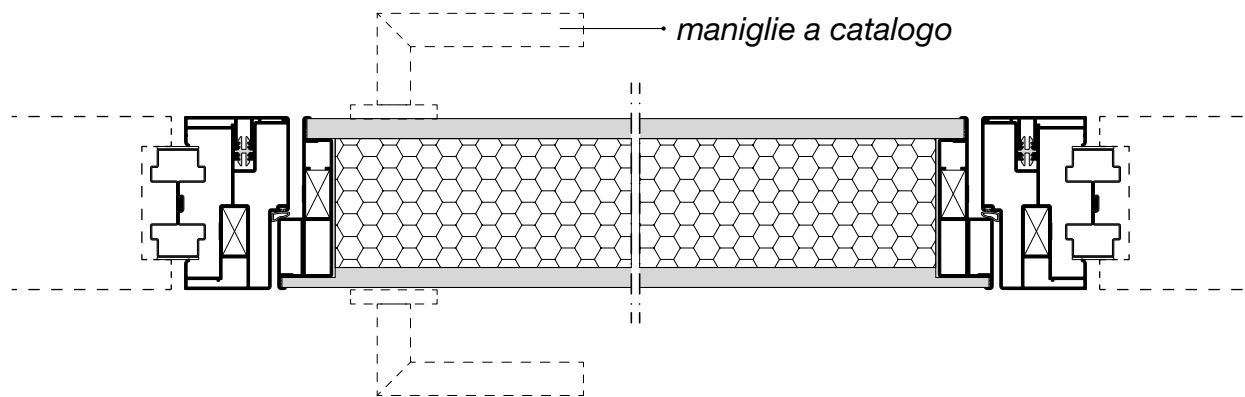
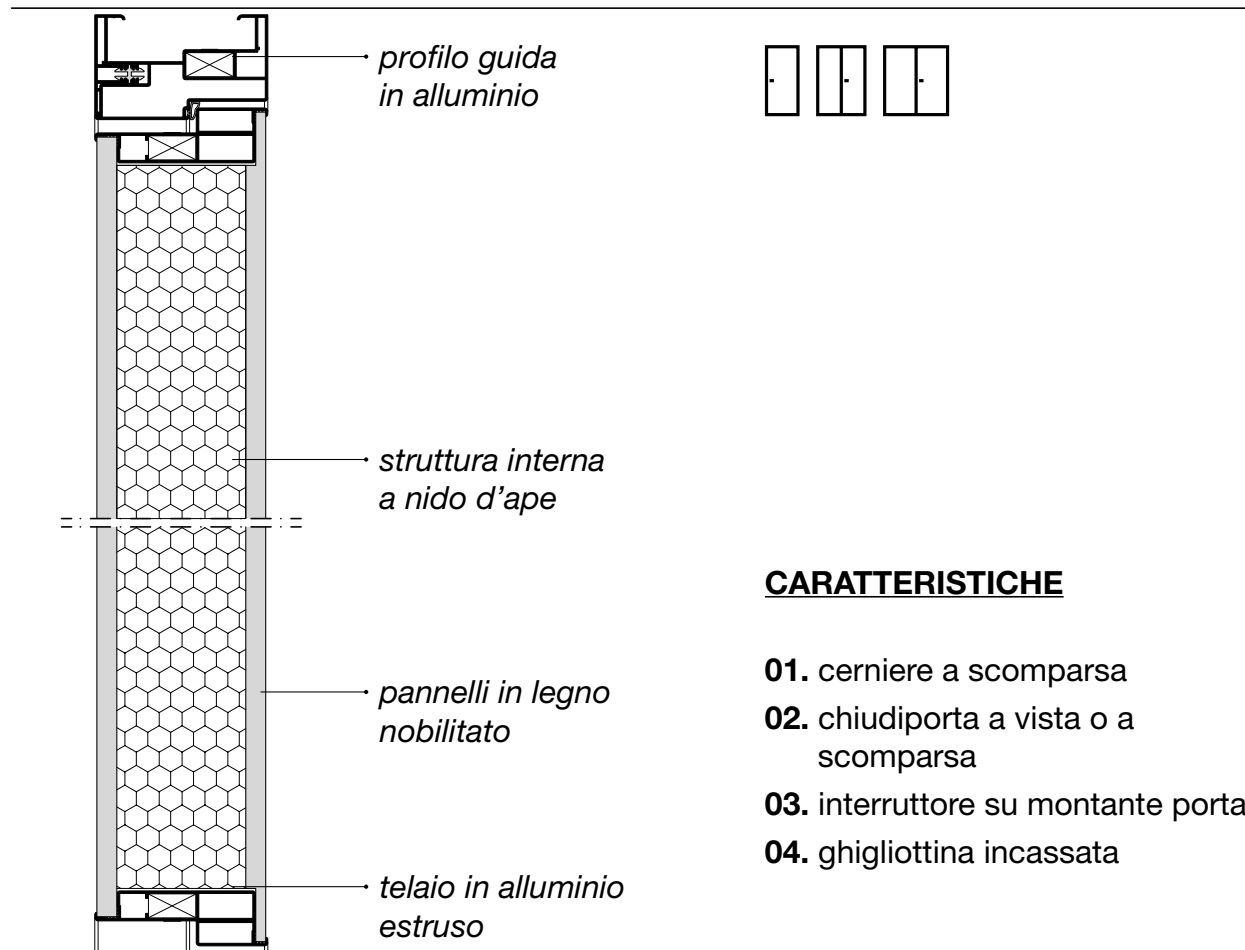

ANTA INTELAIATA CIECA sp. 104 mm

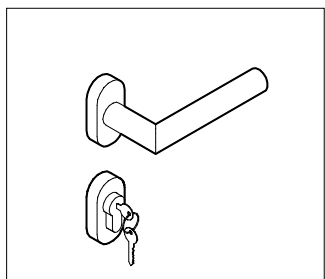

ML5

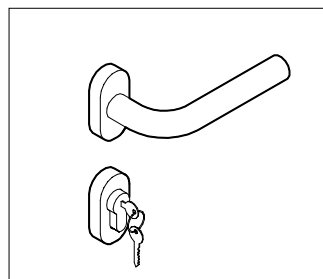

ML6

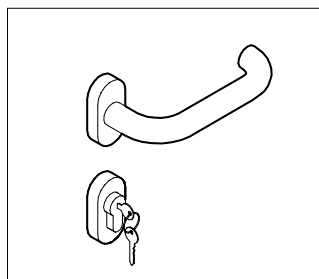

ML7

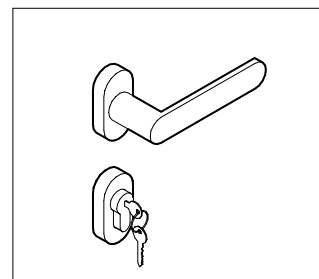

ML8

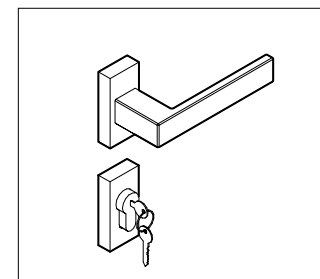

ML9

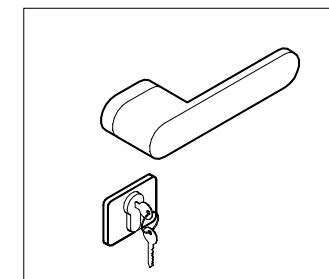

ML10

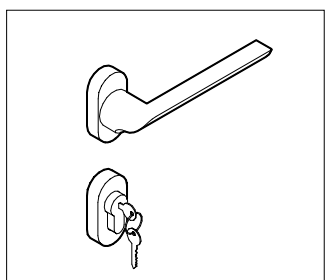

ML11

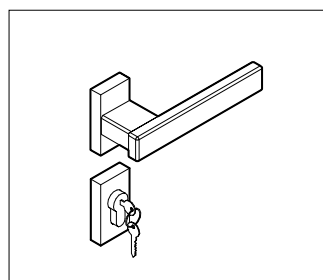

MLQ

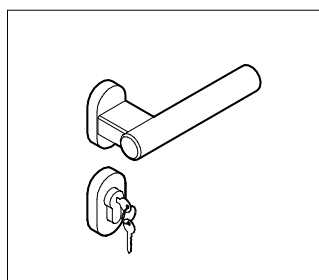

MLT

ANTA INTELAIATA VETRO DOPPIO sp. 104 mm

Porta complanare

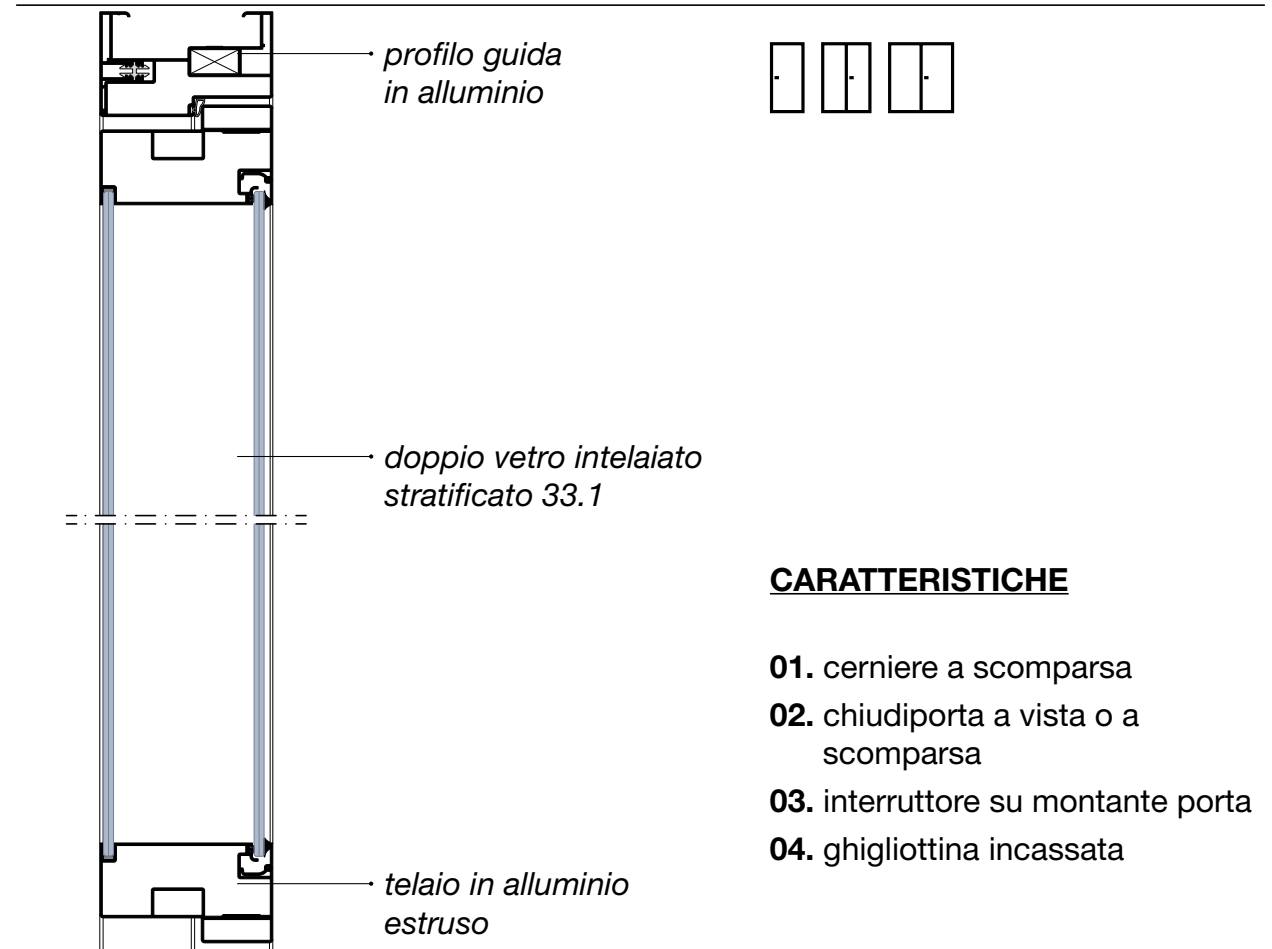

CARATTERISTICHE

- 01. cerniere a scomparsa
- 02. chiudiporta a vista o a scomparsa
- 03. interruttore su montante porta
- 04. ghigliottina incassata

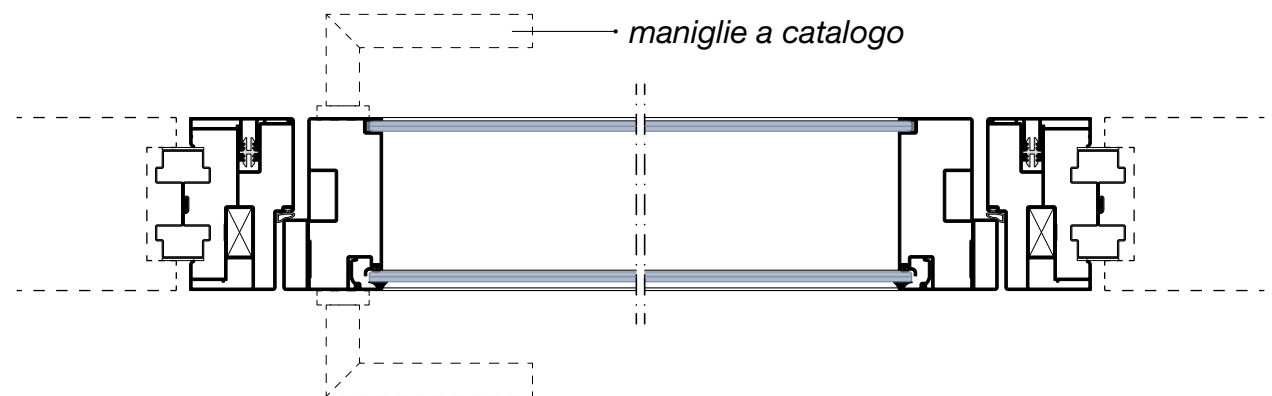

ANTA INTELAIATA VETRO DOPPIO sp. 104 mm

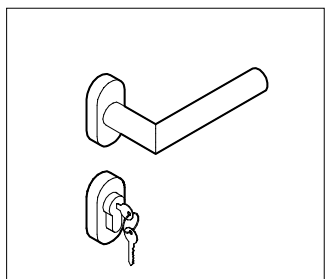

ML5

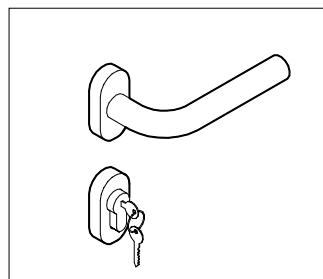

ML6

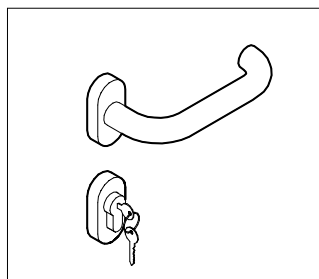

ML7

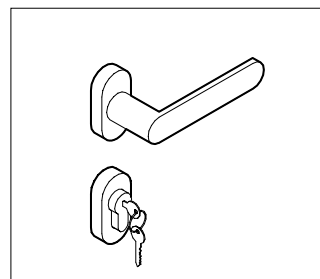

ML8

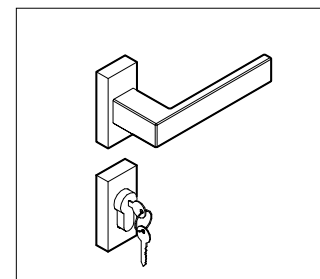

ML9

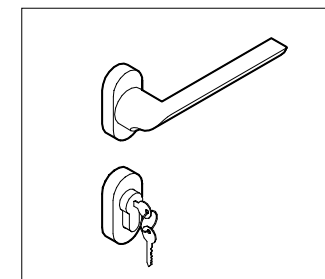

ML11

TELAI PORTE SCORREVOLI



Telaio porta **Metrica Strutturale** su **Metrica D1**

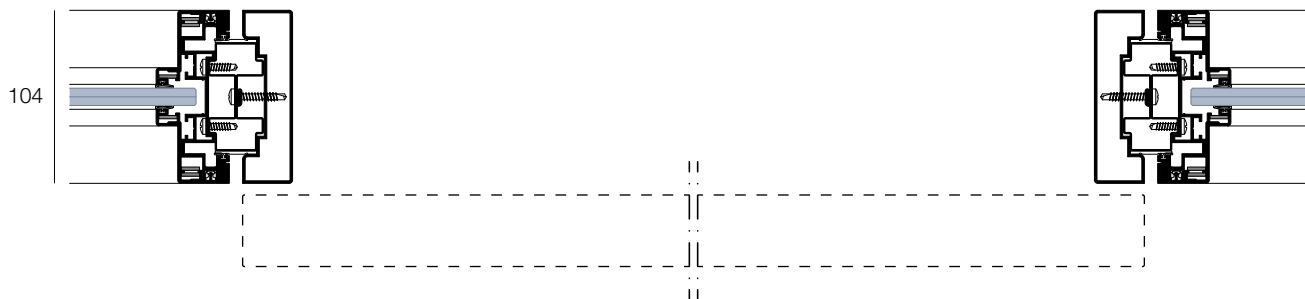

Telaio porta **Metrica Strutturale** su **Metrica D2**

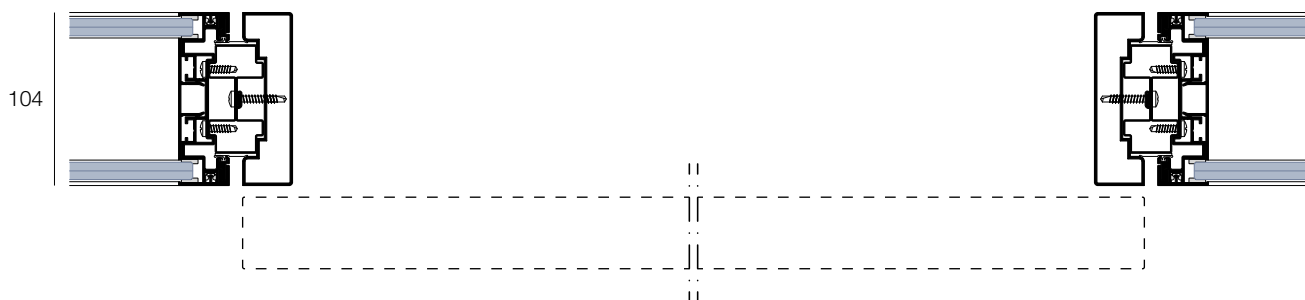

Telaio porta **Metrica Strutturale** su **Metrica Solid**

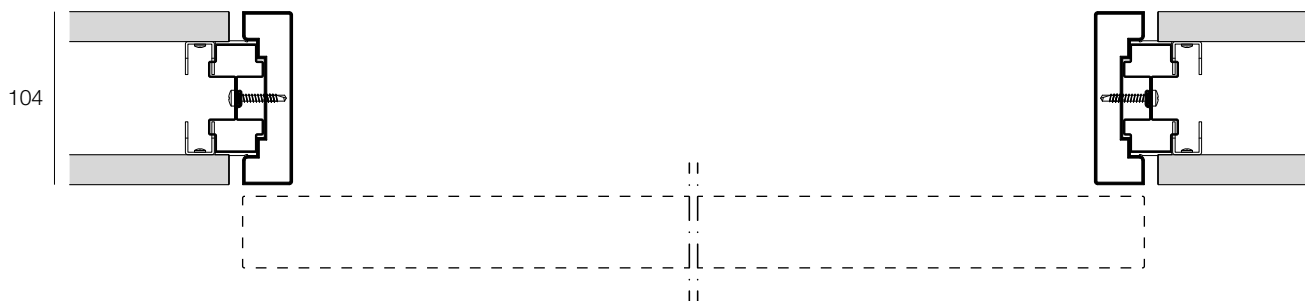

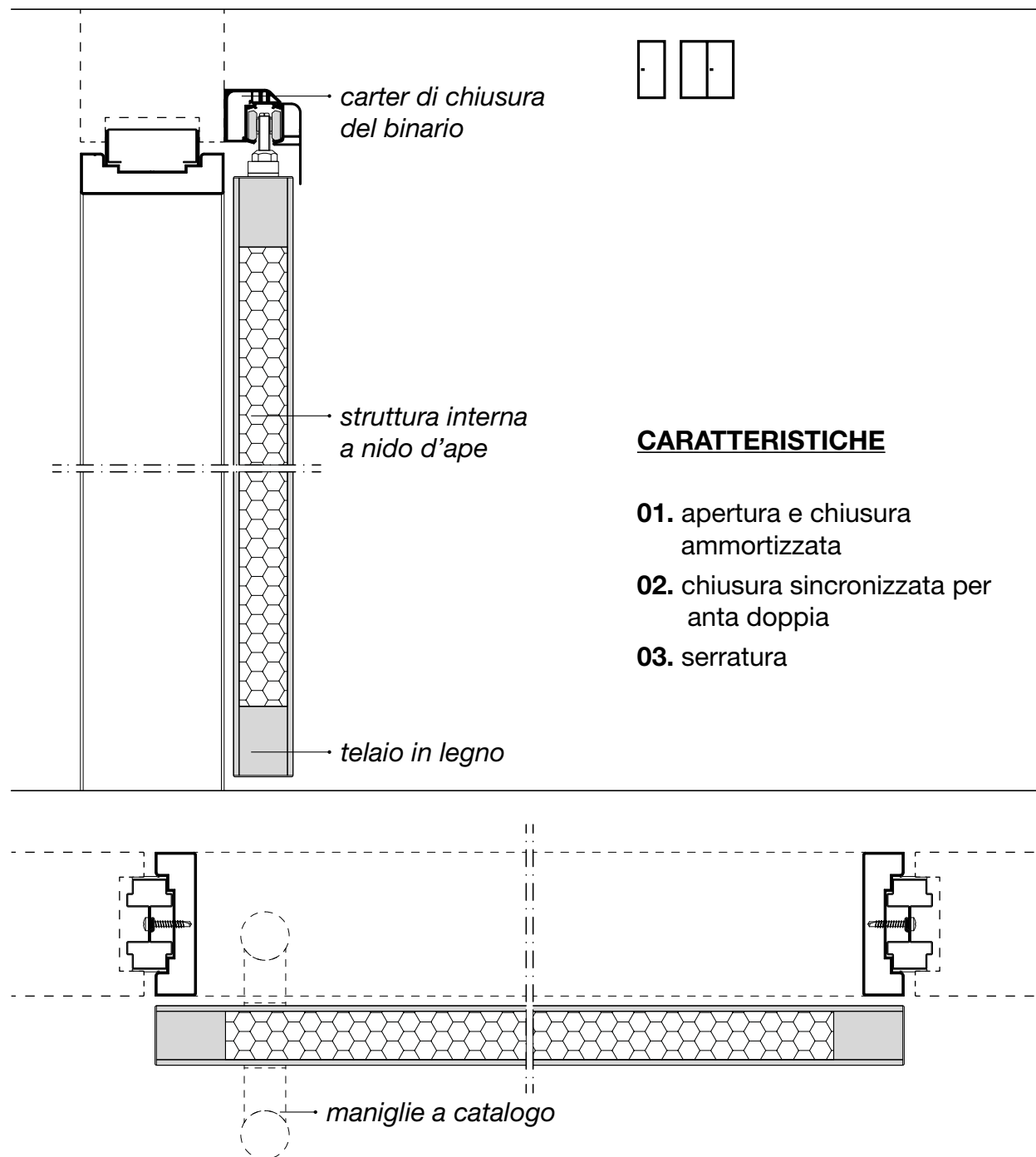

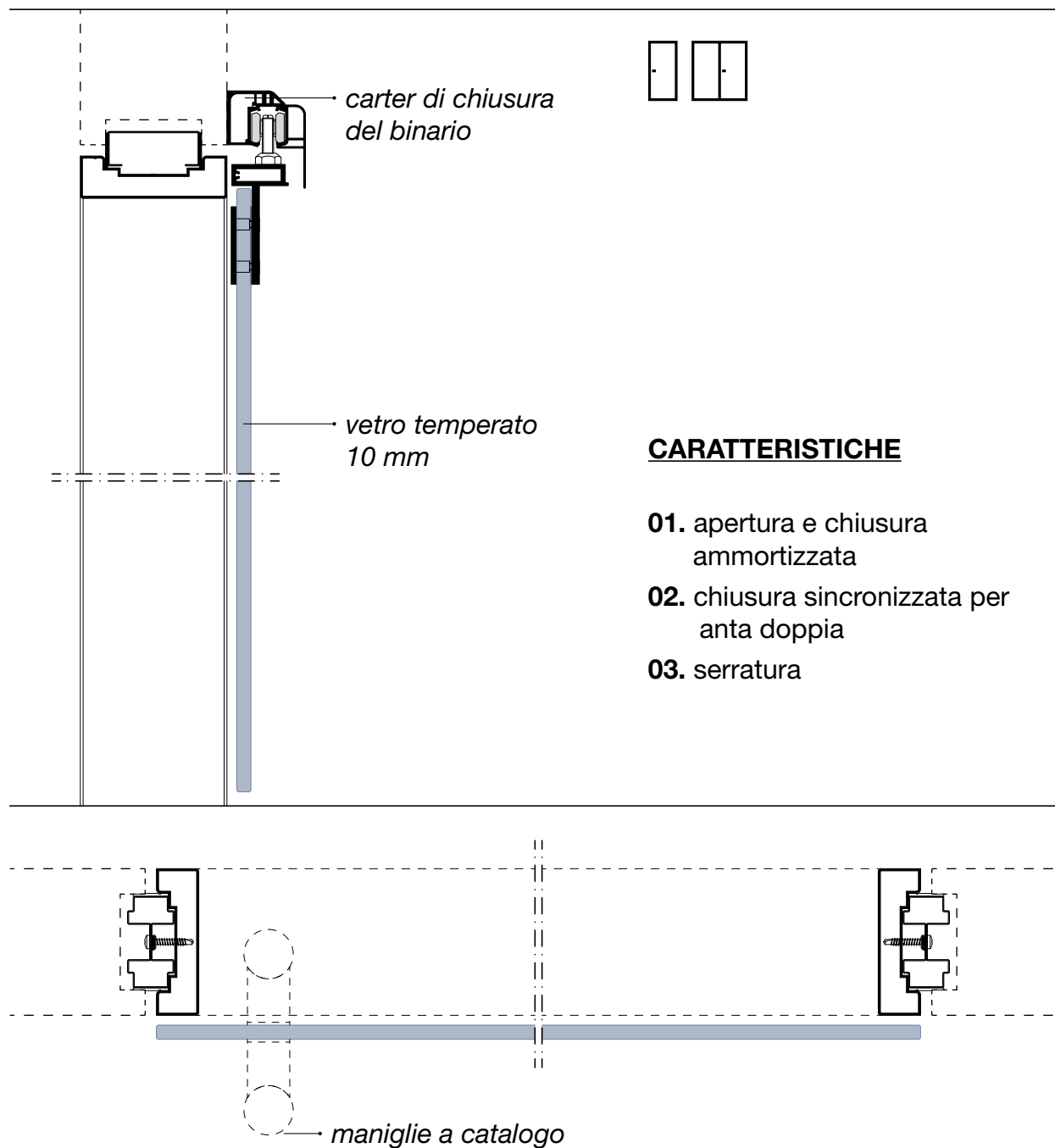

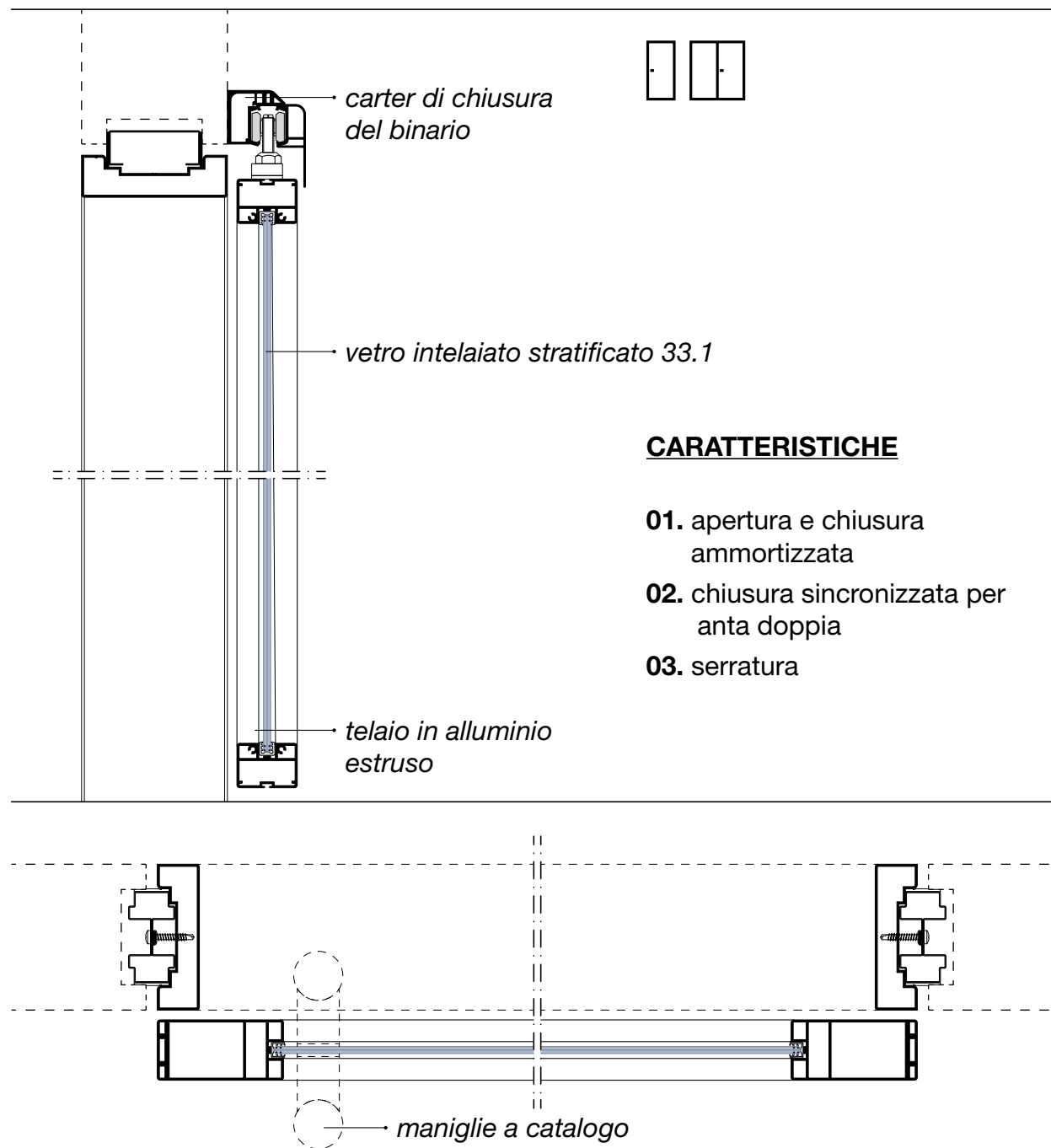

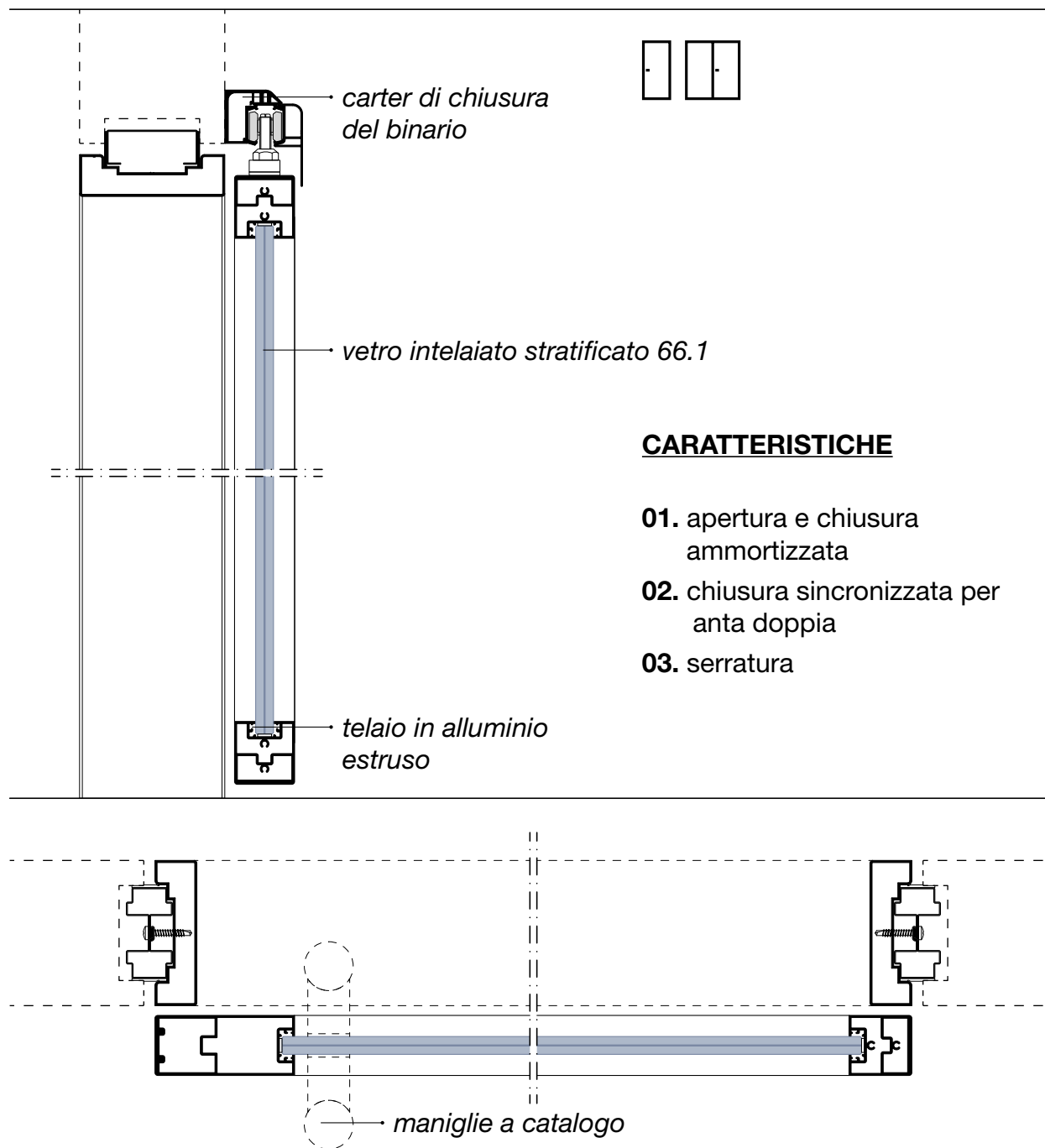

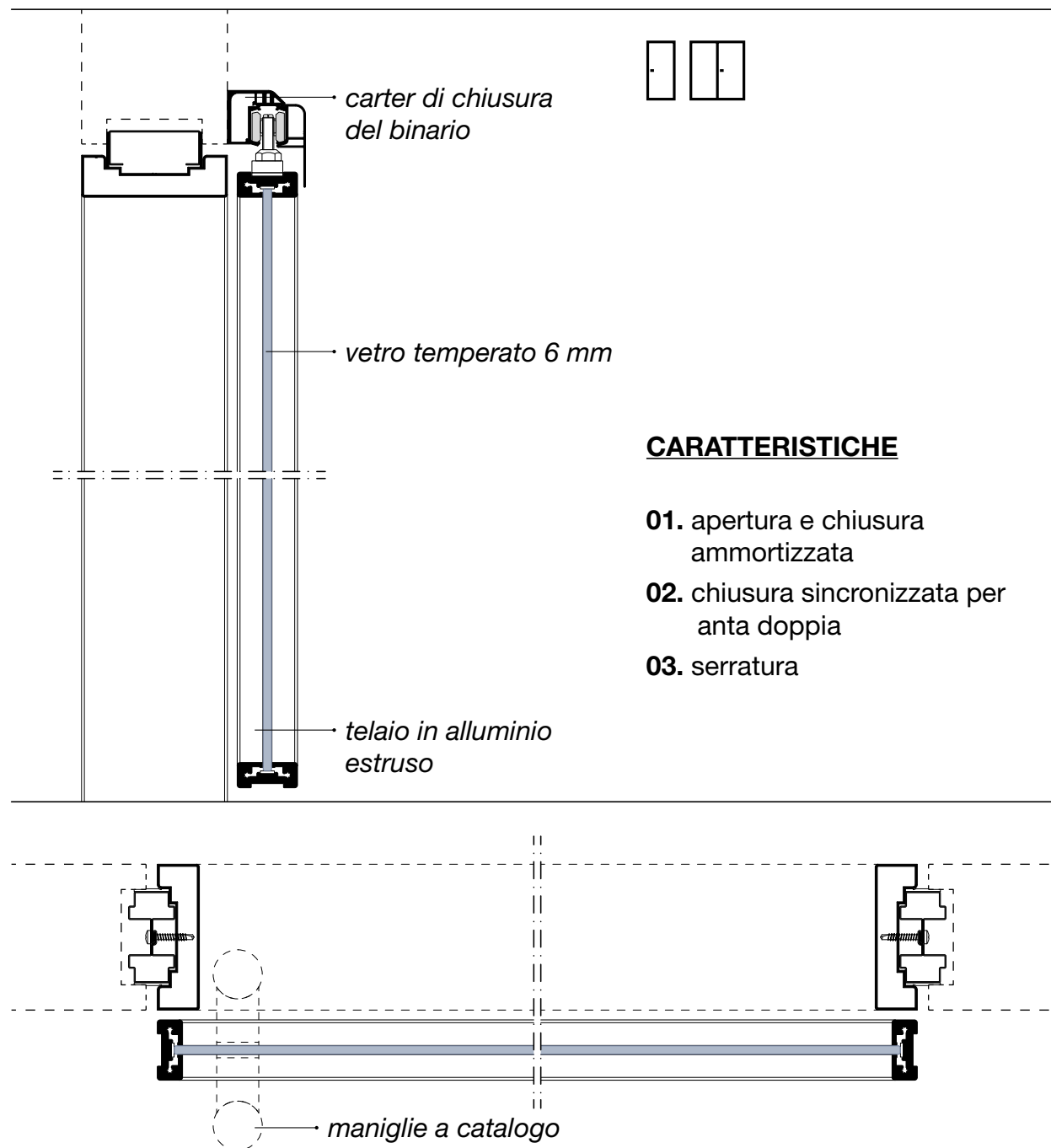
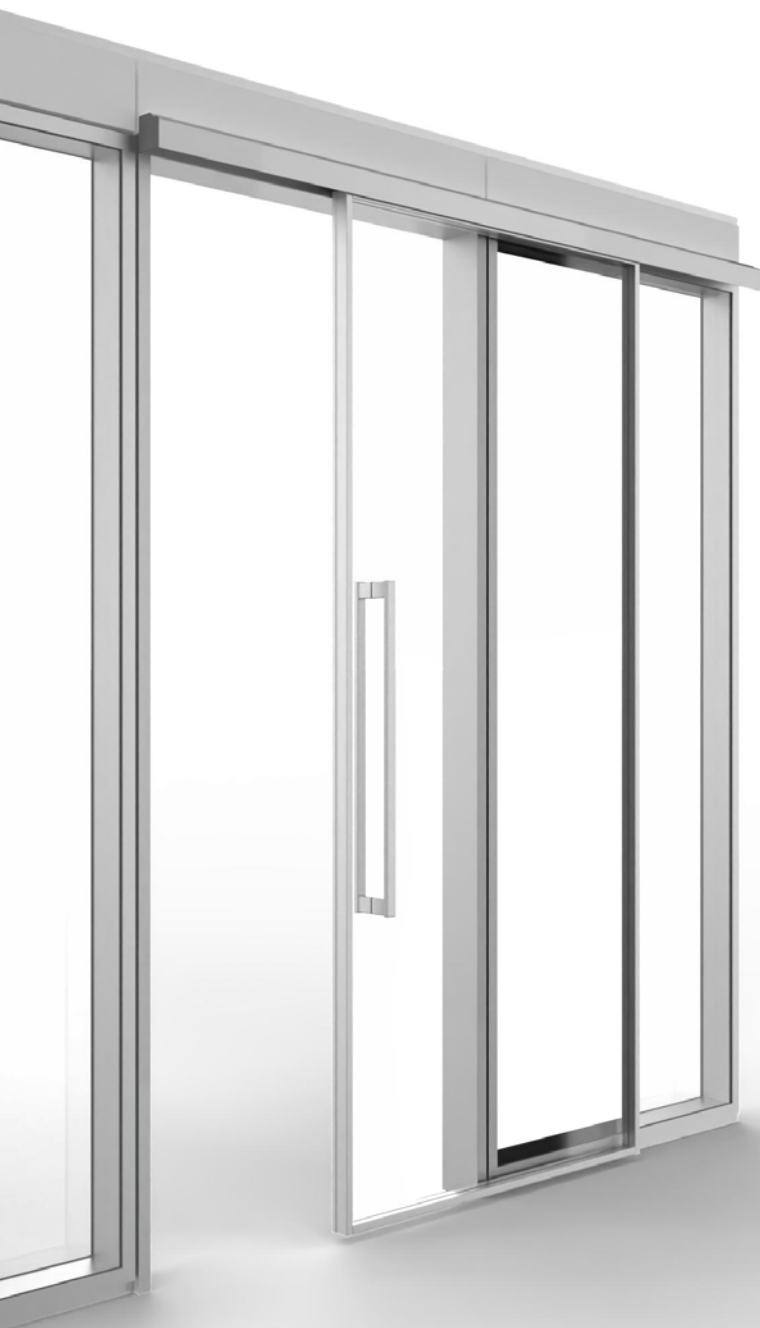

ANTA CIECA_SCORREVOLE INTERNA sp. 38 mm

*solo per Metrica Solid

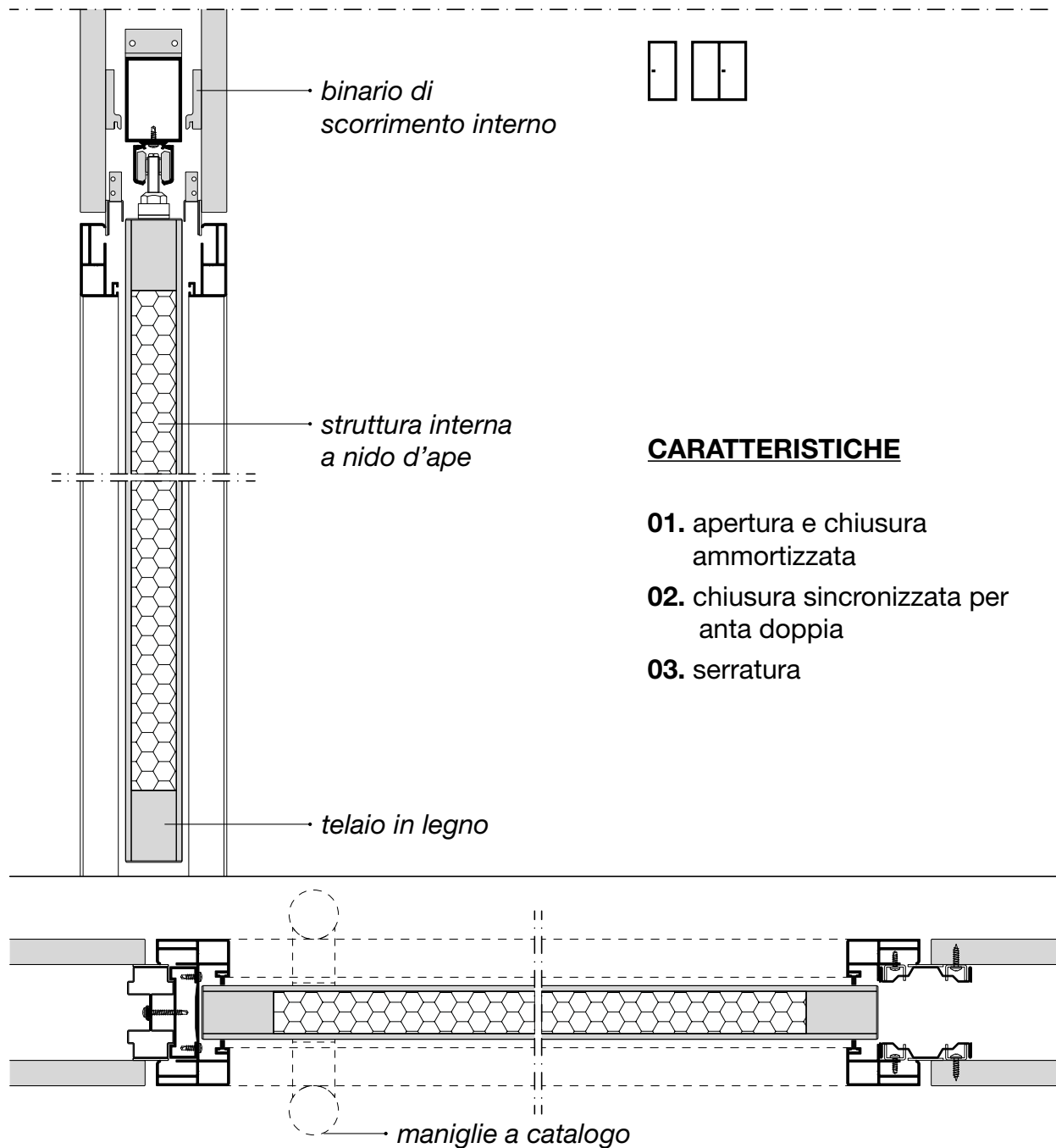

ANTA VETRO TEMPERATO_SCORREVOLE INTERNA sp. 10 mm

*solo per Metrica Solid

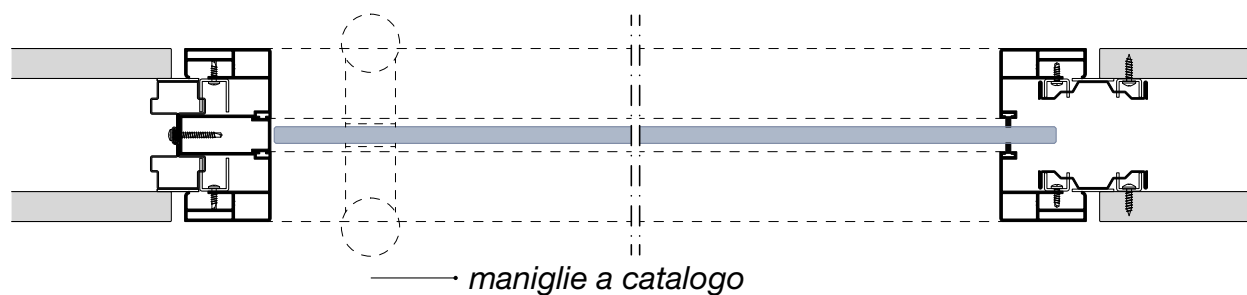
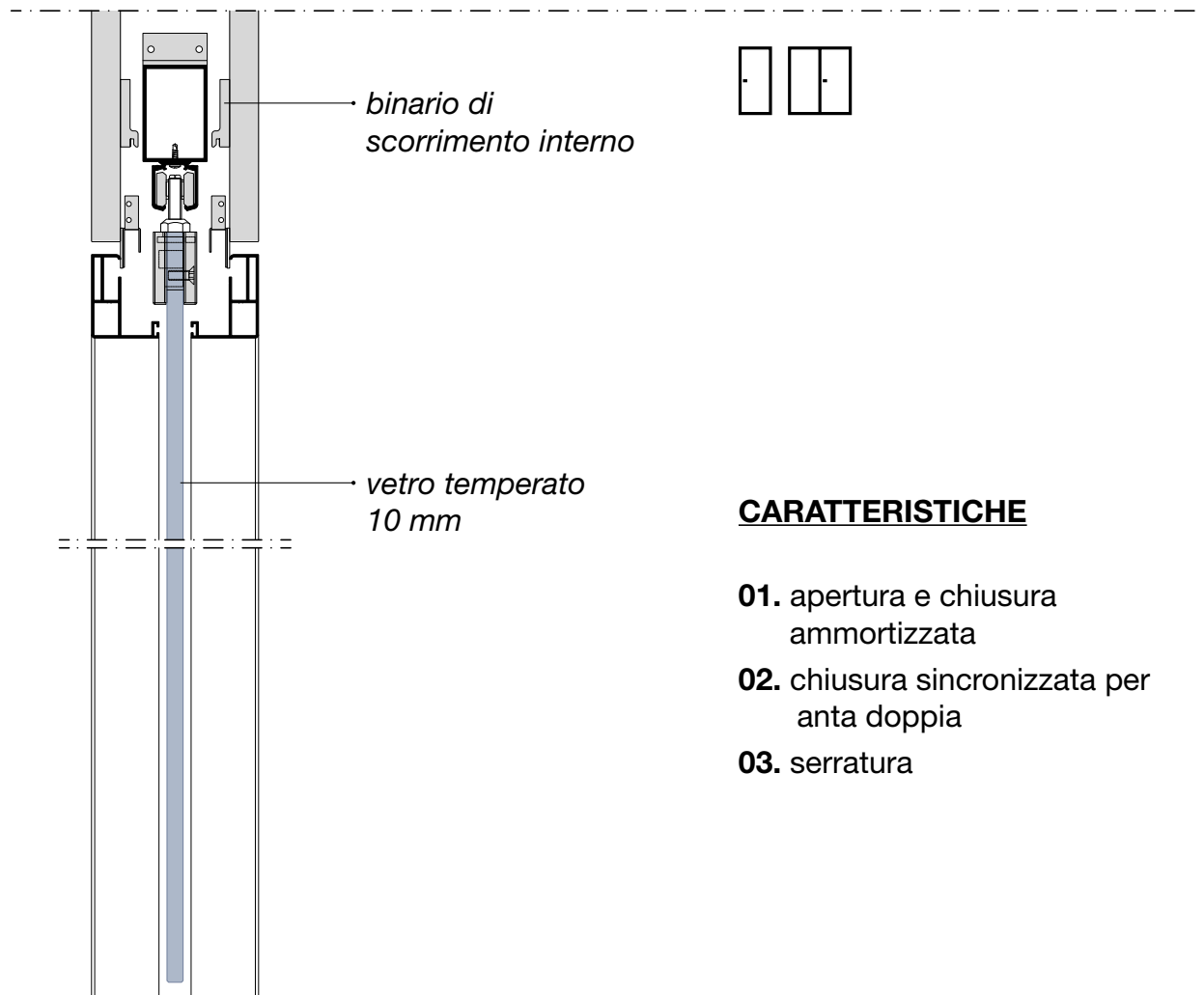
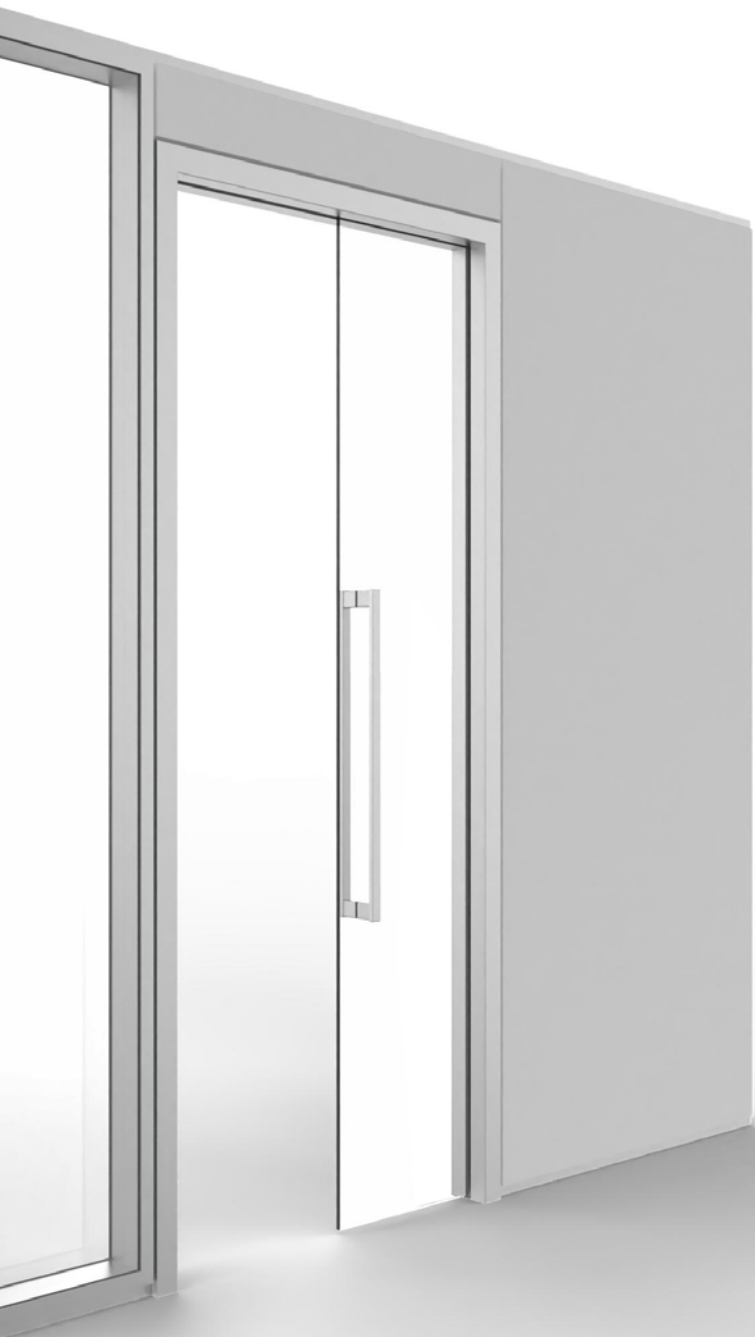

TELAI PORTE BATTENTI

Metrica F



Telaio porta **Metrica F** su **Metrica F1**

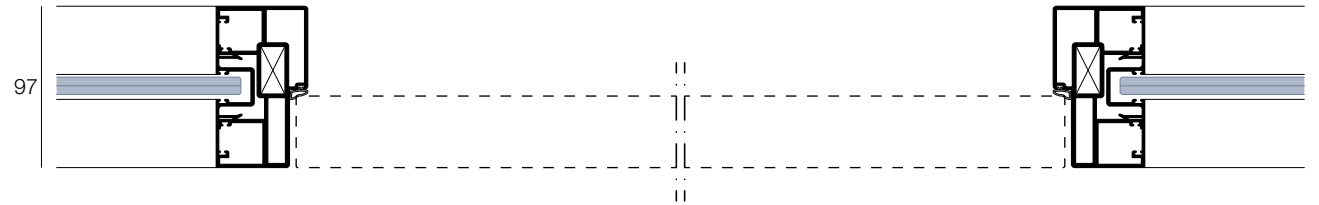

Telaio porta **Metrica F** su **Metrica FA**

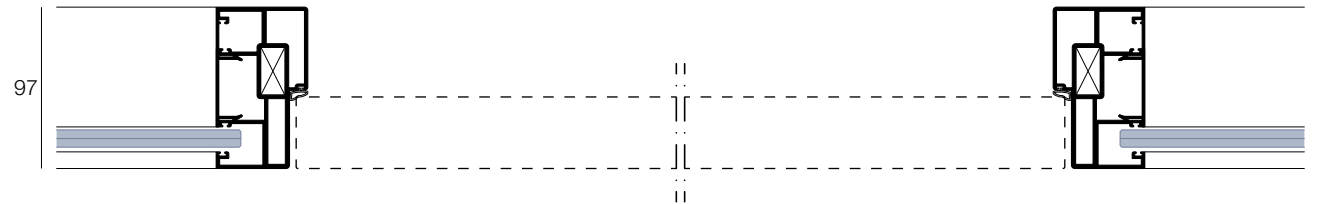

Telaio porta **Metrica F** su **Metrica F2**

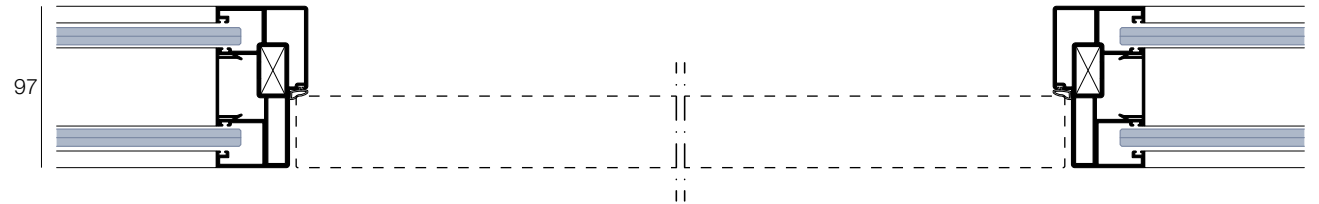

Telaio porta **Metrica F** su **Metrica F Solid**

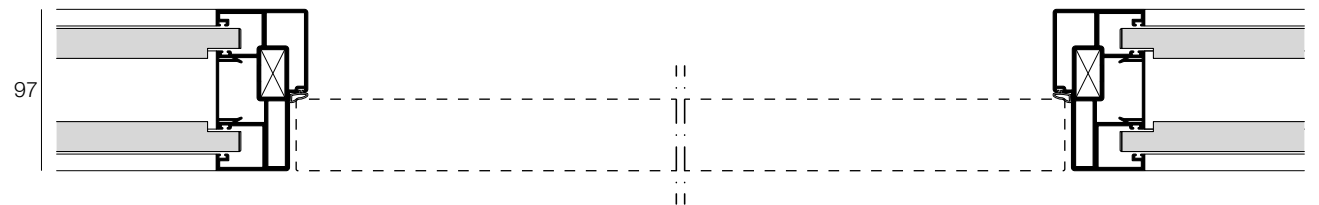

ANTA CIECA sp. 43 mm

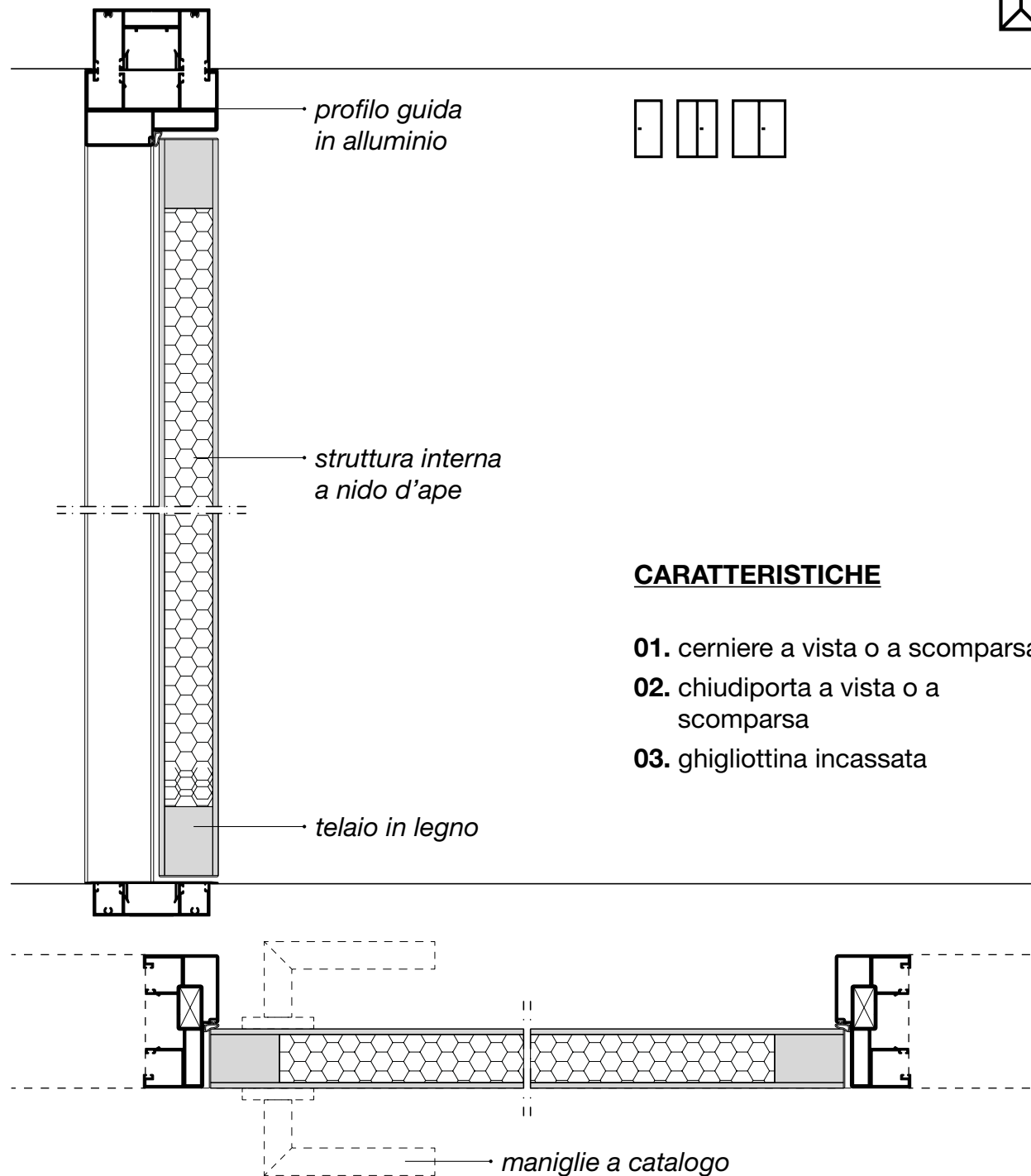

ANTA CIECA sp. 43 mm

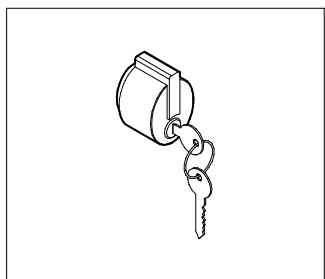

ML1

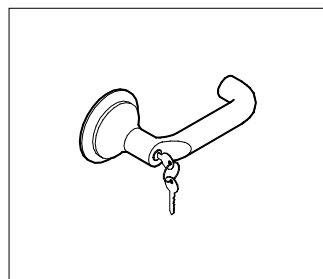

ML4

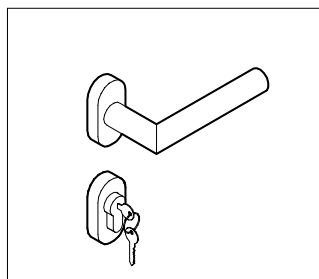

ML5

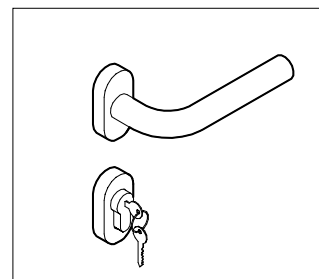

ML6

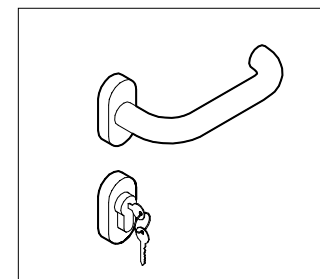

ML7

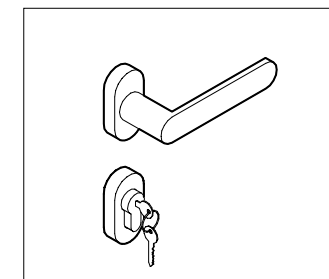

ML8

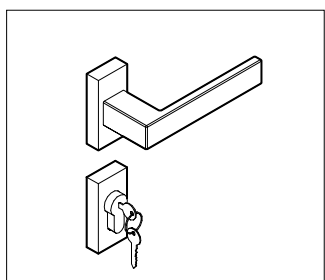

ML9

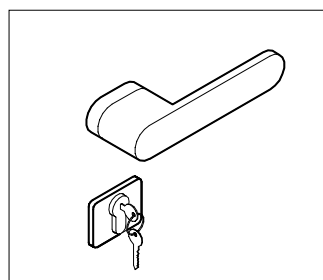

ML10

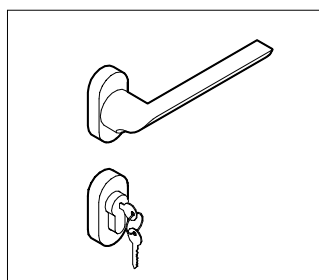

ML11

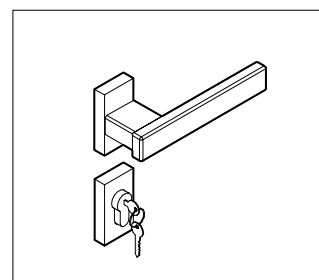

MLQ

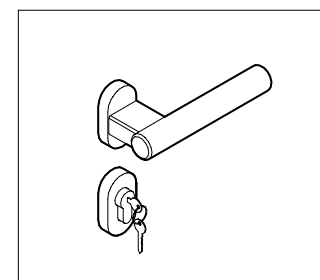

MLT

ANTA VETRO TEMPERATO sp. 10 mm

Cerniere a vista

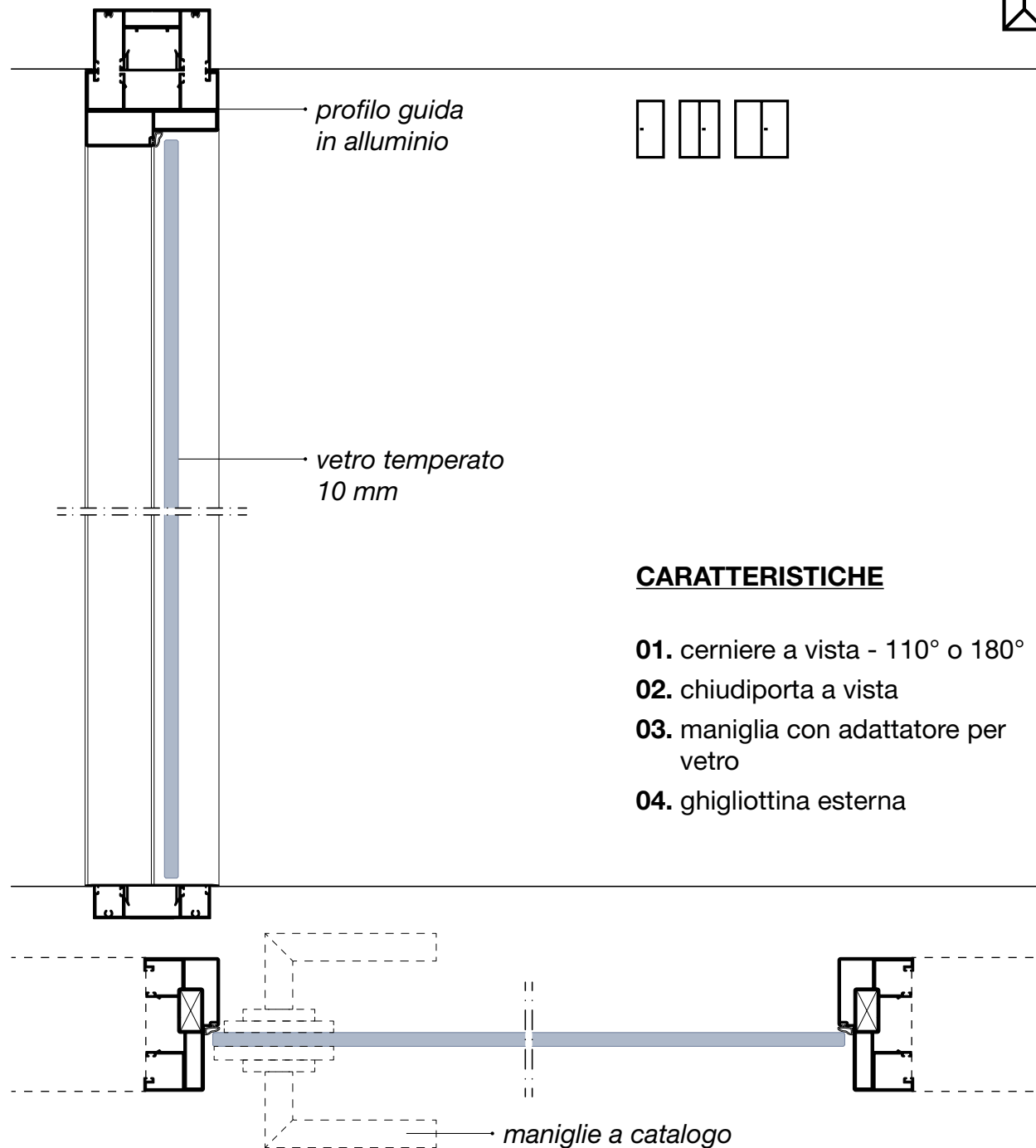

ANTA VETRO TEMPERATO sp. 10 mm

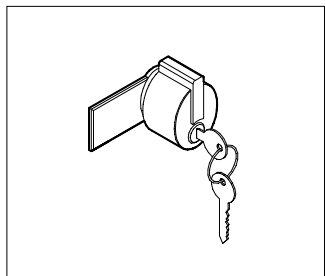

MC1

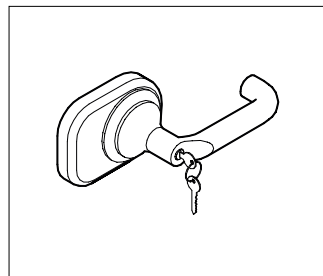

MC4

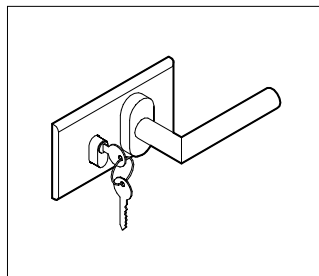

MC5

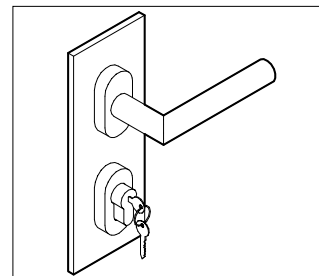

MC5V

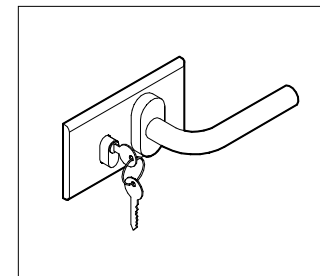

MC6

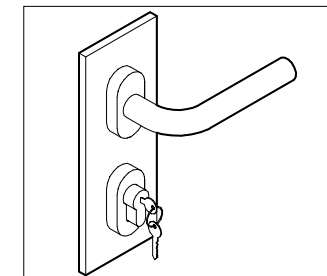

MC6V

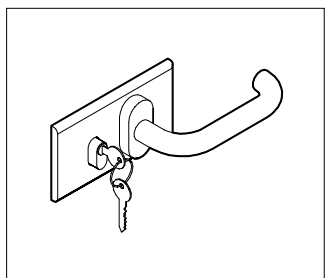

MC7

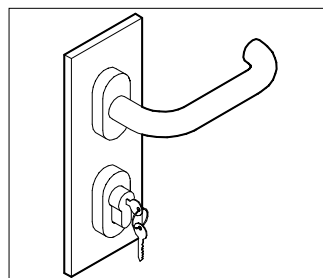

MC7V

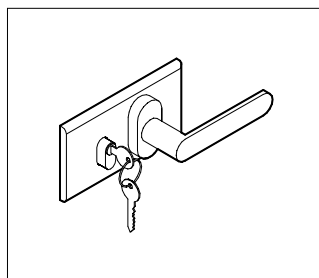

MC8

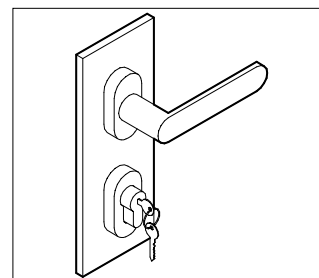

MC8V

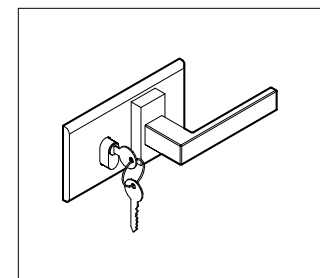

MC9

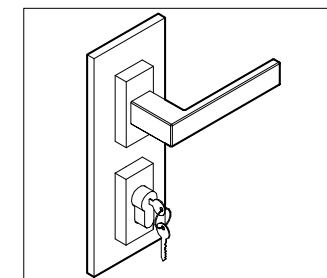

MC9V

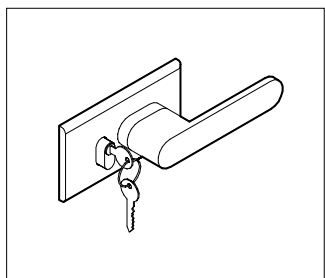

MC10

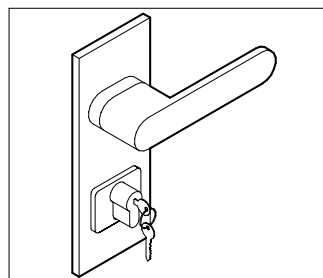

MC10V

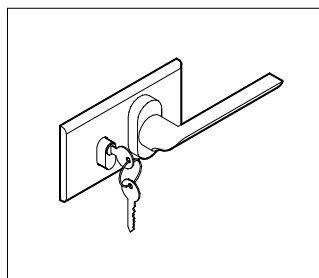

MC11

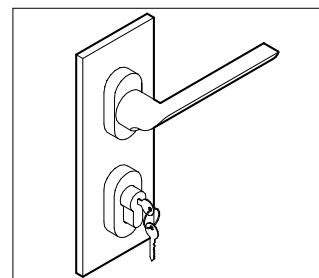

MC11V

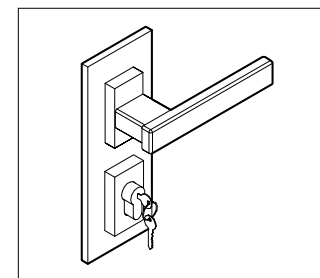

MCQ

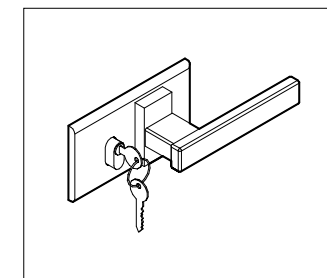

MCQO

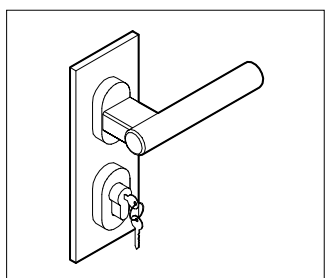

MCT

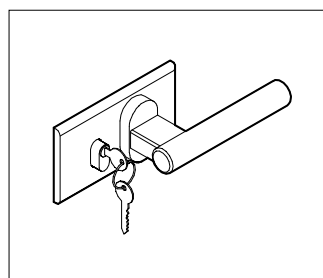

MCTO

ANTA VETRO TEMPERATO sp. 10 mm

Cerniera continua

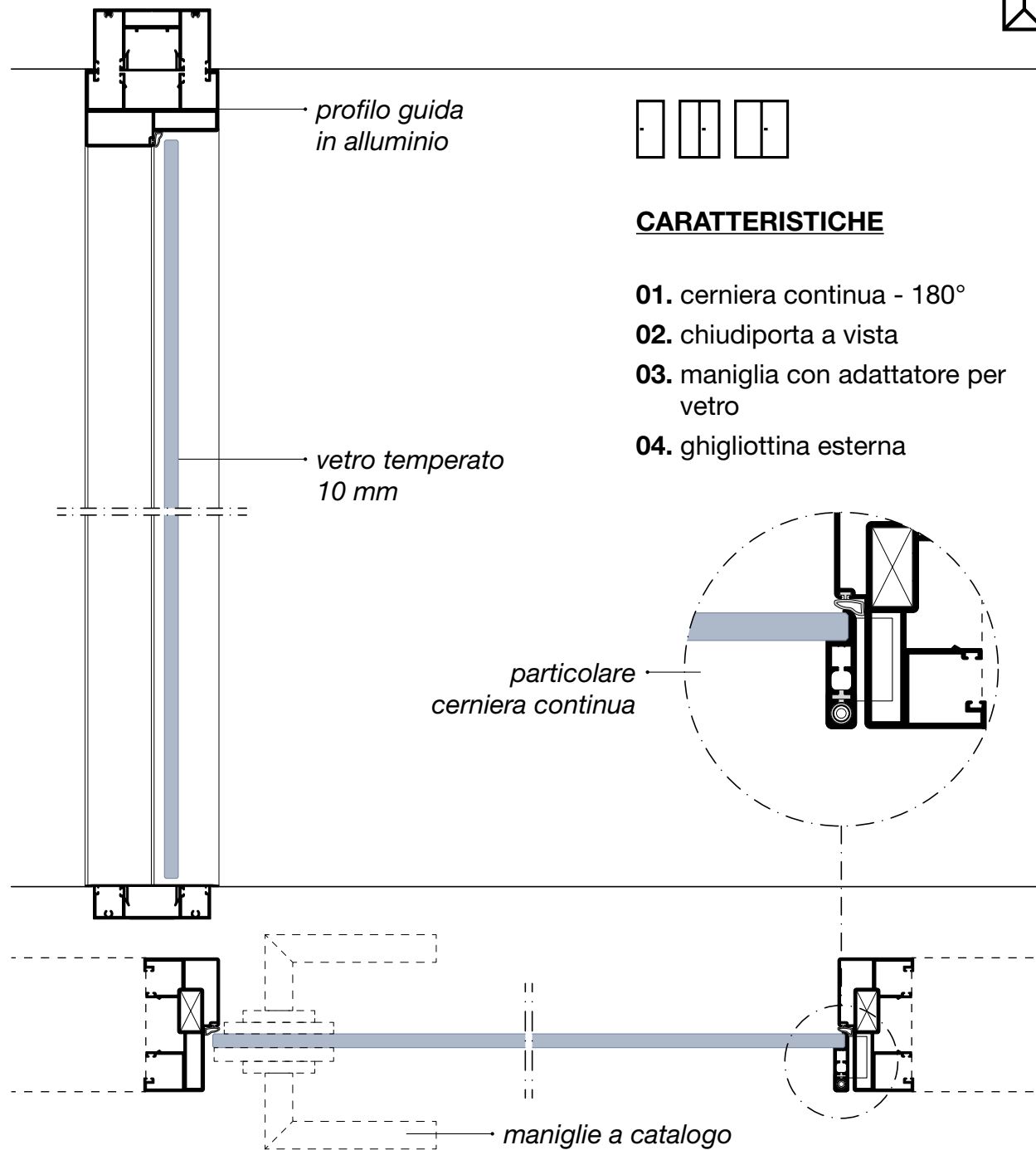
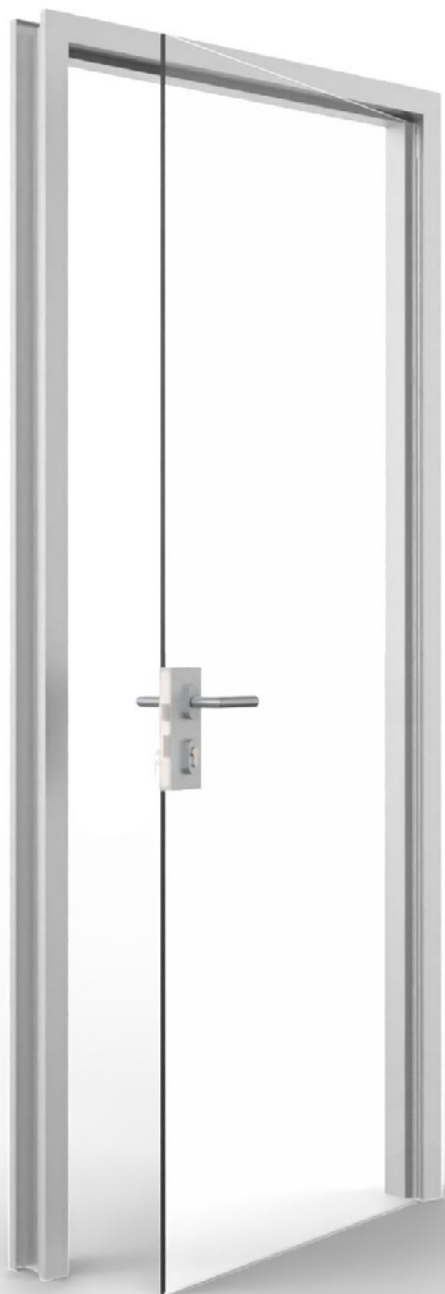

ANTA VETRO TEMPERATO sp. 10 mm

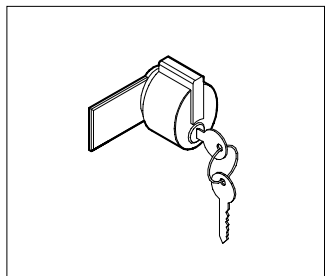

MC1

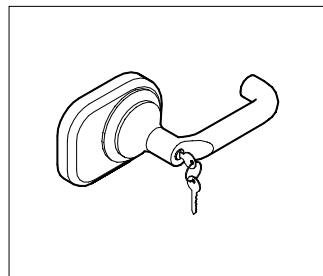

MC4

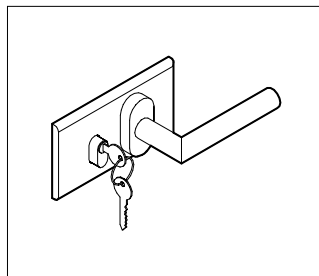

MC5

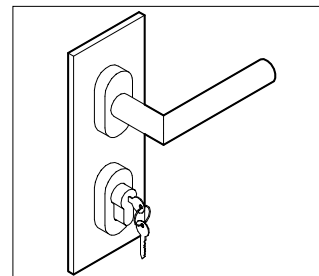

MC5V

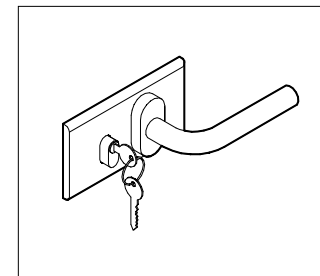

MC6

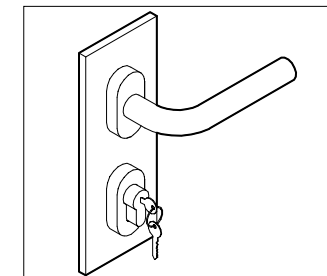

MC6V

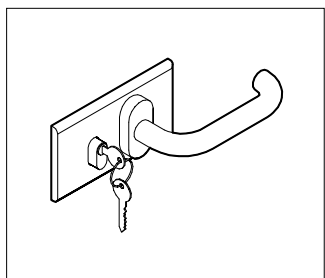

MC7

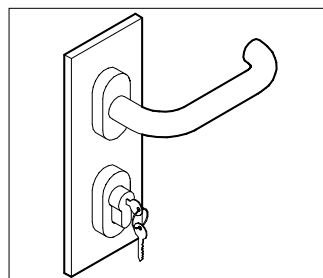

MC7V

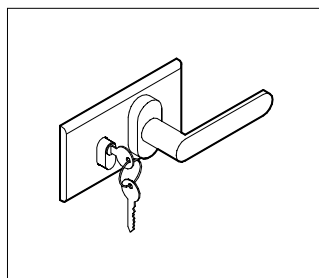

MC8

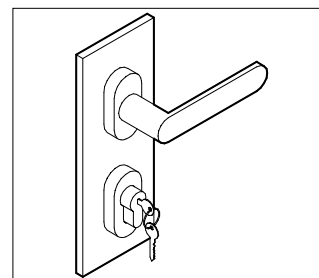

MC8V

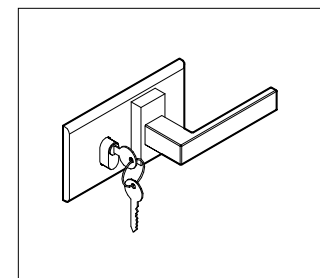

MC9

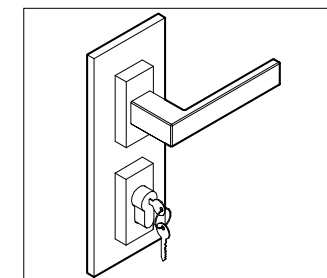

MC9V

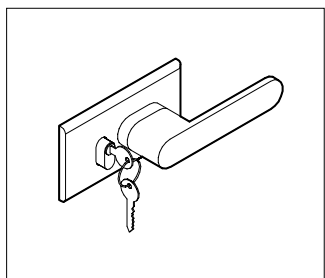

MC10

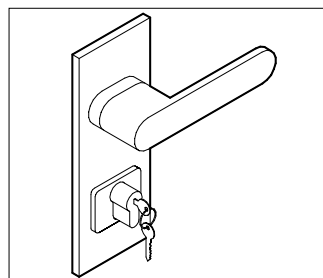

MC10V

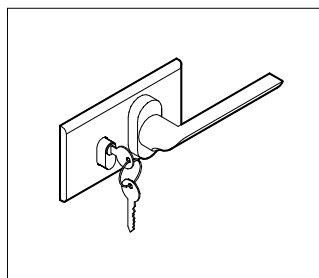

MC11

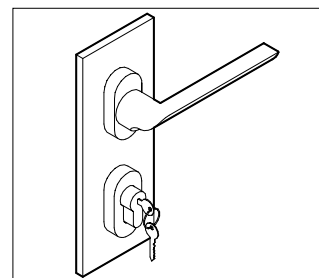

MC11V

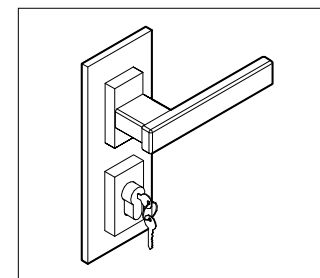

MCQ

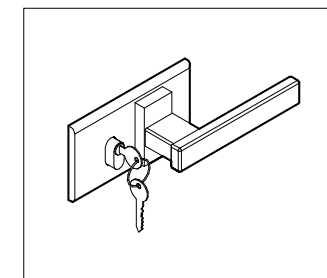

MCQO

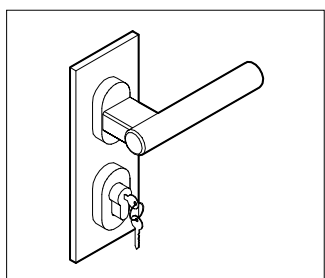

MCT

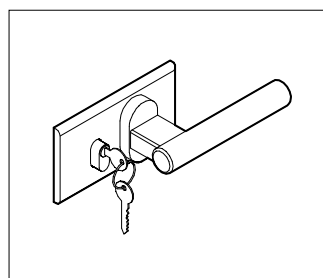

MCTO

ANTA INTELAIATA CIECA sp. 97 mm

Porta complanare

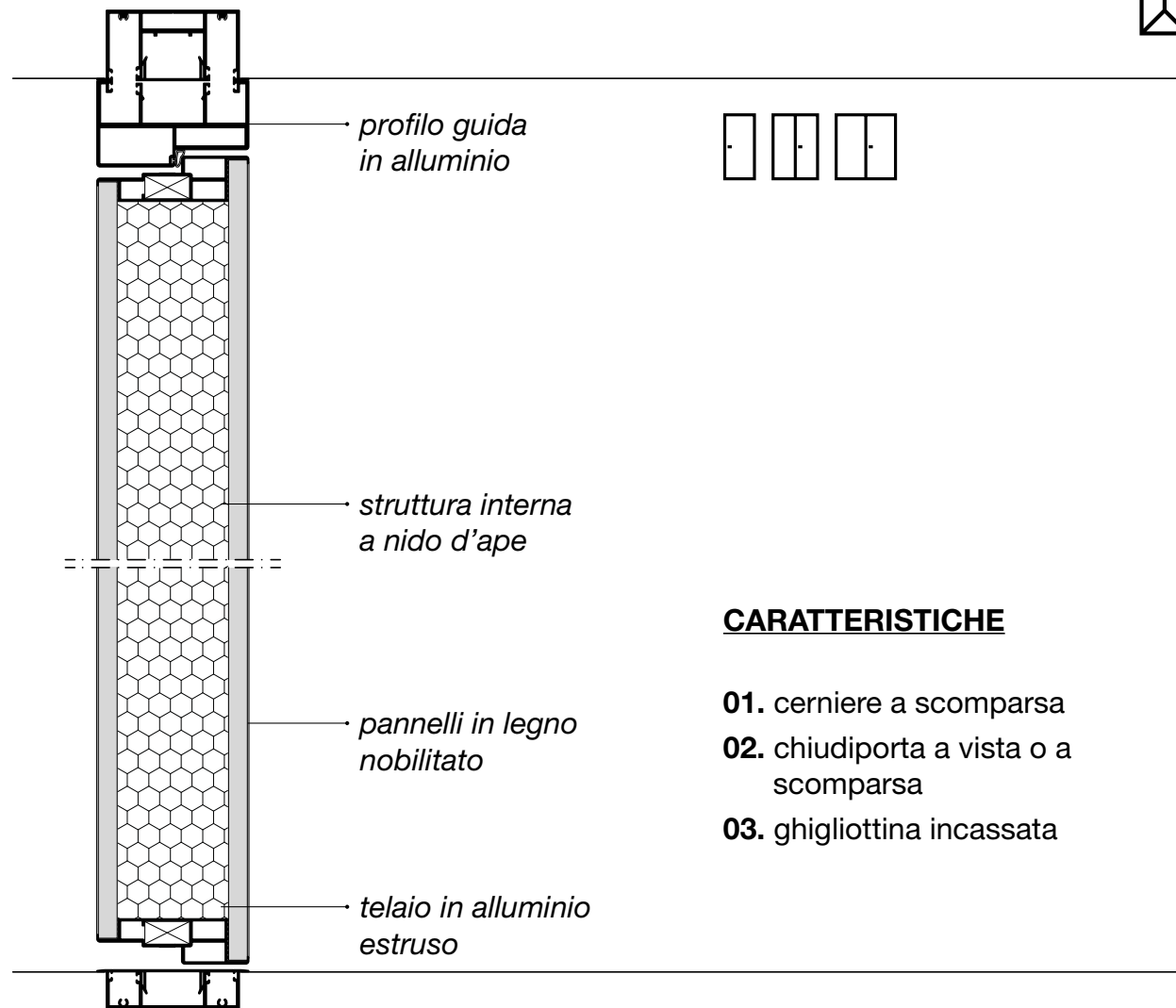

CARATTERISTICHE

- 01. cerniere a scomparsa
- 02. chiudiporta a vista o a scomparsa
- 03. ghigliottina incassata

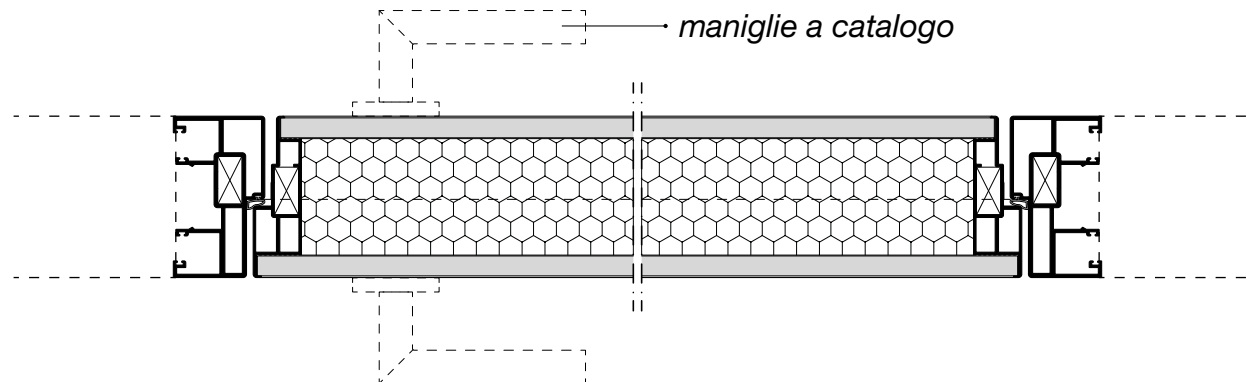

ANTA INTELAIATA CIECA sp. 97 mm

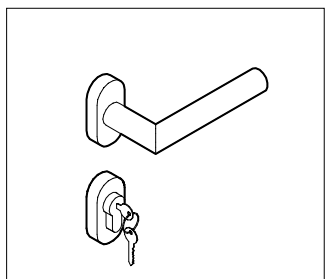

ML5

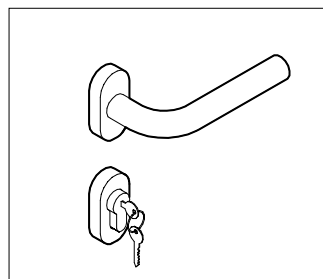

ML6

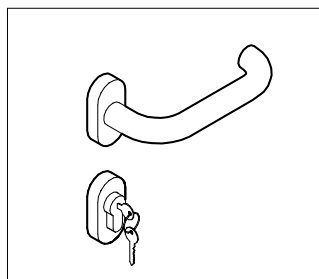

ML7

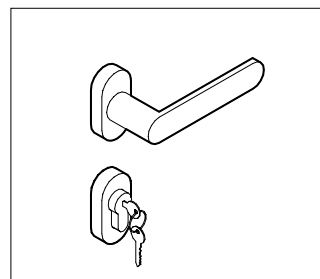

ML8

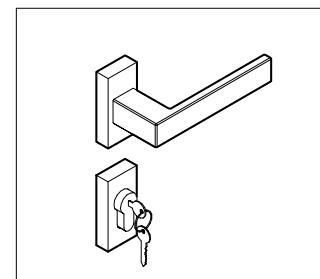

ML9

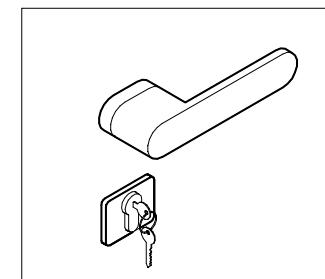

ML10

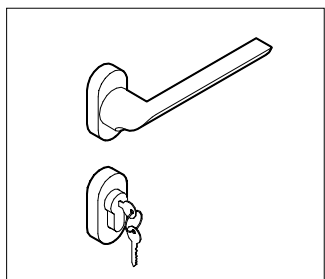

ML11

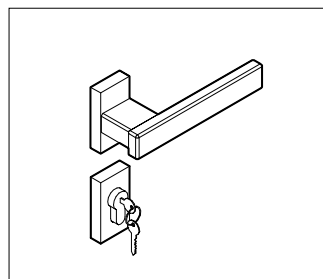

MLQ

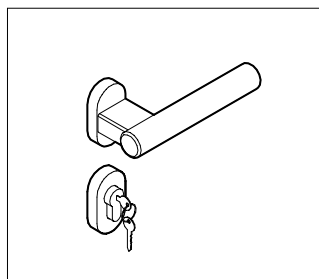

MLT

ANTA INTELAIATA VETRO DOPPIO sp. 97 mm

Porta complanare

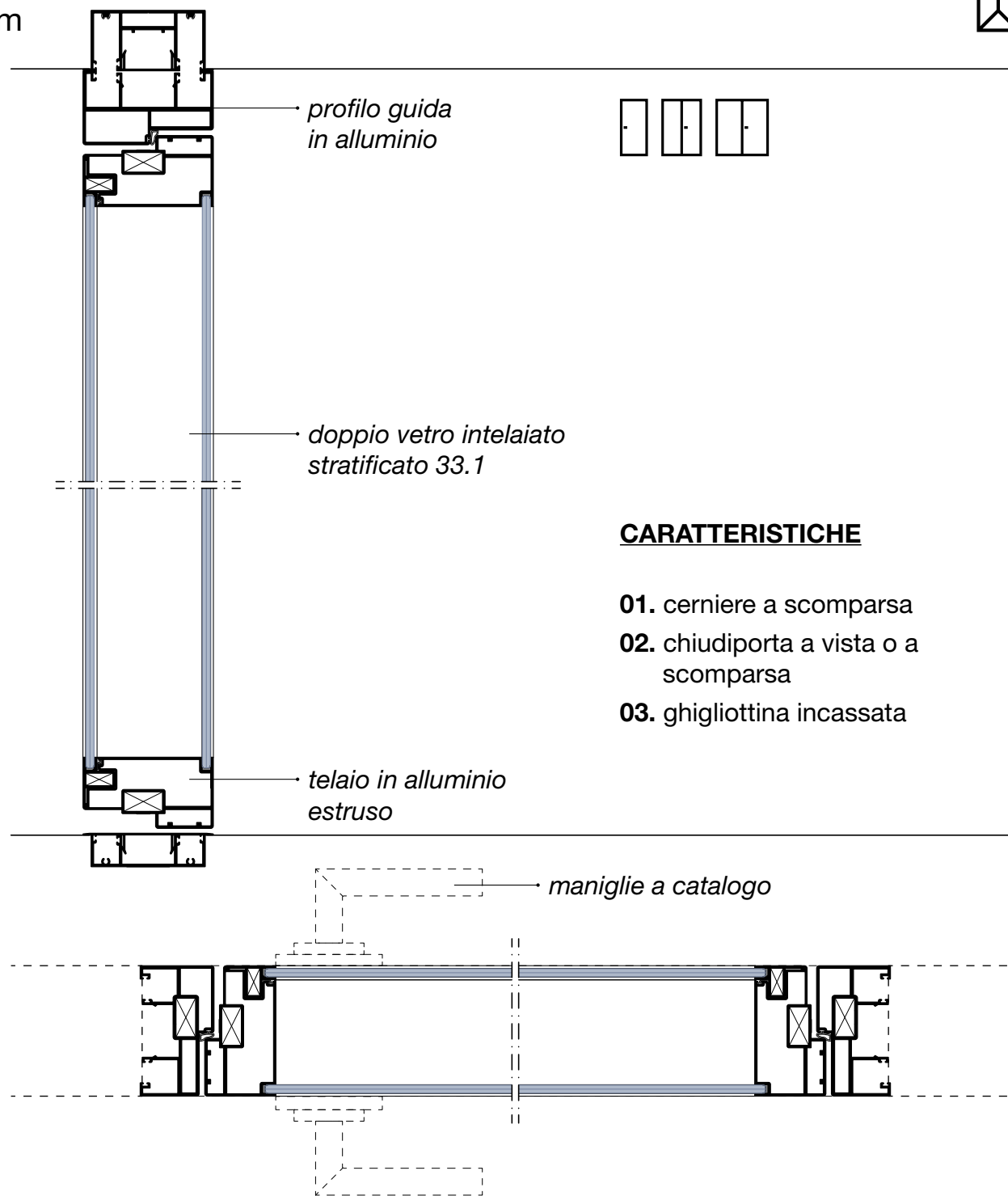

ANTA INTELAIATA VETRO DOPPIO sp. 97 mm

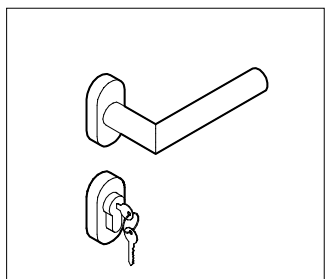

ML5

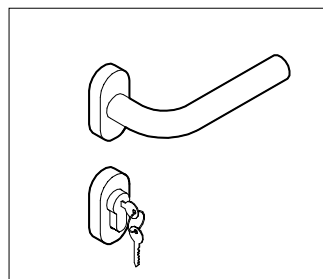

ML6

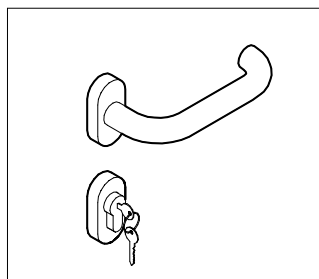

ML7

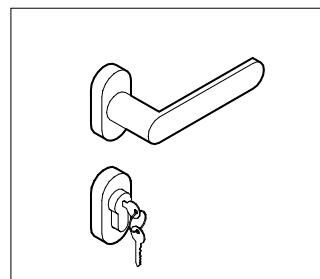

ML8

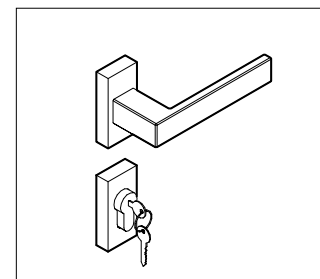

ML9

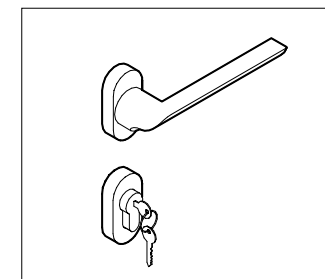

ML11

ANTA INTELAIATA sp. 25 mm

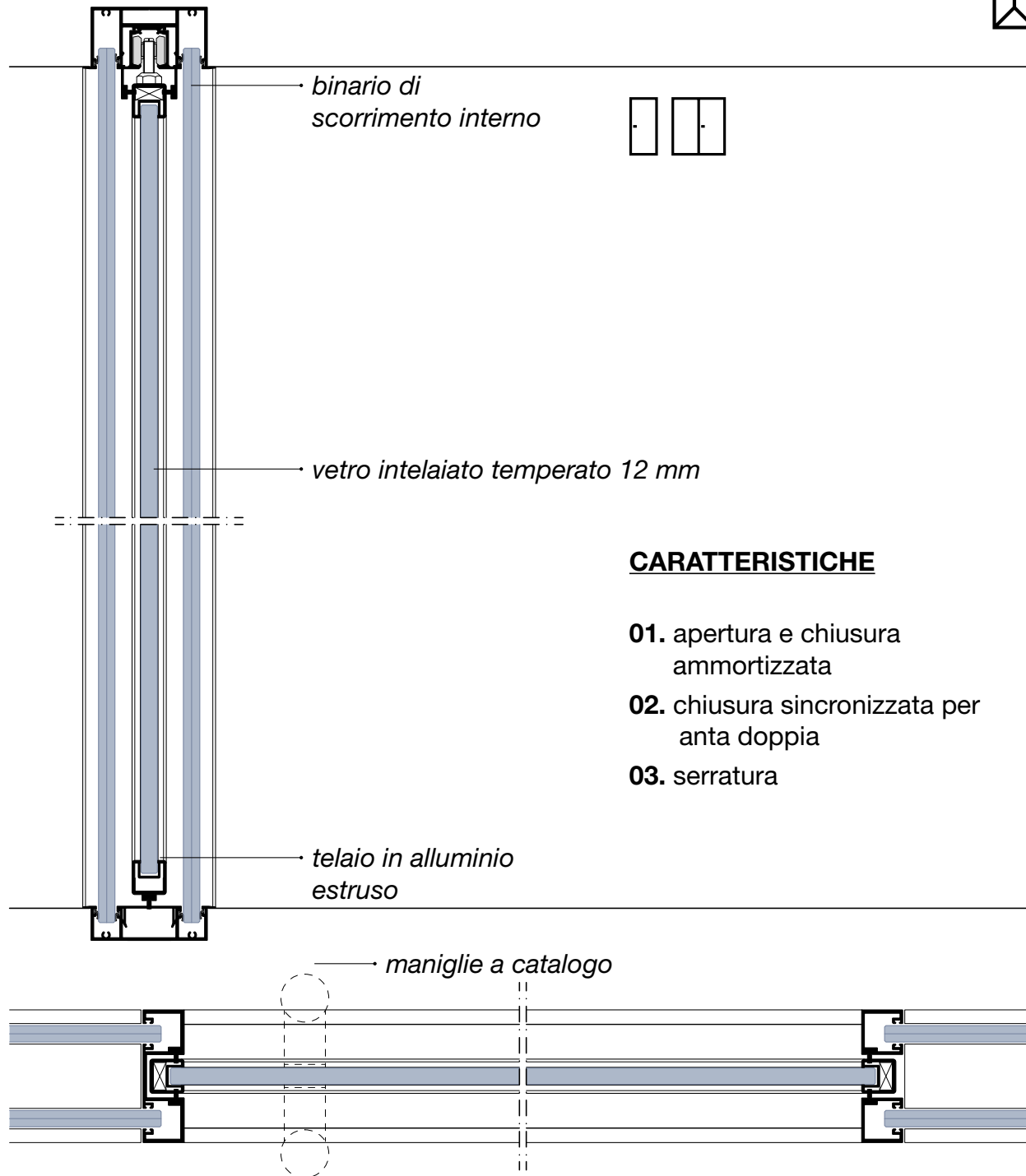

Porte in vetro



ACCIAIO

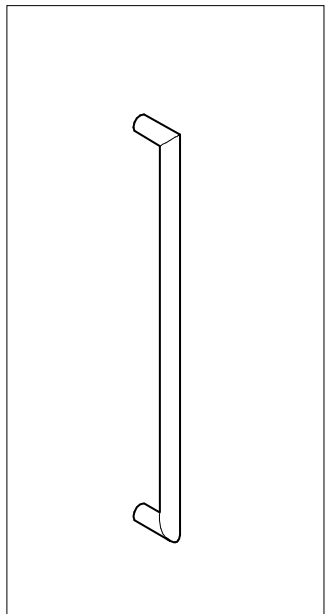

MPOMGH1_H2_H3

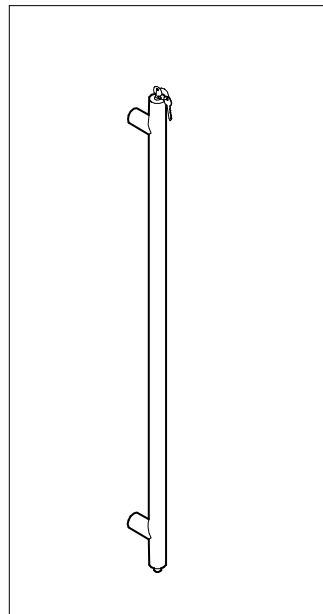

MPOM2

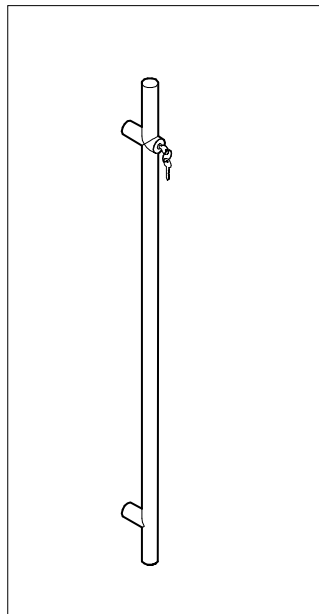

MPOM3

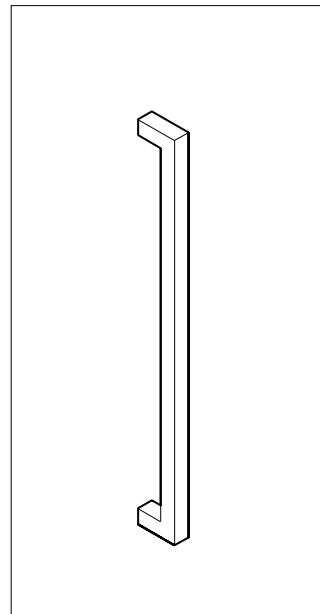

MPOMGH1Q_GH2Q_GH3Q

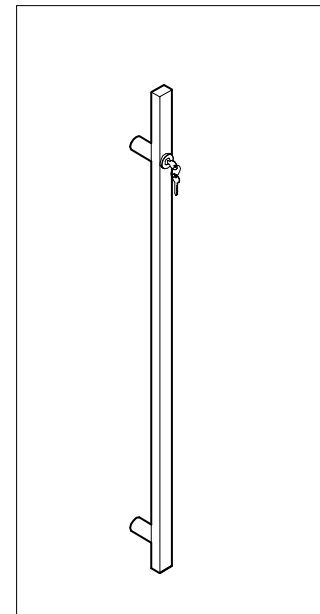

MPOM3Q

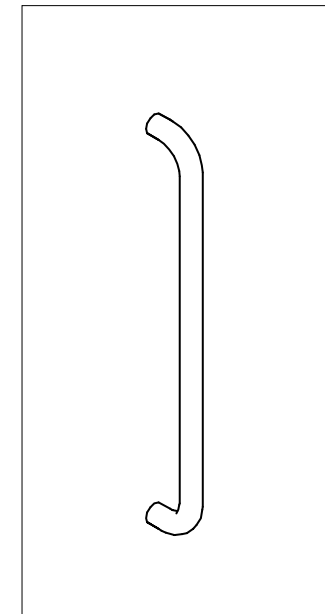

MPOM8

ALLUMINIO

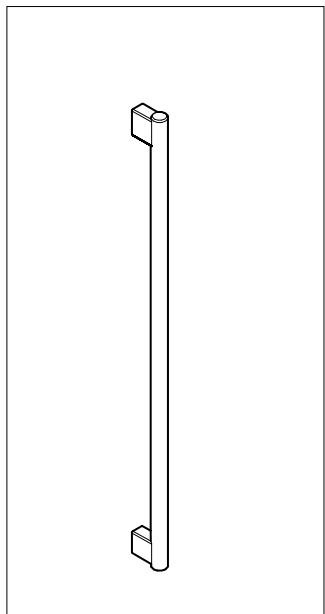

MPOMTH1_TH2

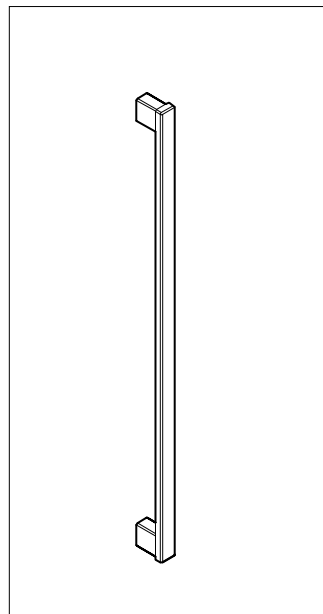

MPOMQH1_QH2

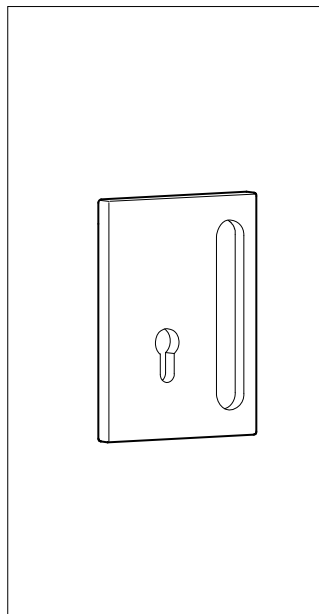

MPOM6

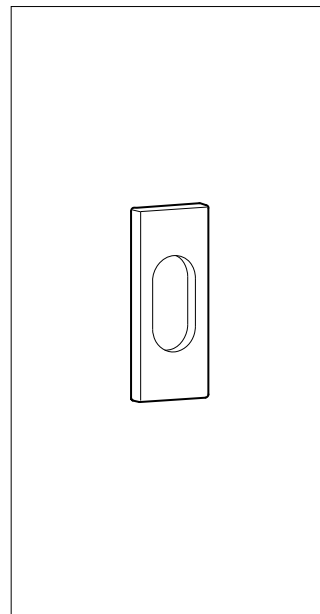

MPOM7



Porte cieche

ACCIAIO

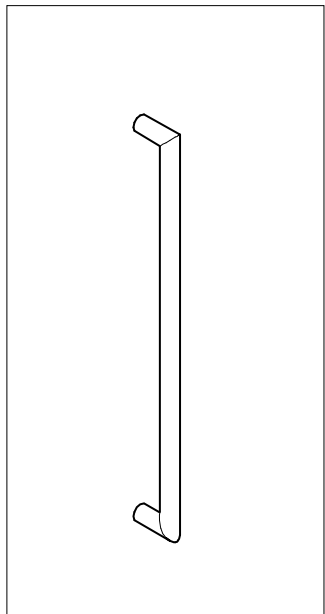

MPOMGH1_H2_H3

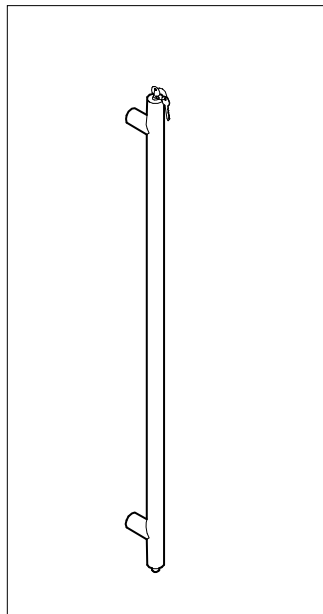

MPOM2

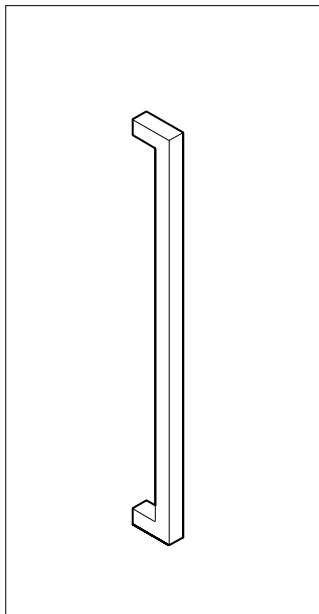

MPOMGH1Q_GH2Q_GH3Q

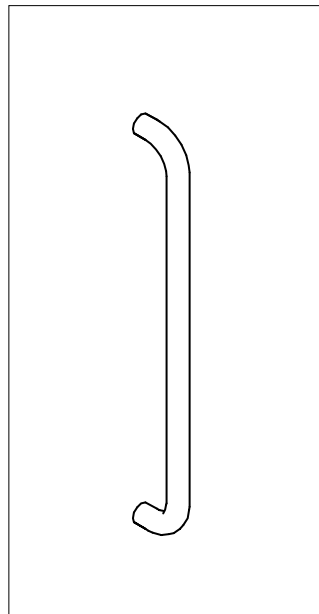

MPOM8

ALLUMINIO

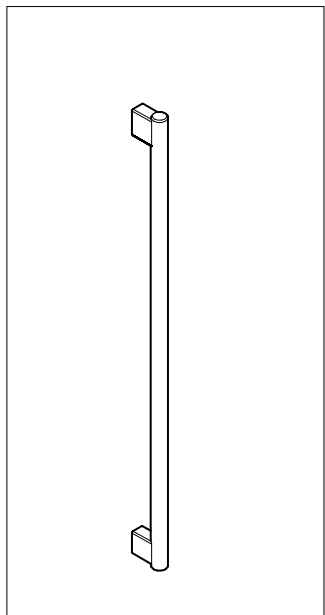

MPOMTH1_TH2

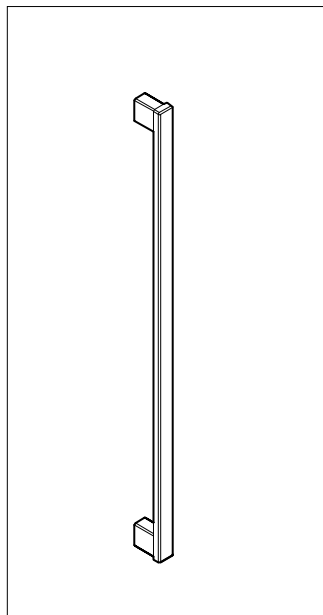

MPOMQH1_QH2

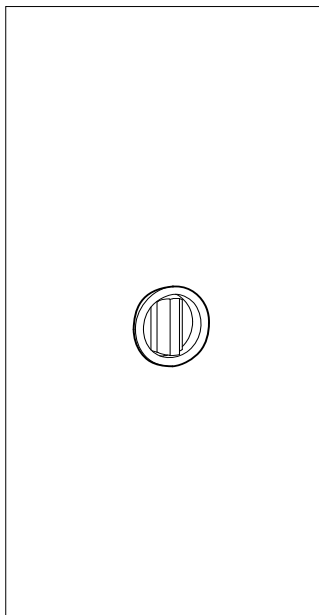

MPOM4

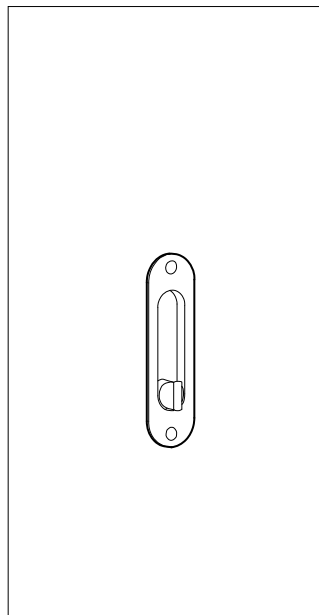

MPOM5

METRICA[®]
SENZA STRUTTURA

Accessori



Chiudiporta aerei

Chiudiporta a terra

Cerniere in alluminio

Accessori

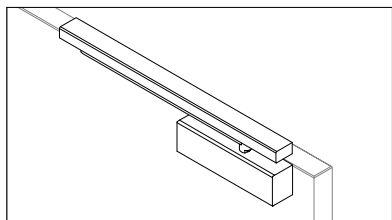

01 esterno a slitta
per anta cieca/intelaiata

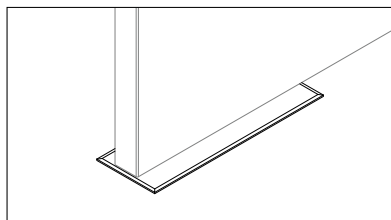

01 a pavimento
per anta cieca

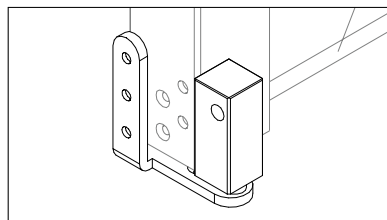

01 a bilico esterno
per anta cieca/intelaiata

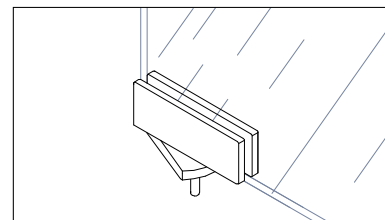

05 va e vieni velocità regolabile
per anta in vetro temperato

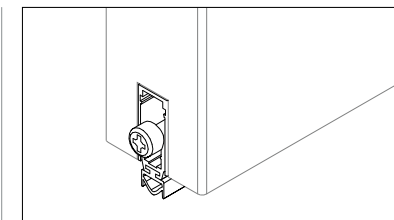

01 antispiffero insonorizzante
per anta cieca/intelaiata

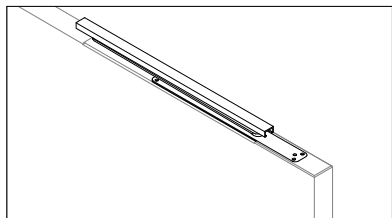

02 a scomparsa
per anta cieca/intelaiata

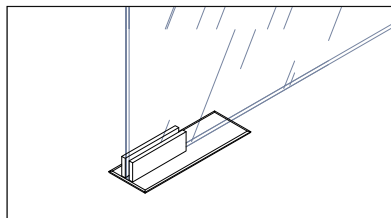

02 a pavimento
per anta in vetro temperato

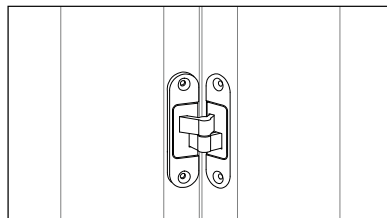

02 a scomparsa
per anta cieca/intelaiata

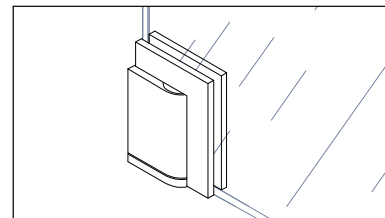

06 va e vieni velocità regolabile
per anta in vetro temperato

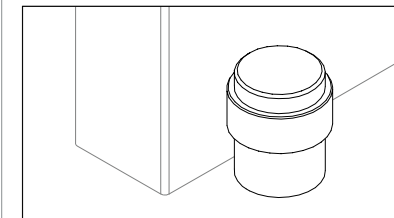

02 fermaporte
per anta cieca/intelaiata/temperato

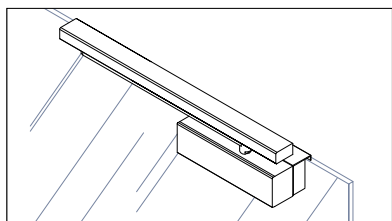

03 esterno a slitta con supporto
per anta in vetro temperato

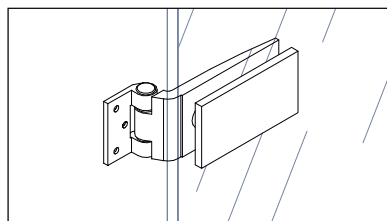

03 apertura 180°
per anta in vetro temperato

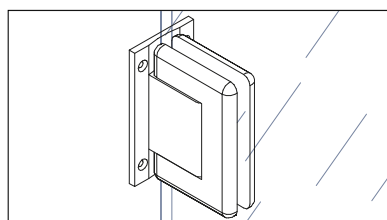

04 va e vieni velocità regolabile
per anta in vetro temperato

METRICA[®]
SENZA STRUTTURA

Finiture



Anodizzati

Finiture RAL

Lucidatura

Legni



01 Alluminio naturale



01 Bianco



01 Brillantato



01 Rovere chiaro



02 Bronzo

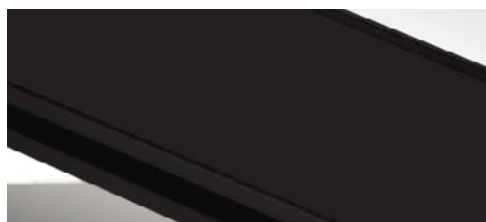

02 Nero

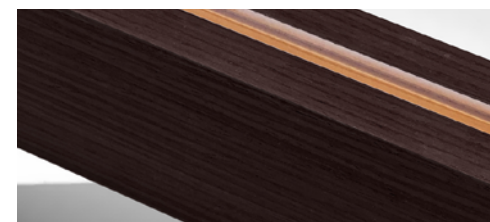

02 Rovere scuro

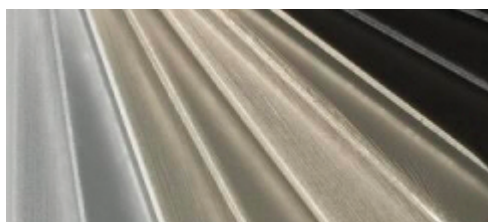

03 Colore a campione



03 Colore a campione

Pannelli ciechi



CAT. 1

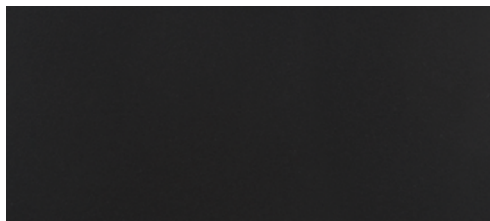

055 Nero grafite

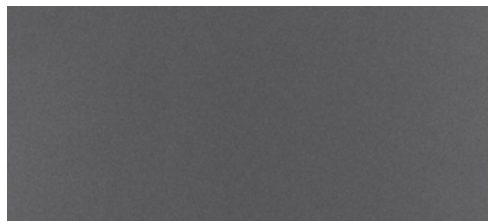

420 Piombo



418 Grigio cenere

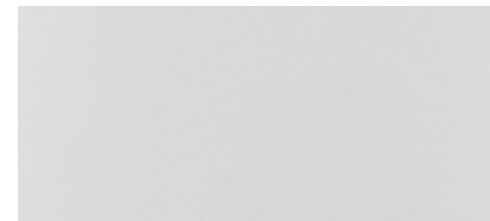

419 Grigio chiaro

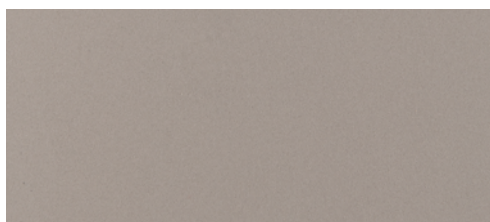

393 Tortora



417 Vaniglia

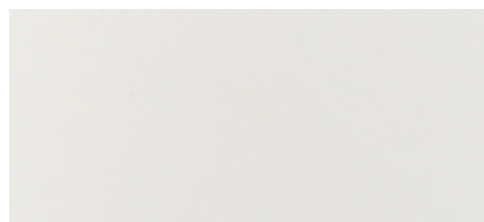

429 Bianco caldo

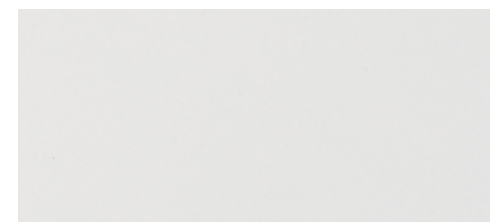

428 Bianco freddo

CAT. 2

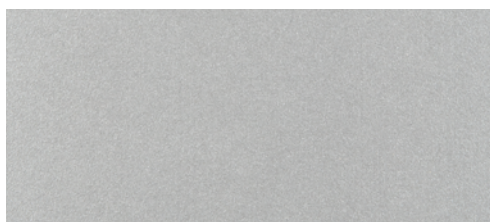

422 Argento

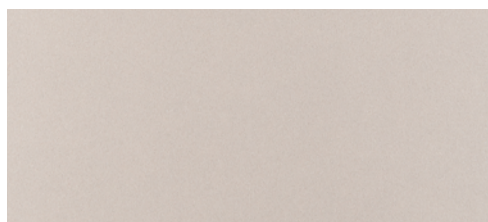

423 Champagne

Legni



CAT. 1

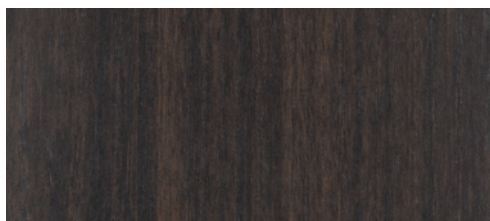

421 Eucalipto

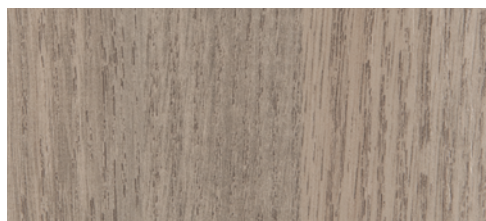

426 Rovere medio



274 Acacia



416 Bianco venato

CAT. 2

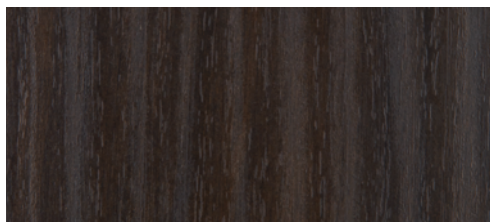

425 Noce scuro

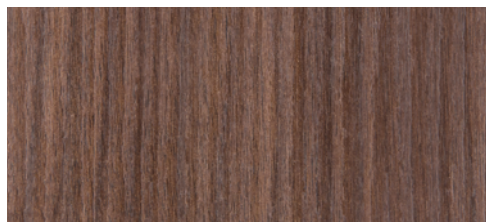

318 Noce medio

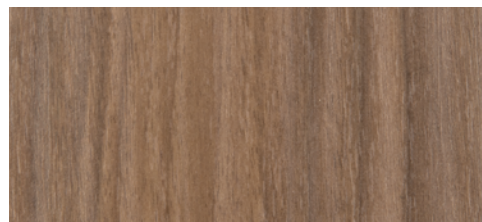

427 Noce chiaro

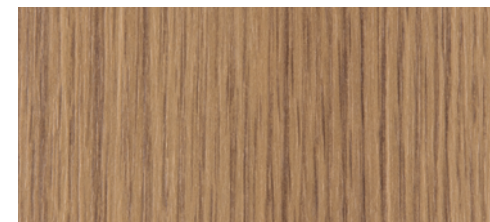

382 Rovere naturale

CAT. 3

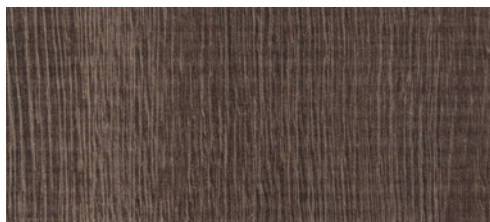

138 Rovere invecchiato - taglio seta

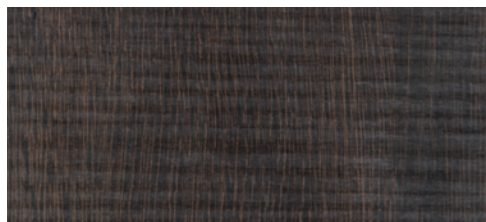

197 Eucalipto - taglio seta

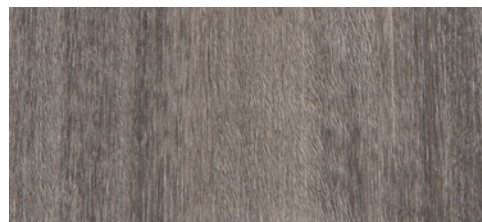

408 Rovere grigio

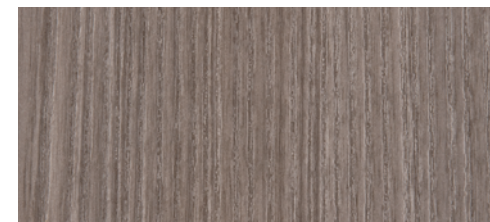

400 Rovere Danubio

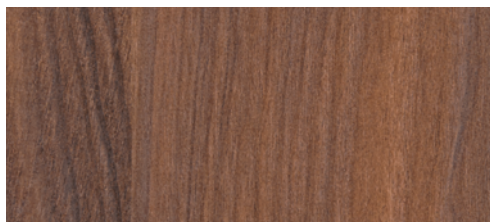

414 Noce rosso

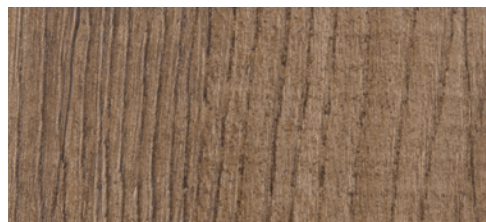

412 Rovere vintage



413 Rovere champagne



410 Rovere chiaro

Materici



CAT. 2



304 Tessuto scuro



123 Tessuto medio

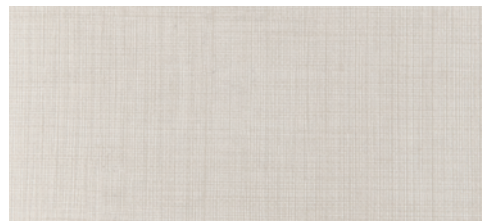

305 Tessuto chiaro



424 Ossido

CAT. 3

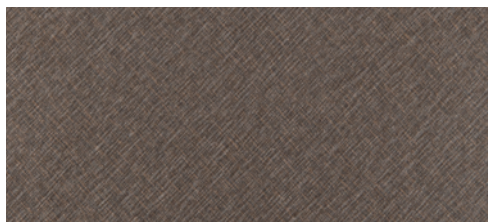

385 Lino bronzo

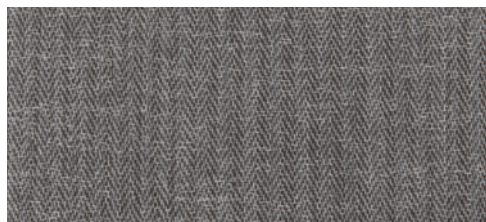

409 Corteccia

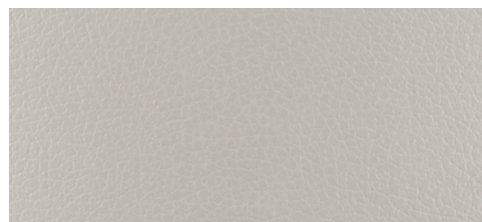

406 Primo fiore grigio

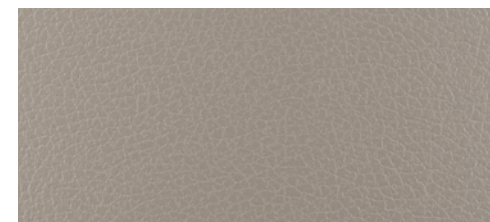

405 Primo fiore tortora



404 Primo fiore beige

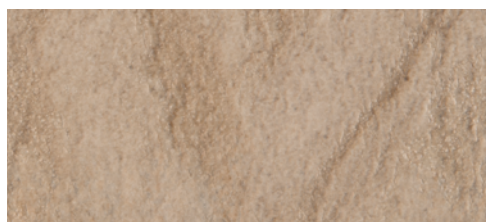

415 Deserto

Vetri



01 Trasparente



03 Satinato

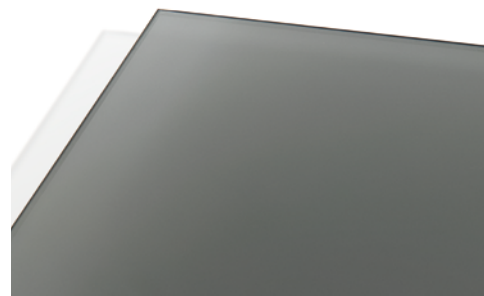

05 Fumé



02 Extrachiaro

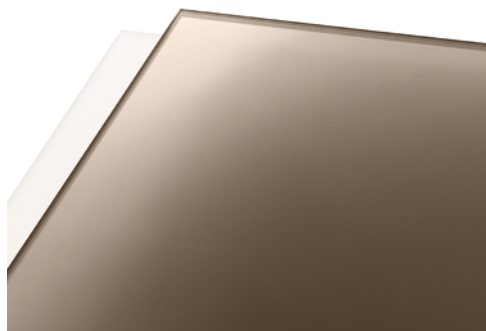

04 Bronzo



06 Verniciato a campione

METRICA[®]
SENZA STRUTTURA

Capitolato tecnico



METRICA® SENZA STRUTTURA è un sistema di pareti interne mobili attrezzate con funzione di separazione, senza struttura portante, con spessore nominale **104 mm per la metrica D** e **97 mm per la metrica F**, fornita in **sette soluzioni** formalmente diverse.

VERSIONI

METRICA® D1

Guida a sezione a T per vetro singolo centrale di spessore 55.1/55.2/66.1/66.2 o temperato 10 mm/12 mm

METRICA® D2

Guida a sezione a T per vetro doppio di spessore 55.1/55.2/66.1/66.2 o temperato 10 mm/12 mm

METRICA® SOLID

Parete composta da pannelli ciechi a base di particelle di legno di spessore 18 mm

METRICA® F1

Guida a sezione rettangolare incassata a pavimento e soffitto per vetro singolo centrale di spessore 55.1/55.2/66.1/66.2 o temperato 10 mm/12 mm

METRICA® FA

Guida a sezione rettangolare incassata a pavimento e soffitto per vetro singolo asimmetrico di spessore 55.1/55.2/66.1/66.2 o temperato 10 mm/12 mm

METRICA® F2

Guida a sezione rettangolare incassata a pavimento e soffitto per vetro doppio di spessore 55.1/55.2/66.1/66.2 o temperato 10 mm/12 mm

METRICA® F SOLID

Guida a sezione rettangolare incassata a pavimento e soffitto per doppio pannello cieco di spessore 18 mm

DESCRIZIONE GENERALE

La parete **METRICA® D**, di spessore totale 104 mm, è costituita da una struttura in **estrusi di lega di alluminio 6060 UNI 9006/1** (guide a pavimento e soffitto, montanti, partenze a muro), assemblati meccanicamente, predisposta per accogliere pannelli di chiusura in cristallo di sicurezza.

Le **guide** a pavimento e soffitto ed i profili a muro consentono la perfetta chiusura contro i paramenti murari esistenti.



I **moduli ciechi** sono forniti dalla Metrica Solid, connessi alla metrica D mediante i montanti. La corretta connessione tra i profili guida, in incroci a due o tre vie, è assicurata da raccordi angolari in alluminio, ancorati meccanicamente.

Il sistema è dotato di **profili d'angolo**, fissi e variabili, che permettono connessioni a 2/3/4 vie.

Le **connessioni lineari** tra lastre vetrate avvengono mediante guarnizioni in policarbonato e elementi ad H in alluminio.

La parete **METRICA® F**, di spessore 97 mm, è costituita da una struttura in **estrusi di lega di alluminio 6060 UNI 9006/1 da incasso** (guide a pavimento e soffitto, montanti, partenze a muro), assemblati meccanicamente, predisposta per accogliere pannelli di chiusura in cristallo di sicurezza.

Le **guide** a pavimento e soffitto ed i profili a muro sono ottenuti dall'assemblaggio della stessa matrice con diversi profili di chiusura della cave per il vetro: le tre configurazioni possibili si ottengono da un montaggio facilitato.

I **profili** consentono la perfetta chiusura contro i paramenti murari esistenti sia con la soluzione incassata che a vista.

La parete metrica F è dotata di **profili d'angolo** fissi che permettono connessioni a 2/3/4 vie. Le connessioni lineari tra lastre vetrate avvengono mediante guarnizioni in policarbonato e elementi ad H in alluminio.

Le operazioni di livellamento verticali sono assicurate da due piedini di regolazione, posti a livello del pavimento e del soffitto nella metrica F, o mediante spessori micrometrici da vetro nella metrica D.

I **moduli ciechi** sono ottenuti con pannelli nobilitati da 18 mm fresati perimetralmente per consentire l'inserimento negli stessi profili predisposti per i tamponamenti in cristallo.

Le **porte**, disponibili nella tipologia a battente o scorrevole esterna e interna, possono essere fornite sia ad altezza standard sia ad altezza di parete. Entrambe le tipologie sono previste ad anta singola e doppia.

Il **tipo a battente** può avere l'anta in legno, in vetro intelaiato singolo e doppio, e solo in vetro; La versione intelaiata permette l'alloggiamento di chiudiporta superiori ad incasso e ghigliottine acustiche inferiori; quella vetrata permette unicamente l'installazione del chiudiporta esterno.

Il **tipo scorrevole** con guida esterna o è realizzabile in legno, in vetro intelaiato singolo o solo vetro filo lucido; con guida incassata all'interno della



struttura della parete, è realizzabile solo in legno o vetro filo lucido. Nel caso della metrica F la porta scorrevole interna può essere in vetro intelaiato. Il corretto scorrimento è garantito da carrelli con ammortizzatore di chiusura ed apertura delle ante.

L'**anta in legno tamburato**, spessore 43 mm, è realizzata con struttura interna a nido d'ape inserita in un telaio perimetrale in legno di abete e pannelli fibrolegnosi sui due lati e rifinita con laminato HPL bordato in ABS, sp=10/10 mm.

L'**anta in vetro intelaiata**, perimetralmente presenta profili estrusi in lega di alluminio 6060 UNI 9006/1, di larghezza differenziata, e lastra interna in vetro temperato o stratificato (3+3 mm), con finitura trasparente o acidata.

Nelle **ante in legno o con vetro intelaiato**, le cerniere previste sono: esterne a bilico, con apertura a 180°; a scomparsa nel telaio, regolabili su tre assi, con apertura a 180°.

L'**anta in vetro** è costituita da una lastra temperata, con finitura trasparente o acidata, di spessore 10 mm.

Le cerniere previste nelle ante filo lucido sono: pressofuse in alluminio con apertura a 110° o 180°; a bilico, in alluminio e acciaio, con apertura a 180°; lineari, in alluminio e acciaio, con apertura a 180°.

Gli **stipiti** delle porte ed i montanti della metrica D, realizzati in profili estrusi di alluminio a “cannocchiale” e dotati di guarnizioni di battuta in PVC, in colore grigio RAL 9006, permettono l'alloggiamento di eventuali cavi elettrici e l'inserimento di punti di comando a frutto singolo.

In corrispondenza del punto di battuta della serratura, sono previste controbordi in acciaio incassati nel telaio di alluminio, che garantiscono precisione di chiusura dello scrocco ed estrema robustezza.

Nei telai porta esclusivi della Metrica F per ragioni dimensionali e di resistenza non è possibile inserire punti interruttore e prese elettriche; l'adeguato **cablaggio** della parete è comunque possibile attraverso un **modulo cieco**, studiato per favorire l'installazione di punti luce, punti presa, termostati, sensori di allarmi ed altre apparecchiature dimensionalmente compatibili.

Le porte sono dotate di una ricca **gamma di maniglie** di serie che può essere ulteriormente incrementata grazie all'impiego di serrature con piastra universale adatte anche all'installazione di articoli fuori catalogo.

La parete è perfettamente **integrabile** con la versione a contenitore Quadra.



01. Modulo intero in legno con isolante interno solo nelle fasce di compensazione - lana di vetro d=35 Kg/mc Sp.=60 mm
- Prova Acustica -

Certificato n. 248482 IT/EN - UNI EN ISO 140-3:2006 ed UNI EN ISO 717-1:2007

02. Modulo intero in legno con isolante interno in lana di vetro d=35 Kg/mc Sp.=60 mm ed echostop -
Prova Acustica -

Certificato n. 248483 IT/EN - UNI EN ISO 140-3:2006 ed UNI EN ISO 717-1:2007

03. Modulo a fasce in legno con isolante interno solo nelle fasce di compensazione - lana di vetro d=35 Kg/mc Sp.=60 mm
- Prova Acustica -

Certificato n. 248488 IT/EN - UNI EN ISO 140-3:2006 ed UNI EN ISO 717-1:2007

04. Modulo a fasce in legno con isolante interno in lana di vetro d=35 Kg/mc Sp.=60 mm e profilo coestruso - Prova
Acustica -

Certificato n. 248489 IT/EN - UNI EN ISO 140-3:2006 ed UNI EN ISO 717-1:2007

05. Modulo intero ed echostop - Prova Acustica -

Certificato n. 248484 IT/EN - UNI EN ISO 140-3:2006 ed UNI EN ISO 717-1:2007



01. Modulo intero con due lastre in vetro stratificato 5+5 - Prova Acustica -
Certificato n. 279357 IT/EN - UNI EN ISO 140-3:2006 ed UNI EN ISO 717-1:2007

02. Modulo intero con due lastre in vetro stratificato 5+5 e 6+6 acustico - Prova Acustica -
Certificato n. 279358 IT/EN - UNI EN ISO 140-3:2006 ed UNI EN ISO 717-1:2007

03. Modulo intero con due lastre in vetro stratificato 6+6 - Prova Acustica -
Certificato n. 279360 IT/EN - UNI EN ISO 140-3:2006 ed UNI EN ISO 717-1:2007

04. 3 moduli vetrati verticali in vetro stratificato 12/13 mm - Prova Meccanica -
Certificato n. 273436 IT/EN - UNI 8201:1982; UNI EN 947:2000; UNI EN 948:2000; UNI EN 949:2000; UNI EN 950:2000



METRICA PORTE

01. Porta in legno - Prova Acustica -
Certificato n. 251626 IT/EN - UNI EN ISO 140-3:2006 ed UNI EN ISO 717-1:2007

02. Porta in vetro temperato 10 mm - Prova Acustica -
Certificato n. 251625 IT/EN - UNI EN ISO 140-3:2006 ed UNI EN ISO 717-1:2007

03. Porta in vetro stratificato 6/7 intelaiato - Prova Acustica -
Certificato n. 251624 IT/EN - UNI EN ISO 140-3:2006 ed UNI EN ISO 717-1:2007

METRICA D: PORTA CIECA

01. Porta cieca 104 mm. - Prova Acustica -
Certificato n. 279745 IT/EN - UNI EN ISO 140-3:2006 ed UNI EN ISO 717-1:2007

METRICA D: PORTA VETRATA

01. Porta vetrata 104 mm. - Prova Acustica -
Certificato n. 279746 IT/EN - UNI EN ISO 140-3:2006 ed UNI EN ISO 717-1:2007



Etoile s.r.l. - Società Unipersonale

Via D. Albertario, 50 61032 Zona Ind.le Bellocchi - Fano (PU) Italy

P. +39.0721.85.59.34 - F. +39.0721.85.92.14

info@etoilesrl.it - www.etoilesrl.it