



☐ ETOILE

**METRICA® V**

---





- 01.** Spessore 104 mm
- 02.** Struttura portante in lamiera zincata UNI EN 10143
- 03.** Parete a pannelli verticali e fasce orizzontali
- 04.** Pannelli a passo 500/1000/1500/2000 mm
- 05.** Doppio vetro intelaiato - spessore 33.1 o 5 mm
- 06.** Profili d'angolo fissi e variabili - connessioni 2/3/4 vie
- 07.** Telaio porta cablabile
- 08.** Modulo tecnico ispezionabile
- 09.** 11 versioni di porte battenti - cieche, in vetro temperato e intelaiate
- 10.** 5 versioni di porte scorrevoli esterne - cieche, in vetro temperato e intelaiate

- 01.** Doppio vetro verticale 33.1 - **42 dB**
- 02.** Doppio vetro orizzontale 33.1 - **40 dB**
- 03.** Doppio vetro verticale 33.1 + pannello cieco da **40 dB** a **46 dB**





# Partenze

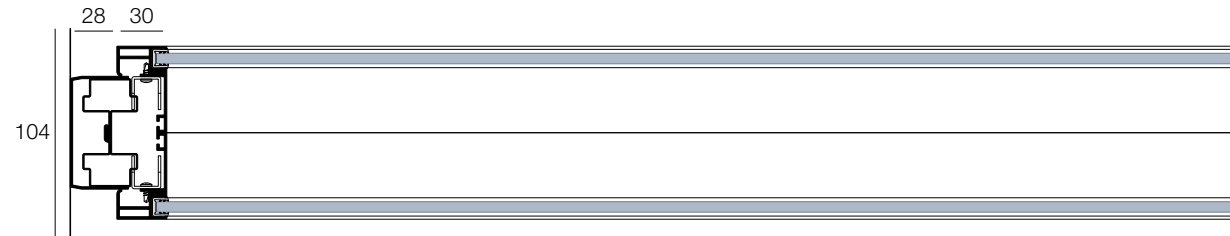
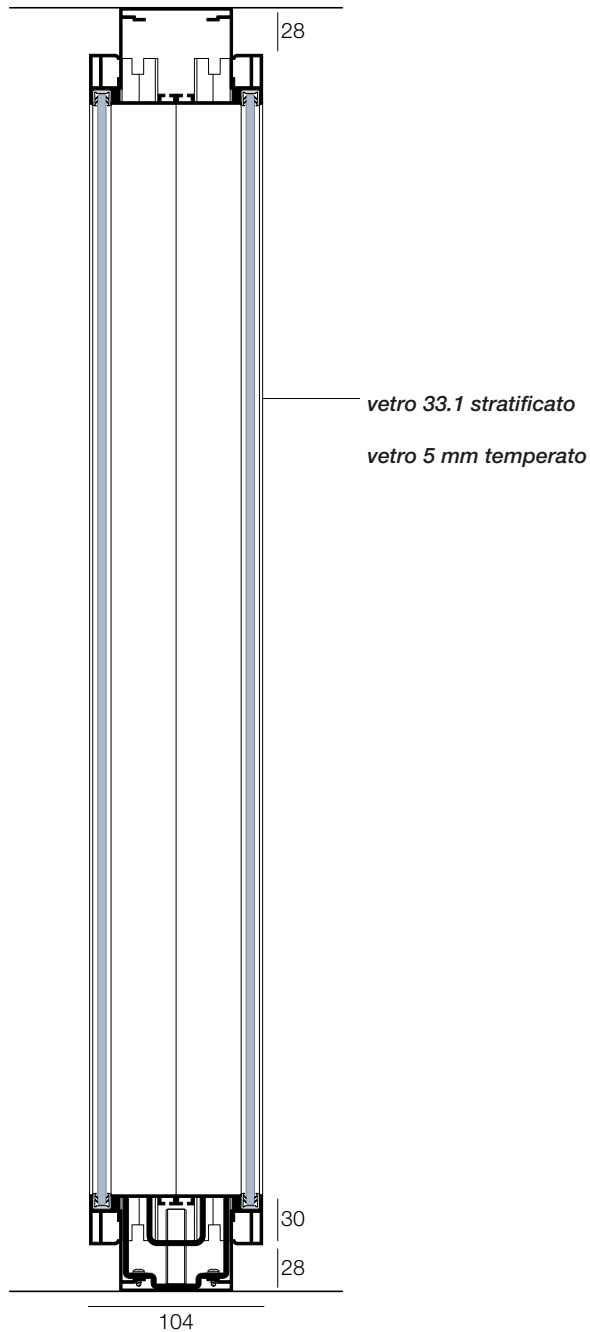

**Partenza telescopica**

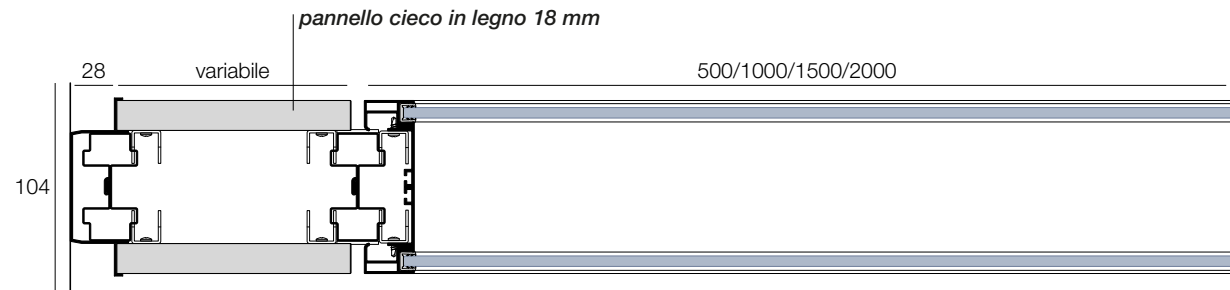

**Partenza da tamponamento**

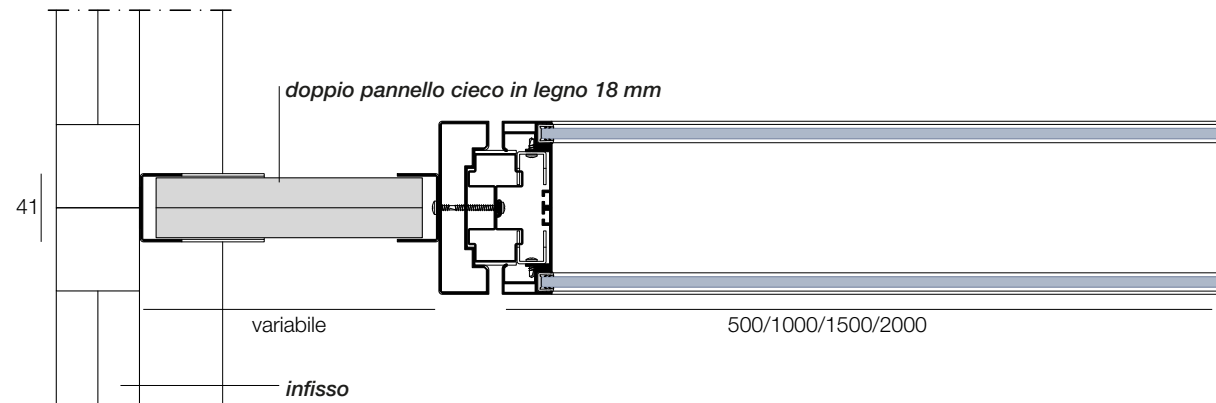

**Partenza da parete**

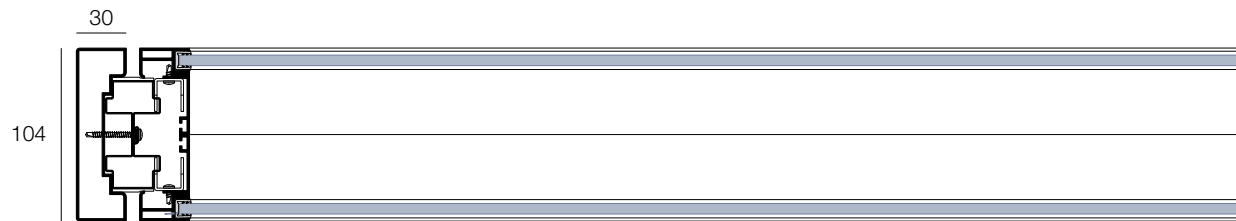

**Profilo terminale**

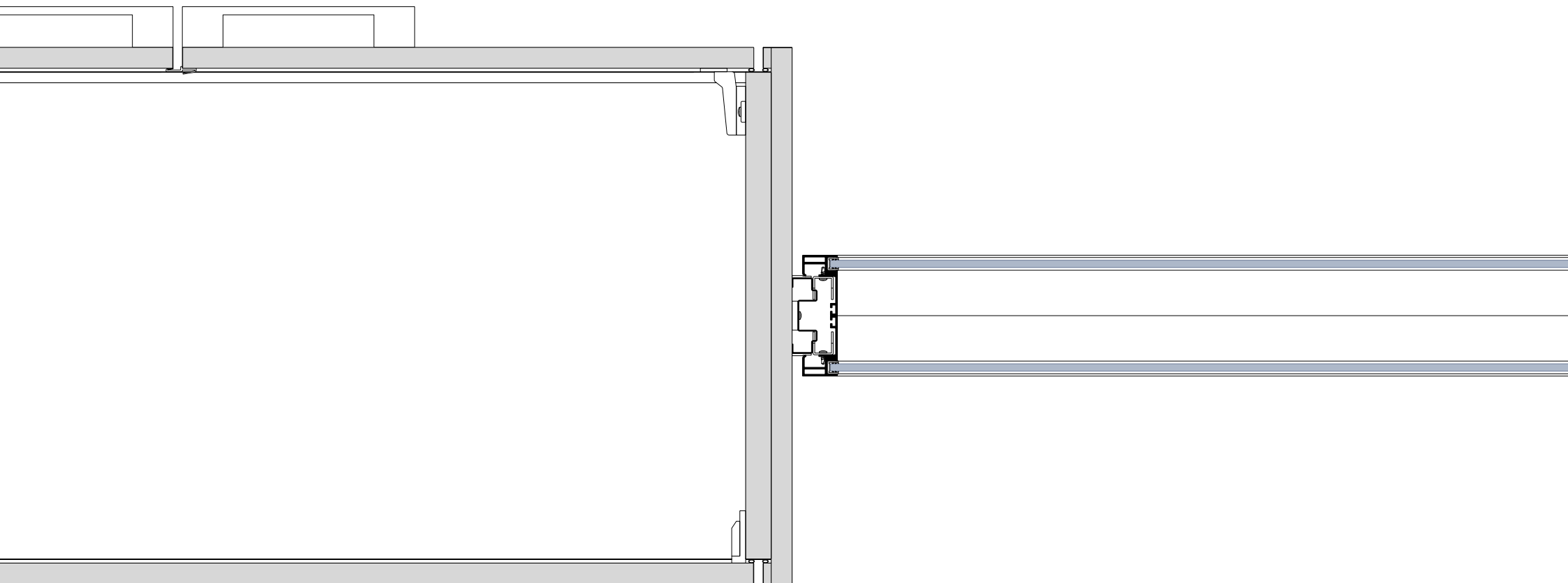

**Partenza da contenitore**

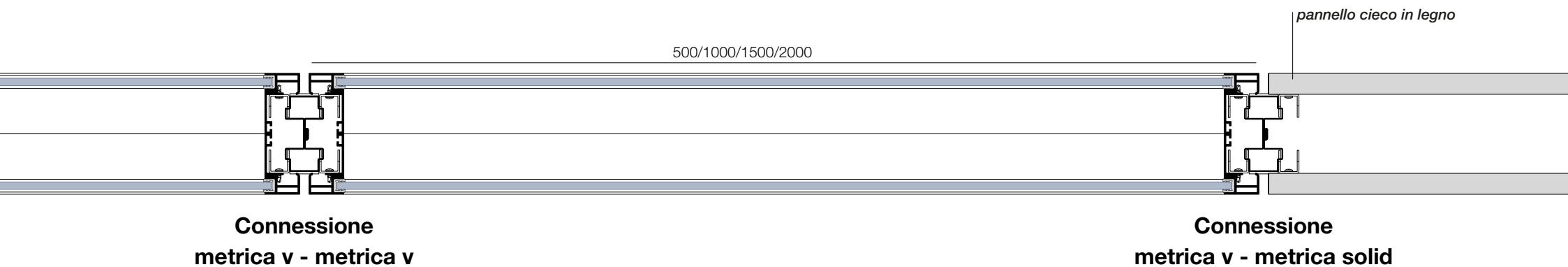

# Angoli

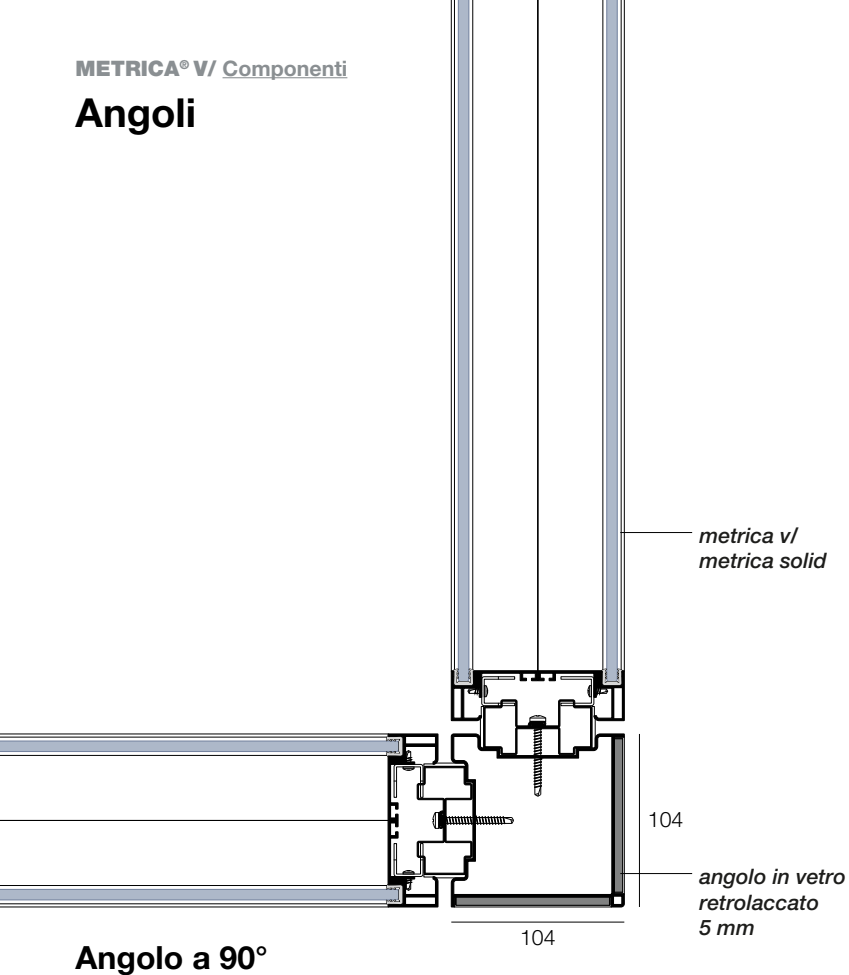

Angolo a 90°

Angolo 2 vie

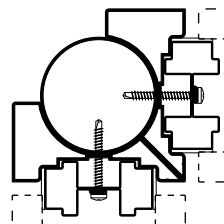

Angolo variabile

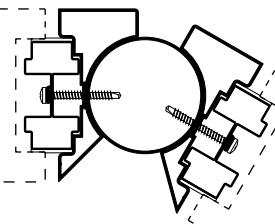

Angolo 3 vie

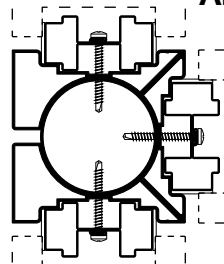

Angolo 4 vie

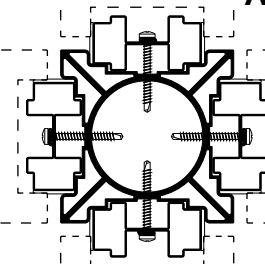

# Cablaggio e modulo tecnico della porta a battente



## Modulo tecnico

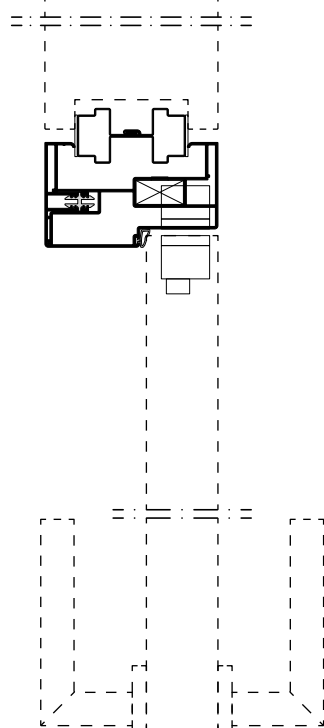
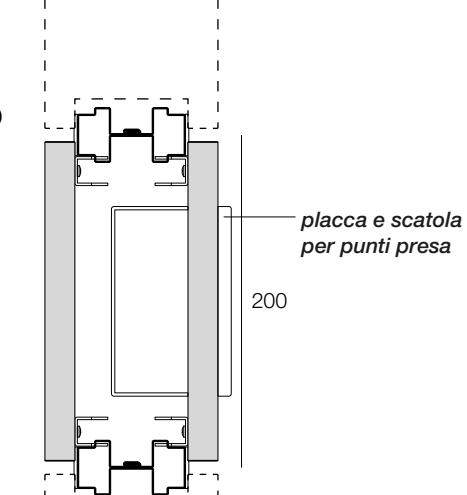

## Soluzione di cablaggio

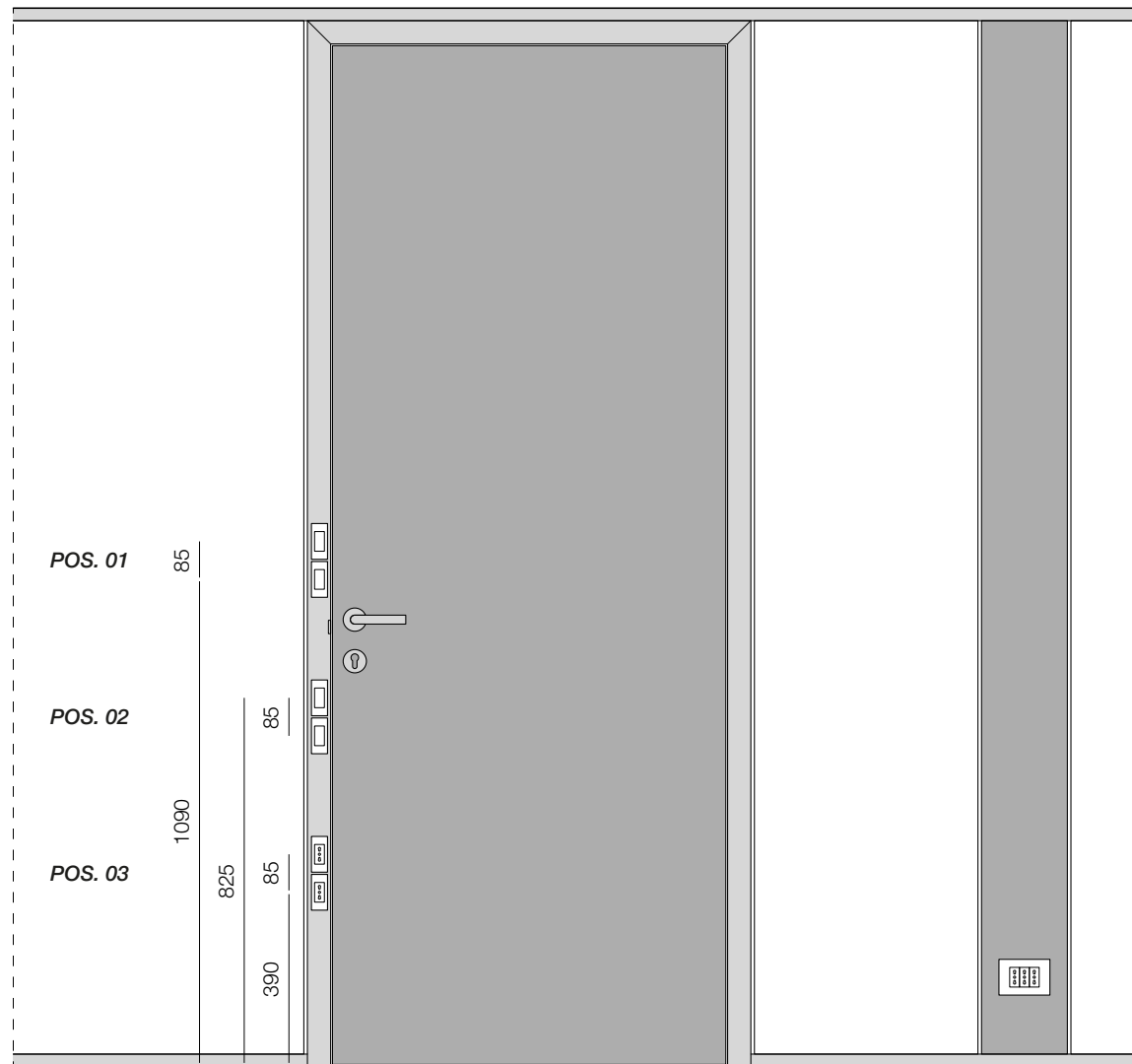
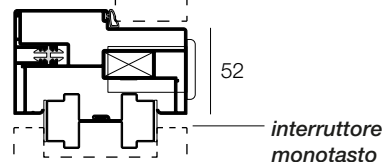

\*posizioni possibili di interruttori e prese su telaio porta

# Modulo tecnico della porta scorrevole



## Modulo tecnico

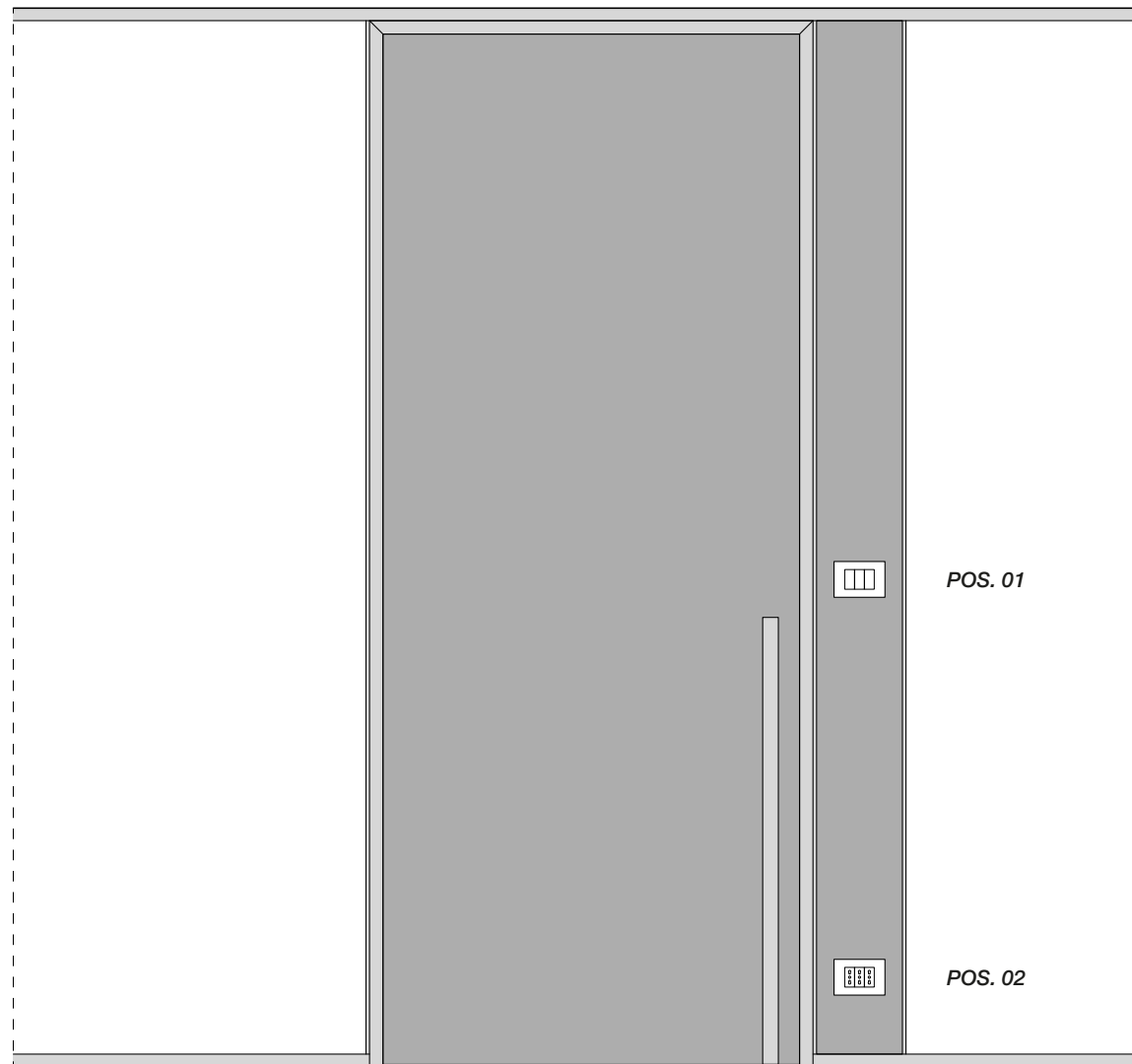
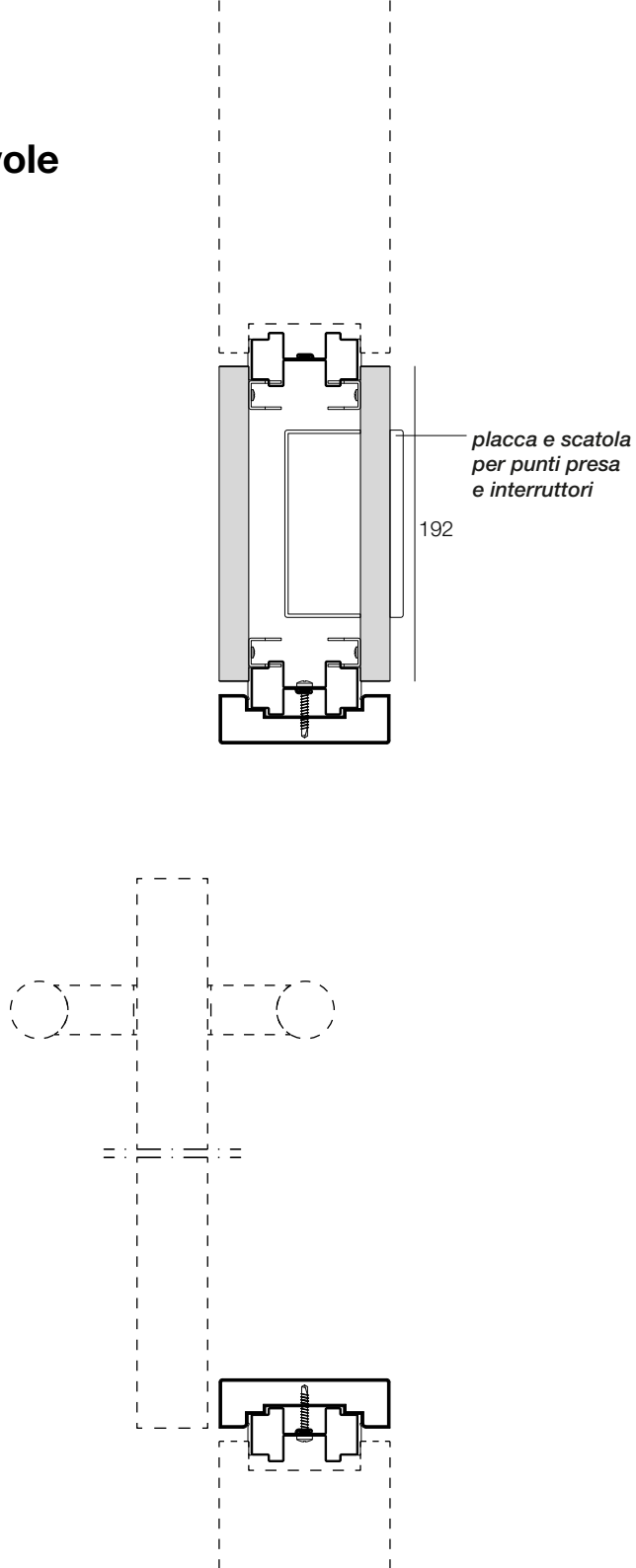

\*posizioni possibili di interruttori e prese su modulo tecnico

**METRICA**<sup>®</sup>  
STRUTTURALE

Porte e maniglie

---



# TELAI PORTE BATTENTI



Telaio porta su **Metrica R**

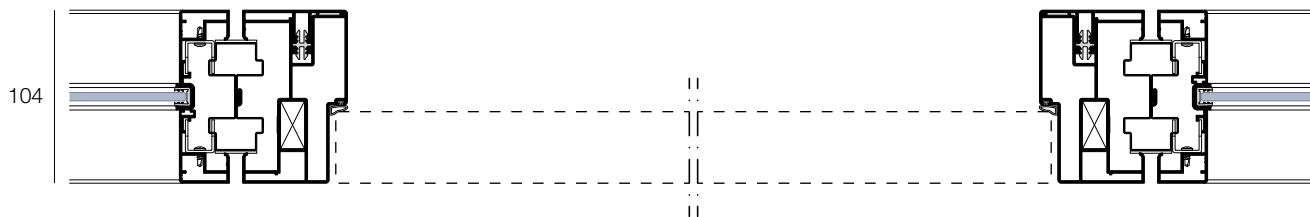

Telaio porta su **Metrica V**

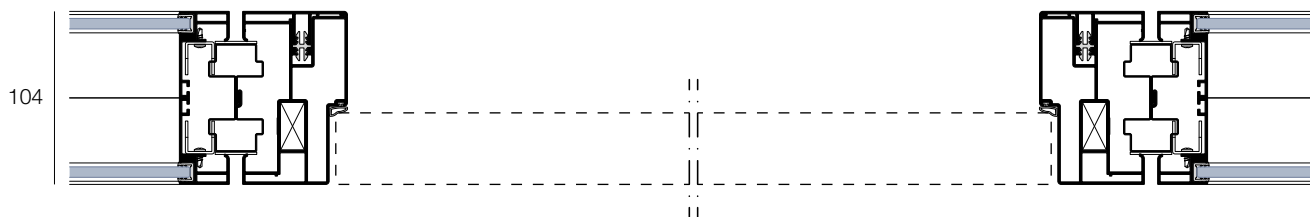

Telaio porta su **Metrica S**

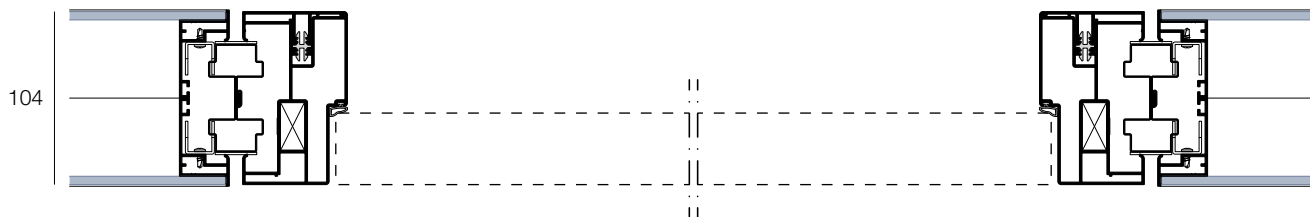

Telaio porta su **Metrica Solid**

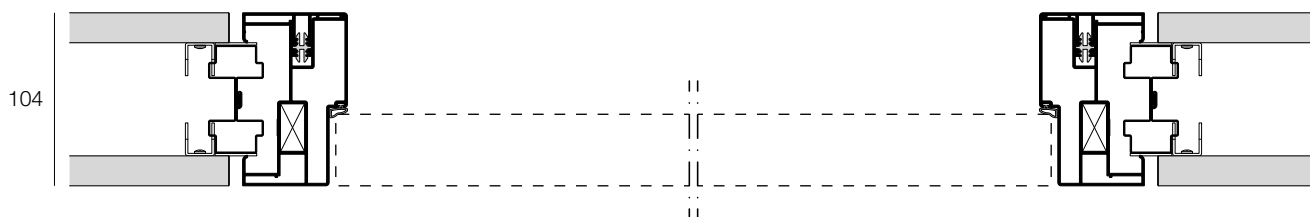

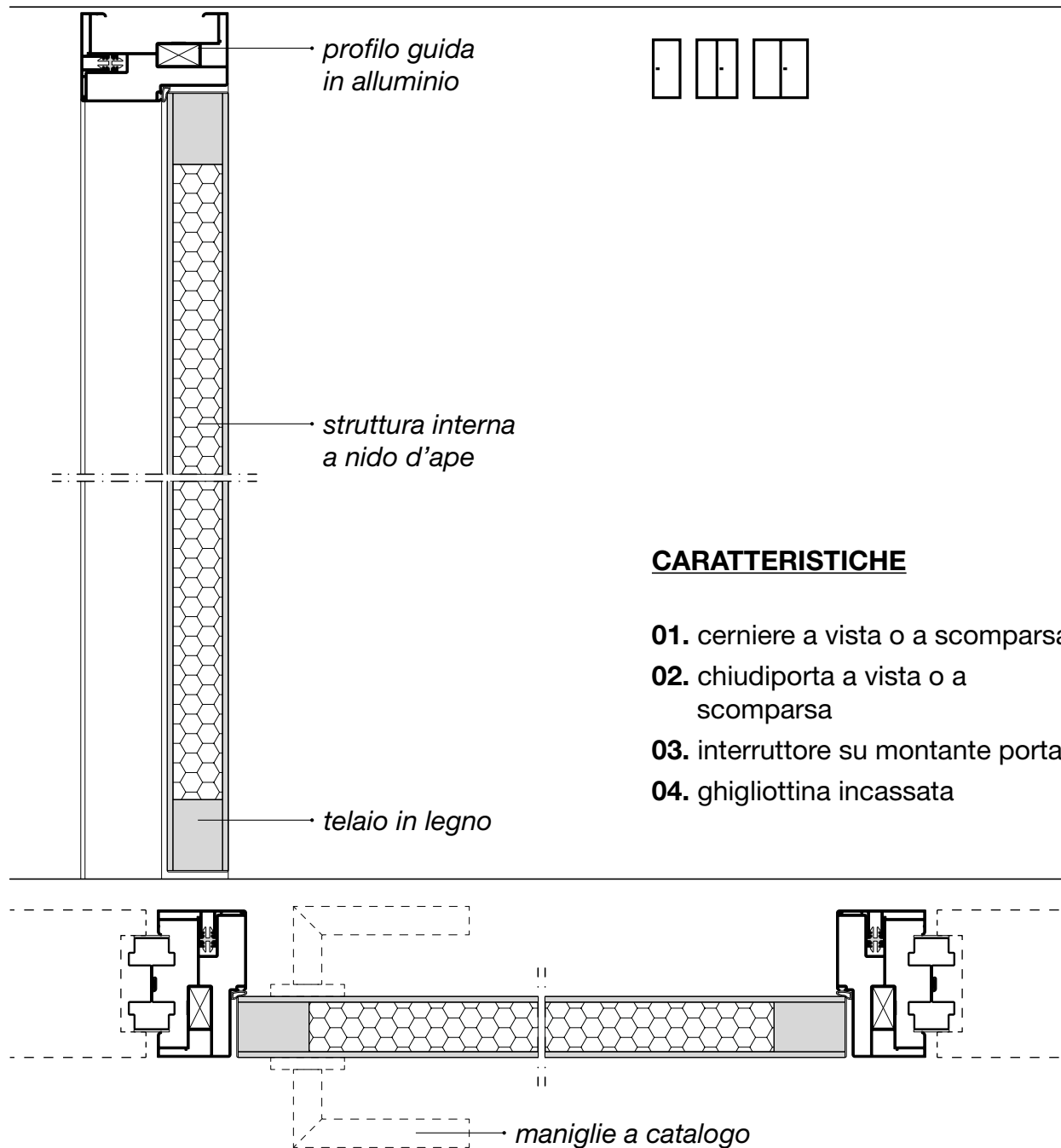

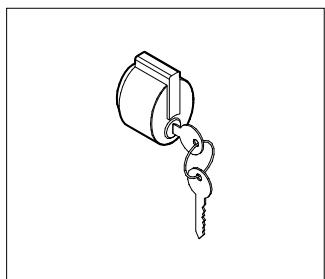

**ML1**

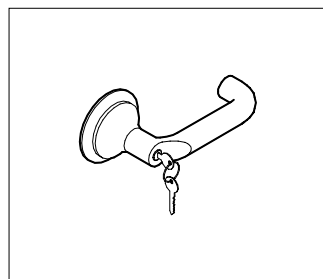

**ML4**

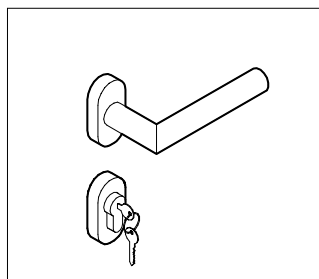

**ML5**

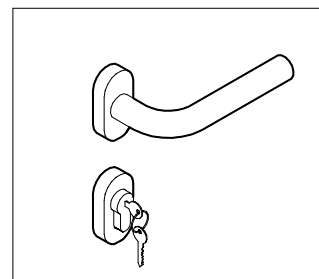

**ML6**

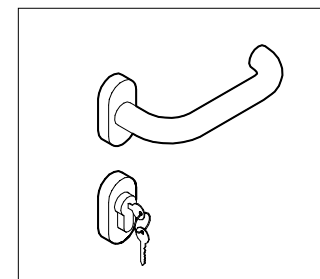

**ML7**

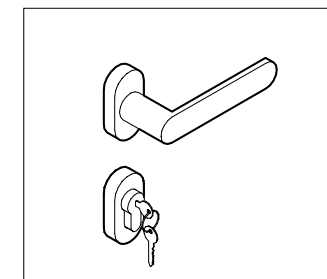

**ML8**

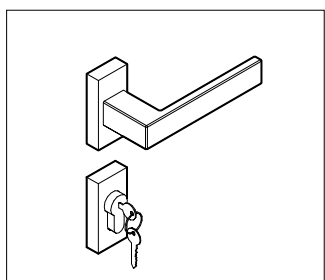

**ML9**

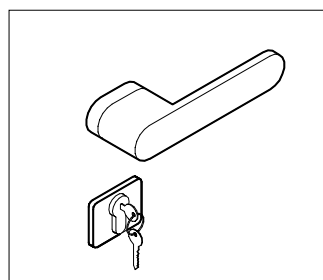

**ML10**

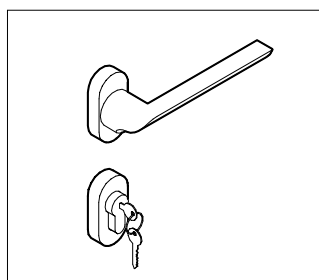

**ML11**

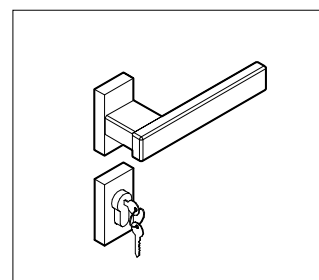

**MLQ**

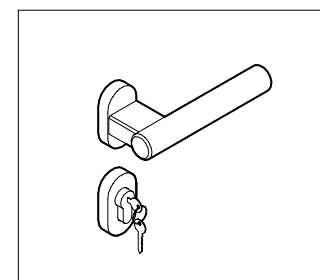

**MLT**

# ANTA VETRO TEMPERATO\_CERNIERE A VISTA sp. 10 mm

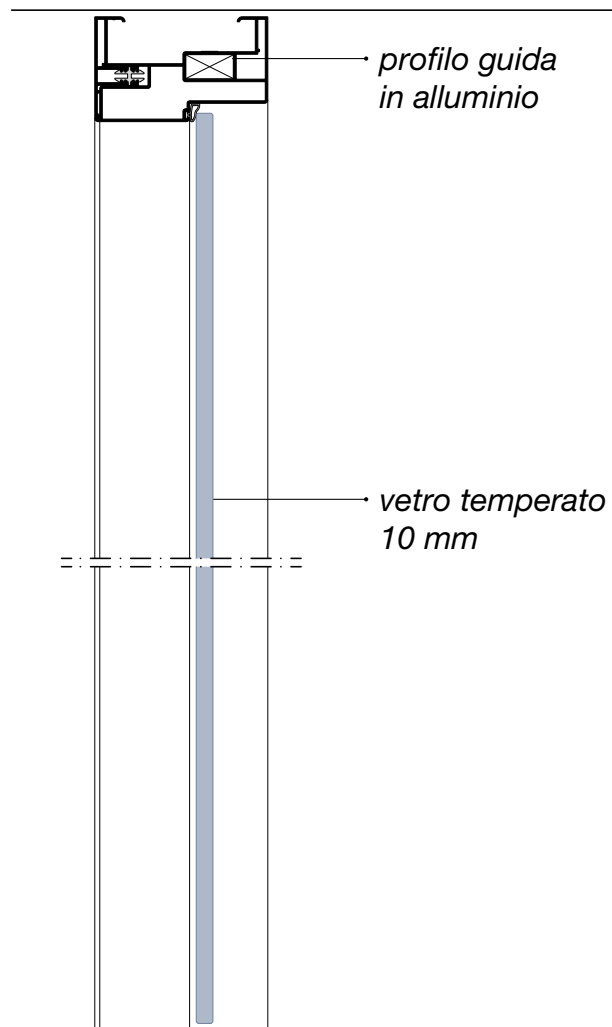
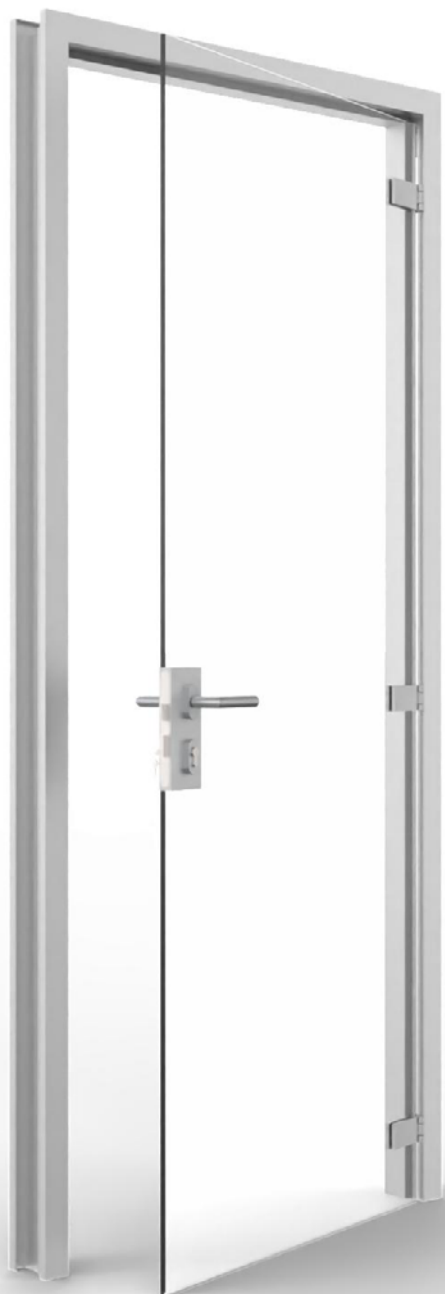

## CARATTERISTICHE

- 01. cerniere a vista - 110° o 180°
- 02. chiudiporta a vista
- 03. maniglia con adattatore per vetro
- 04. interruttore su montante porta
- 05. ghigliottina esterna

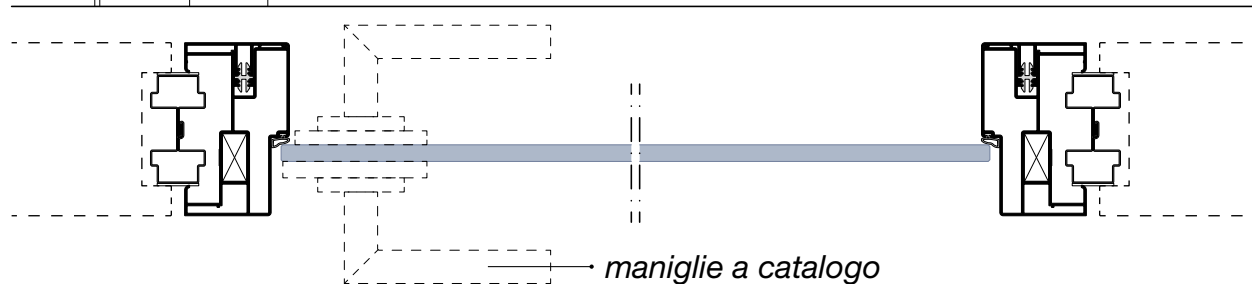

# ANTA VETRO TEMPERATO\_CERNIERE A VISTA sp. 10 mm

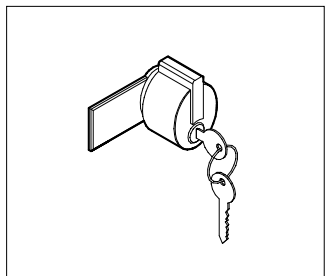

MC1

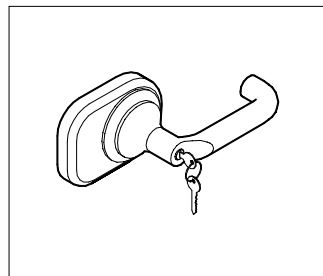

MC4

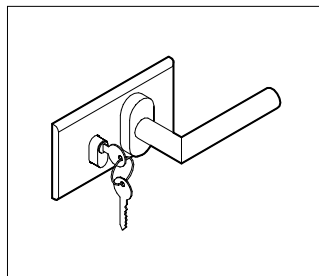

MC5

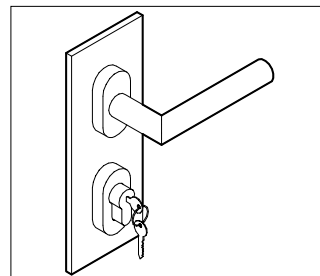

MC5V

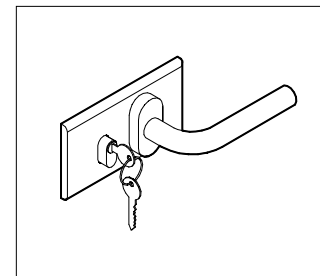

MC6

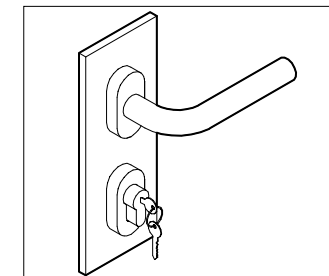

MC6V

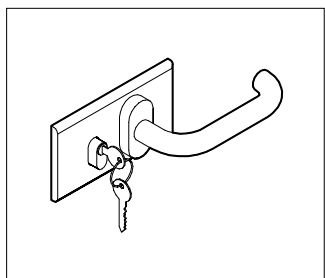

MC7

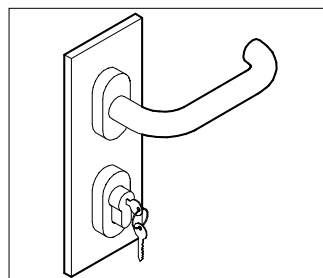

MC7V

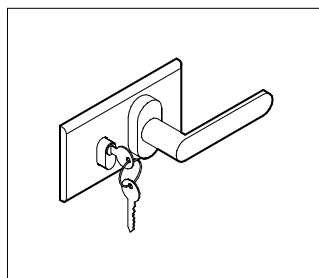

MC8

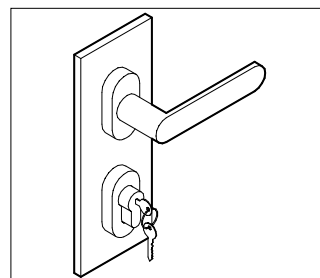

MC8V

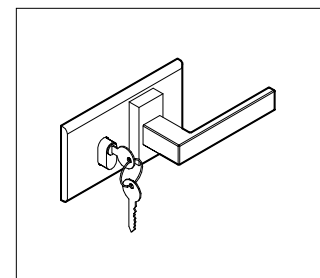

MC9

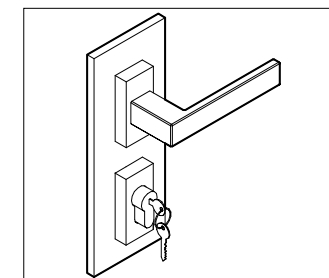

MC9V

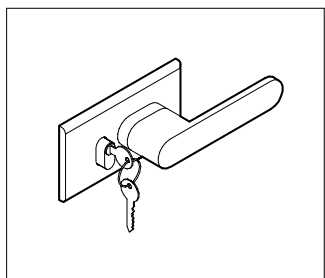

MC10

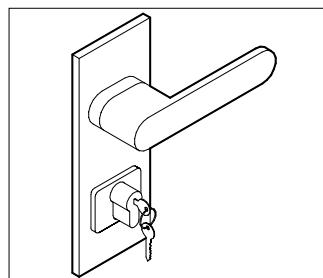

MC10V

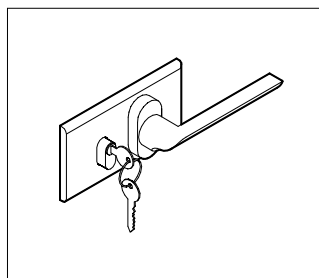

MC11

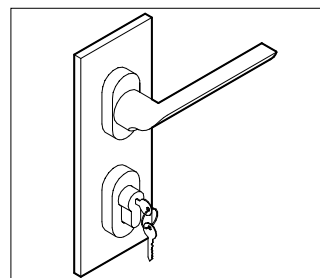

MC11V

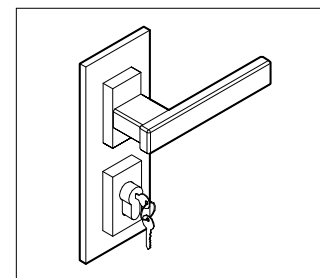

MCQ

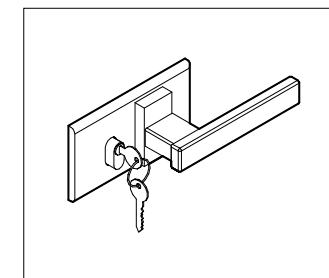

MCQO

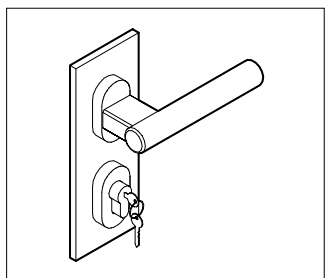

MCT

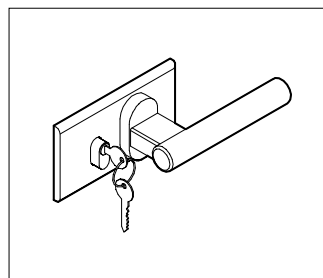

MCTO

# ANTA VETRO TEMPERATO\_CERNIERA CONTINUA sp. 10 mm

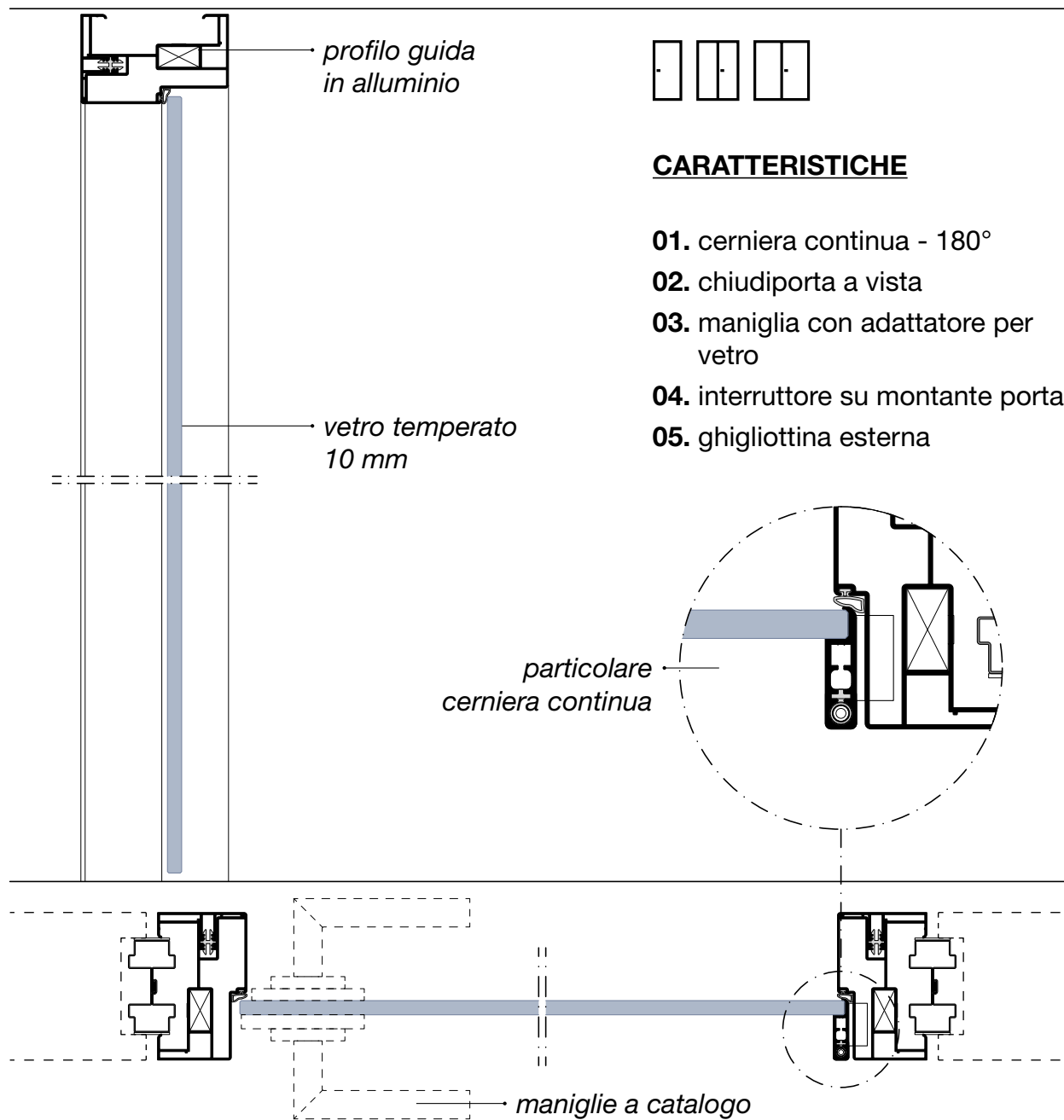
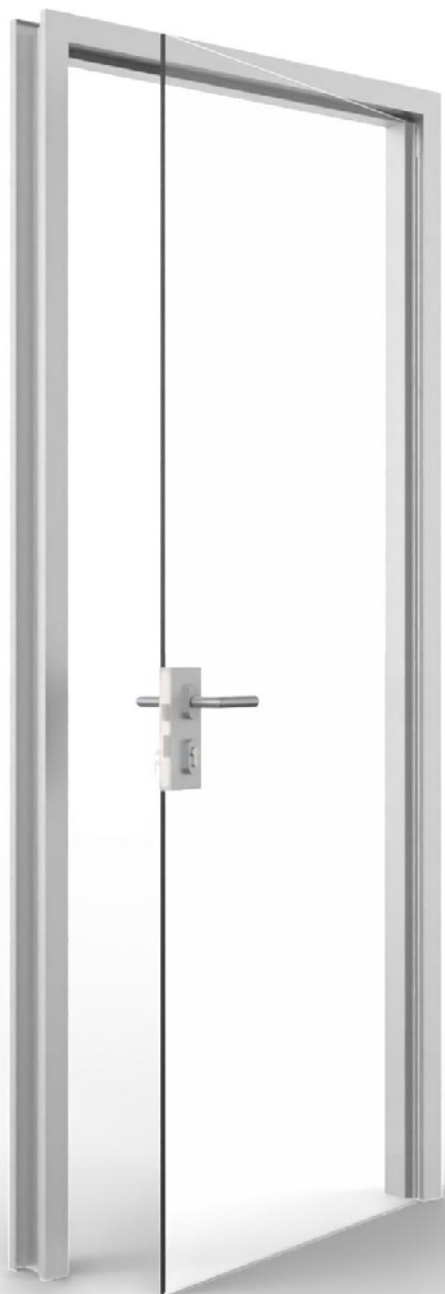

# ANTA VETRO TEMPERATO\_CERNIERA CONTINUA sp. 10 mm

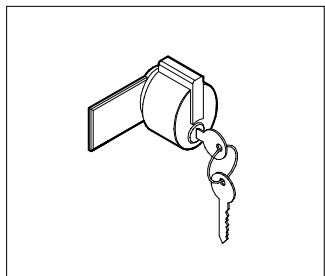

MC1

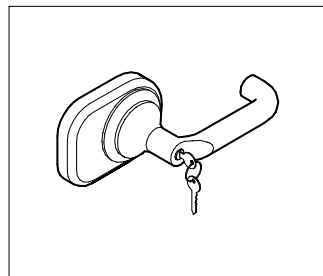

MC4

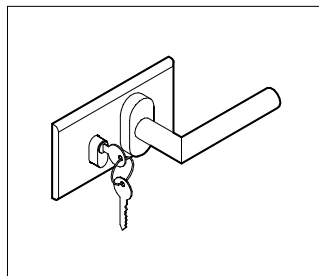

MC5

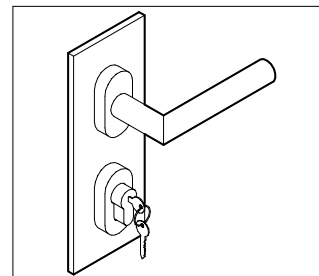

MC5V

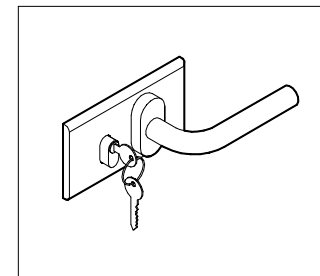

MC6

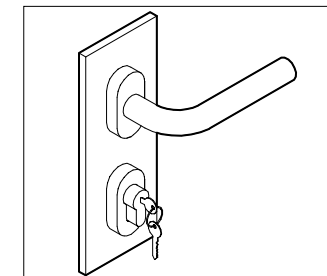

MC6V

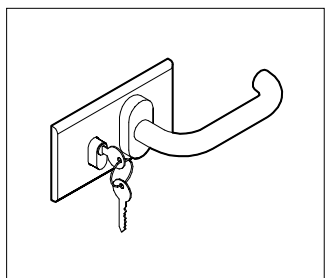

MC7

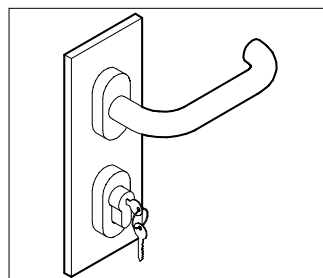

MC7V

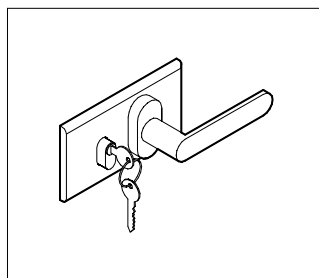

MC8

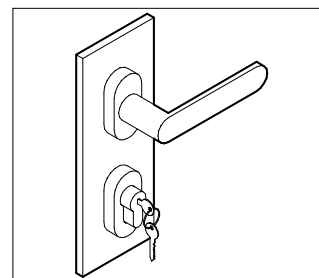

MC8V

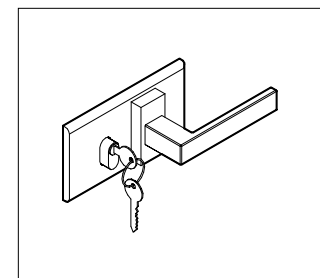

MC9

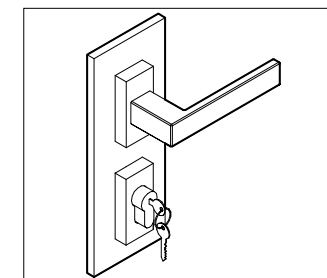

MC9V

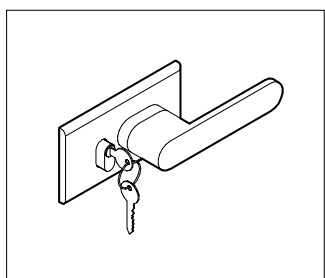

MC10

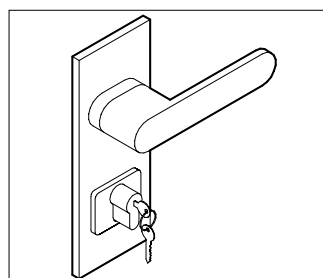

MC10V

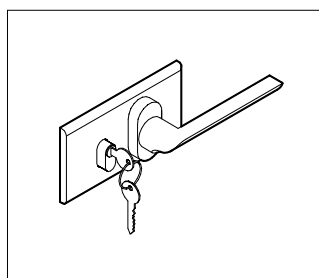

MC11

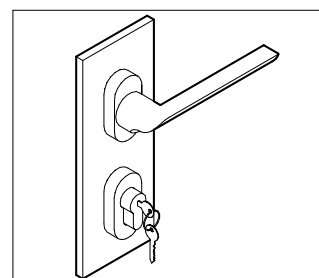

MC11V

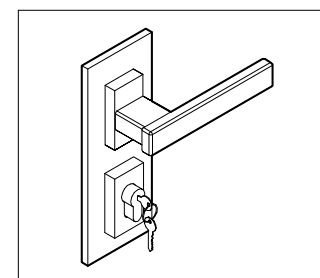

MCQ

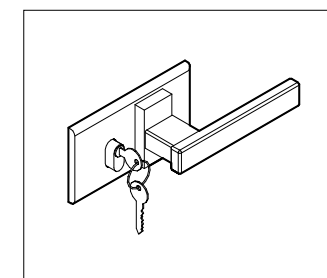

MCQO

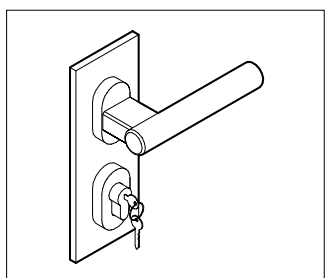

MCT

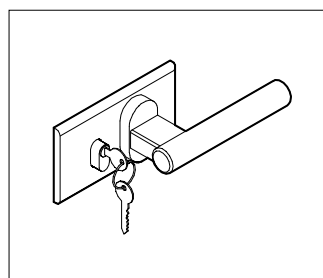

MCTO

# ANTA INTELAIATA GRANDE CON PANNELLO sp. 43 mm

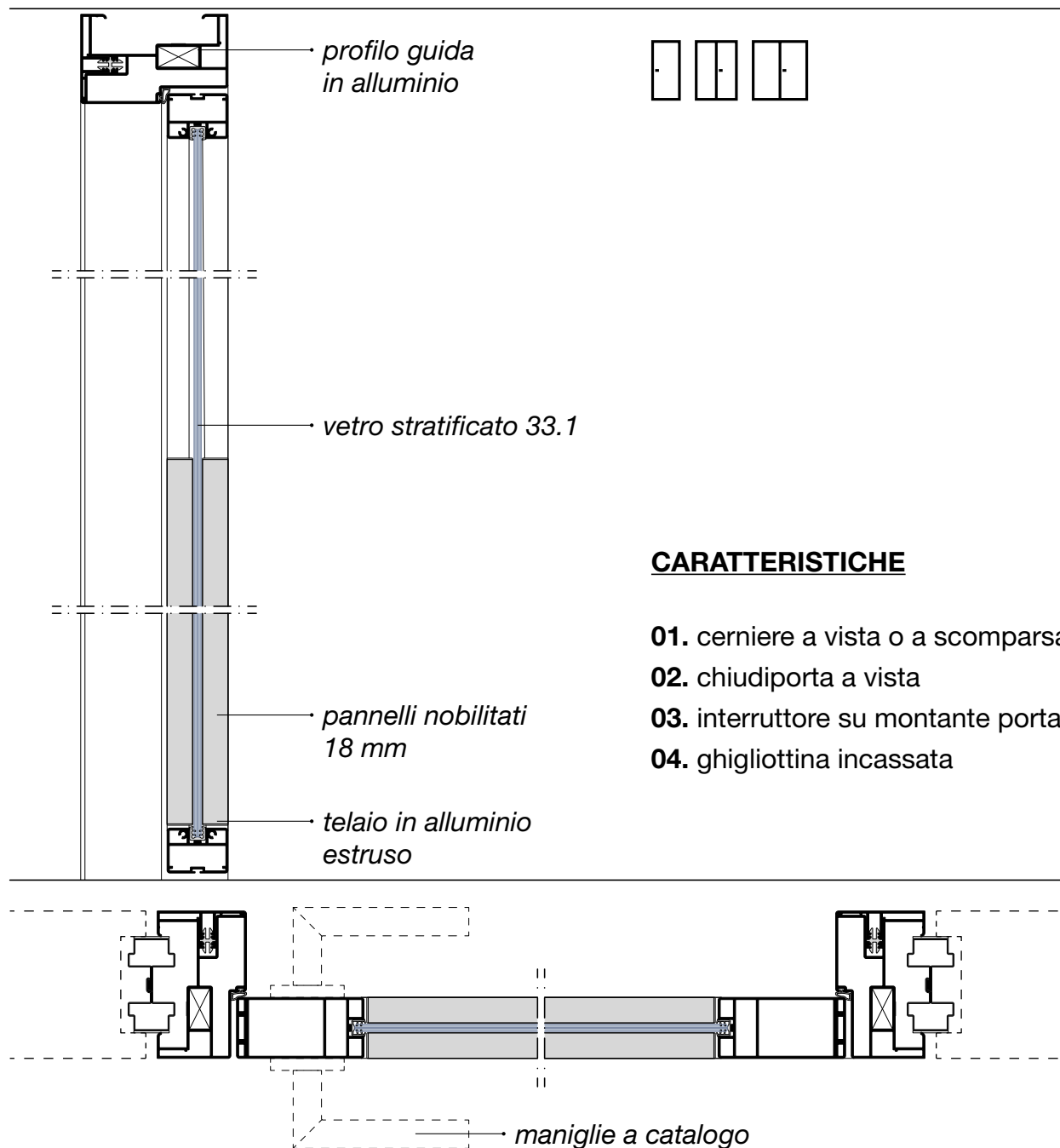



# ANTA INTELAIATA GRANDE CON PANNELLO sp. 43 mm

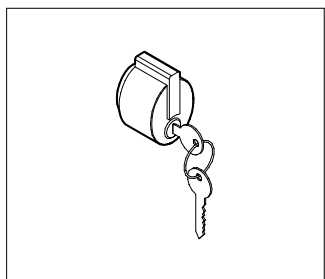

ML1

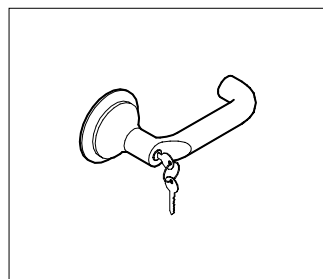

ML4

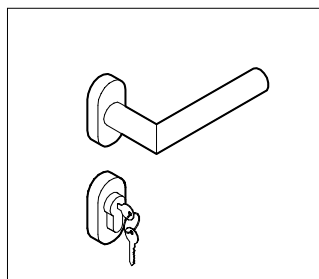

ML5

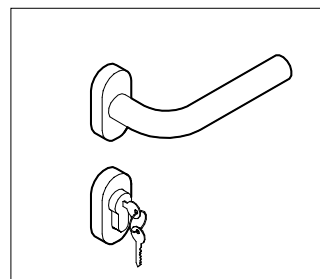

ML6

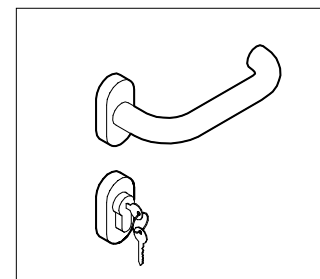

ML7

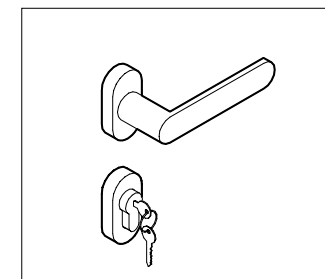

ML8

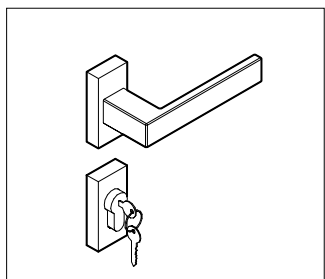

ML9

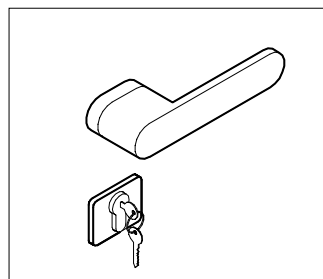

ML10

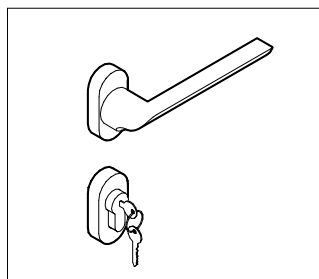

ML11

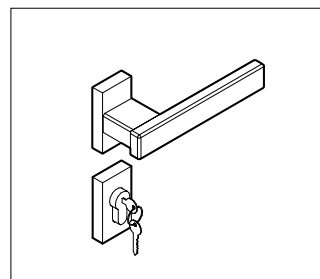

MLQ

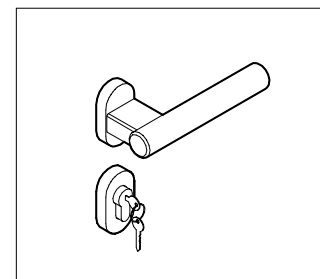

MLT

# ANTA INTELAIATA GRANDE sp. 43 mm

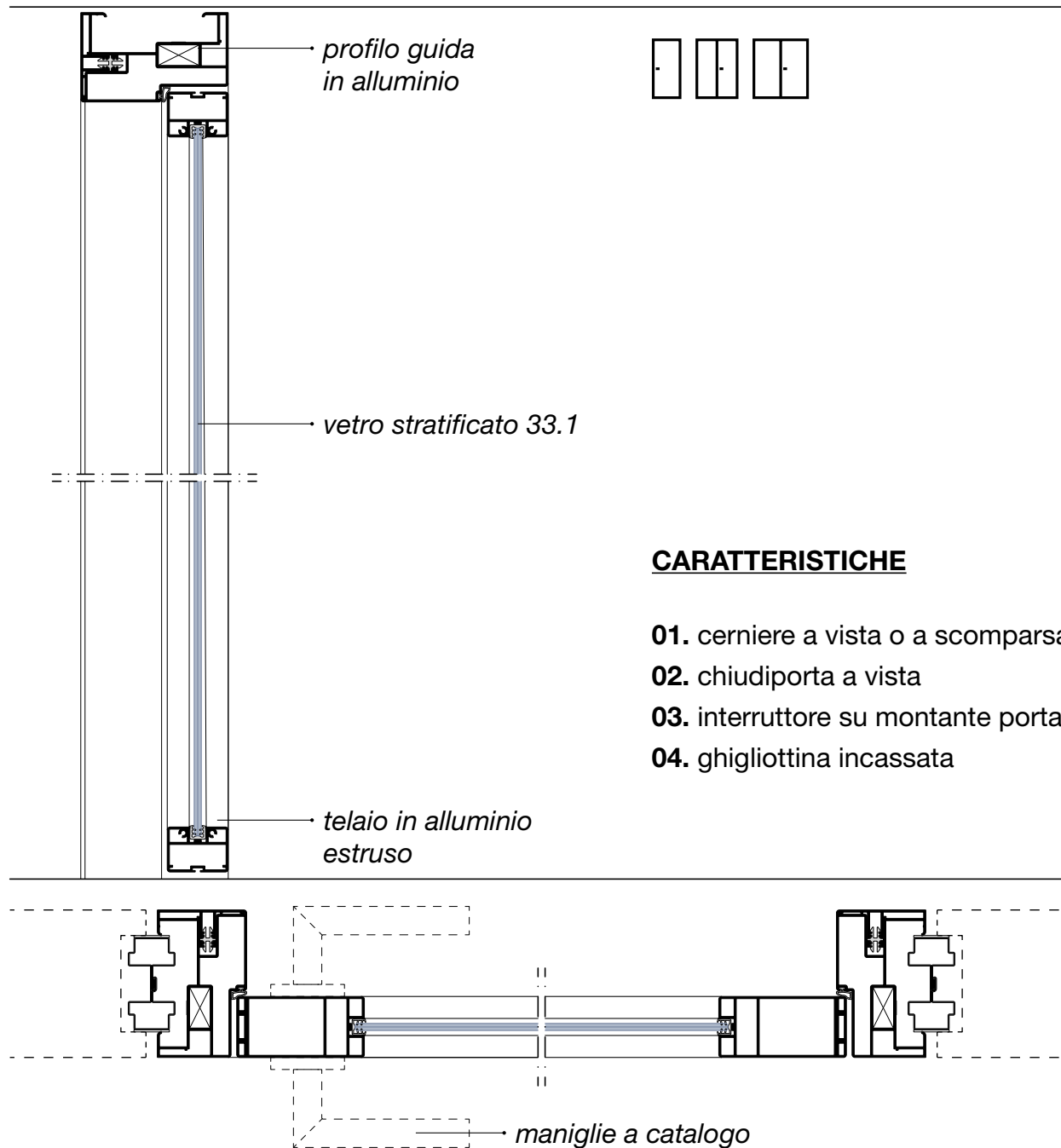

# ANTA INTELAIATA GRANDE sp. 43 mm

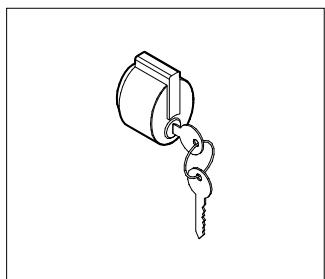

**ML1**

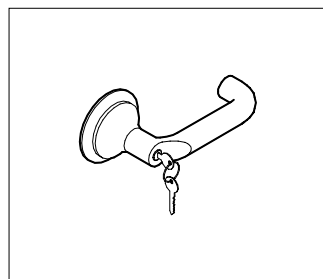

**ML4**

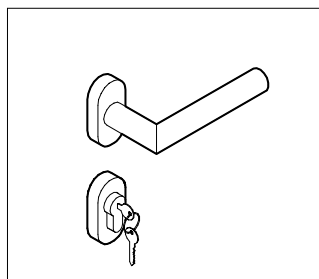

**ML5**

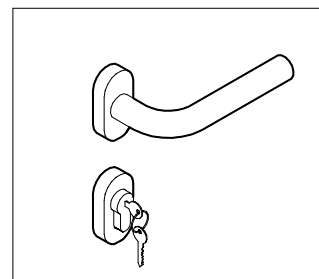

**ML6**

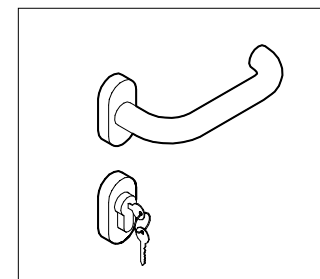

**ML7**

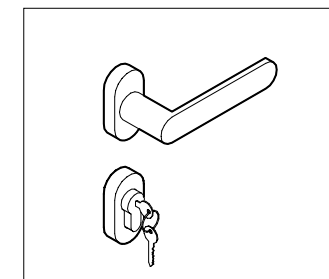

**ML8**

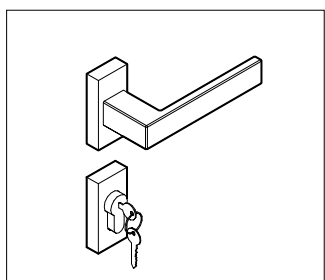

**ML9**

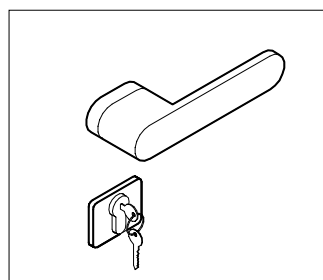

**ML10**

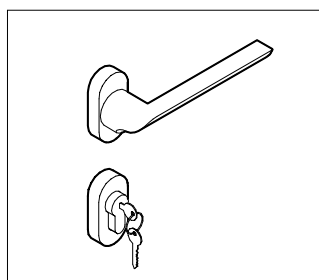

**ML11**

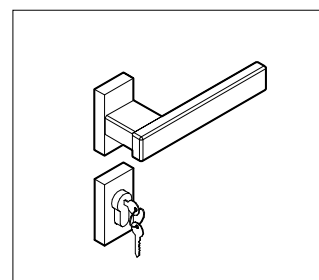

**MLQ**

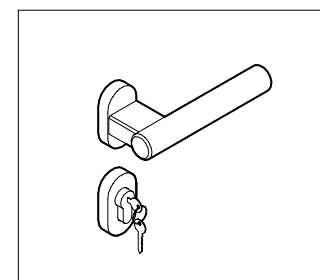

**MLT**

# ANTA INTELAIATA MEDIA sp. 43 mm

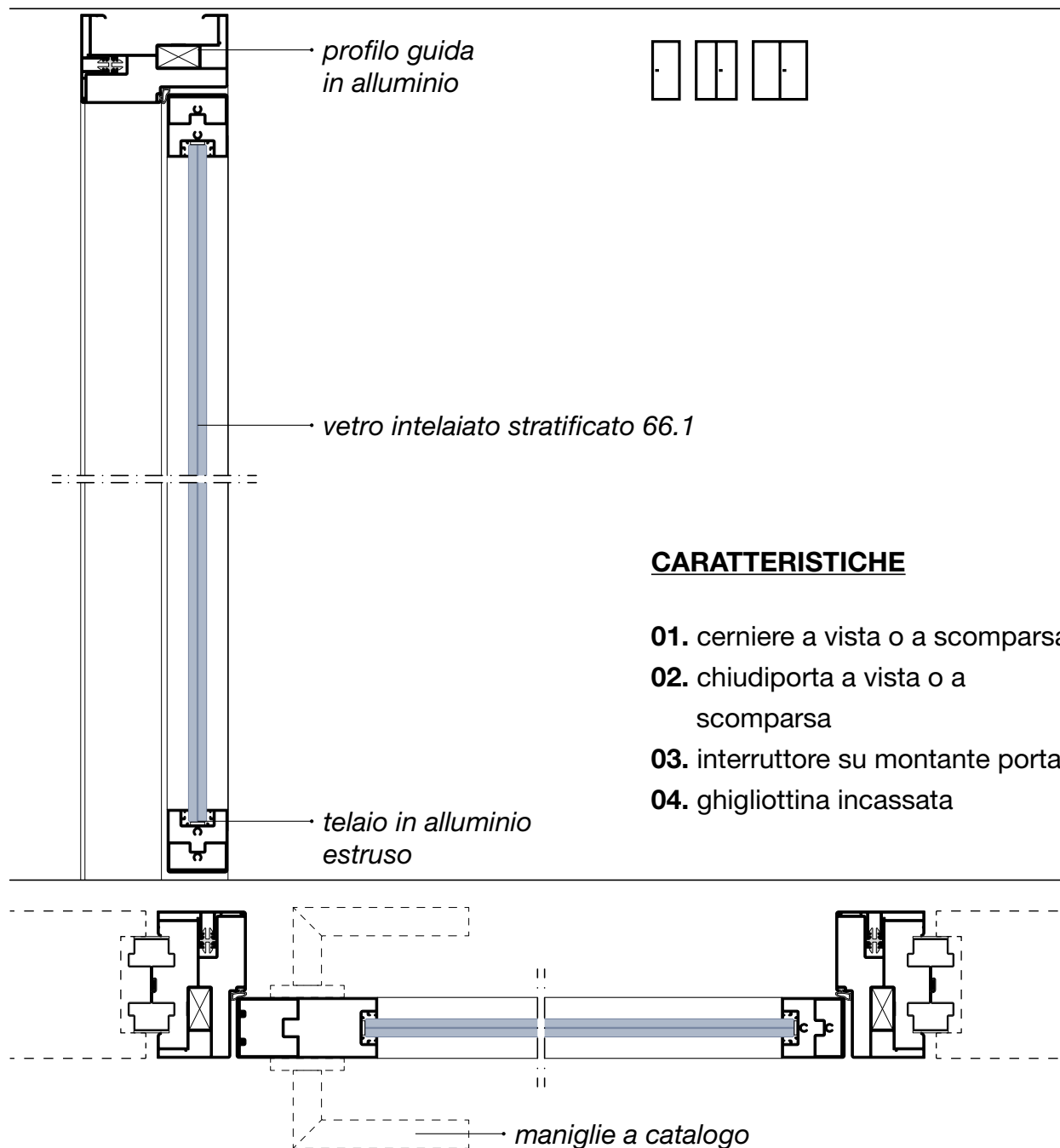

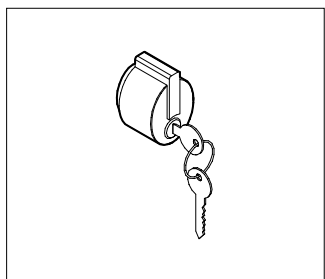

**ML1**

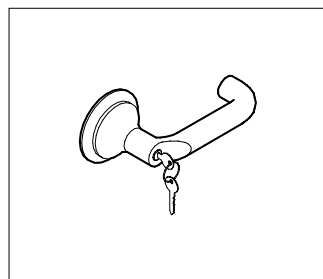

**ML4**

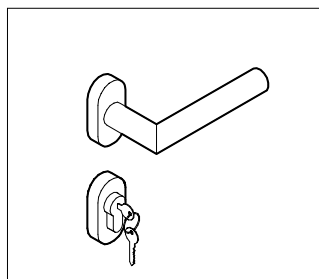

**ML5**

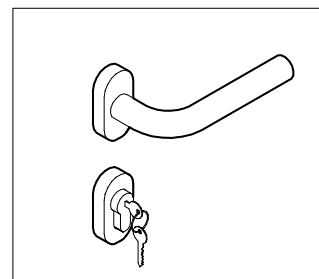

**ML6**

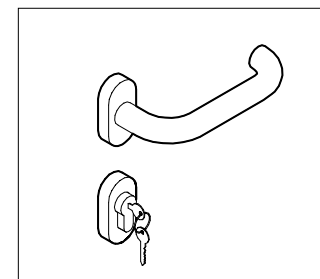

**ML7**

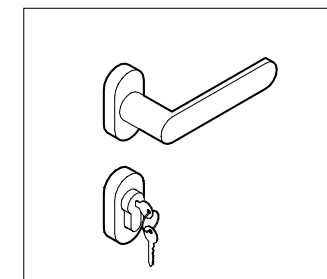

**ML8**

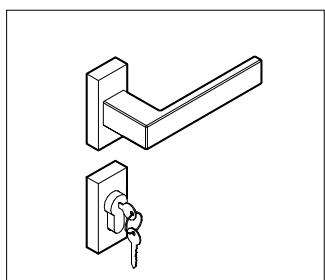

**ML9**

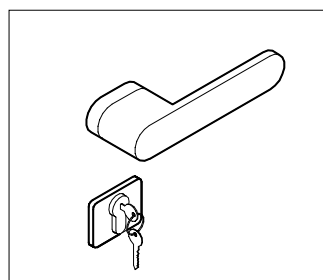

**ML10**

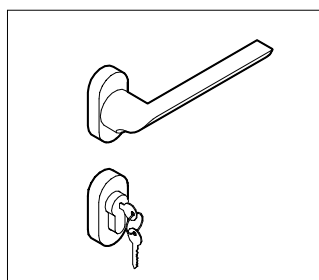

**ML11**

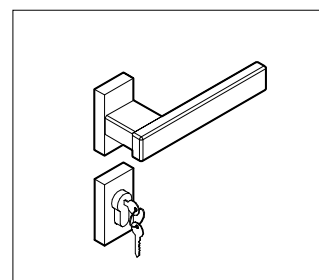

**MLQ**

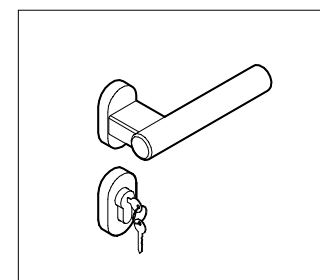

**MLT**

# ANTA INTELAIATA SOTTILE sp. 43 mm

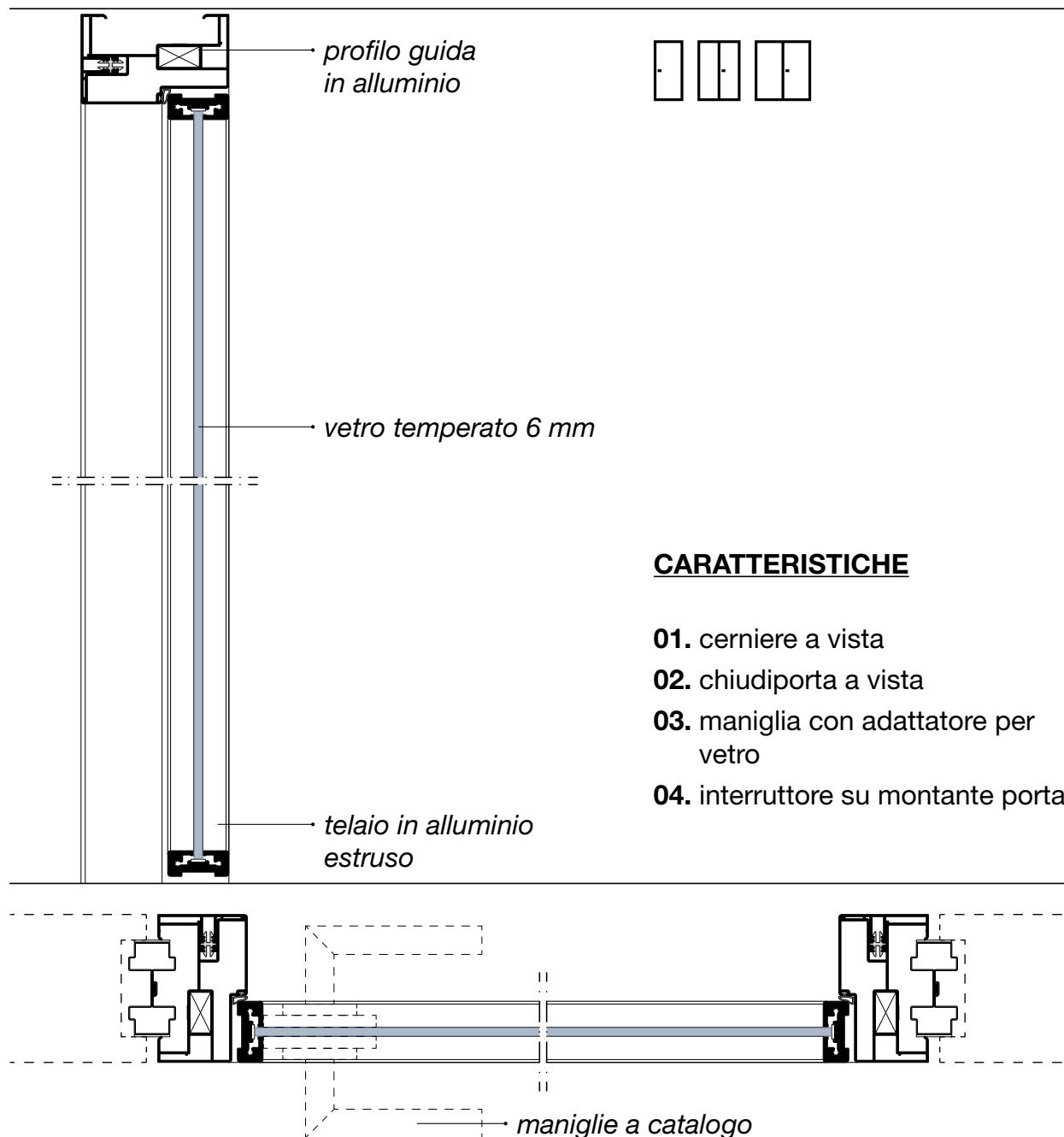

# ANTA INTELAIATA SOTTILE sp. 43 mm

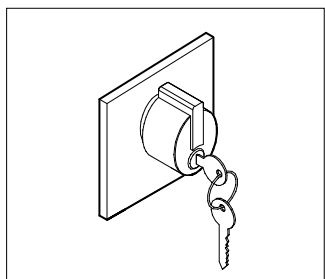

ML1

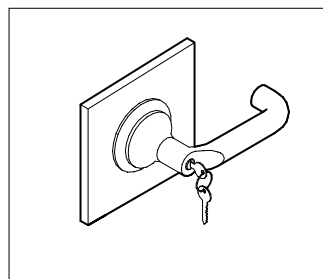

ML4

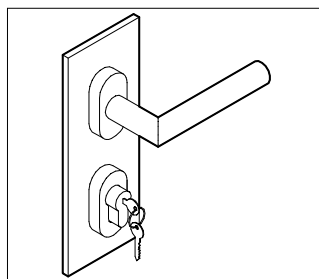

ML5

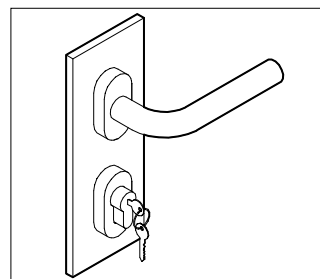

ML6

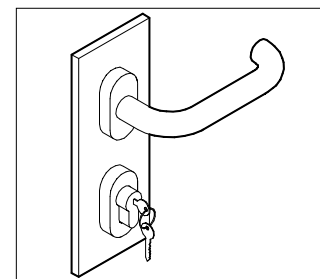

ML7

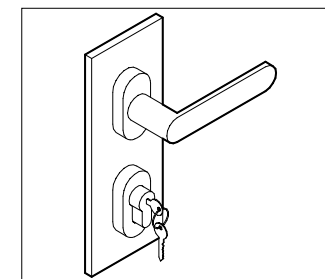

ML8

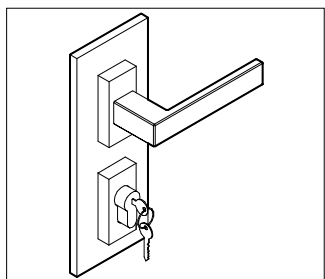

ML9

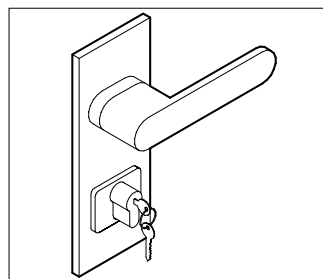

ML10

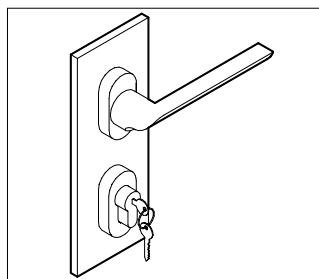

ML11

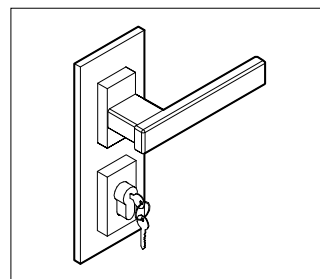

MLQ

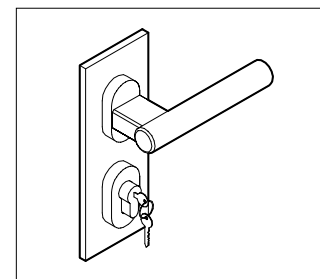

MLT

# ANTA INTELAIATA VETRO DOPPIO sp. 51 mm

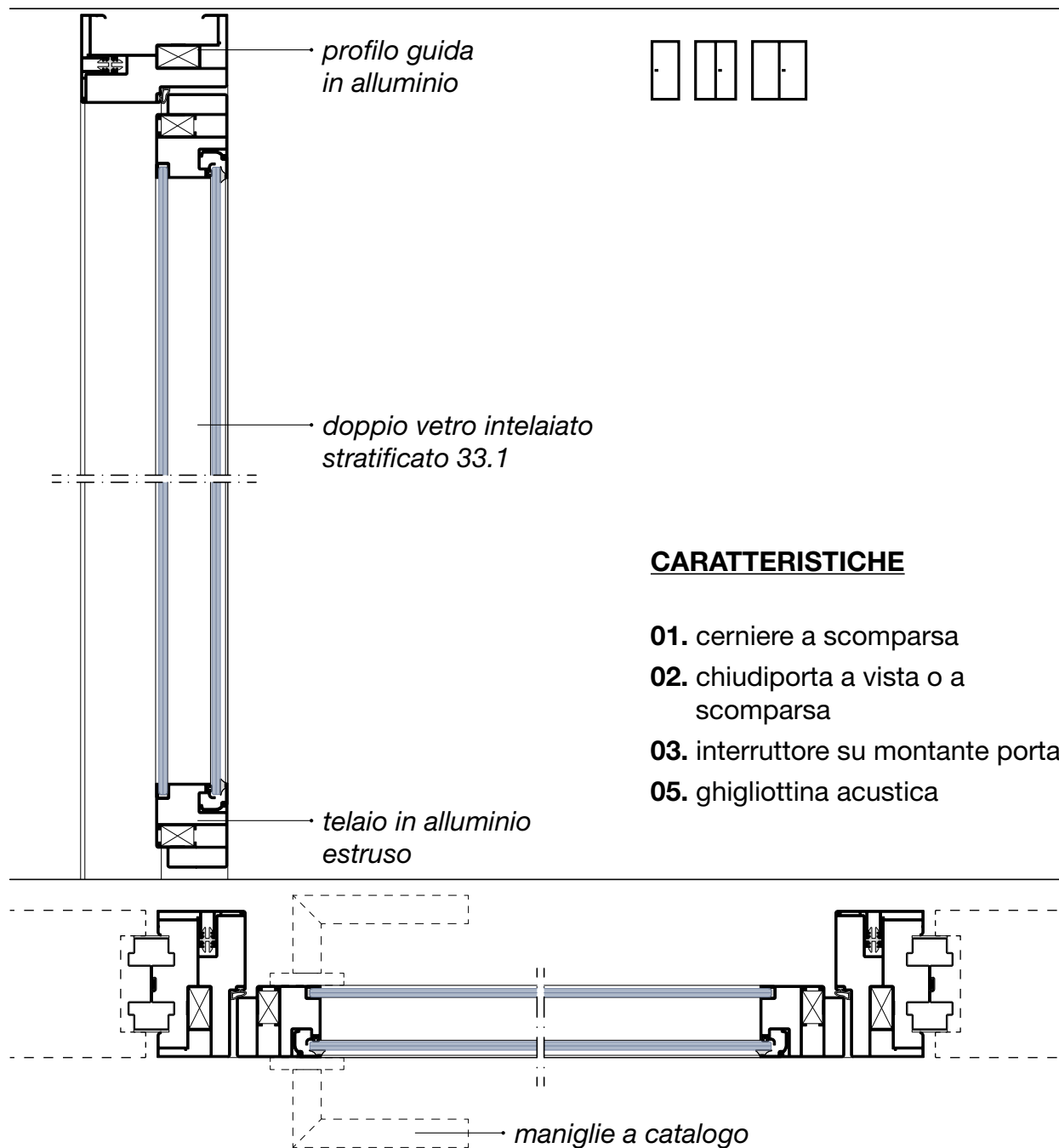



# ANTA INTELAIATA VETRO DOPPIO sp. 51 mm

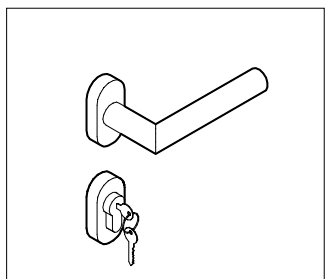

ML5

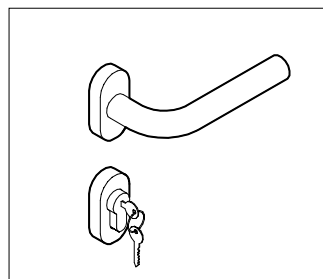

ML6

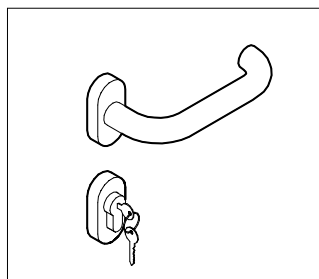

ML7

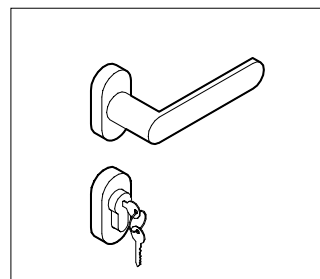

ML8

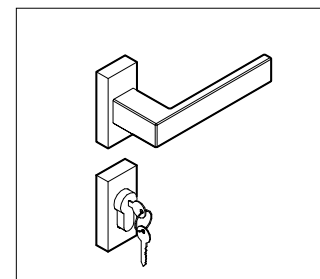

ML9

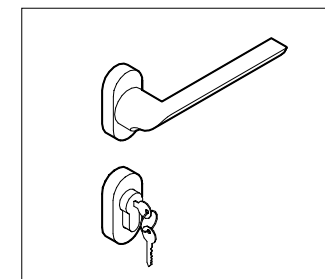

ML11

# ANTA INTELAIATA CIECA sp. 104 mm

Porta complanare

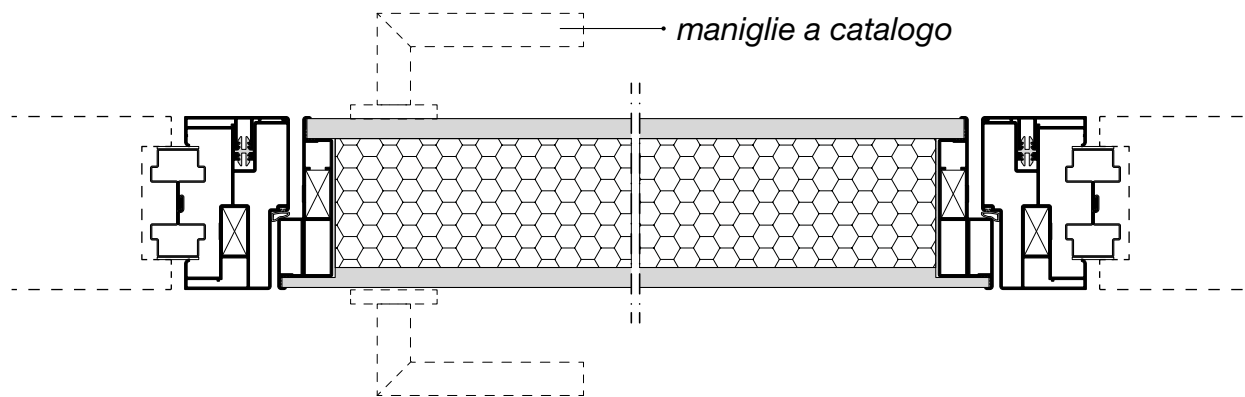
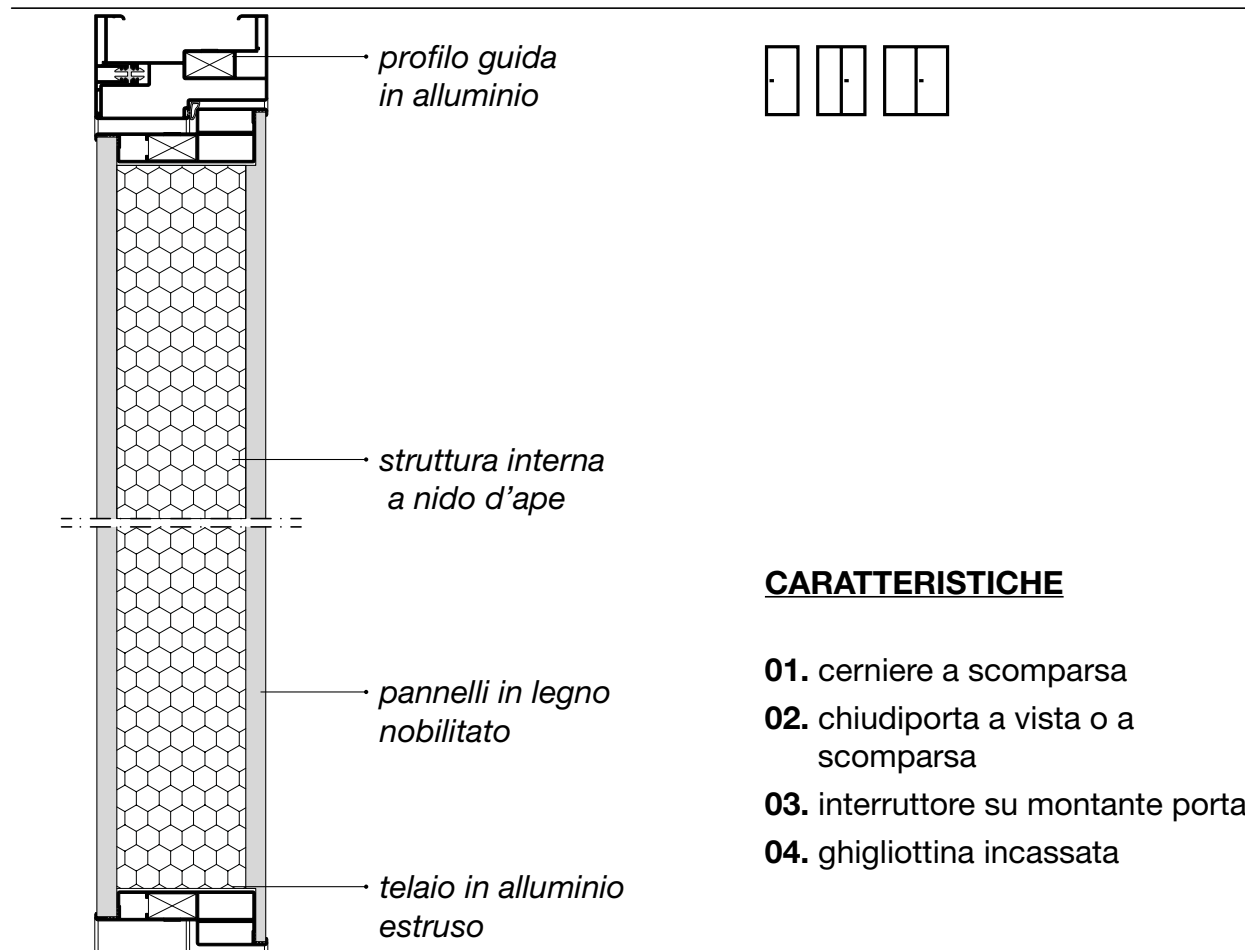

# ANTA INTELAIATA CIECA sp. 104 mm

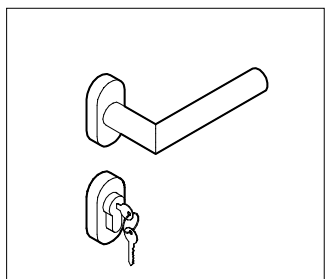

**ML5**

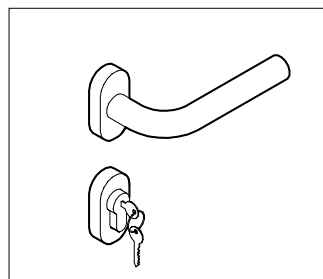

**ML6**

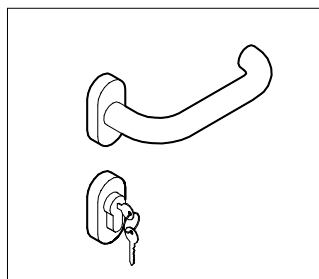

**ML7**

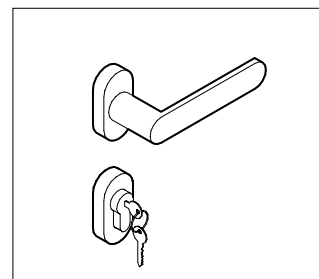

**ML8**

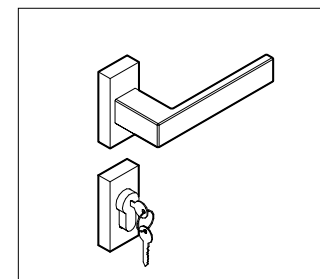

**ML9**

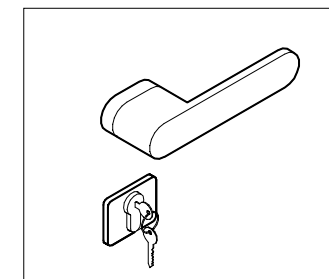

**ML10**

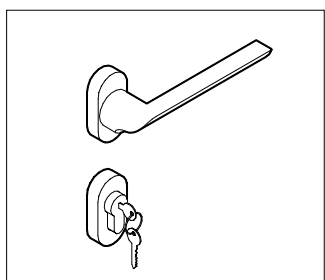

**ML11**

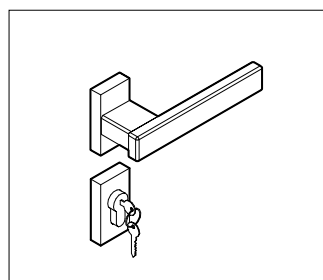

**MLQ**

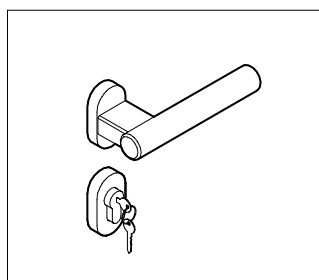

**MLT**

# ANTA INTELAIATA VETRO DOPPIO sp. 104 mm

Porta complanare

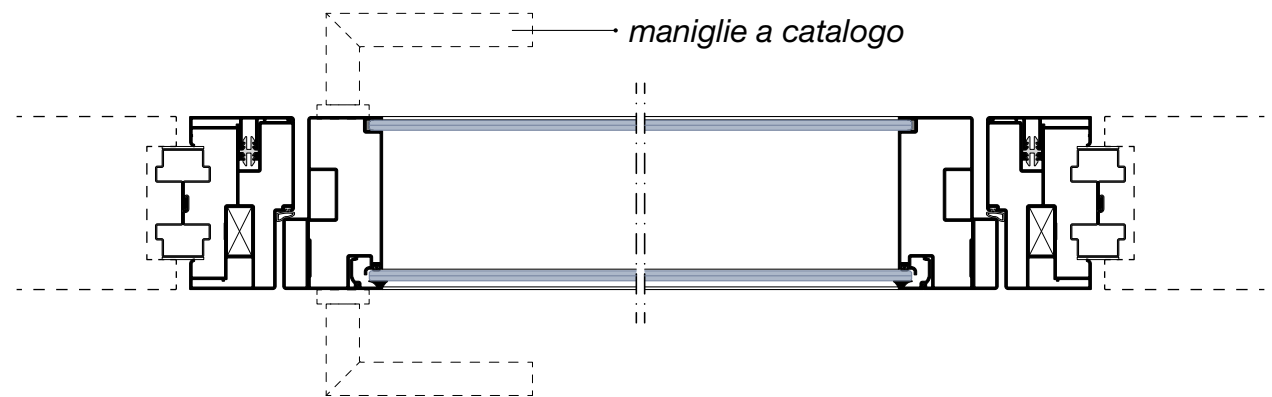
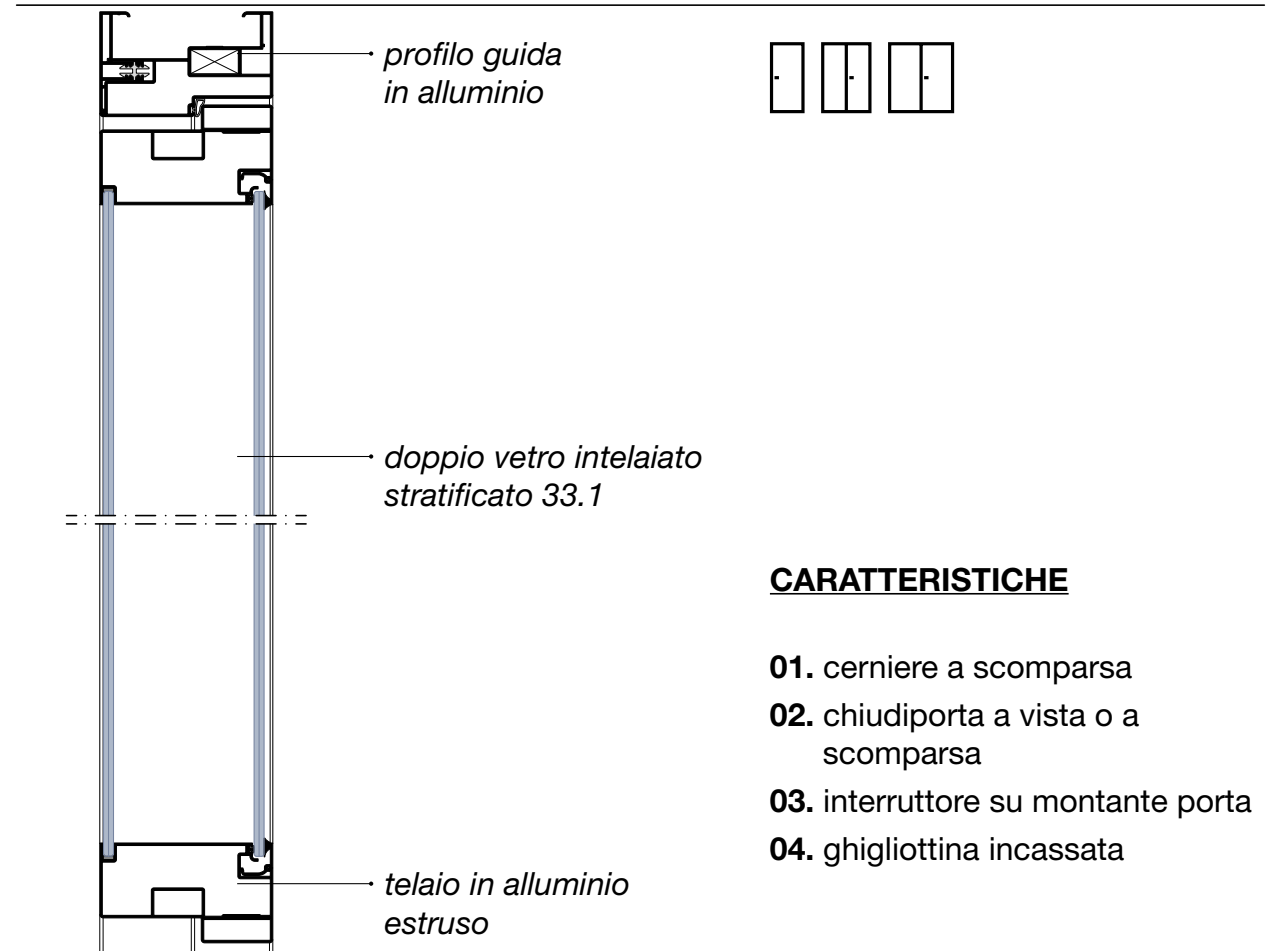

# ANTA INTELAIATA VETRO DOPPIO sp. 104 mm

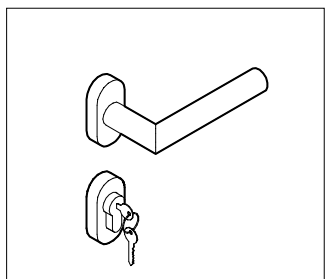

ML5

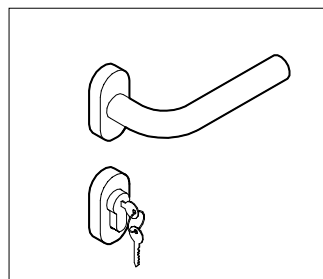

ML6

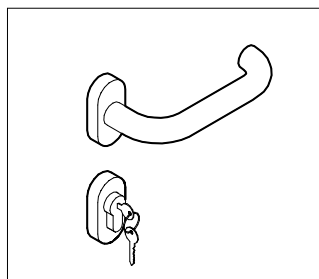

ML7

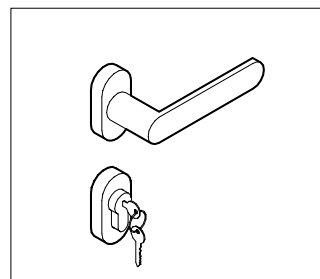

ML8

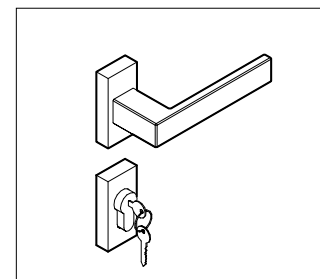

ML9

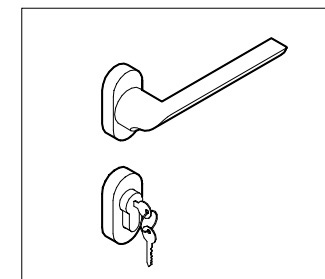

ML11

# TELAI PORTE BATTENTI



Telaio porta **Metrica D** su **Metrica R**

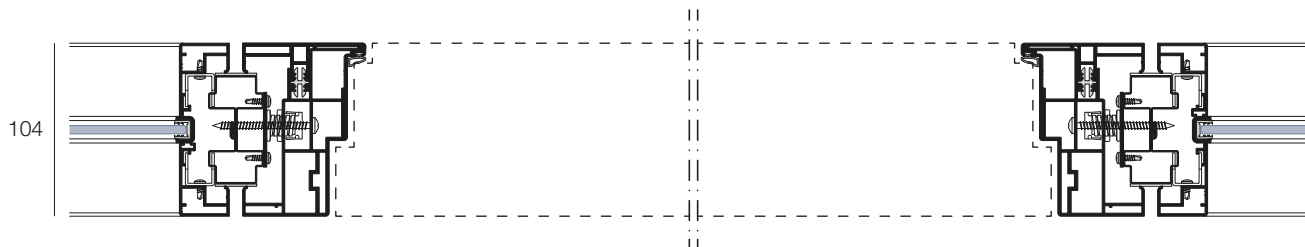

Telaio porta **Metrica D** su **Metrica V**

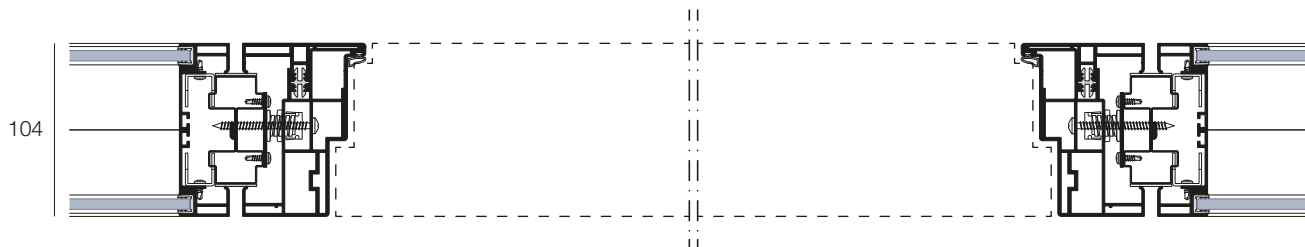

Telaio porta **Metrica D** su **Metrica S**

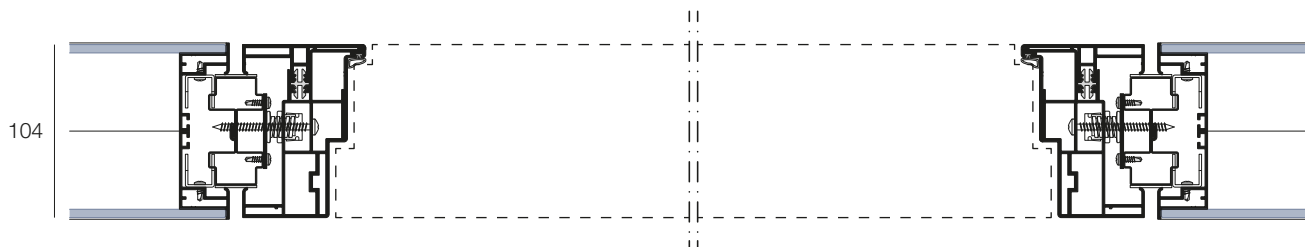

Telaio porta **Metrica D** su **Metrica Solid**

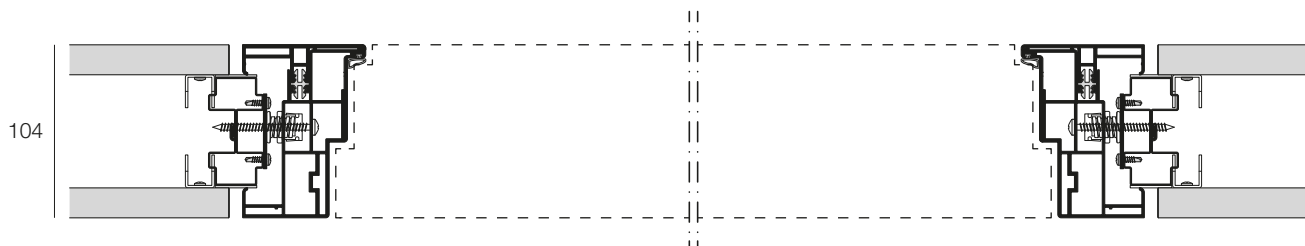

# ANTA INTELAIATA CIECA\_CON DOPPIA BATTUTA sp. 104 mm



Porta complanare

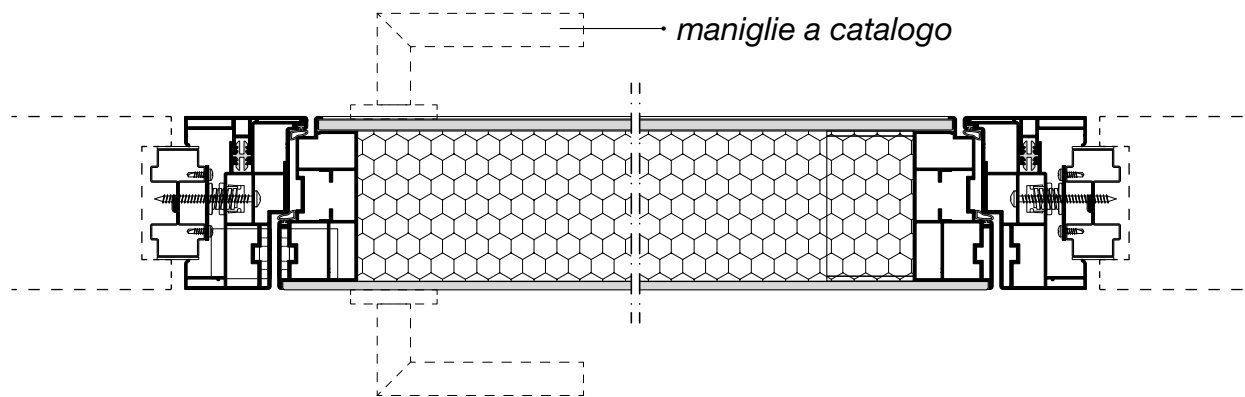
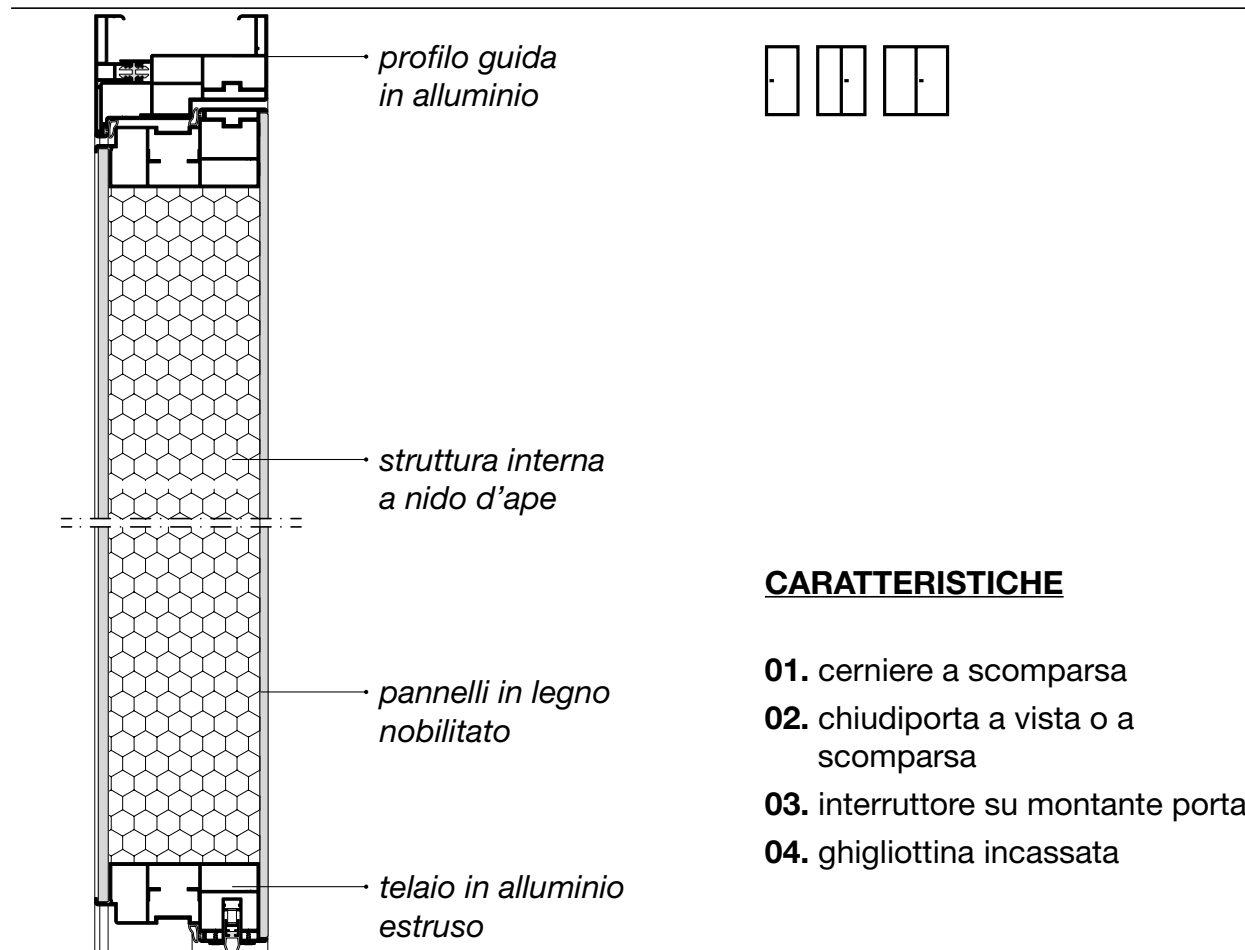

# ANTA INTELAIATA CIECA\_CON DOPPIA BATTUTA sp. 104 mm

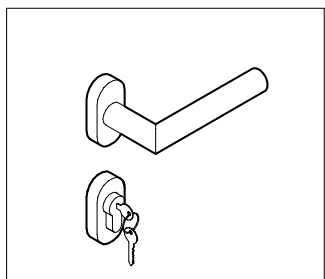

**ML5**

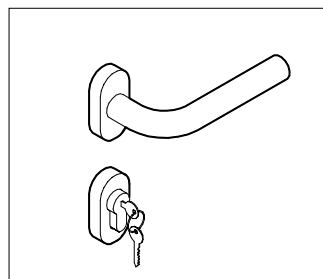

**ML6**

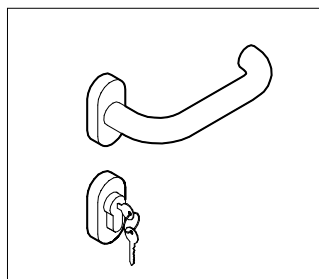

**ML7**

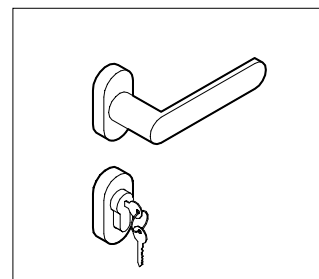

**ML8**

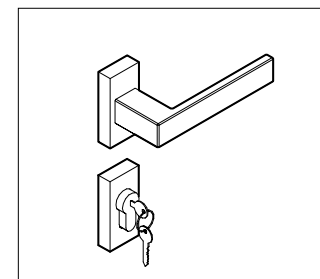

**ML9**

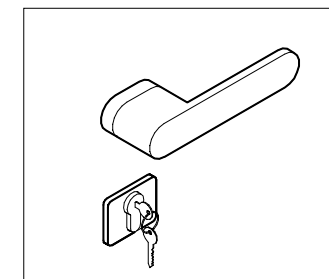

**ML10**

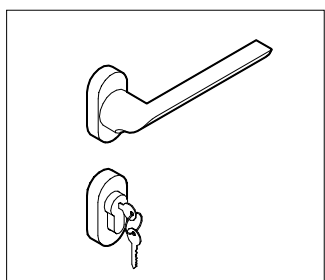

**ML11**

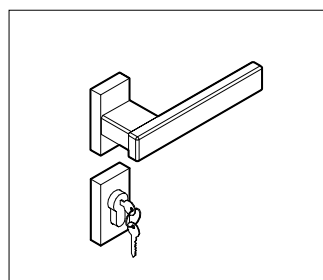

**MLQ**

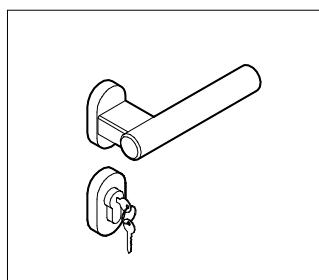

**MLT**



# ANTA INTELAIATA VETRO DOPPIO SERIGRAFATO\_CON DOPPIA BATTUTA sp. 104 mm



Porta complanare

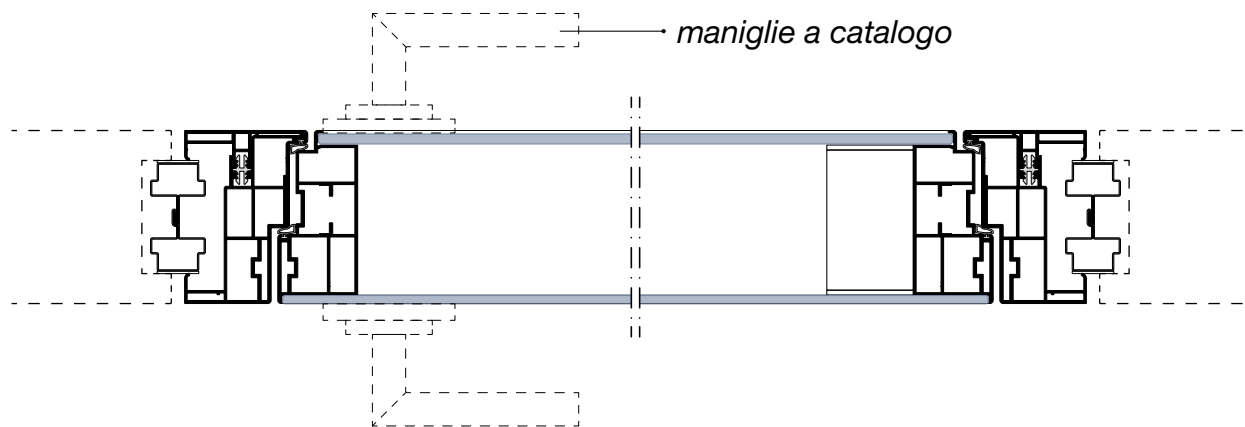
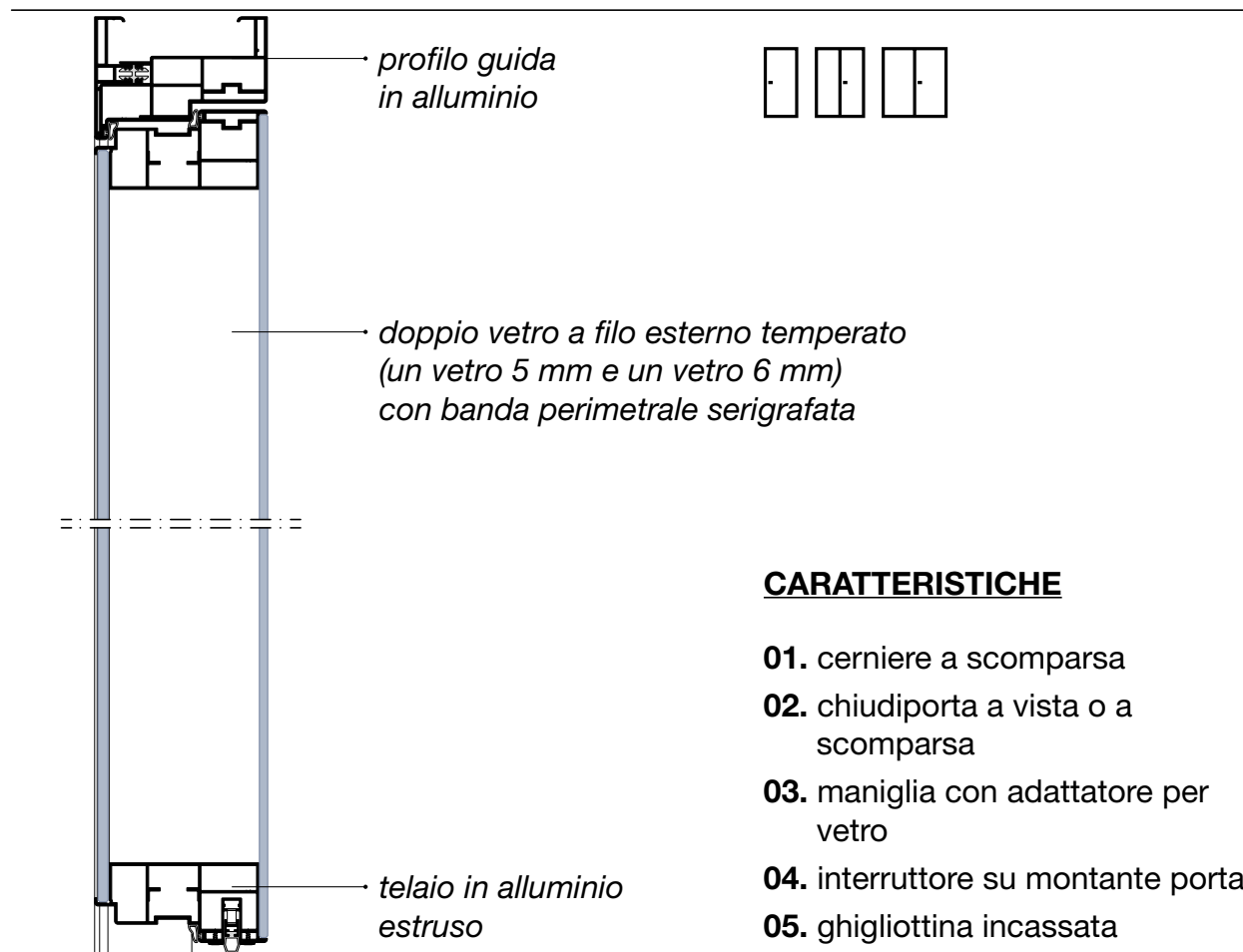

# ANTA INTELAIATA VETRO DOPPIO SERIGRAFATO\_CON DOPPIA BATTUTA sp. 104 mm

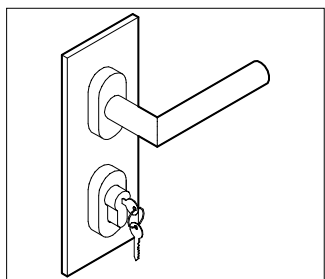

**ML5**

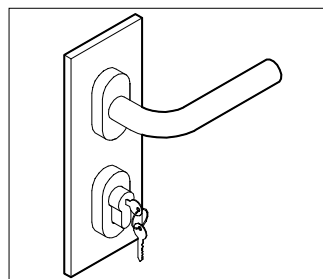

**ML6**

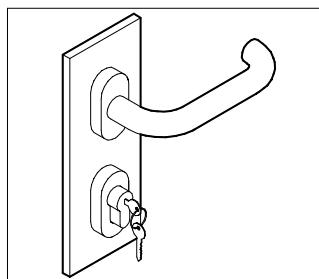

**ML7**

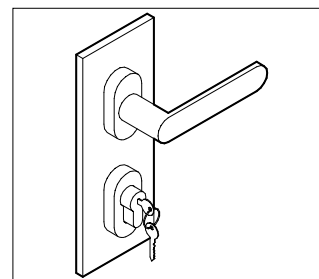

**ML8**

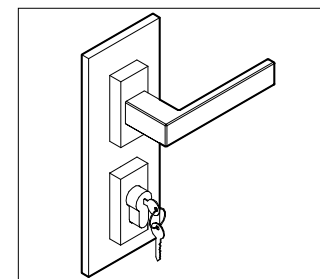

**ML9**

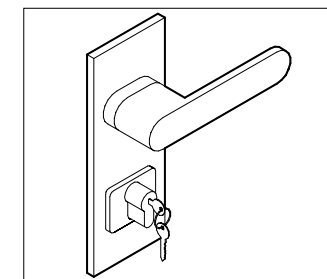

**ML10**

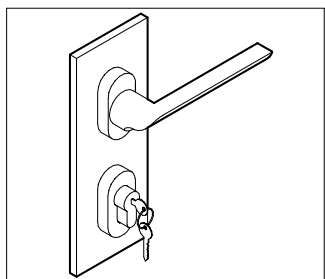

**ML11**

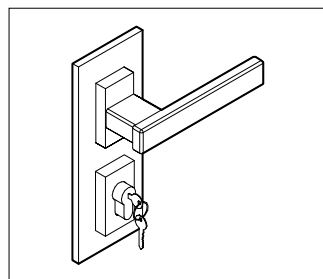

**MLQ**

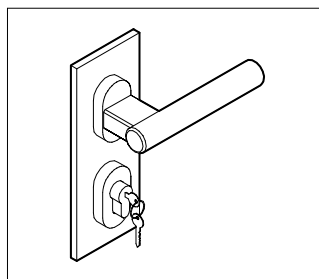

**MLT**

# TELAI PORTE SCORREVOLI



Telaio porta su **Metrica R**



Telaio porta su **Metrica V**

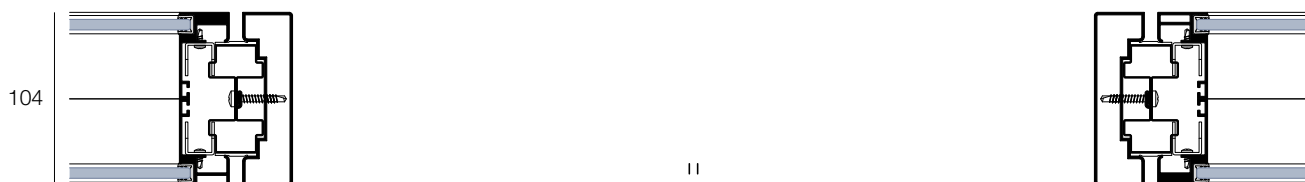

Telaio porta su **Metrica S**

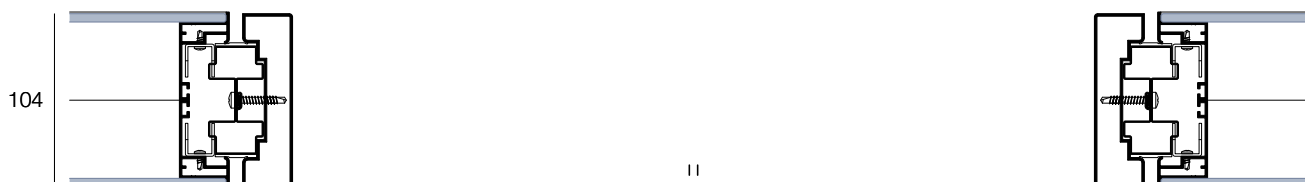

Telaio porta su **Metrica Solid**

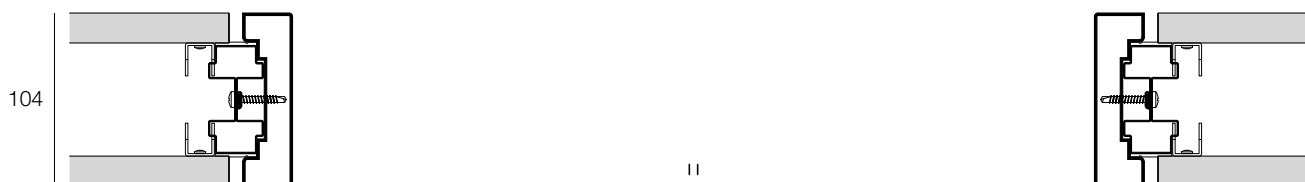

\* Connessione del telaio della porta scorrevole sulle varie pareti metrica

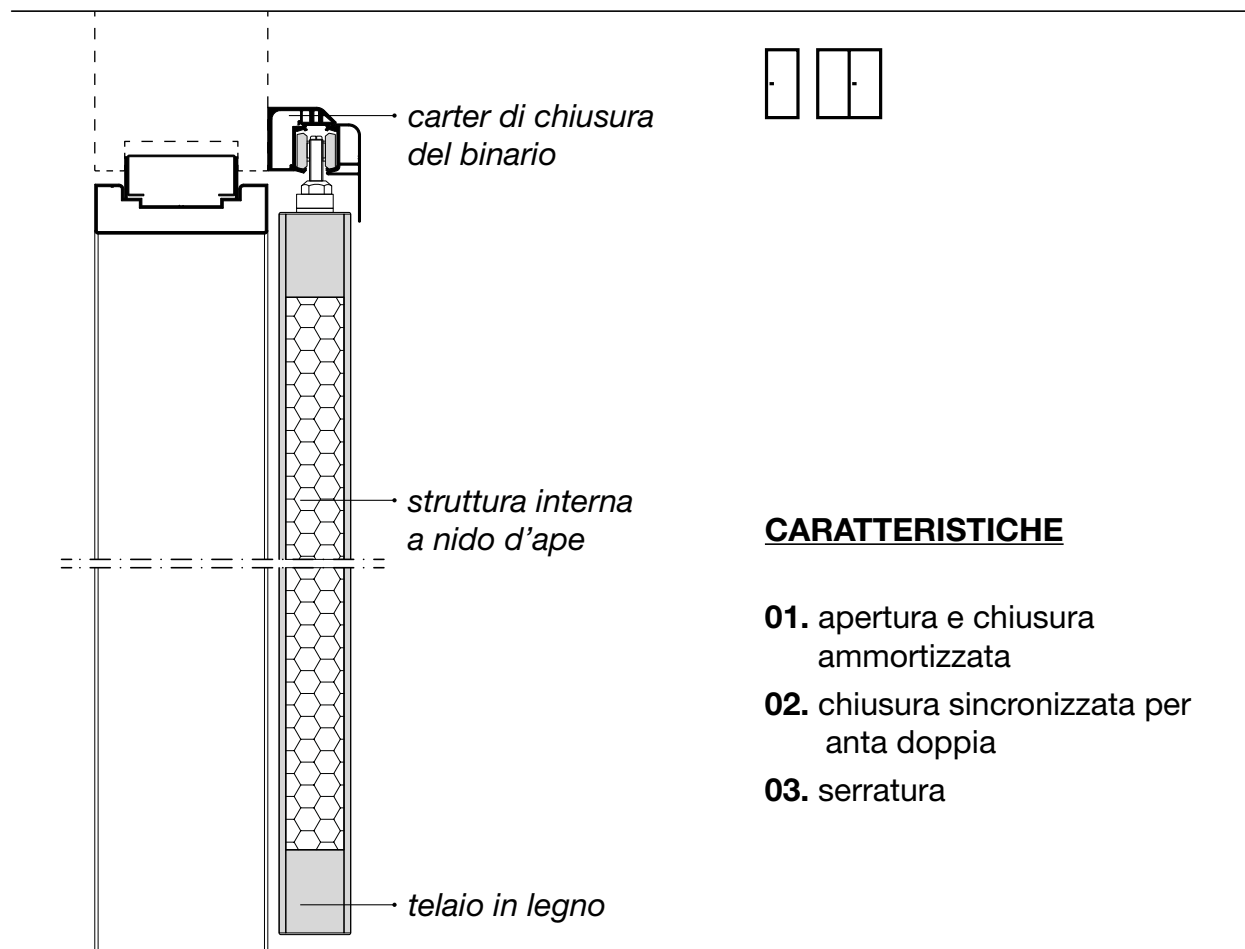

### **CARATTERISTICHE**

- 01.** apertura e chiusura ammortizzata
- 02.** chiusura sincronizzata per anta doppia
- 03.** serratura

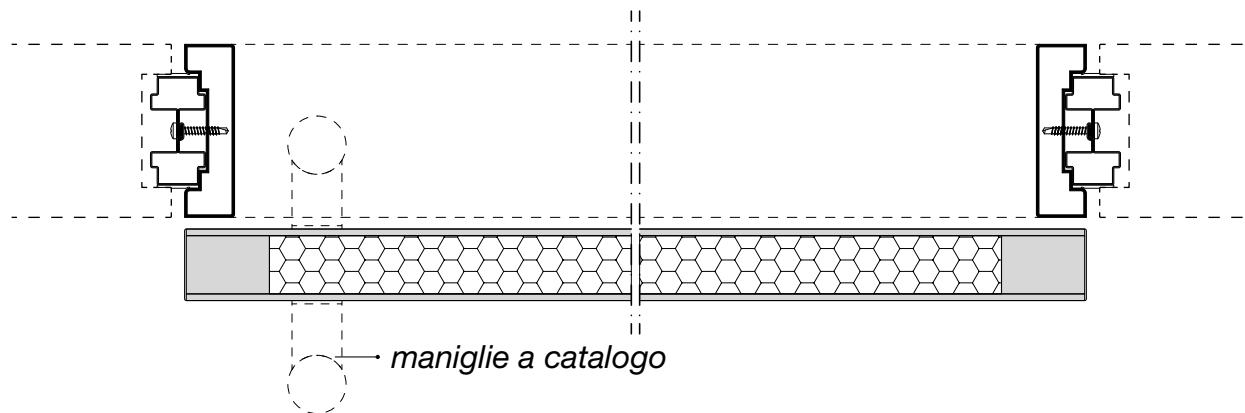

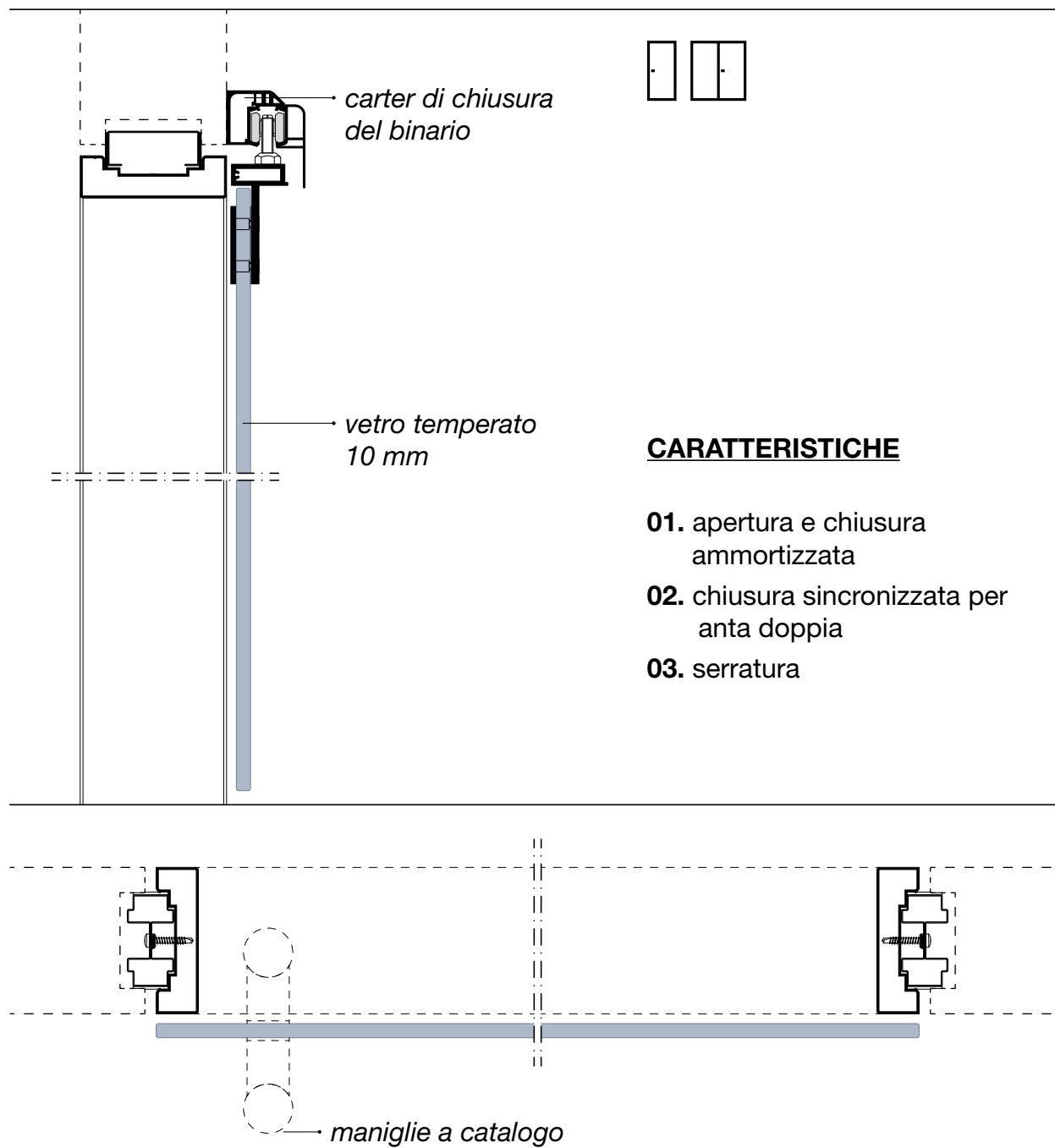

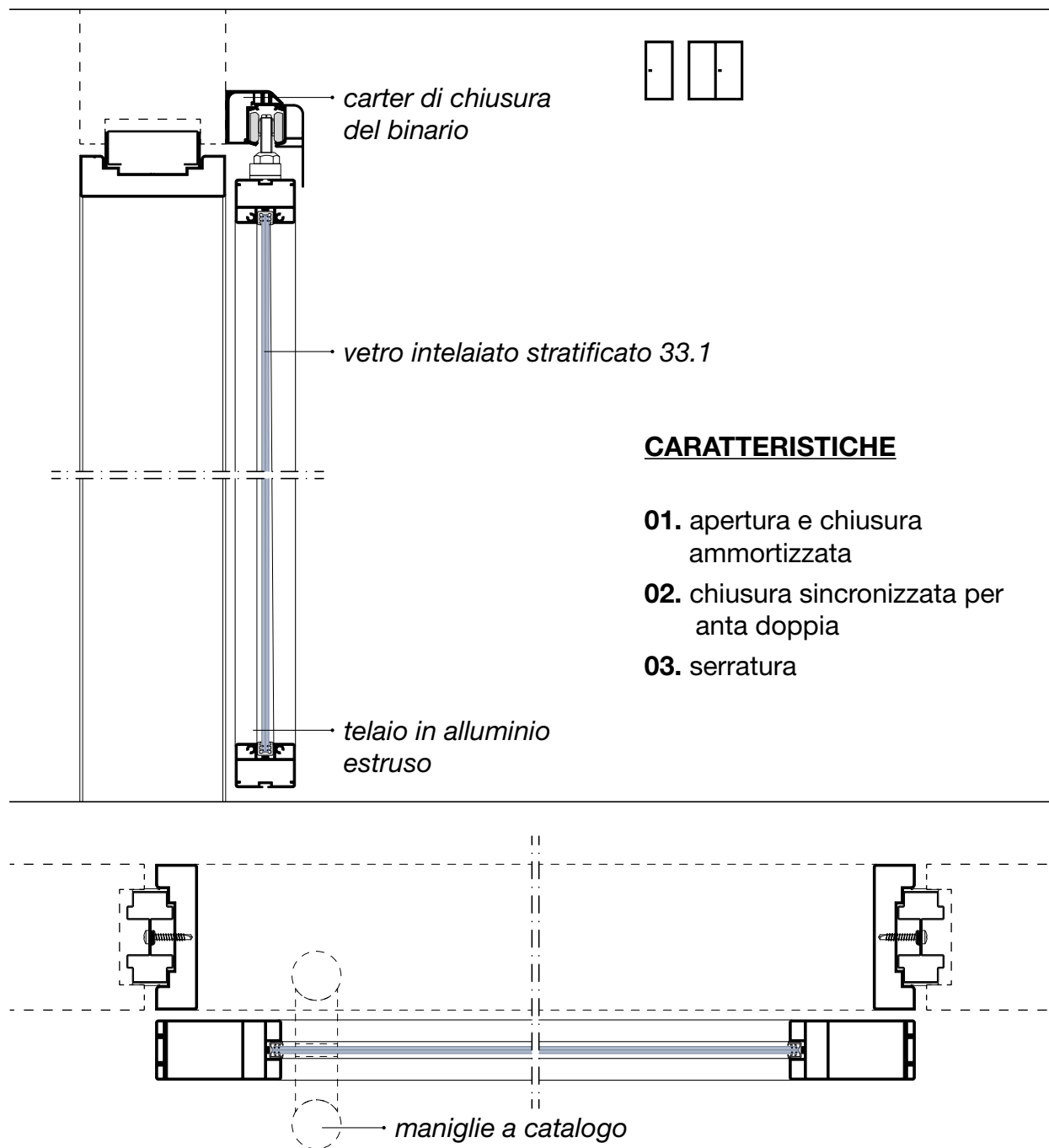

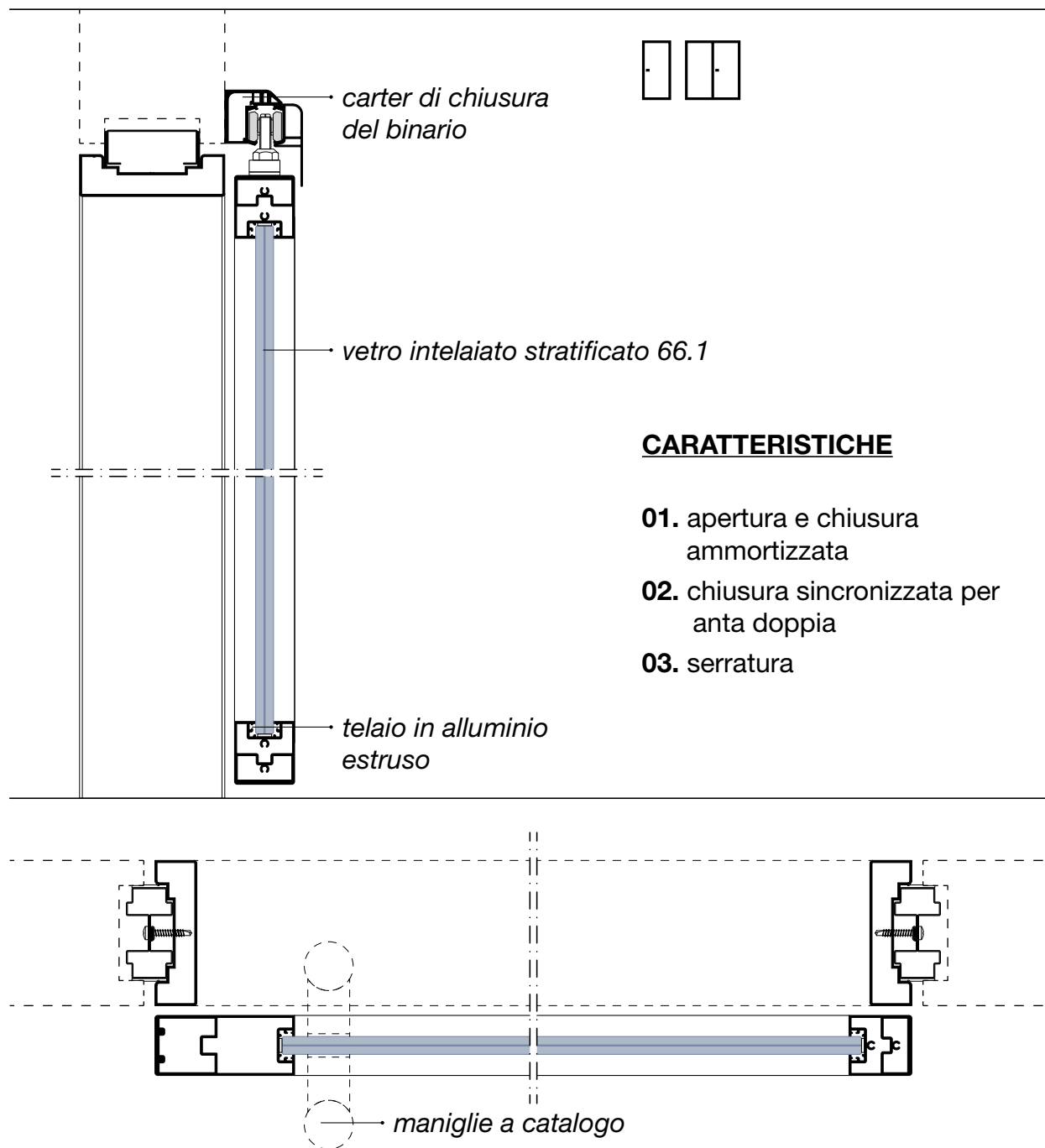

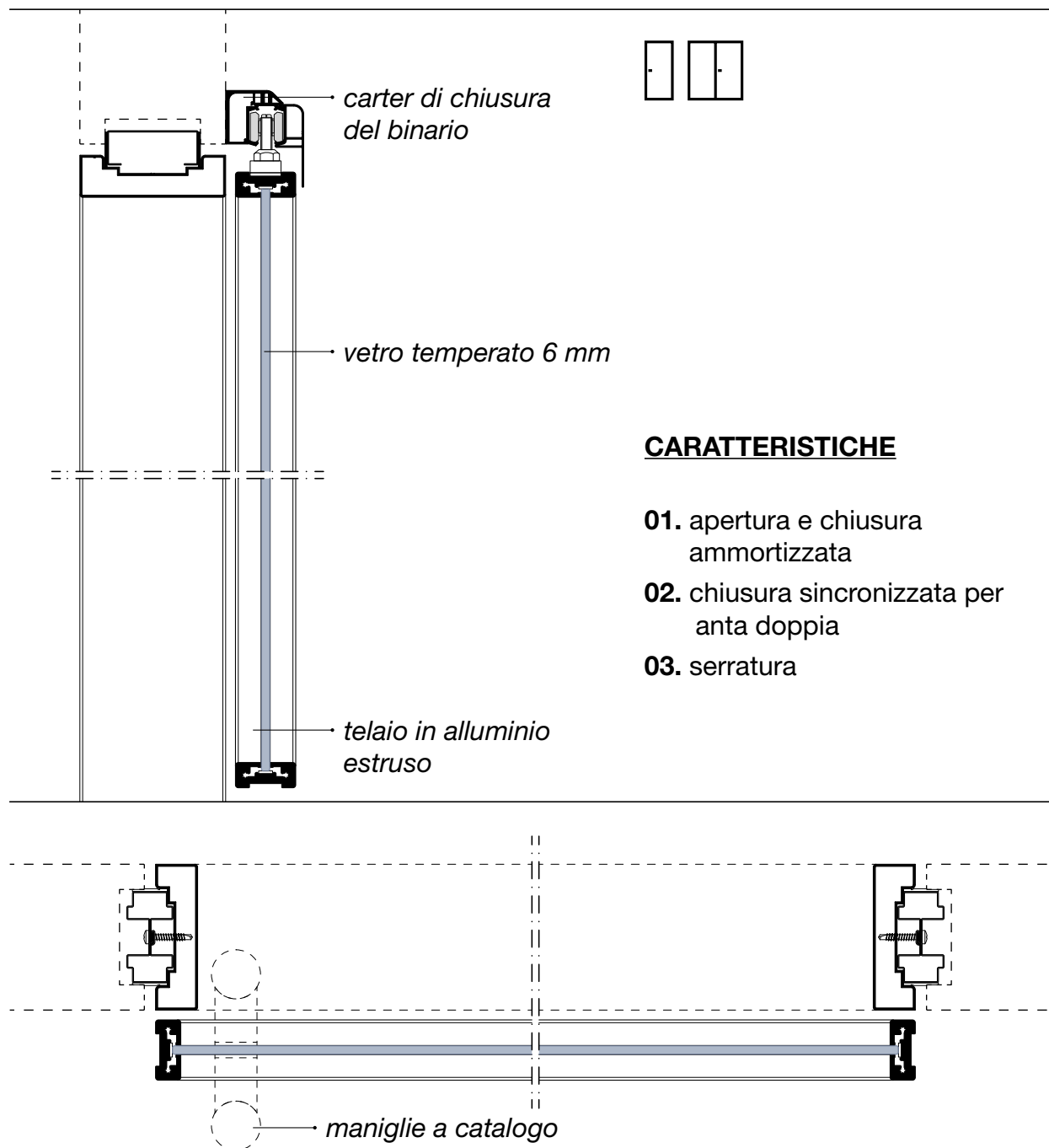



# ANTA CIECA\_SCORREVOLE INTERNA sp. 38 mm

\*solo per Metrica Solid

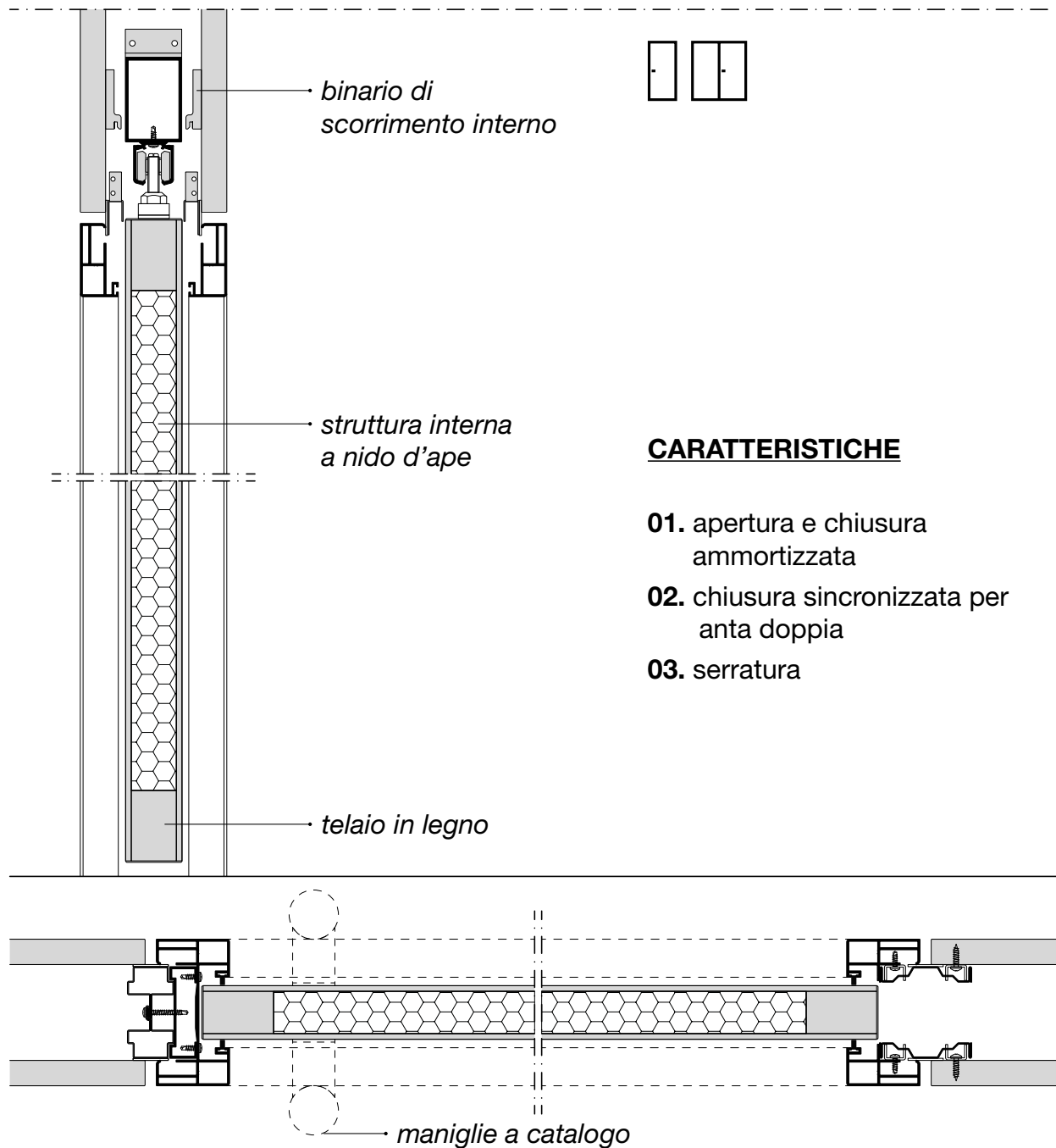

# ANTA VETRO TEMPERATO\_SCORREVOLE INTERNA sp. 10 mm

\*solo per Metrica Solid

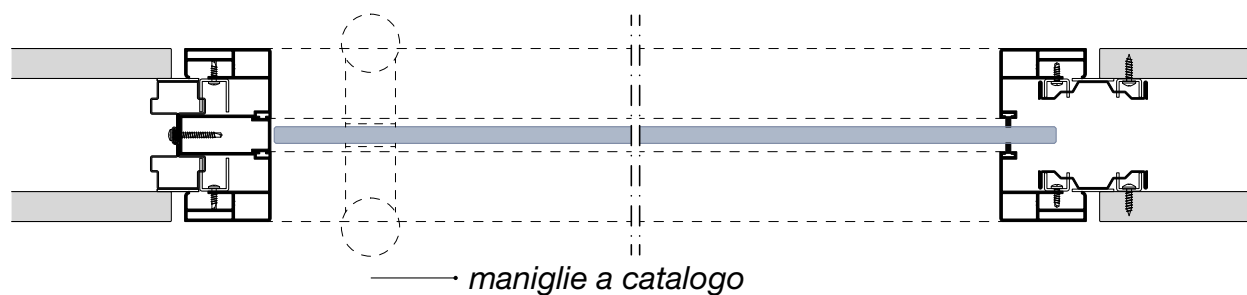
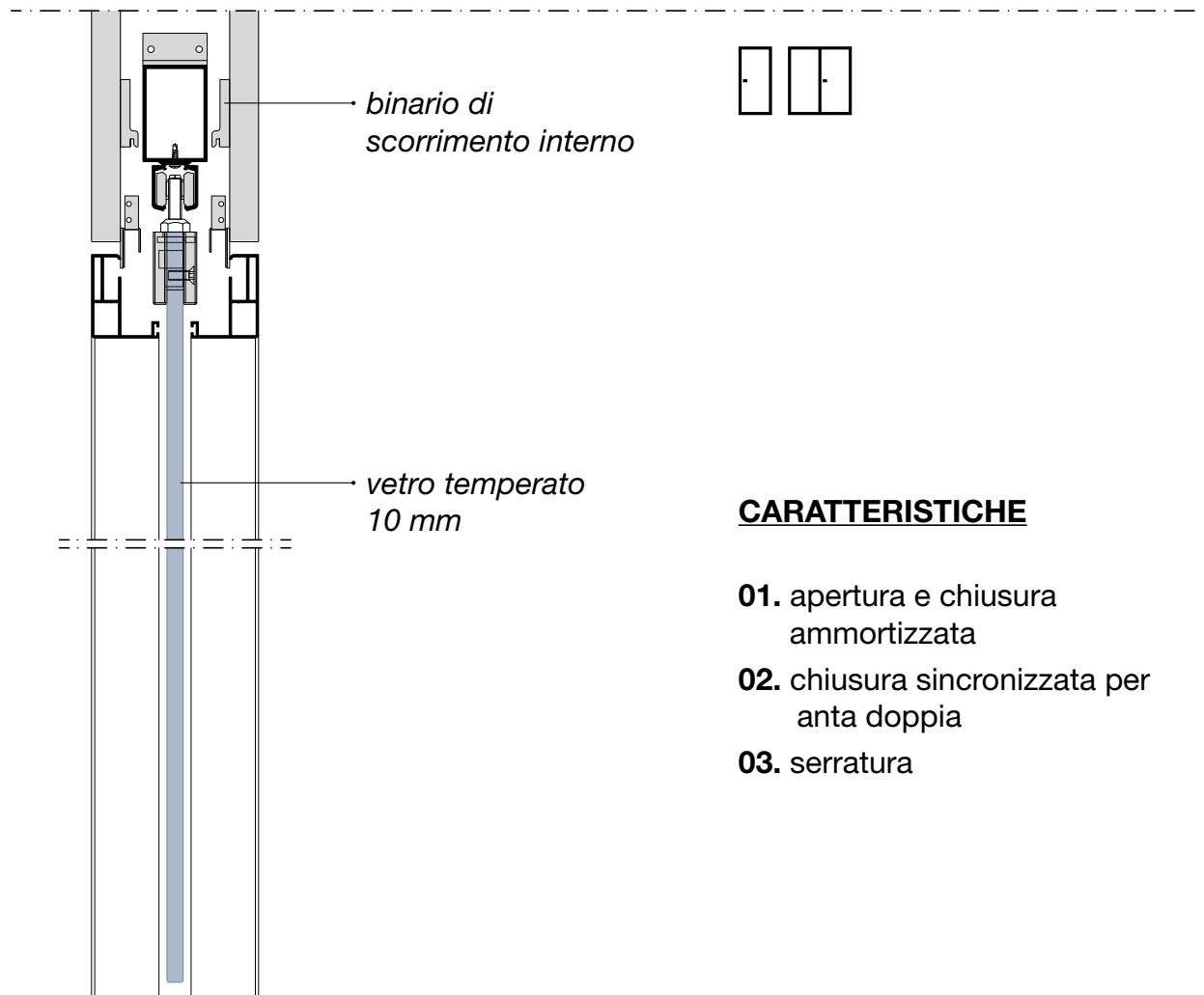
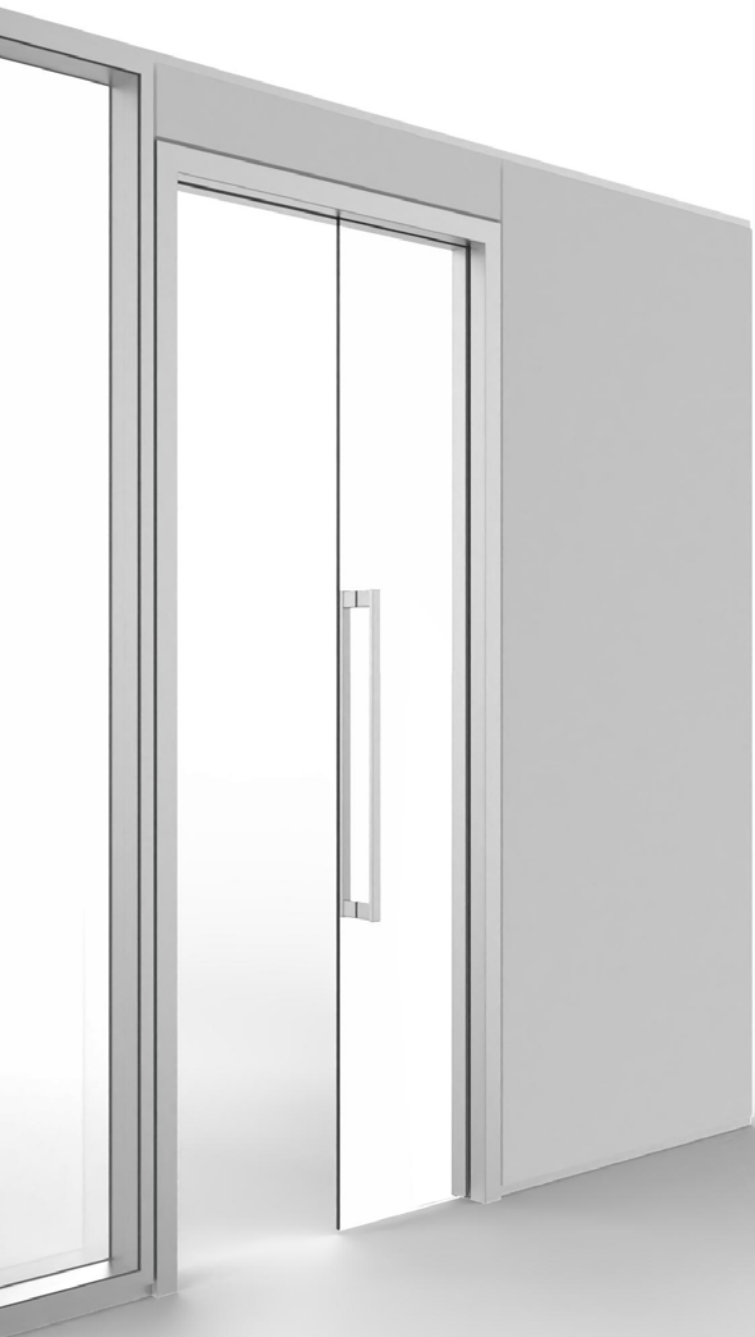

# Porte in vetro



ACCIAIO

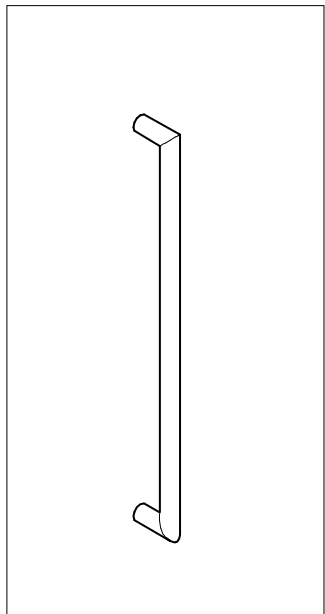

**MPOMGH1\_H2\_H3**

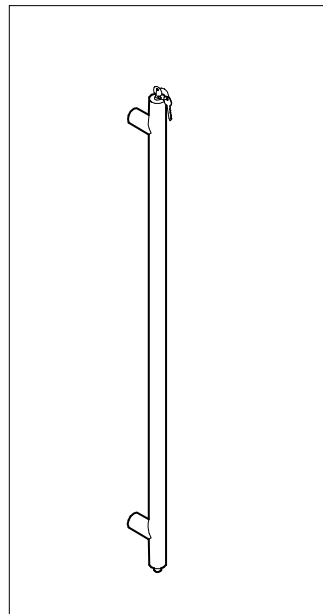

**MPOM2**

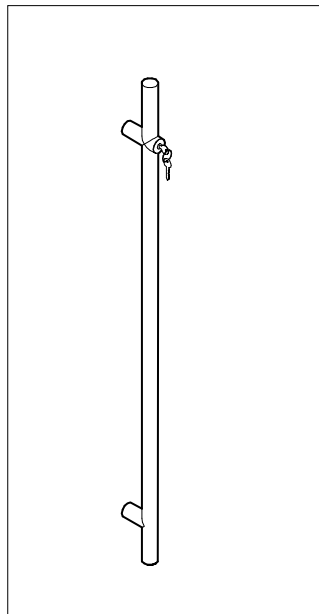

**MPOM3**

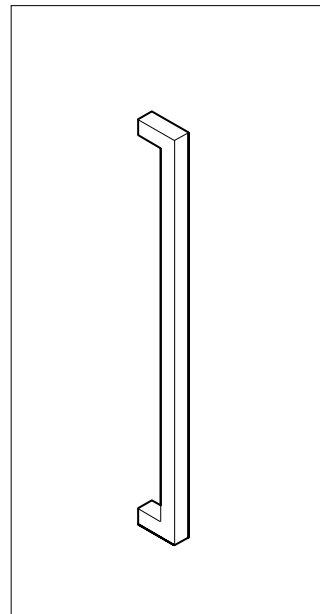

**MPOMGH1Q\_GH2Q\_GH3Q**

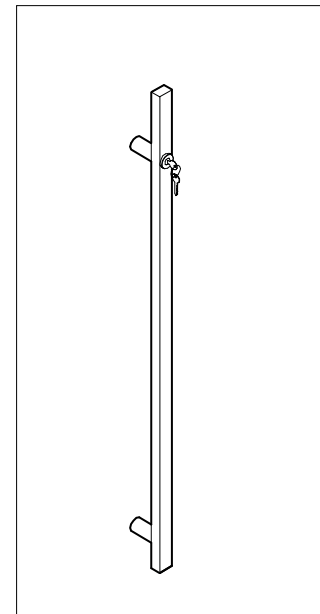

**MPOM3Q**

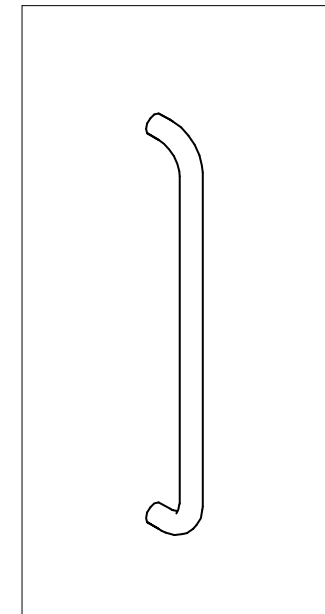

**MPOM8**

ALLUMINIO

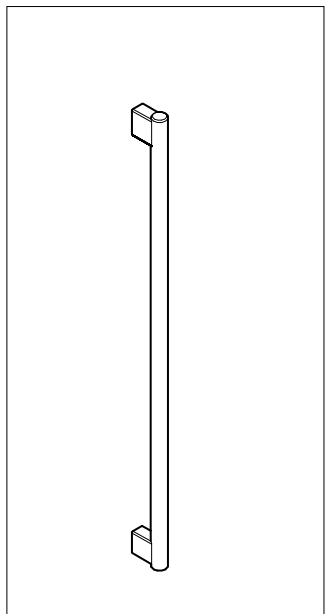

**MPOMTH1\_TH2**

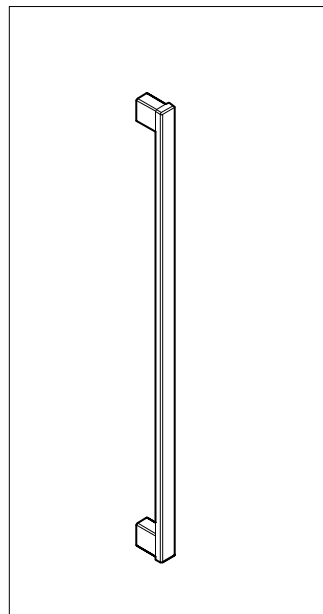

**MPOMQH1\_QH2**

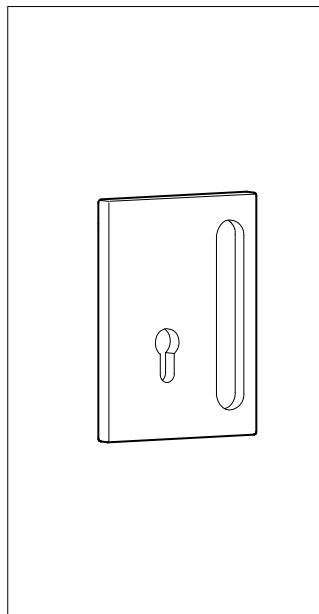

**MPOM6**

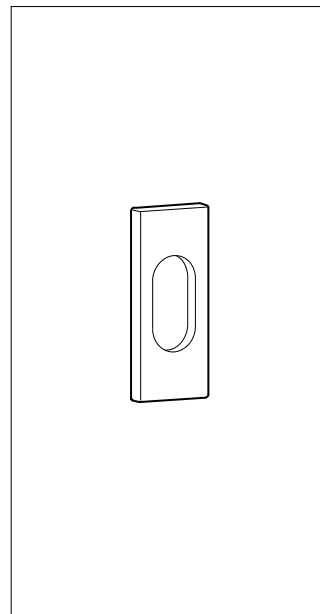

**MPOM7**

# Porte cieche



ACCIAIO

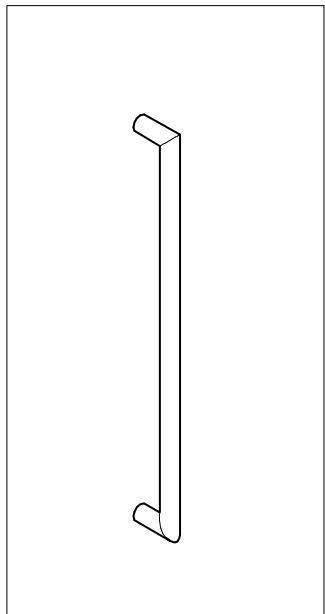

**MPOMGH1\_H2\_H3**

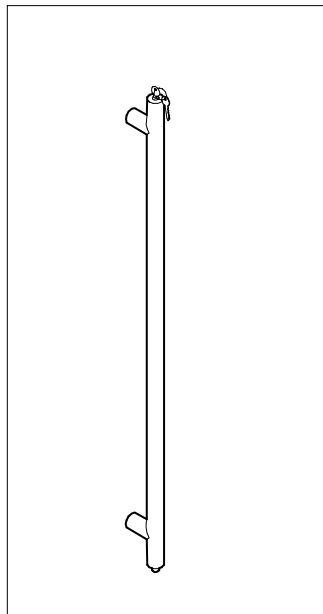

**MPOM2**

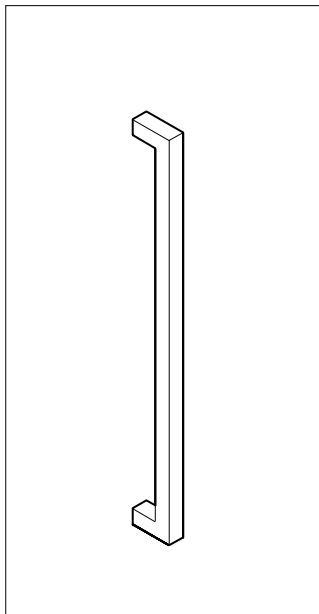

**MPOMGH1Q\_GH2Q\_GH3Q**

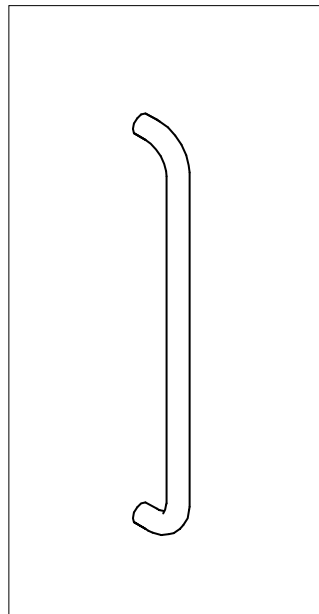

**MPOM8**

ALLUMINIO

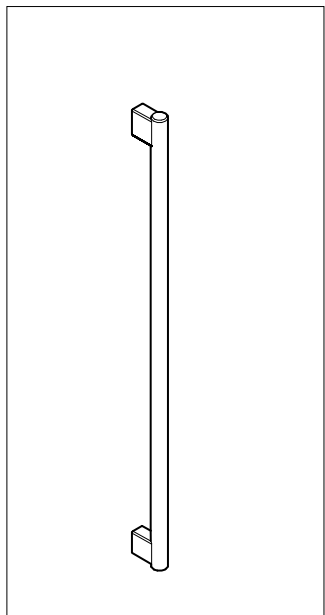

**MPOMTH1\_TH2**

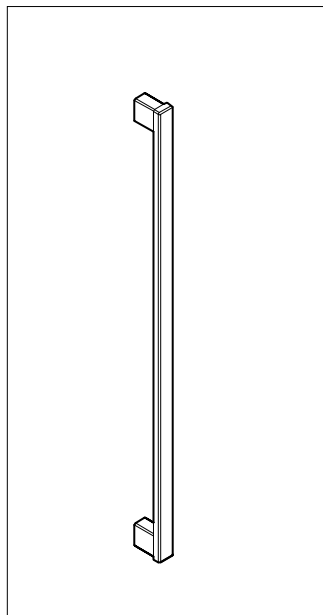

**MPOMQH1\_QH2**

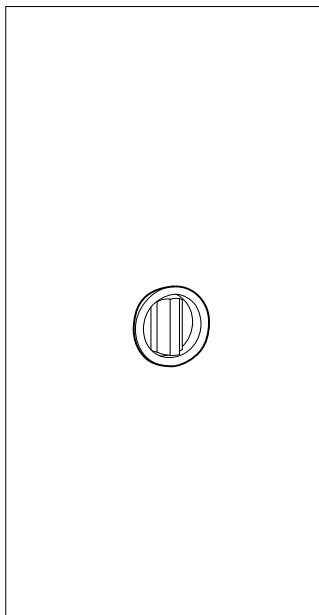

**MPOM4**

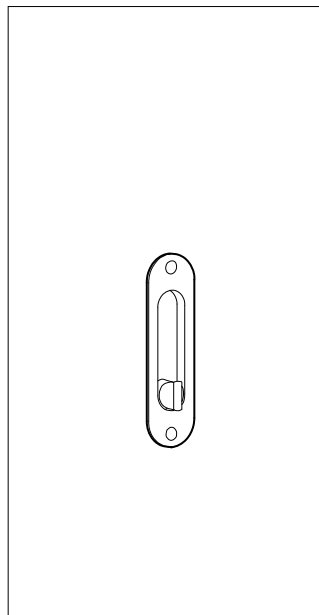

**MPOM5**

**METRICA<sup>®</sup>**  
STRUTTURALE

Accessori

---



## Chiudiporta aerei

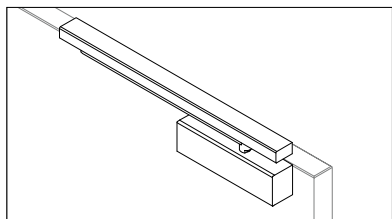

**01 esterno a slitta**  
*per anta cieca/intelaiata*

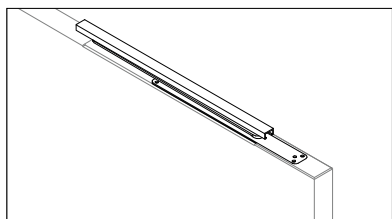

**02 a scomparsa**  
*per anta cieca/intelaiata*

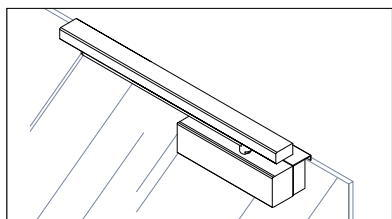

**03 esterno a slitta con supporto**  
*per anta in vetro temperato*

## Chiudiporta a terra

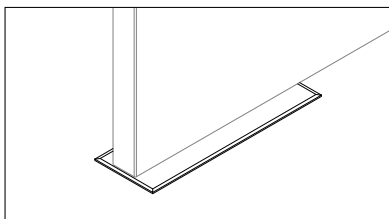

**01 a pavimento**  
*per anta cieca*

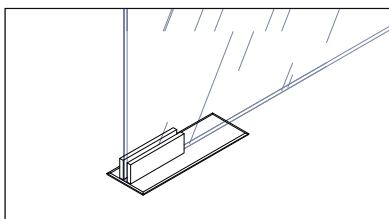

**02 a pavimento**  
*per anta in vetro temperato*

## Cerniere in alluminio

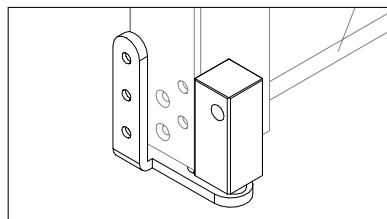

**01 a bilico esterno**  
*per anta cieca/intelaiata*

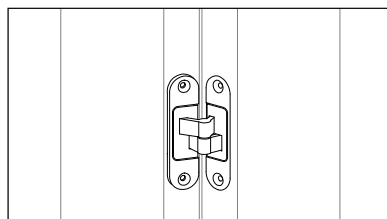

**02 a scomparsa**  
*per anta cieca/intelaiata*

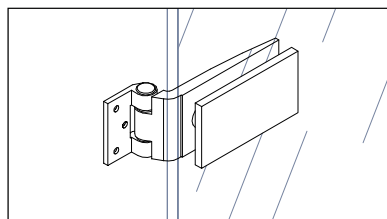

**03 apertura 180°**  
*per anta in vetro temperato*

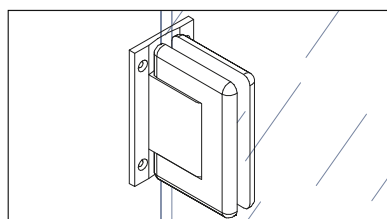

**04 va e vieni velocità regolabile**  
*per anta in vetro temperato*

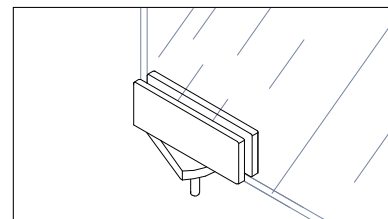

**05 va e vieni velocità regolabile**  
*per anta in vetro temperato*

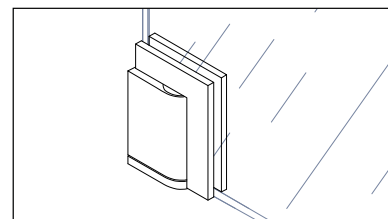

**06 va e vieni velocità regolabile**  
*per anta in vetro temperato*

## Accessori

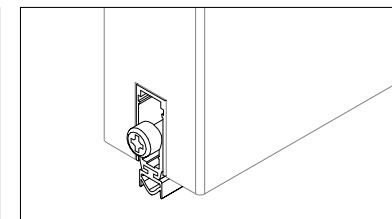

**01 Antispiffero insonorizzante**  
*per anta cieca/intelaiata*

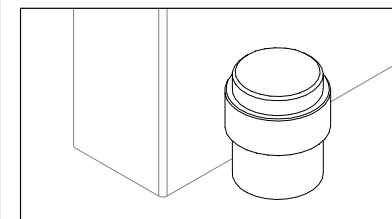

**02 Fermaporte**  
*per anta cieca/intelaiata/temperato*

**METRICA**<sup>®</sup>  
STRUTTURALE

Finiture

---



## Anodizzati

## Finiture RAL

## Lucidatura

## Legni



01 Alluminio naturale



01 Bianco



01 Brillantato



01 Rovere chiaro



02 Bronzo

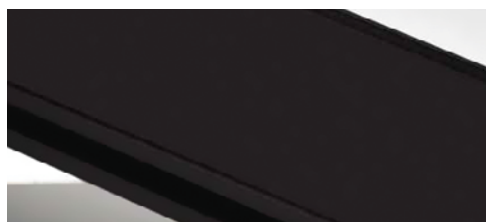

02 Nero

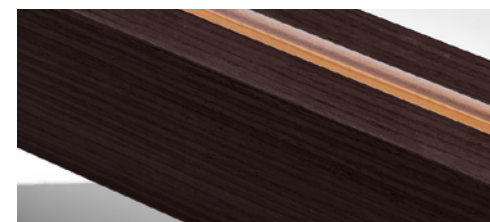

02 Rovere scuro

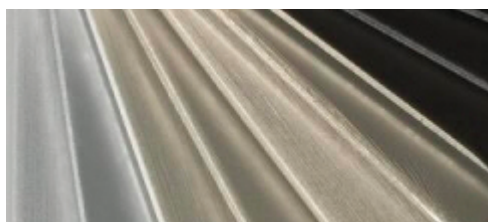

03 Colore a campione



03 Colore a campione



# Pannelli ciechi



CAT. 1

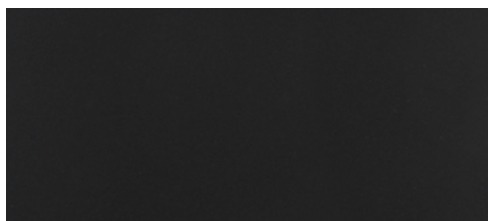

**055** Nero grafite

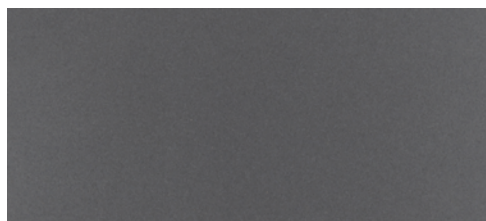

**420** Piombo



**418** Grigio cenere

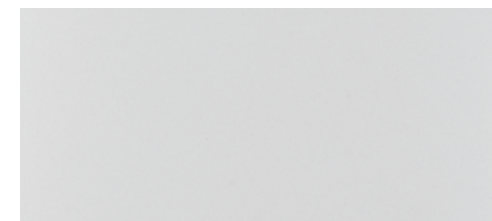

**419** Grigio chiaro

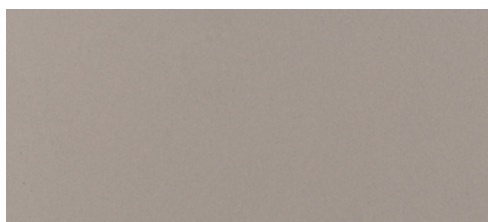

**393** Tortora



**417** Vaniglia

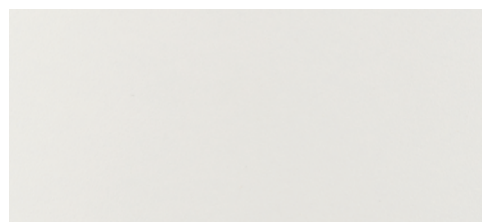

**429** Bianco caldo

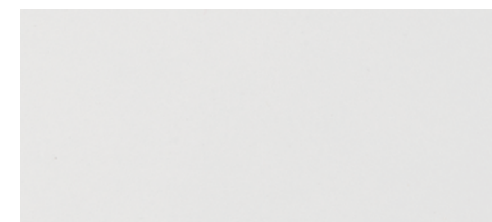

**428** Bianco freddo

CAT. 2



**422** Argento

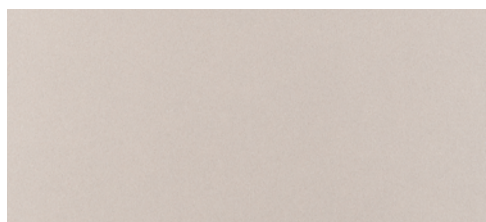

**423** Champagne

# Legni



CAT. 1

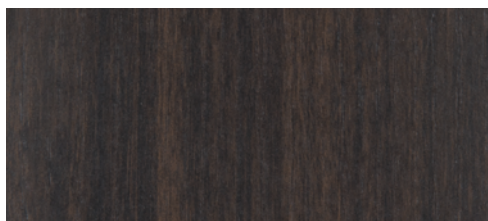

**421** Eucalipto

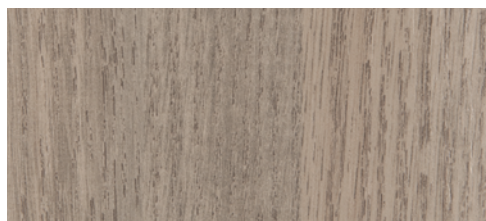

**426** Rovere medio



**274** Acacia



**416** Bianco venato

CAT. 2

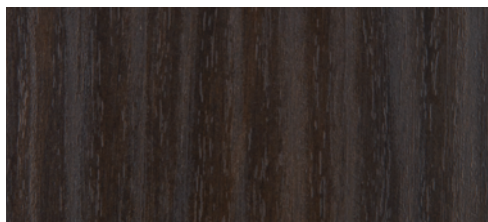

**425** Noce scuro

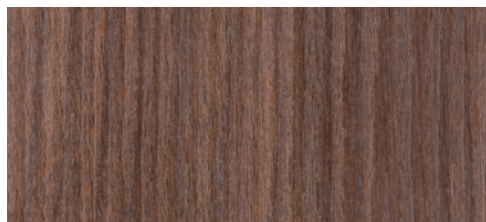

**318** Noce medio

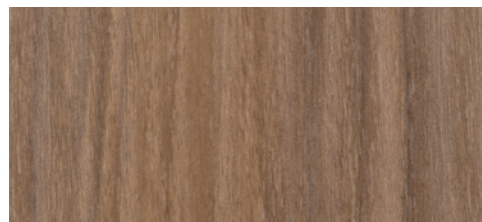

**427** Noce chiaro

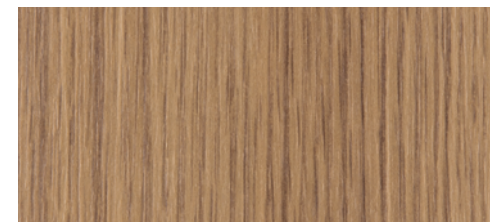

**382** Rovere naturale

CAT. 3



**138** Rovere invecchiato - taglio seta

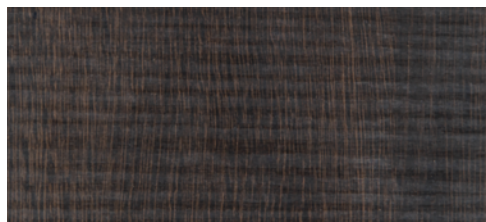

**197** Eucalipto - taglio seta

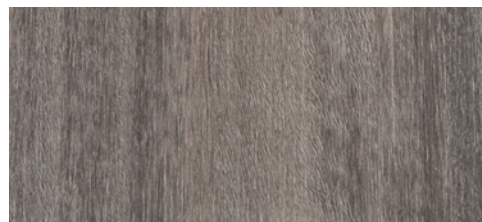

**408** Rovere grigio

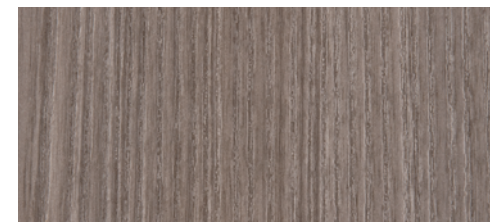

**400** Rovere Danubio

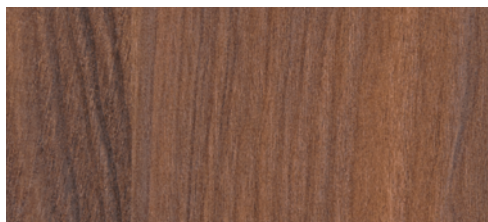

**414** Noce rosso

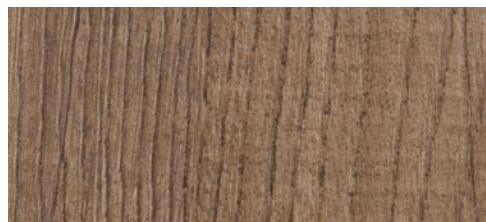

**412** Rovere vintage



**413** Rovere champagne



**410** Rovere chiaro



# Materici



CAT. 2

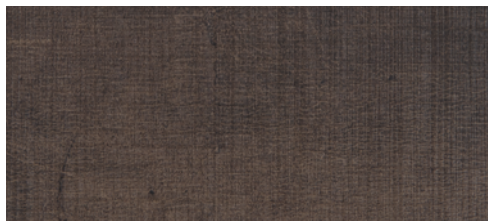

**304** Tessuto scuro



**123** Tessuto medio

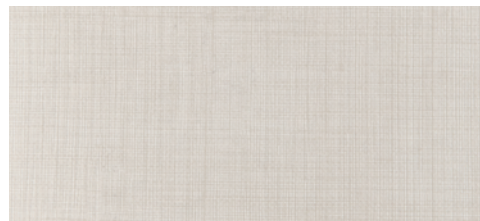

**305** Tessuto chiaro



**424** Ossido

CAT. 3

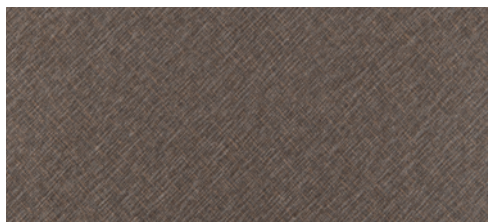

**385** Lino bronzo

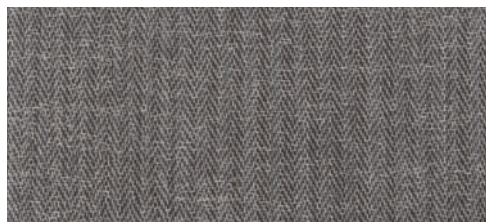

**409** Corteccia

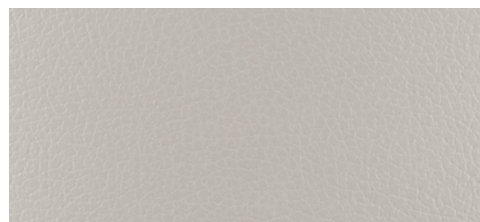

**406** Primo fiore grigio

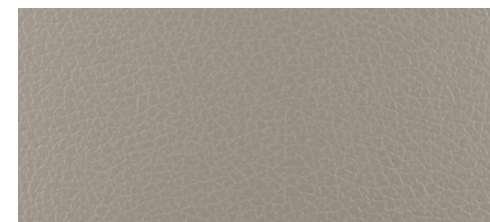

**405** Primo fiore tortora



**404** Primo fiore beige

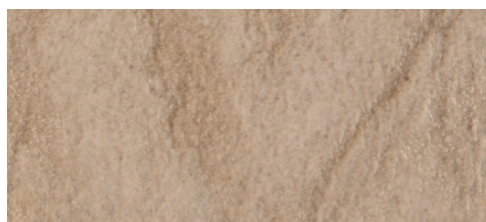

**415** Deserto

# Vetri



**01** Trasparente



**03** Satinato

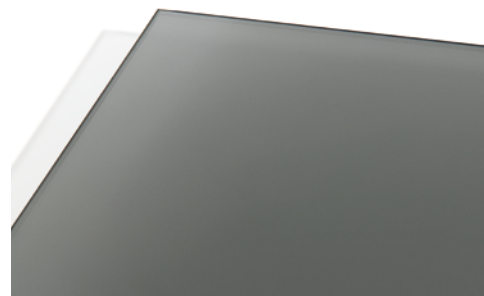

**05** Fumé



**02** Extrachiaro

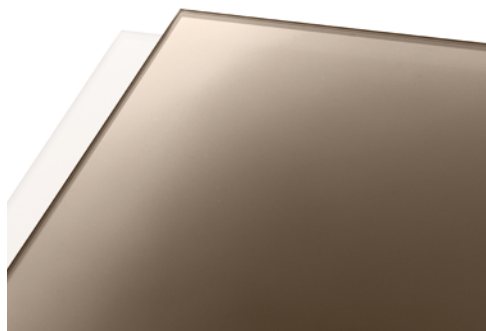

**04** Bronzo



**06** Verniciato a campione



**Etoile s.r.l. - Società Unipersonale**

Via D. Albertario, 50 61032 Zona Ind.le Bellocchi - Fano ( PU ) Italy  
P. +39.0721.85.59.34 - F. +39.0721.85.92.14  
[info@etoilesrl.it](mailto:info@etoilesrl.it) - [www.etoilesrl.it](http://www.etoilesrl.it)