



☐ ETOILE

METRICA[®]
STRUTTURALE



Metrica è un sistema di pareti interne
mobili attrezzate con struttura portante,
fornita in **quattro soluzioni** formalmente **diverse.**



METRICA® R
profilo squadrato

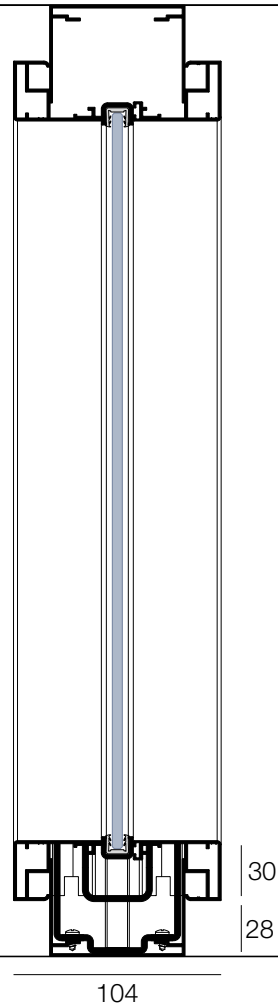

METRICA® V
doppio vetro "intelaiato"

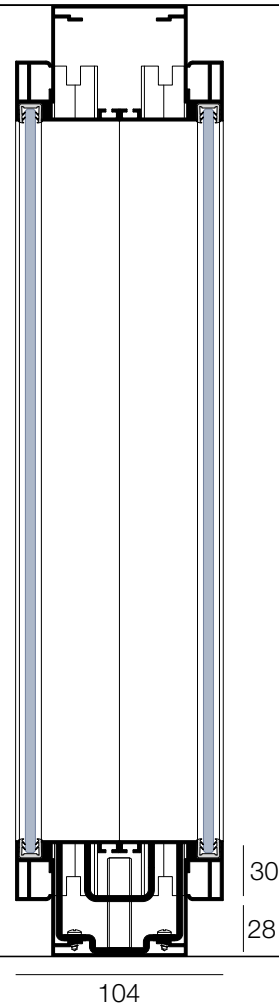

METRICA® S
doppio vetro a filo esterno

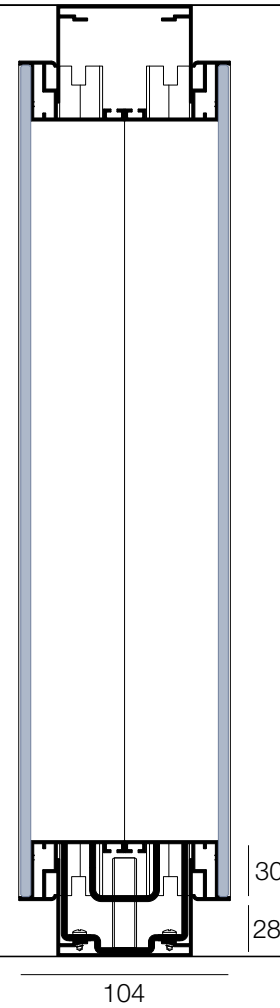

METRICA® SOLID
doppi pannelli ciechi 18 mm

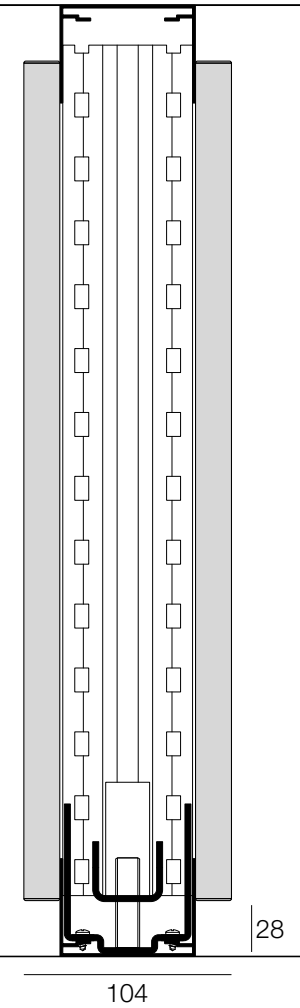

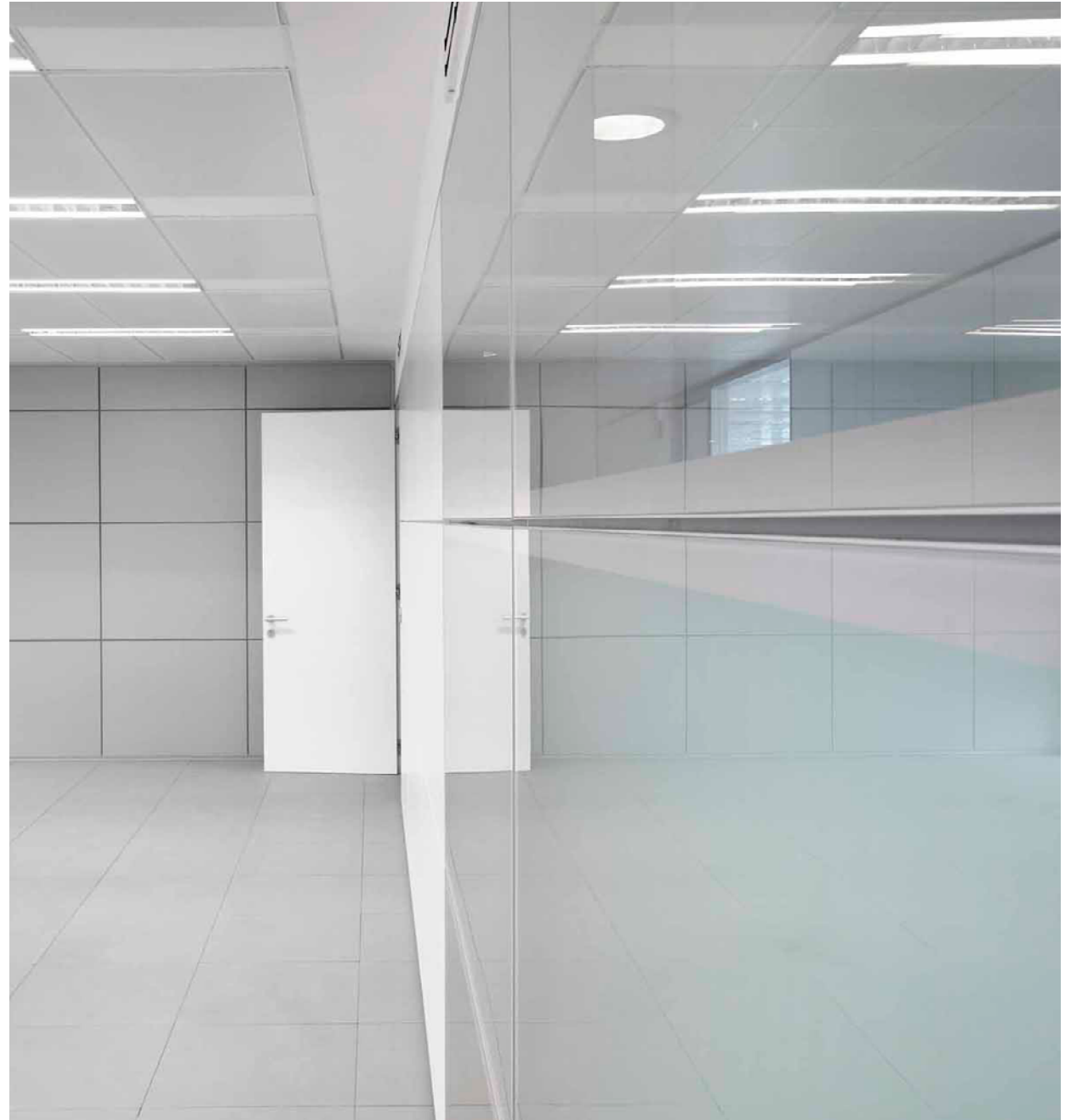
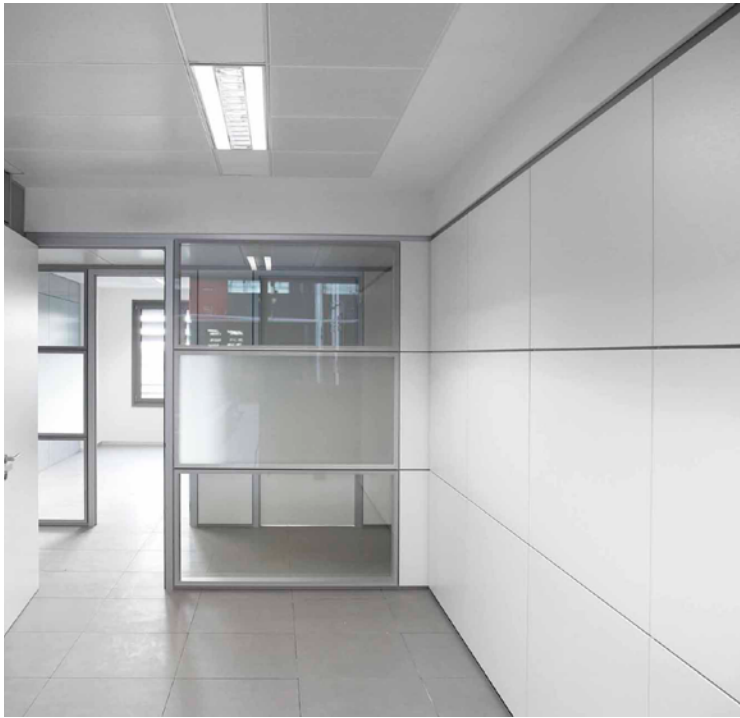



CARATTERISTICHE

- 01.** Spessore 104 mm
- 02.** Struttura portante in lamiera zincata UNI EN 10143
- 03.** Parete a pannelli verticali e fasce orizzontali
- 04.** Pannelli a passo 500/1000/1500/2000 mm
- 05.** Cremagliera a passo 32 per il fissaggio dei pannelli
- 06.** 3 versioni di pareti in vetro - vetro singolo centrale, doppio intelaiato e doppio a filo esterno con perimetro serigrafato
- 07.** 1 parete cieca realizzata in pannelli nobilitati - spessore 18 mm
- 08.** 2 spessori di vetri di sicurezza o acustici impiegabili
- 09.** Profili d'angolo fissi e variabili - connessioni 2/3/4 vie
- 10.** Telaio porta cablabile
- 11.** Modulo tecnico ispezionabile
- 12.** 11 versioni di porte battenti - cieche, in vetro temperato e intelaiate
- 13.** 2 versioni di porte scorrevoli interne - cieche e in vetro temperato
- 14.** 5 versioni di porte scorrevoli esterne - cieche, in vetro temperato e intelaiate

METRICA[®] R





- 01.** Spessore 104 mm
- 02.** Struttura portante in lamiera zincata UNI EN 10143
- 03.** Parete a pannelli verticali e fasce orizzontali
- 04.** Pannelli a passo 500/1000/1500/2000 mm
- 05.** Vetro singolo centrale - spessore 33.1 o 5 mm
- 06.** Profili d'angolo fissi e variabili - connessioni 2/3/4 vie
- 07.** Telaio porta cablabile
- 08.** Modulo tecnico ispezionabile
- 09.** 11 versioni di porte battenti - cieche, in vetro temperato e intelaiate
- 10.** 5 versioni di porte scorrevoli esterne - cieche, in vetro temperato e intelaiate

- 01.** Vetro verticale 33.1 - **33 dB**
- 02.** Vetro orizzontale 33.1 - da **25 dB** a **36 dB**
- 03.** Vetro verticale 33.1 + pannello cieco da **30 dB** a **38 dB**



Partenze

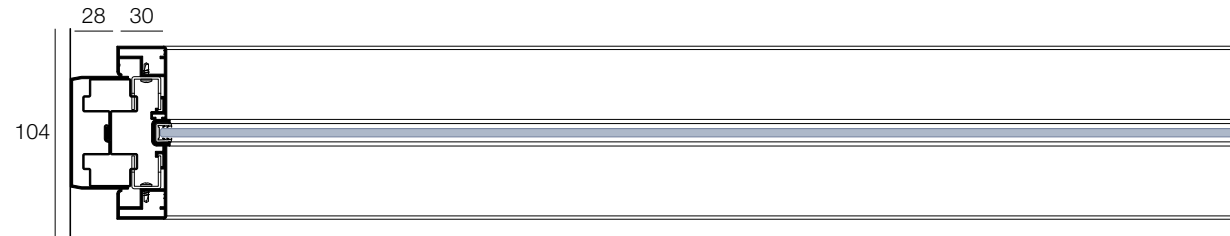
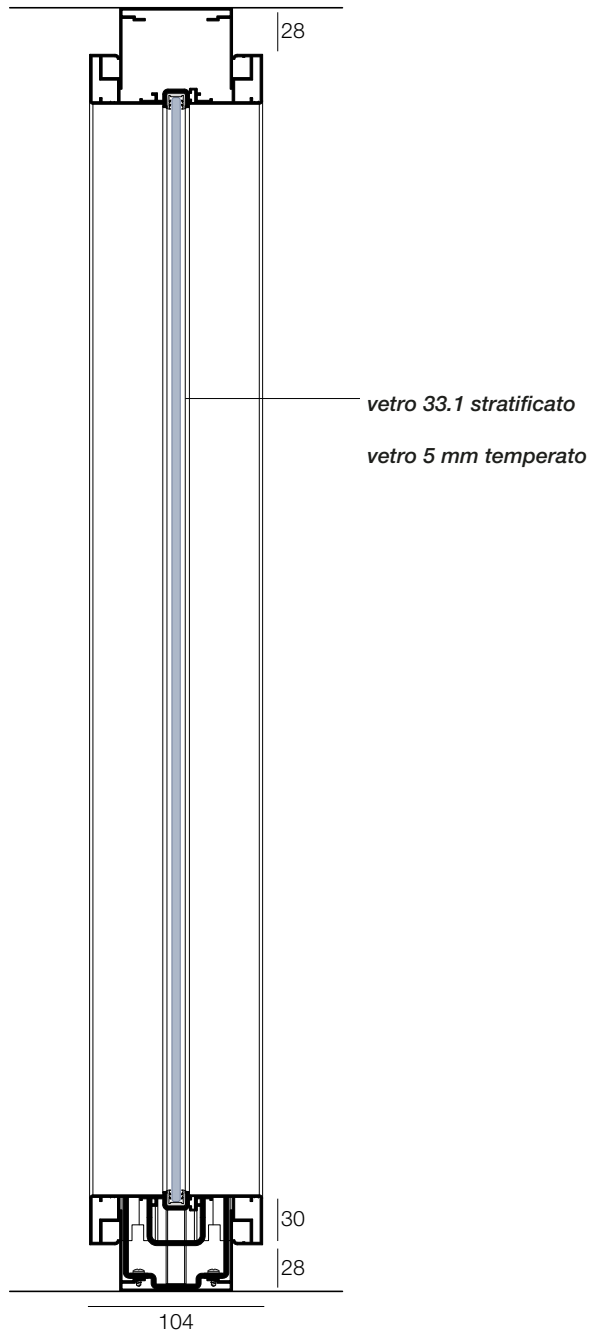

Partenza telescopica

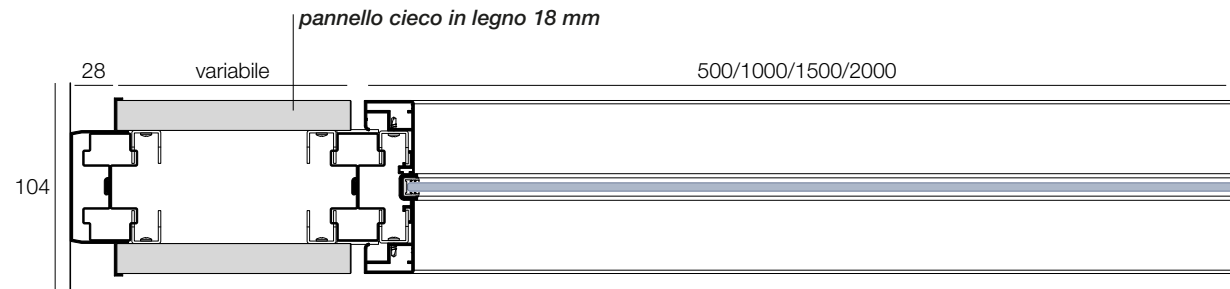

Partenza da tamponamento

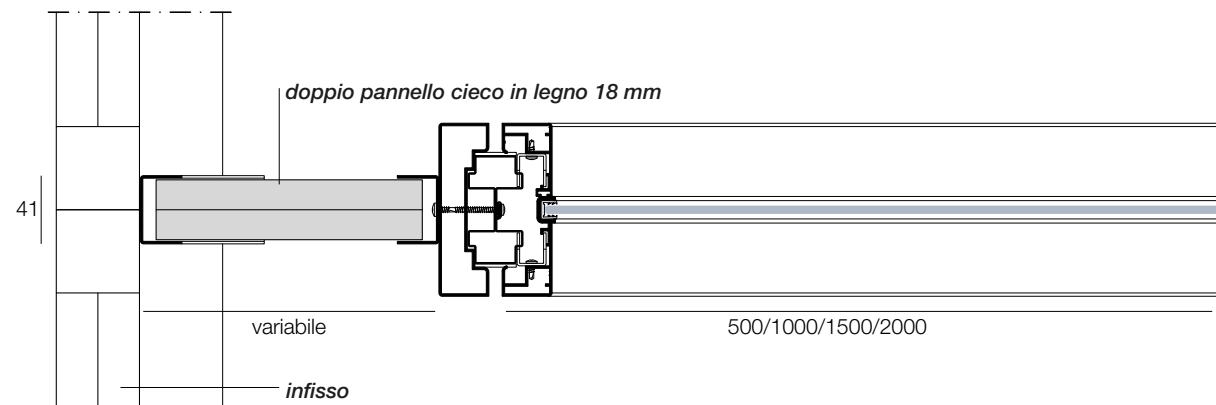

Partenza da parete

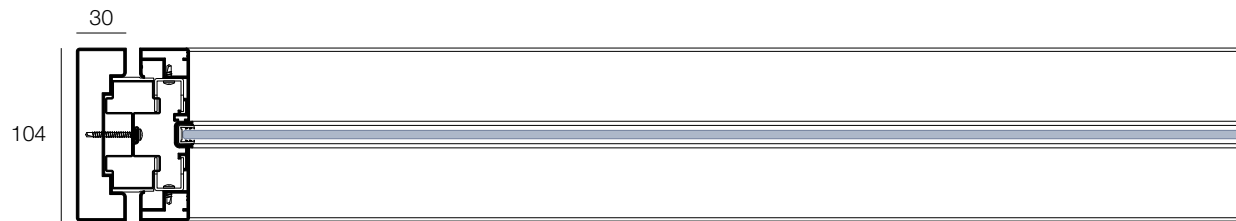

Profilo terminale

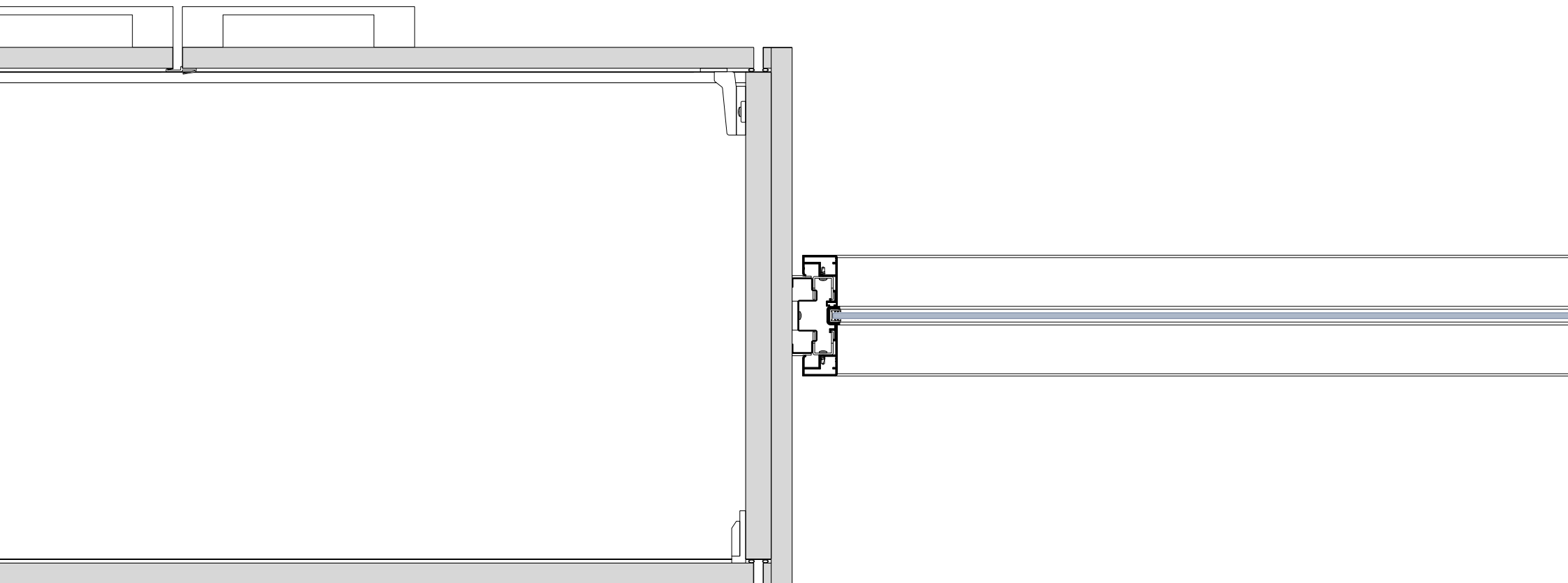

Partenza da contenitore

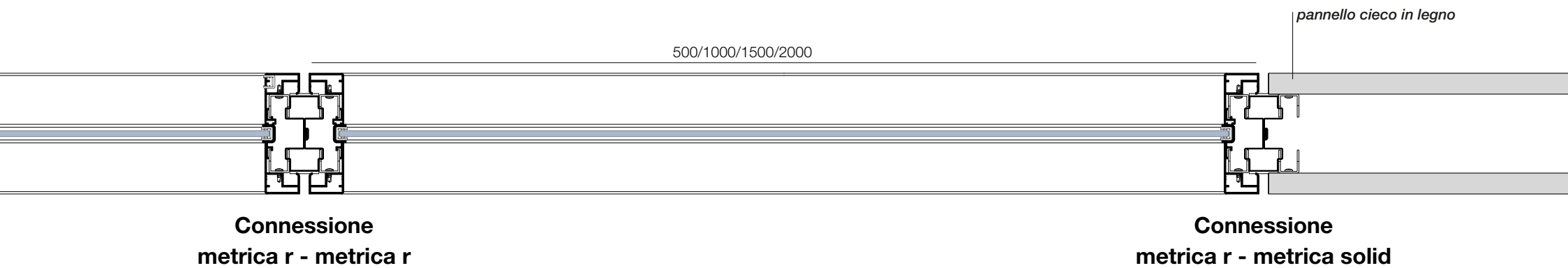

Angoli

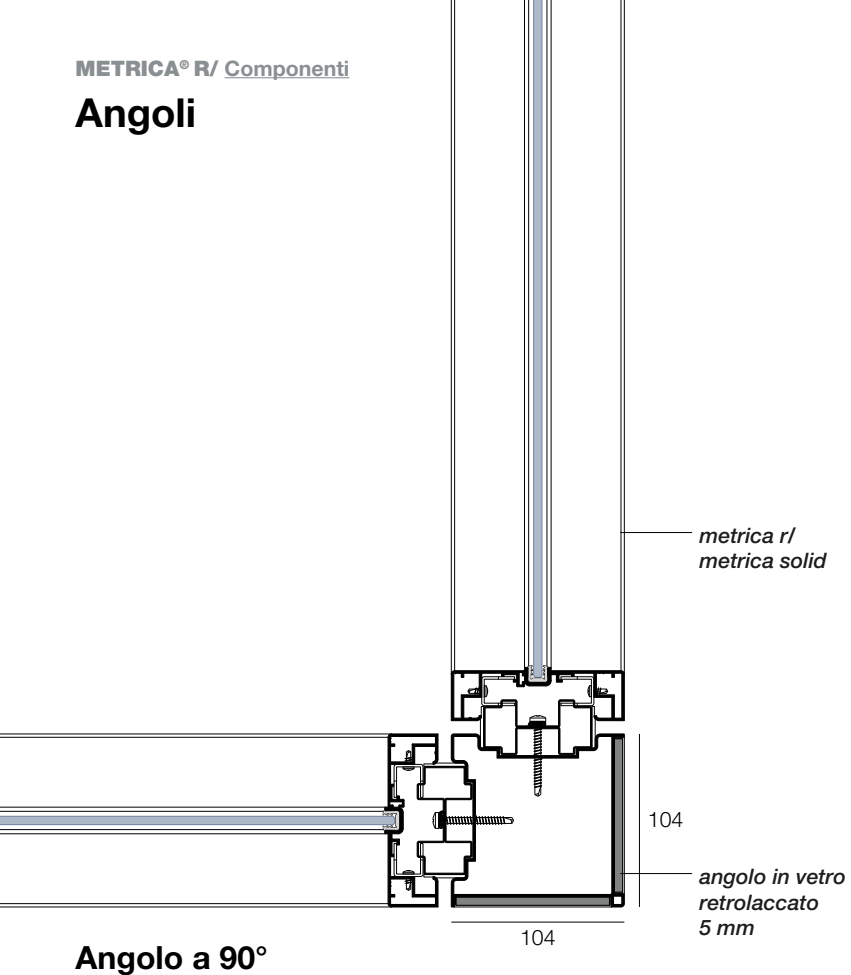

Angolo a 90°

Angolo 2 vie

Angolo variabile



Angolo 3 vie

Angolo 4 vie

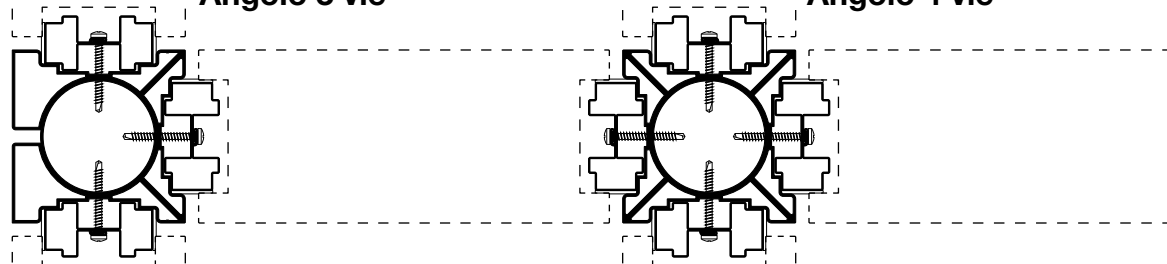

Cablaggio e modulo tecnico della porta a battente



Modulo tecnico

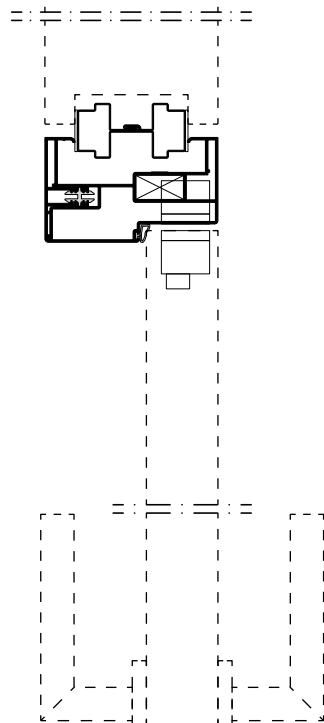
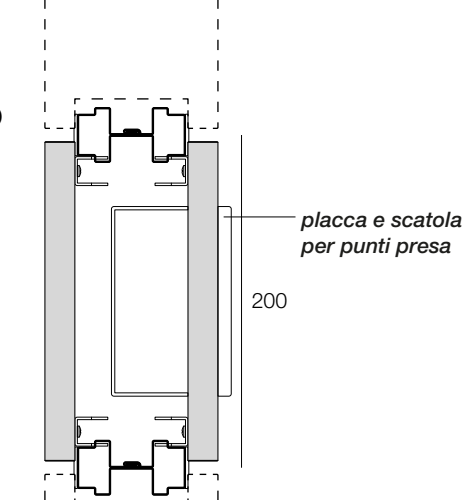

Soluzione di cablaggio

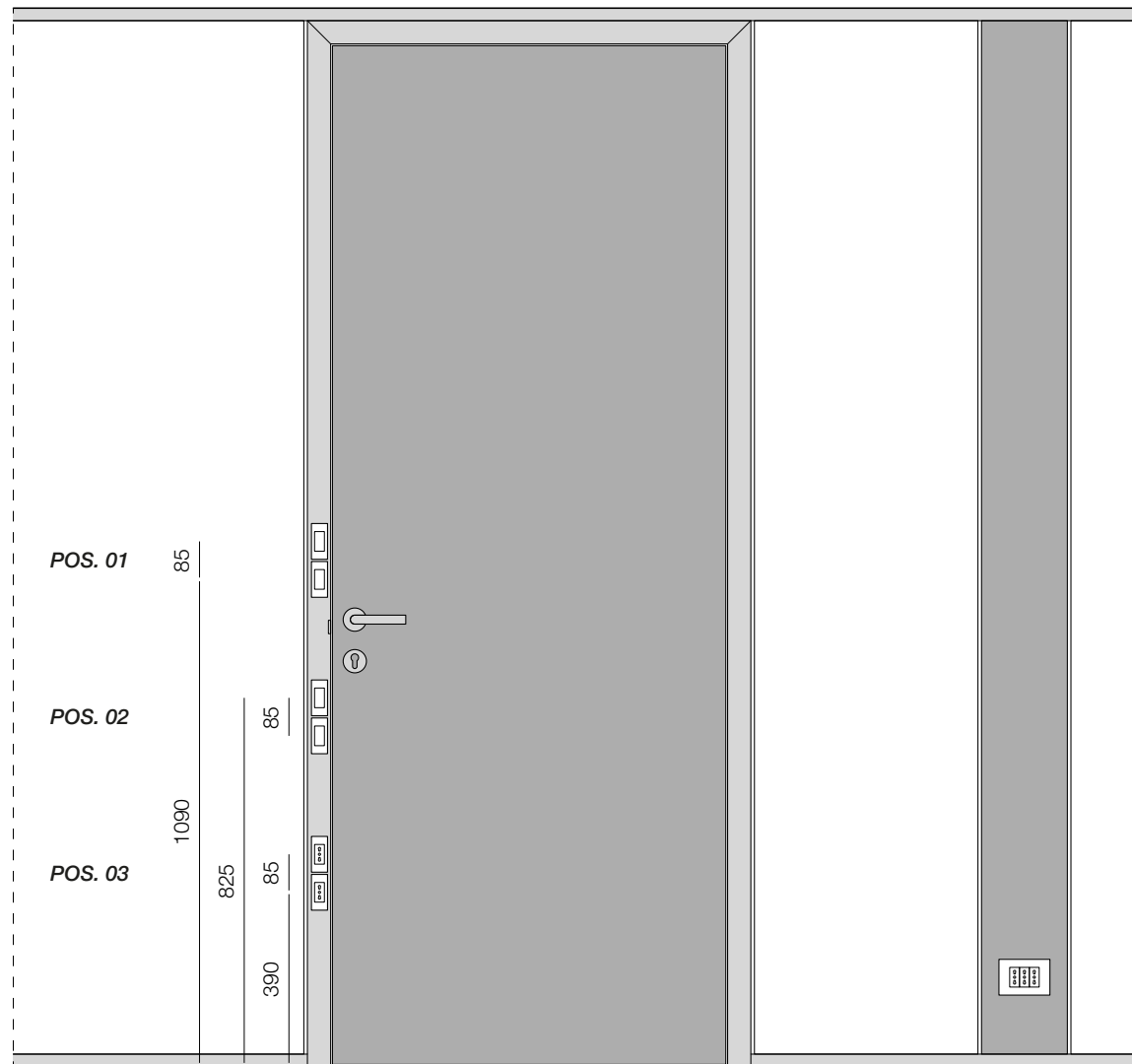
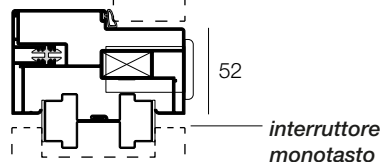

*posizioni possibili di interruttori e prese su telaio porta

Modulo tecnico della porta scorrevole



Modulo tecnico

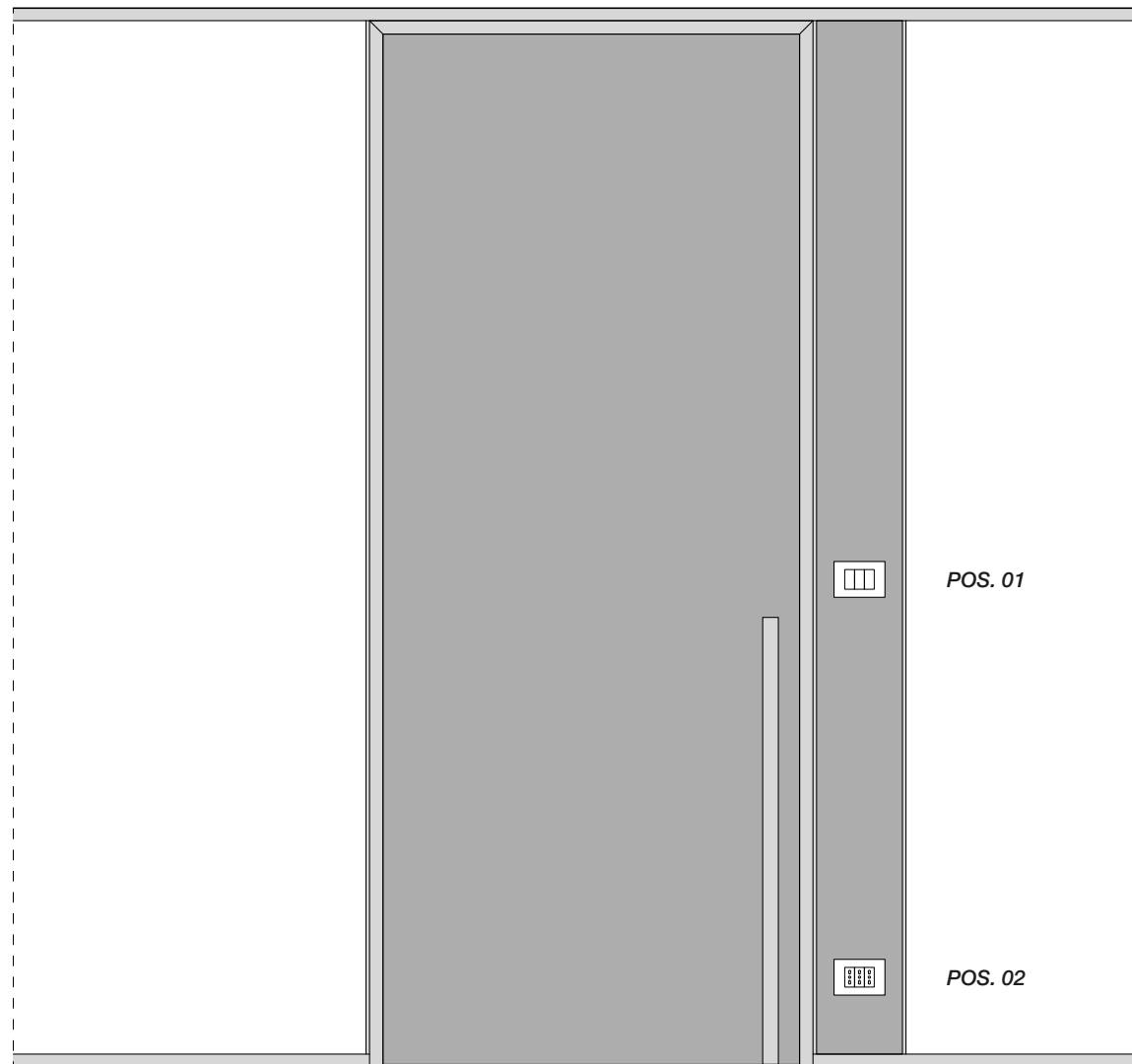
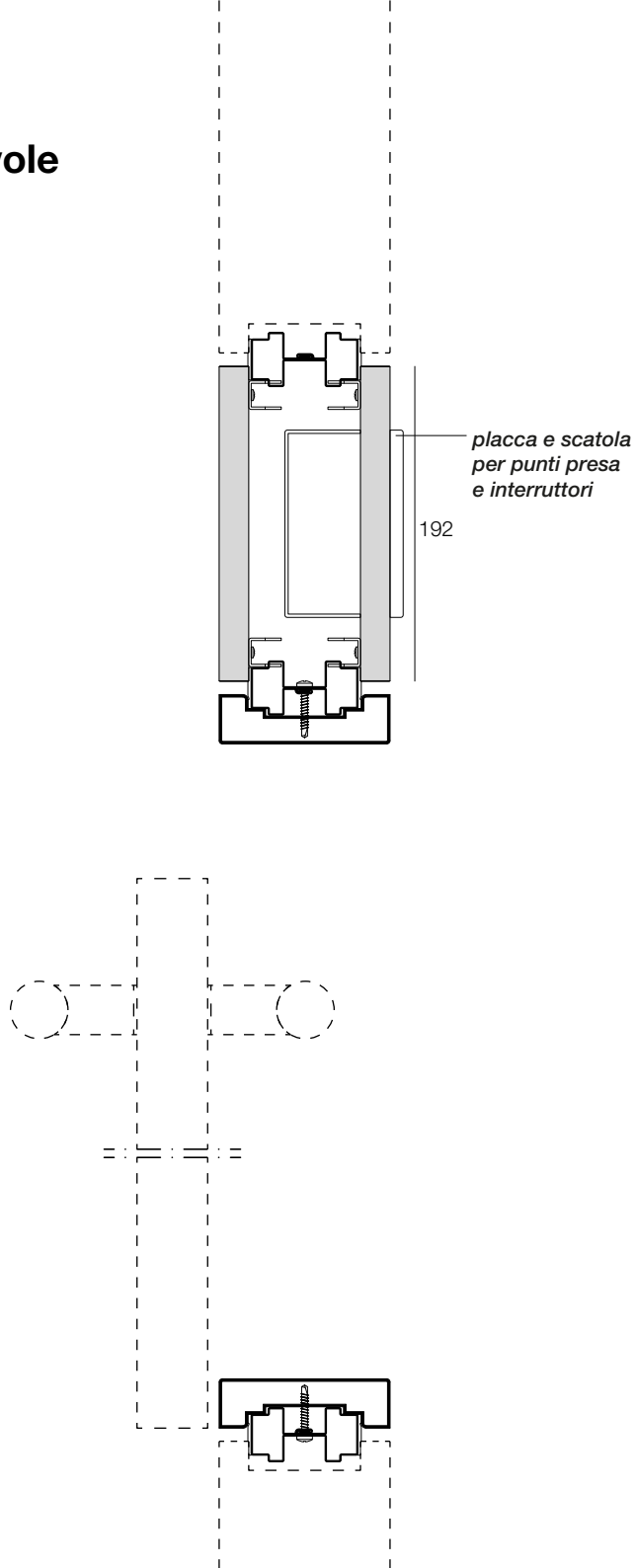

*posizioni possibili di interruttori e prese su modulo tecnico

METRICA® V





- 01.** Spessore 104 mm
- 02.** Struttura portante in lamiera zincata UNI EN 10143
- 03.** Parete a pannelli verticali e fasce orizzontali
- 04.** Pannelli a passo 500/1000/1500/2000 mm
- 05.** Doppio vetro intelaiato - spessore 33.1 o 5 mm
- 06.** Profili d'angolo fissi e variabili - connessioni 2/3/4 vie
- 07.** Telaio porta cablabile
- 08.** Modulo tecnico ispezionabile
- 09.** 11 versioni di porte battenti - cieche, in vetro temperato e intelaiate
- 10.** 5 versioni di porte scorrevoli esterne - cieche, in vetro temperato e intelaiate

- 01.** Doppio vetro verticale 33.1 - **42 dB**
- 02.** Doppio vetro orizzontale 33.1 - **40 dB**
- 03.** Doppio vetro verticale 33.1 + pannello cieco da **40 dB** a **46 dB**



Partenze

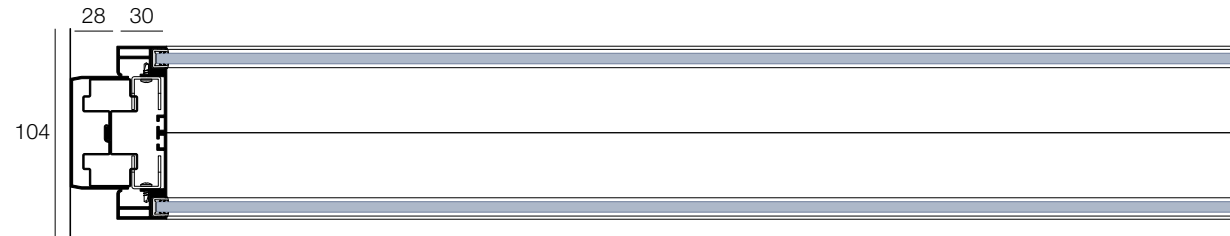
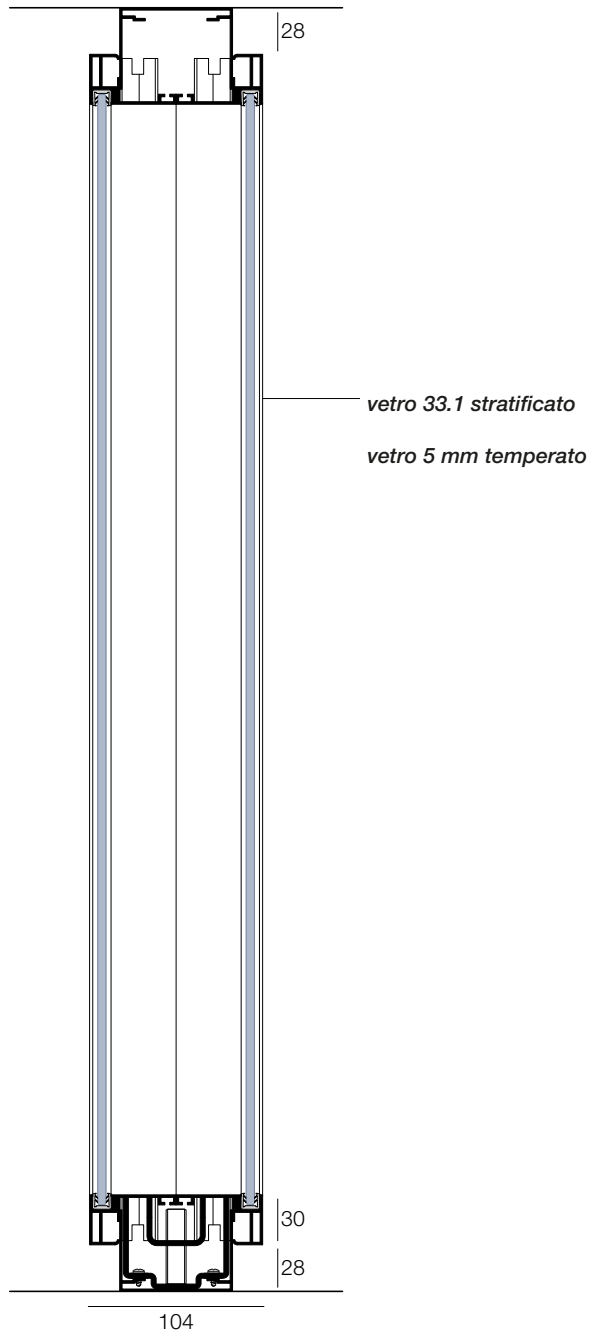

Partenza telescopica

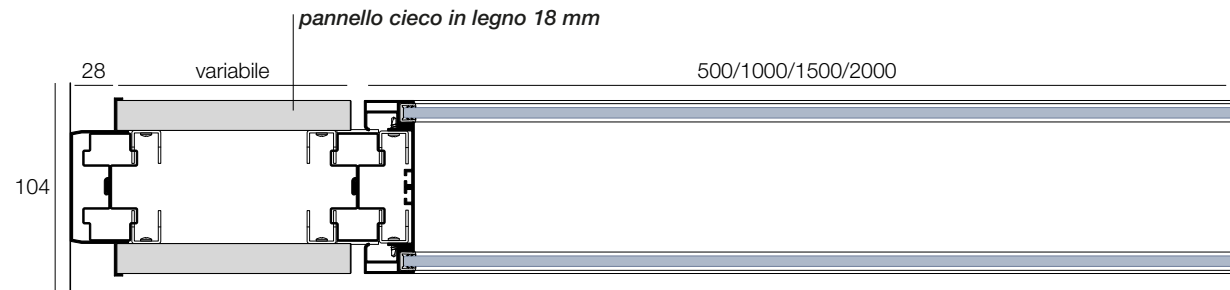

Partenza da tamponamento

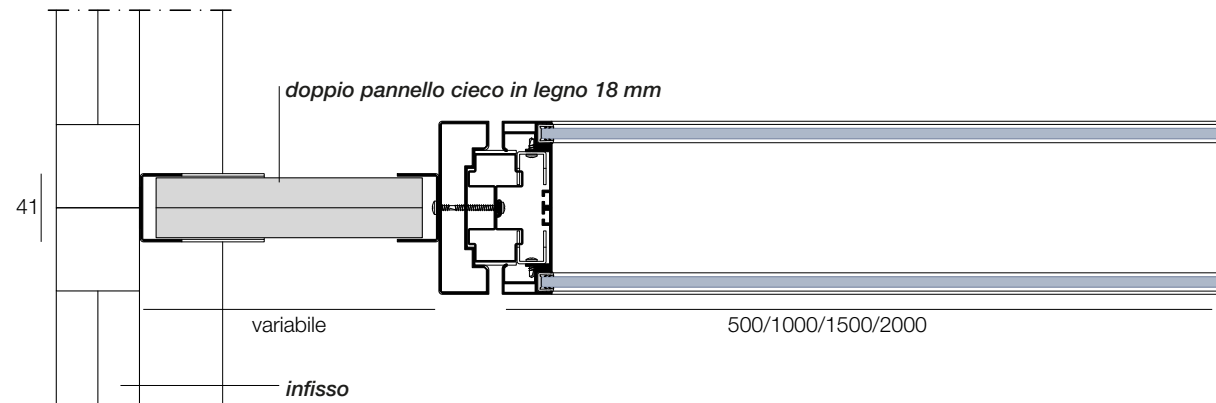

Partenza da parete

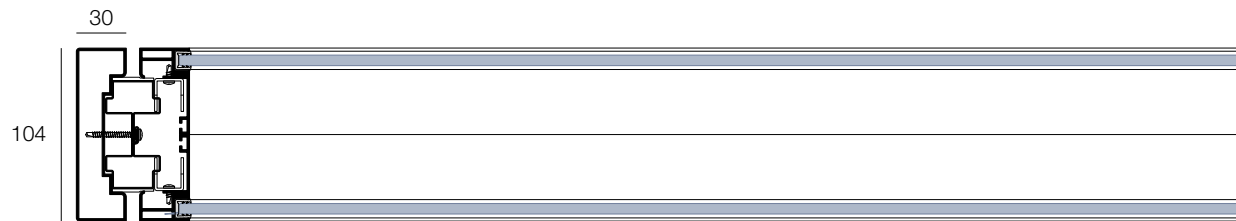

Profilo terminale

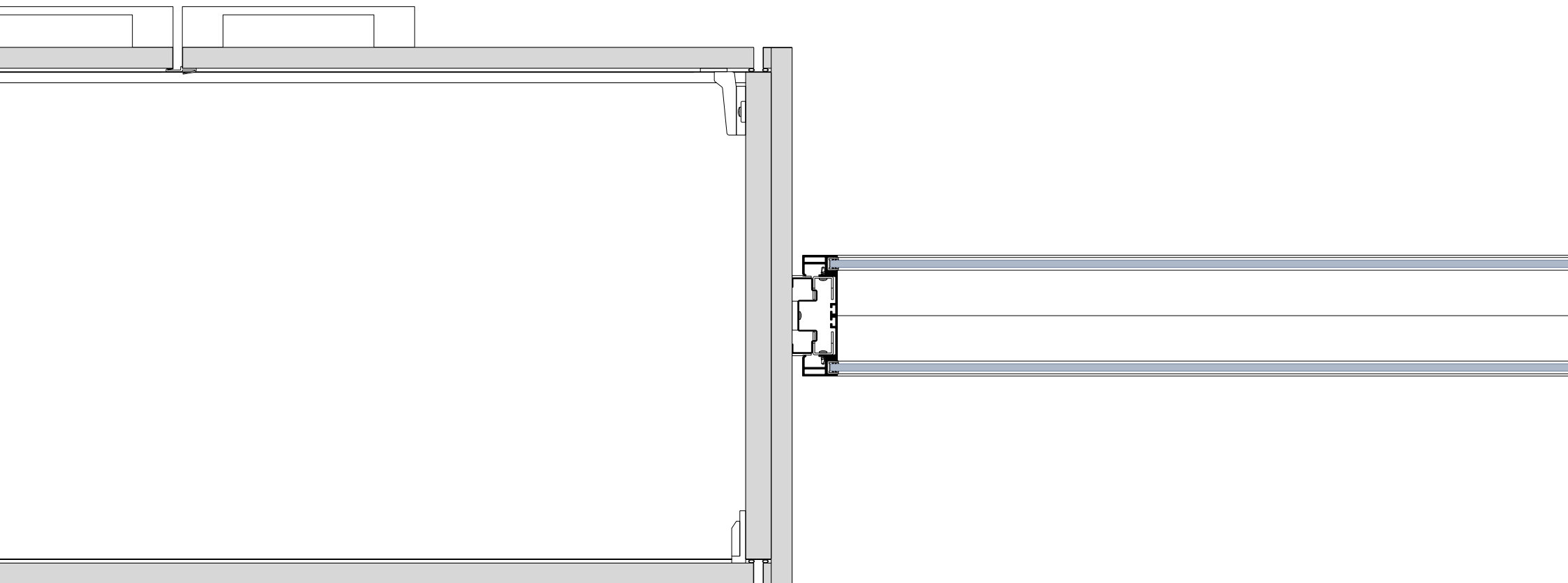

Partenza da contenitore

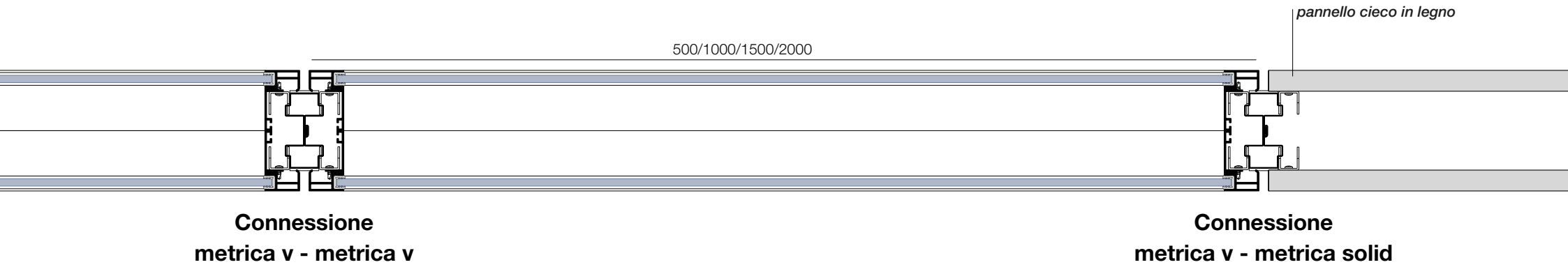

Angoli

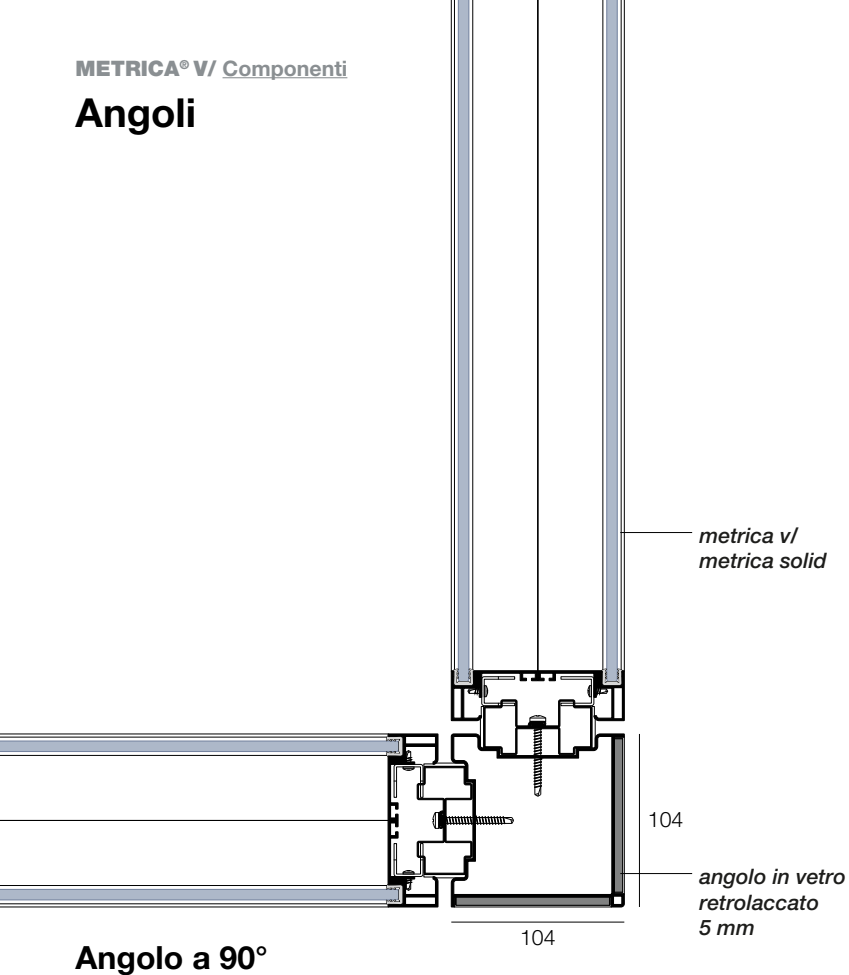

Angolo a 90°

Angolo 2 vie

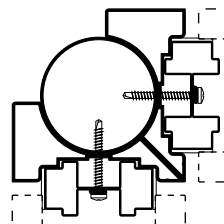

Angolo variabile

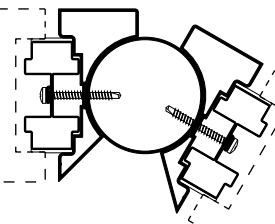

Angolo 3 vie

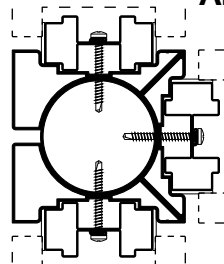

Angolo 4 vie

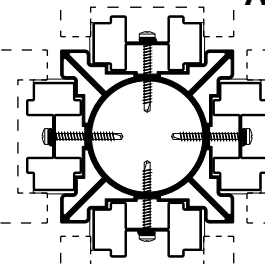

Cablaggio e modulo tecnico della porta a battente



Modulo tecnico

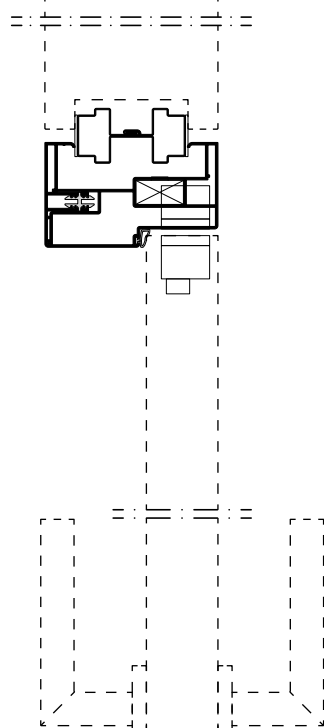
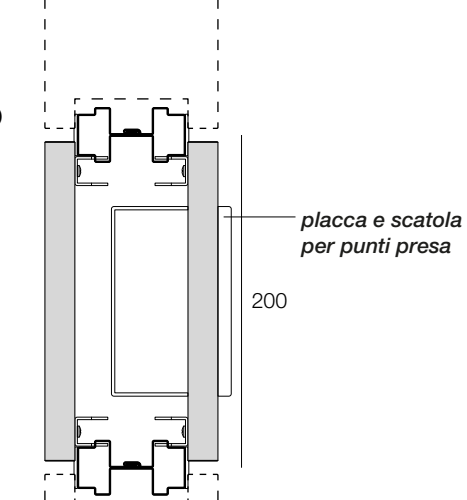

Soluzione di cablaggio

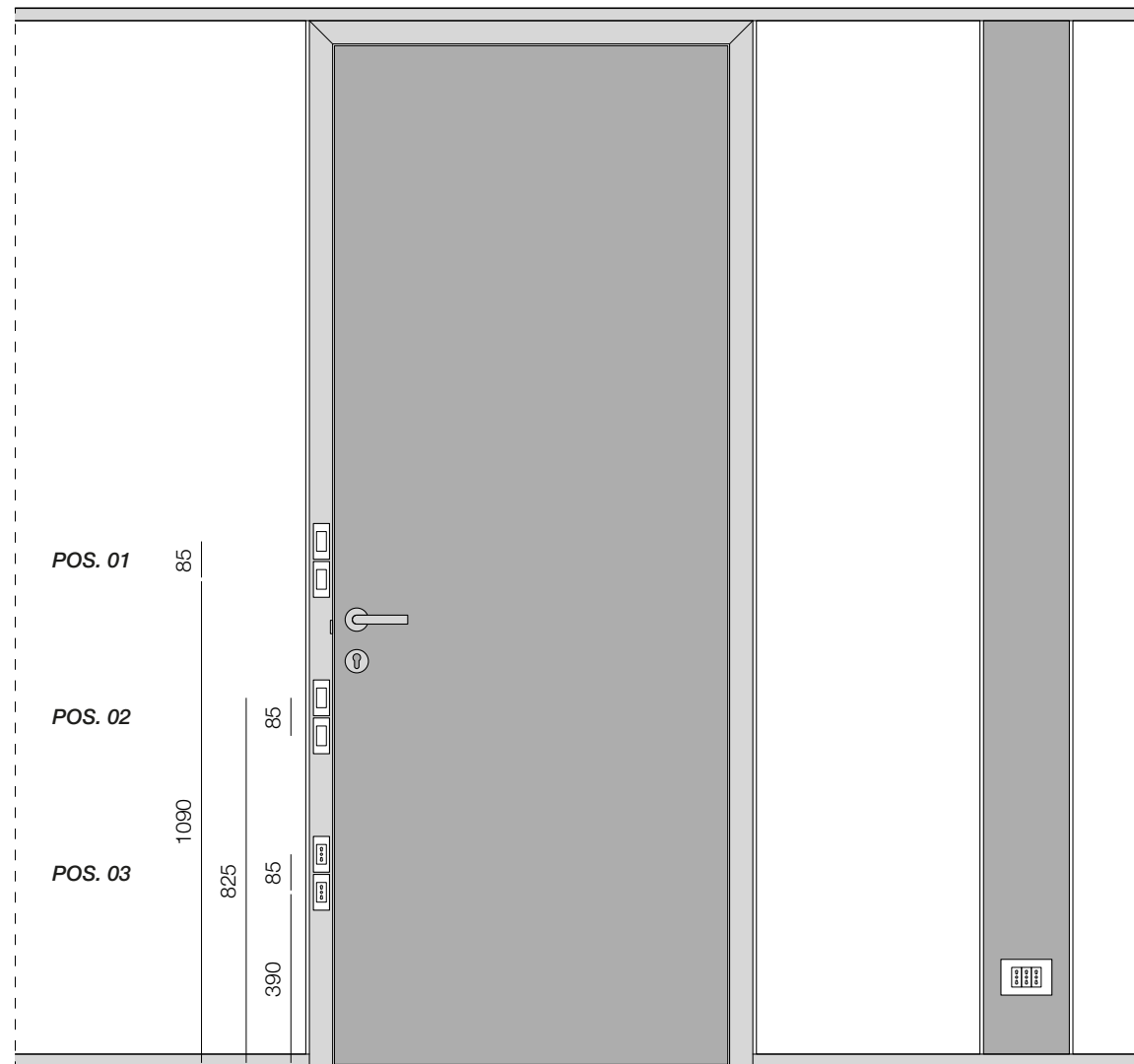
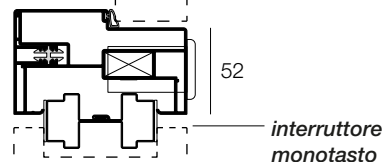

*posizioni possibili di interruttori e prese su telaio porta

Modulo tecnico della porta scorrevole



Modulo tecnico

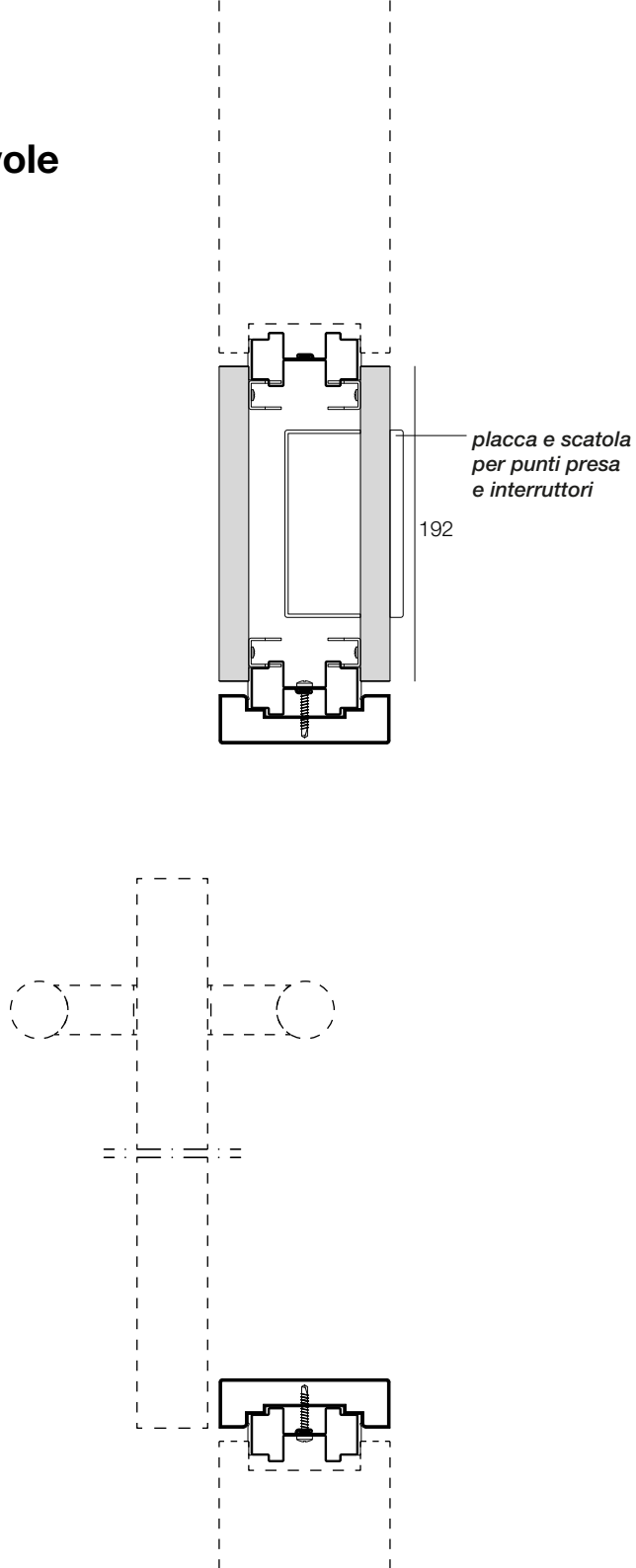

*posizioni possibili di interruttori e prese su modulo tecnico

METRICA[®] S





- 01.** Spessore 104 mm
- 02.** Struttura portante in lamiera zincata UNI EN 10143
- 03.** Parete a pannelli verticali e fasce orizzontali
- 04.** Pannelli a passo 500/1000/1500/2000 mm
- 05.** Doppio vetro a filo esterno con perimetro serigrafato - spessore 5 mm
- 06.** Profili d'angolo fissi e variabili - connessioni 2/3/4 vie
- 07.** Telaio porta cablabile
- 08.** Modulo tecnico ispezionabile
- 09.** 11 versioni di porte battenti - cieche, in vetro temperato e intelaiate
- 10.** 5 versioni di porte scorrevoli esterne - cieche, in vetro temperato e intelaiate

- 01.** Doppio vetro verticale 5 mm - **38 dB**
- 02.** Doppio vetro orizzontale 5 mm - **41 dB**
- 03.** Doppio vetro verticale 5 mm + pannello cieco da **39 dB** a **44 dB**

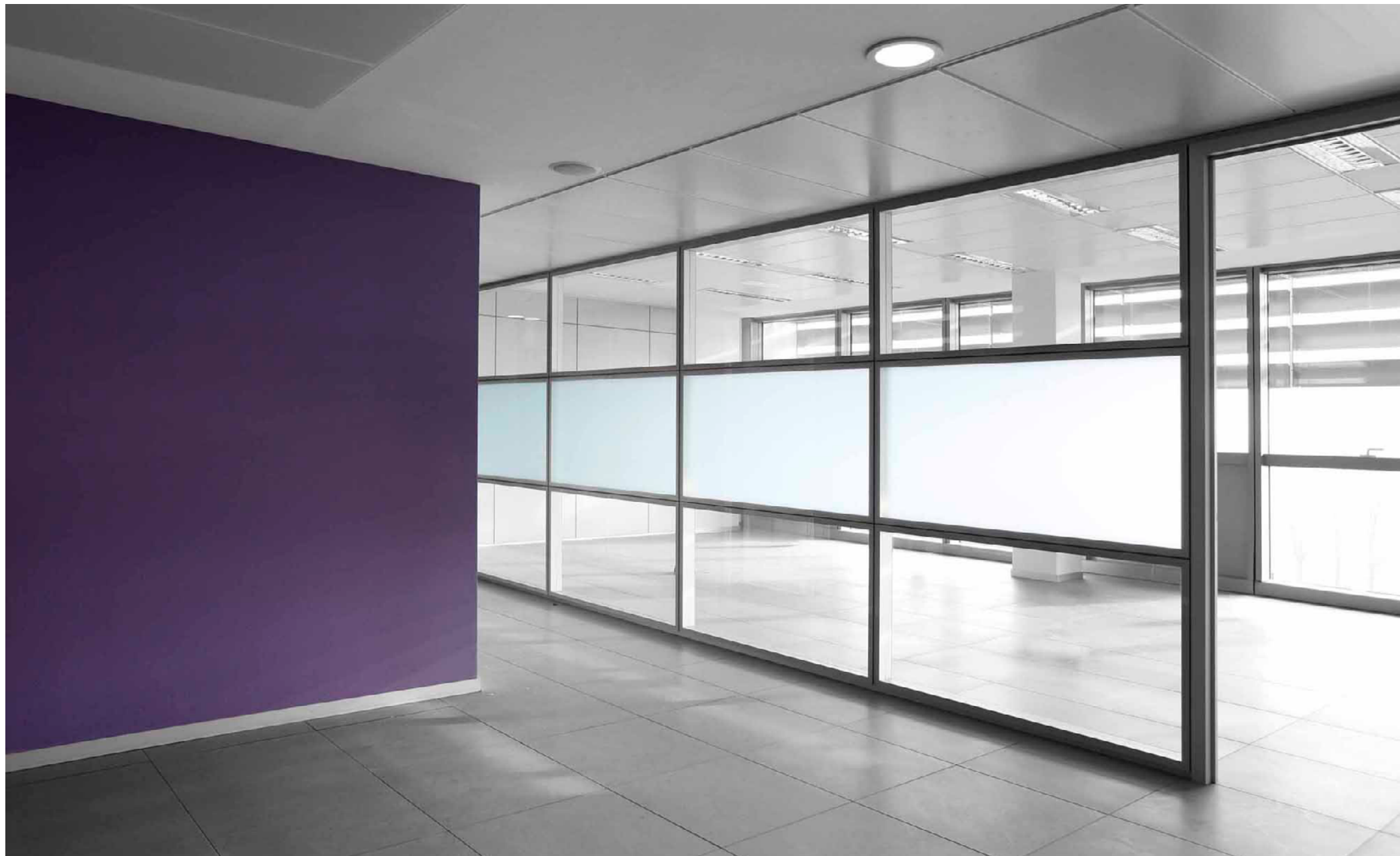

Partenze

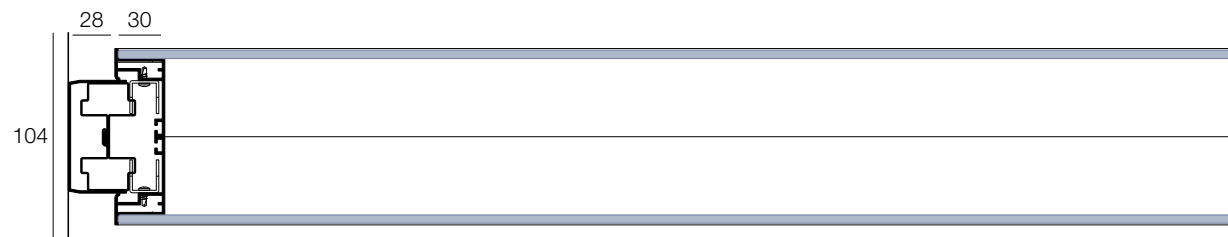
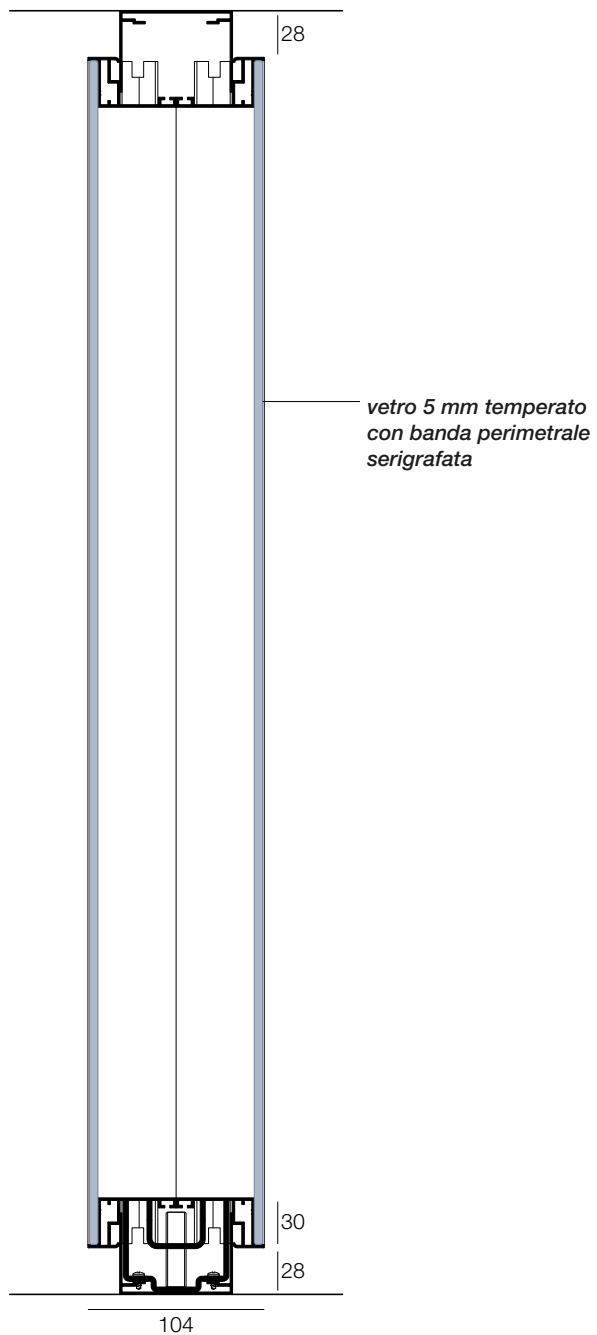

Partenza telescopica

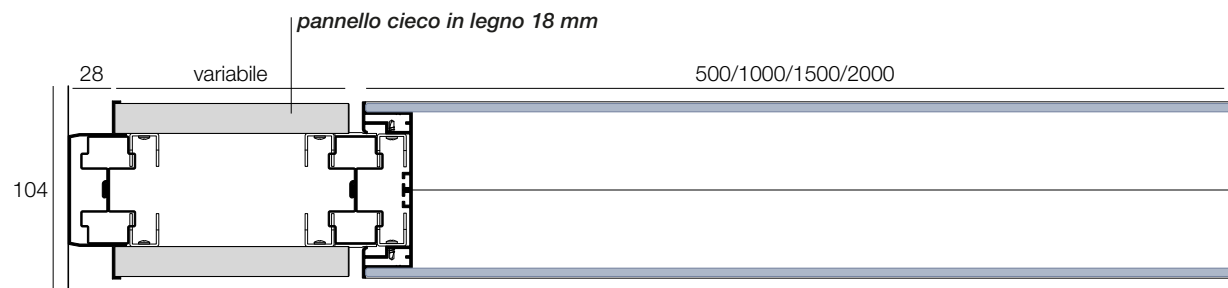

Partenza da tamponamento

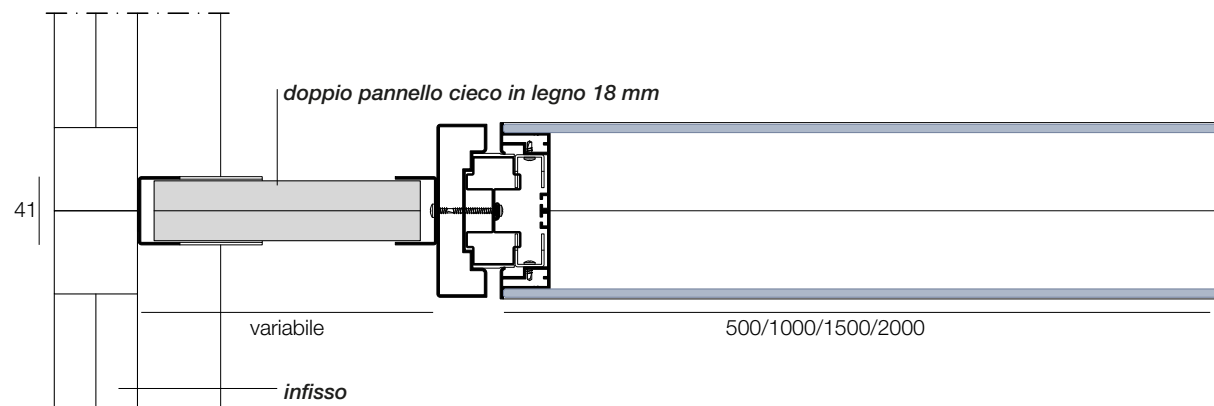

Partenza da parete

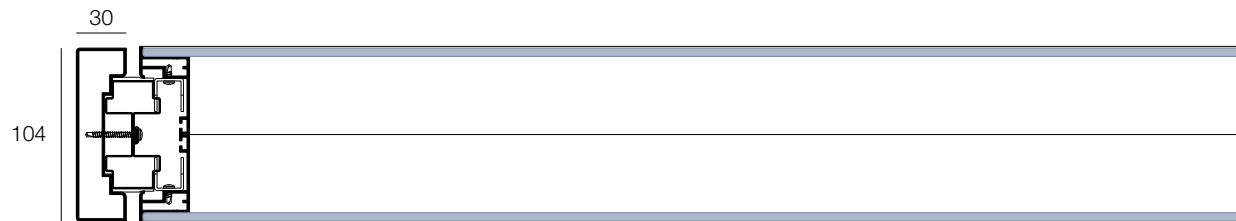

Profilo terminale

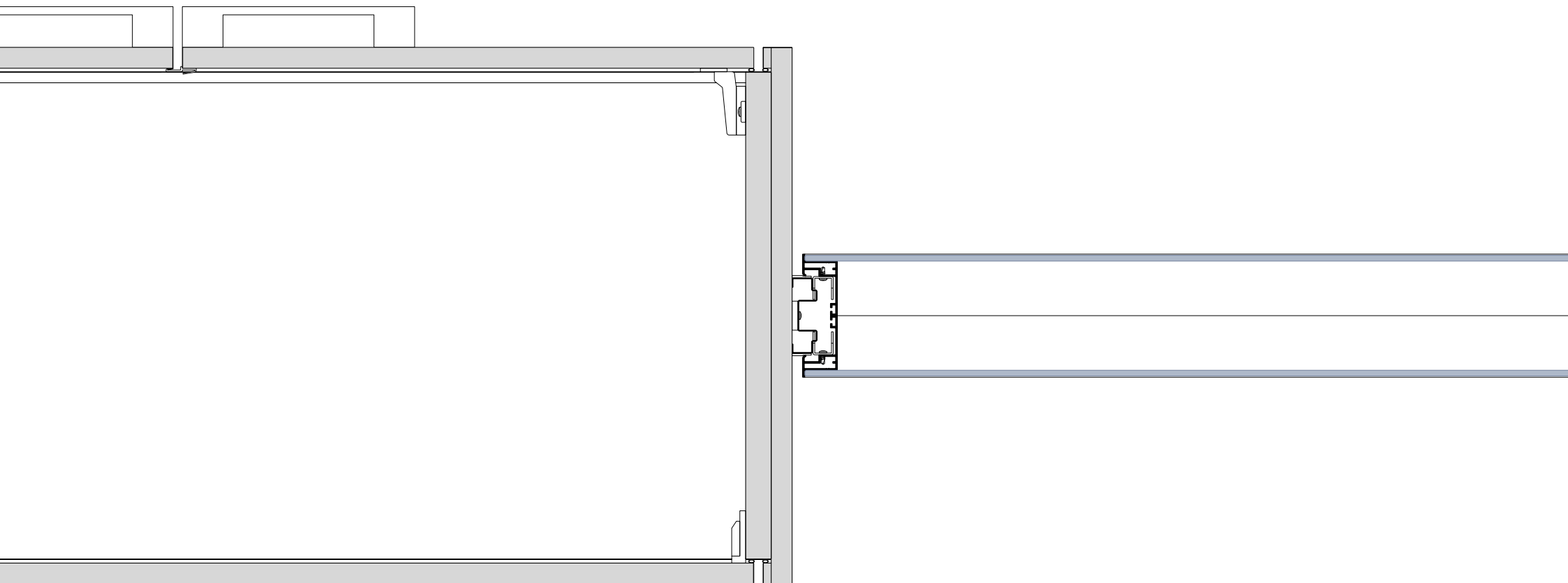

Partenza da contenitore

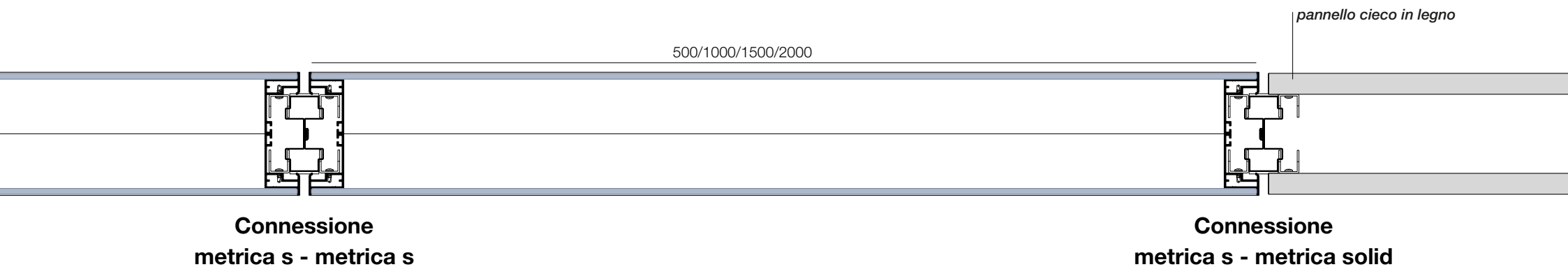

Angoli

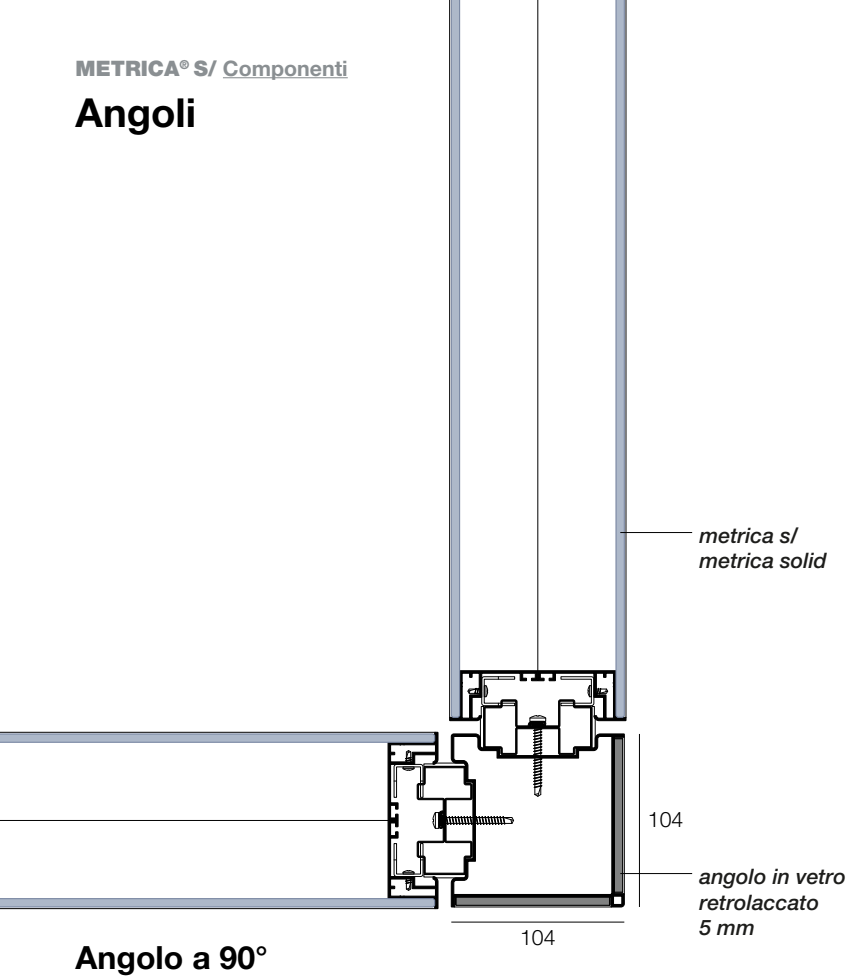

Angolo a 90°

Angolo 2 vie

Angolo variabile



Angolo 3 vie

Angolo 4 vie

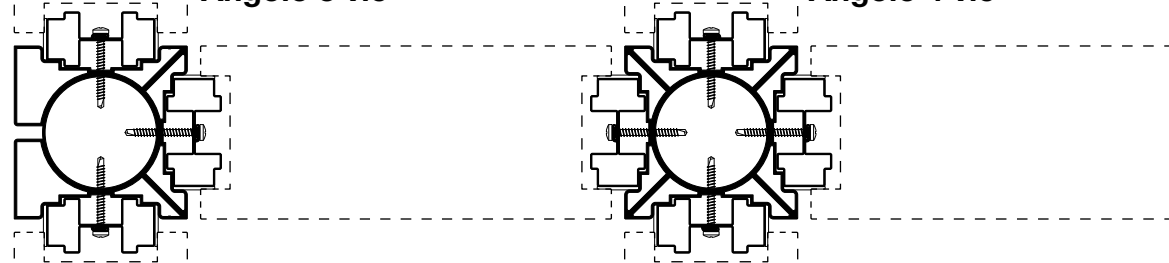

Cablaggio e modulo tecnico della porta a battente



Modulo tecnico

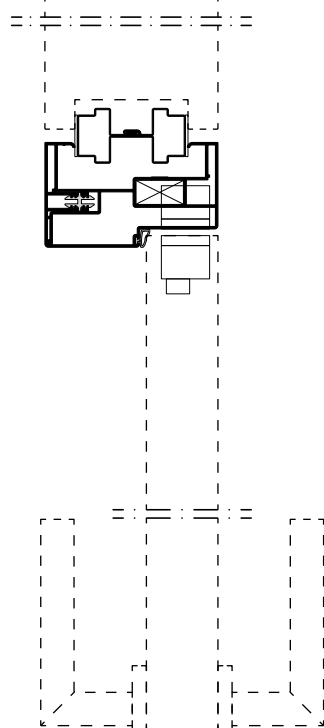
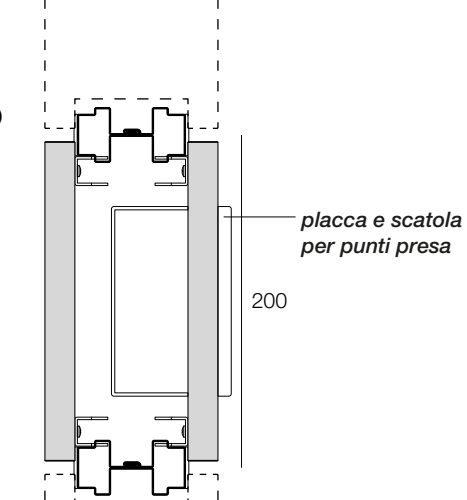

Soluzione di cablaggio

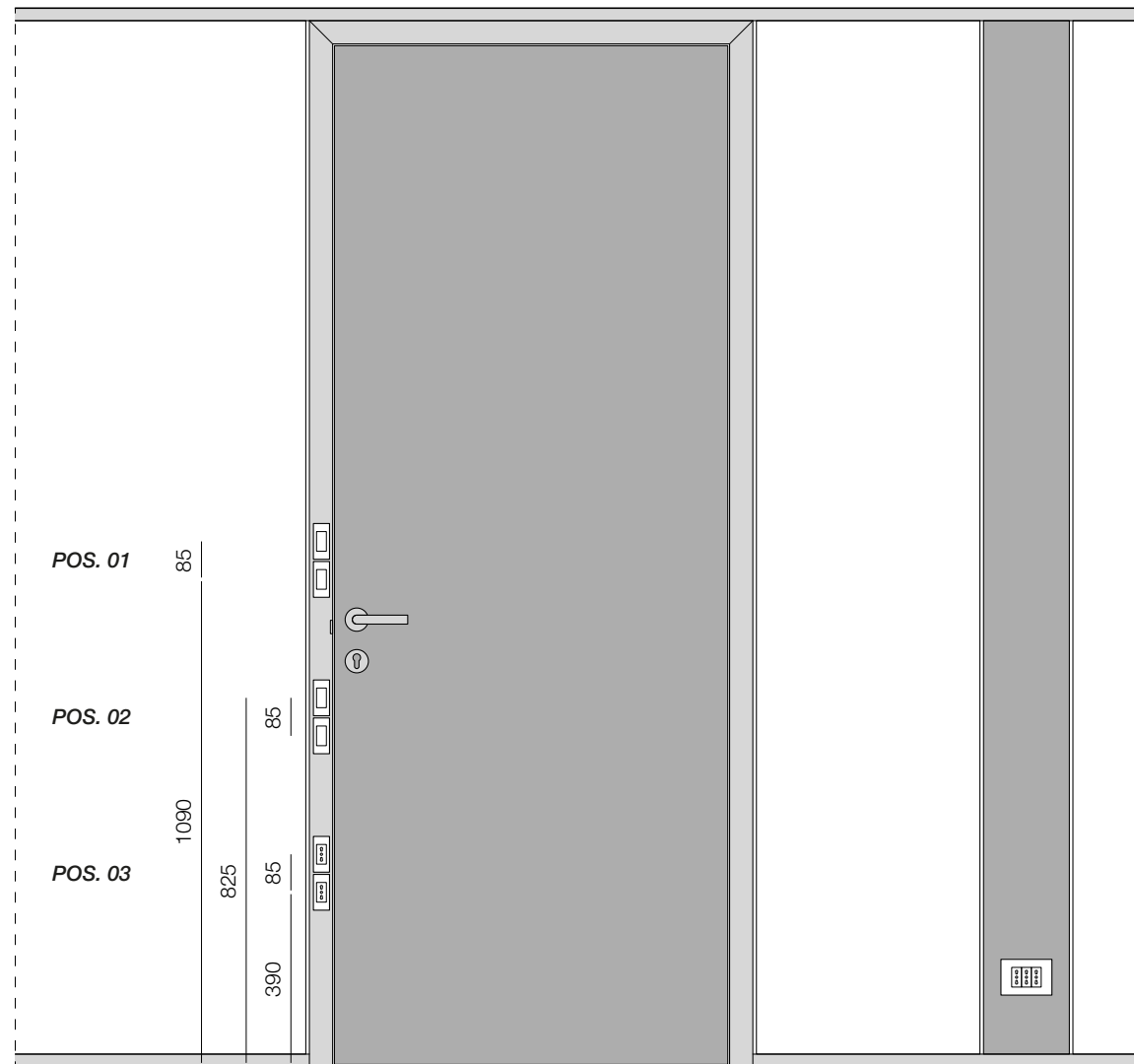
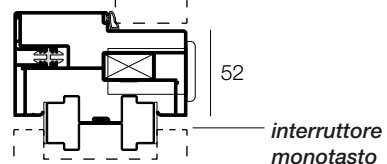

*posizioni possibili di interruttori e prese su telaio porta

Modulo tecnico della porta scorrevole



Modulo tecnico

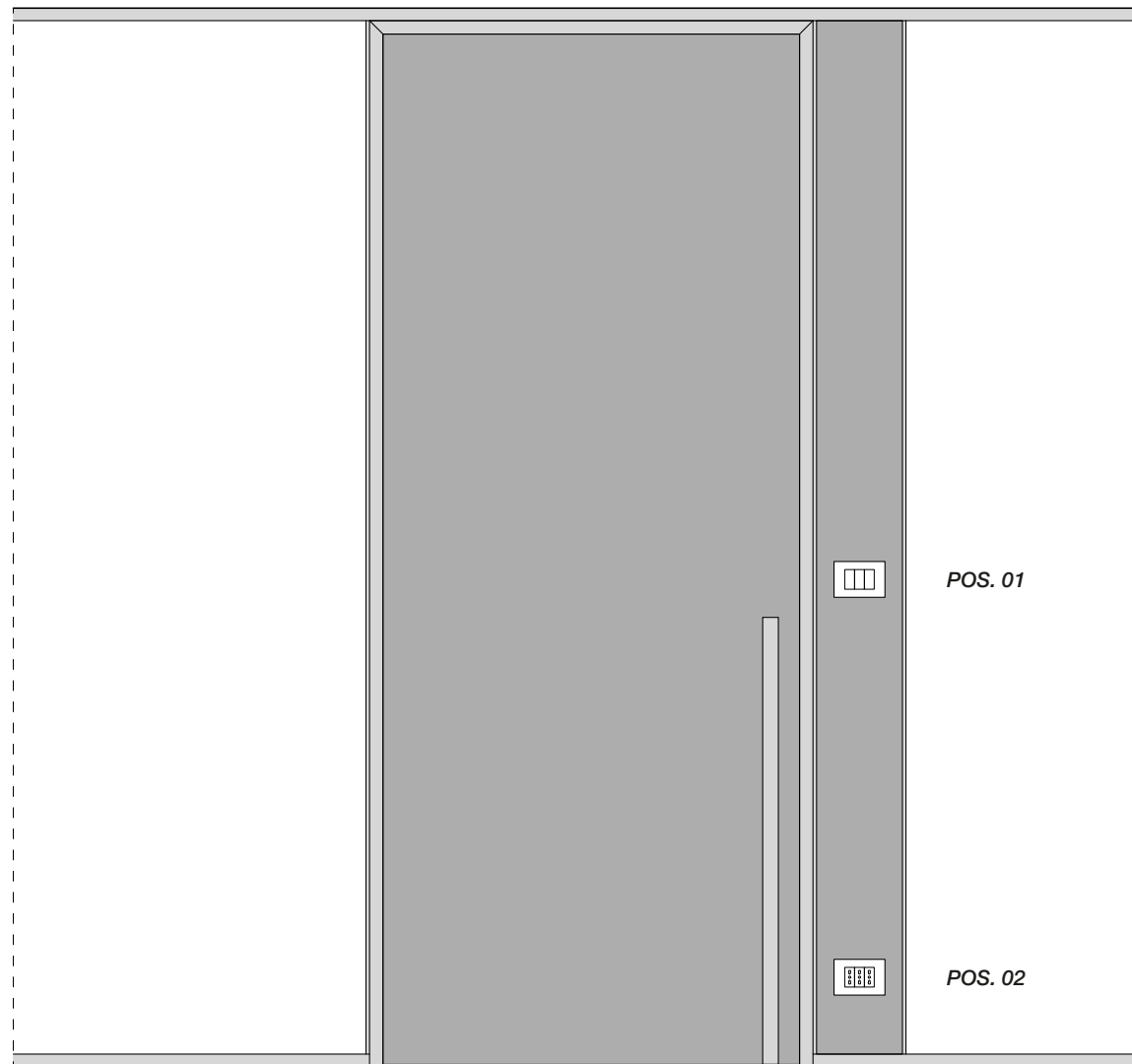
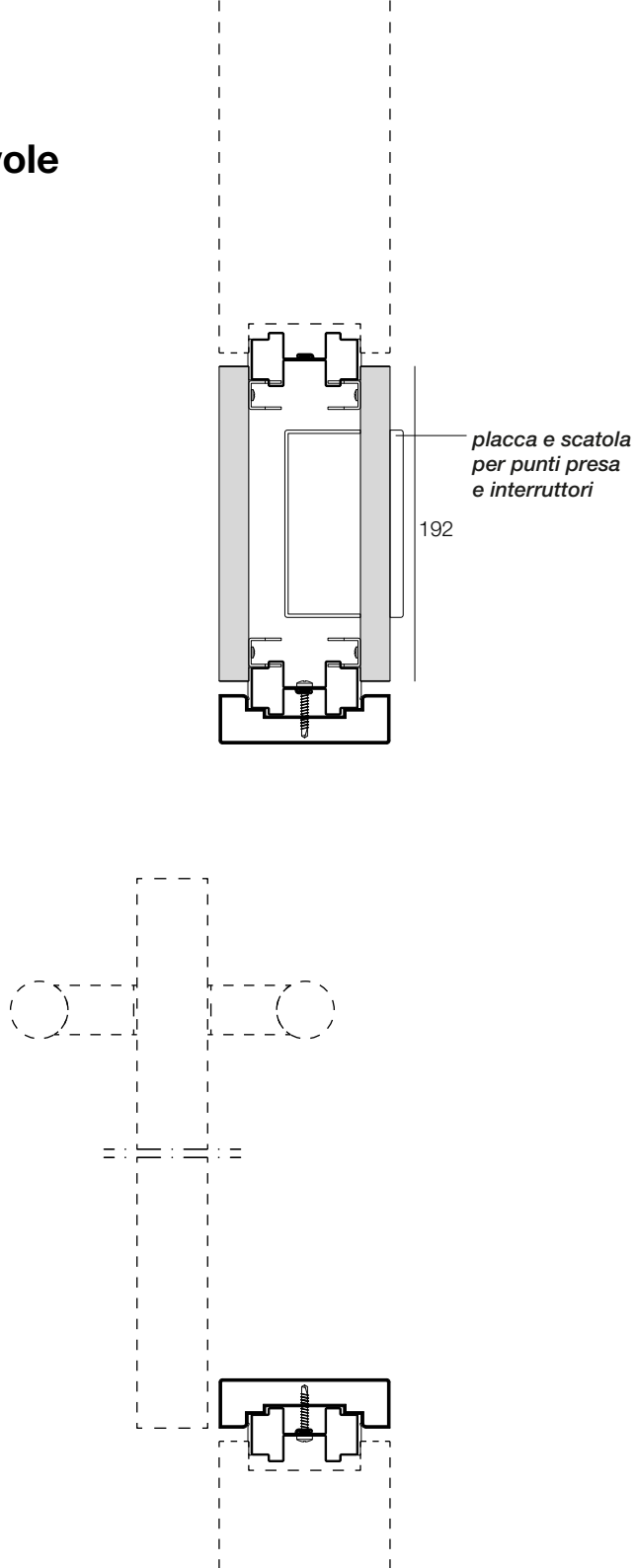

*posizioni possibili di interruttori e prese su modulo tecnico

METRICA[®] SOLID

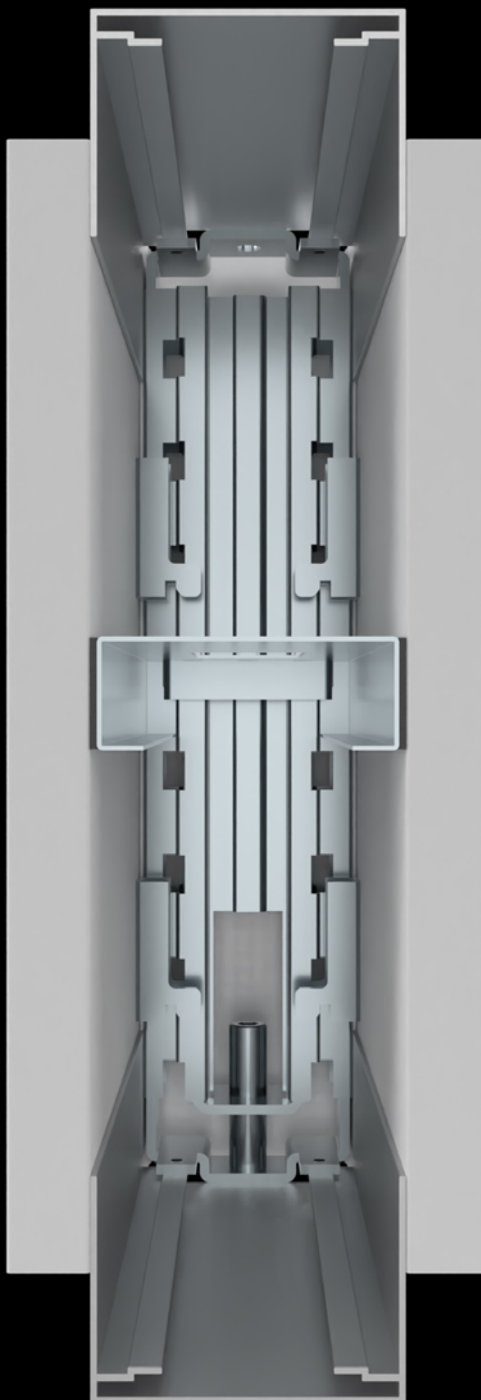



- 01.** Spessore 104 mm
- 02.** Struttura portante in lamiera zincata UNI EN 10143
- 03.** Parete a pannelli verticali e fasce orizzontali
- 04.** Pannelli a passo 500/1000/1500/2000 mm
- 05.** Doppi pannelli ciechi di nobilitato melaminico, laccati o impiallacciati - spessore 18 mm
- 06.** Profili d'angolo fissi e variabili - connessioni 2/3/4 vie
- 07.** Telaio porta cablabile
- 08.** Modulo tecnico ispezionabile
- 09.** 11 versioni di porte battenti - cieche, in vetro temperato e intelaiate
- 10.** 2 versioni di porte scorrevoli interne - cieche e in vetro temperato
- 11.** 5 versioni di porte scorrevoli esterne - cieche, in vetro temperato e intelaiate

- 01.** Pannelli verticali + coibentazione da **37 dB** a **44 dB**
- 02.** Pannelli orizzontali + coibentazione da **38 dB** a **46 dB**



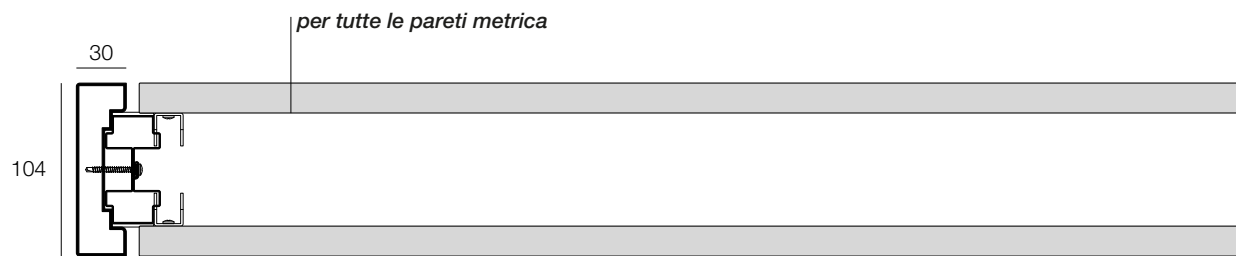

Profilo terminale

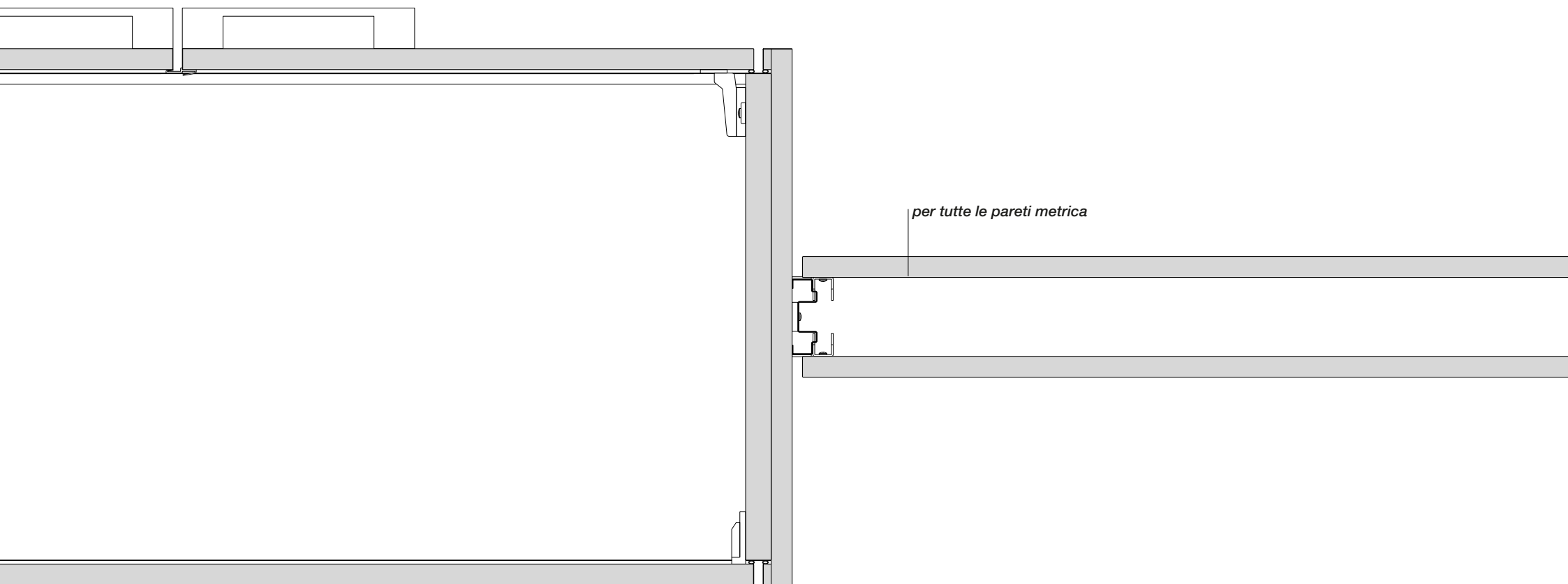

Partenza da contenitore

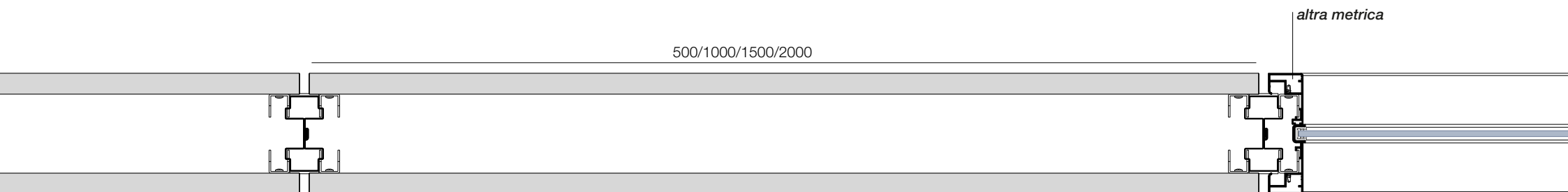

**Conessione
metrica solid - metrica solid**

**Conessione
metrica solid - altra metrica**

Angoli

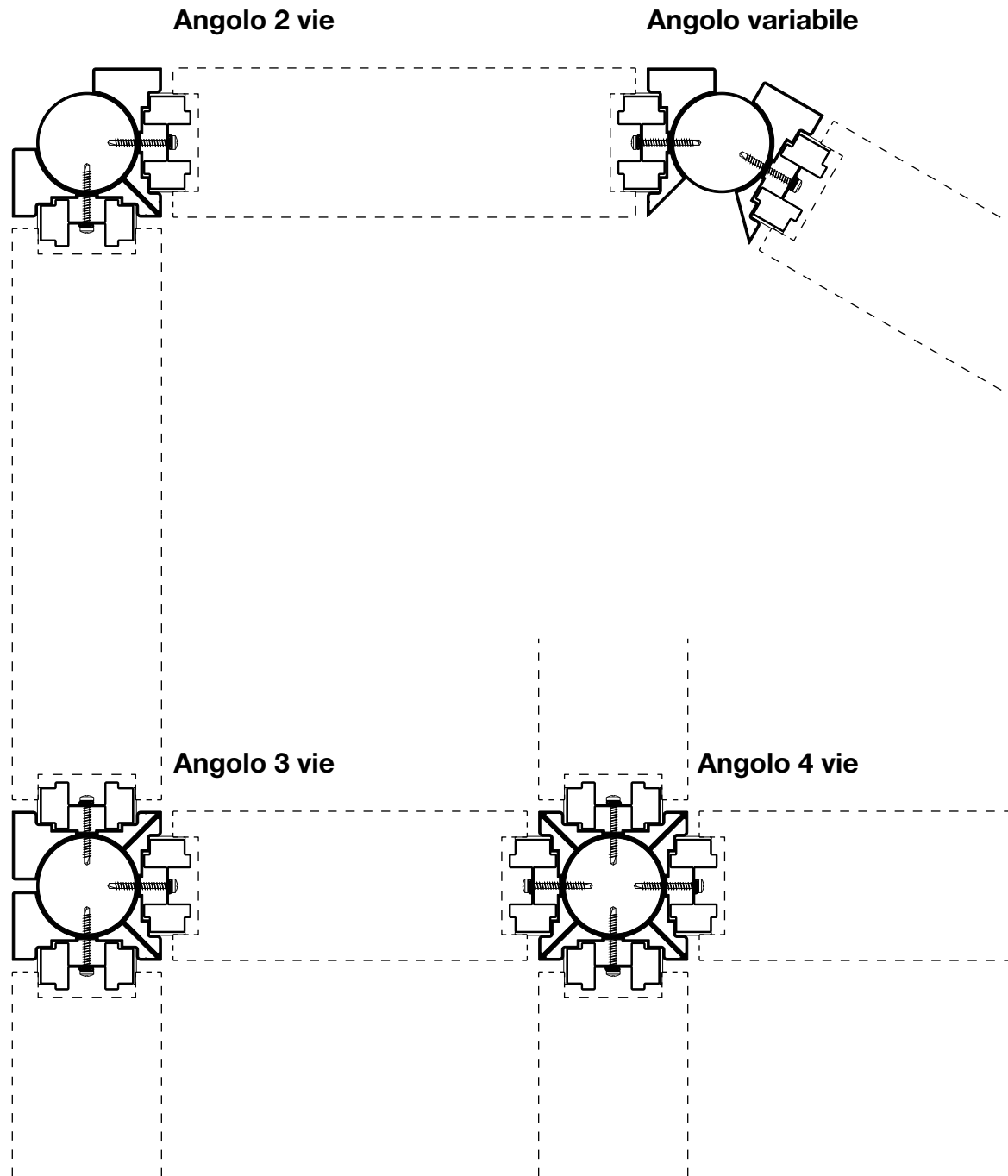
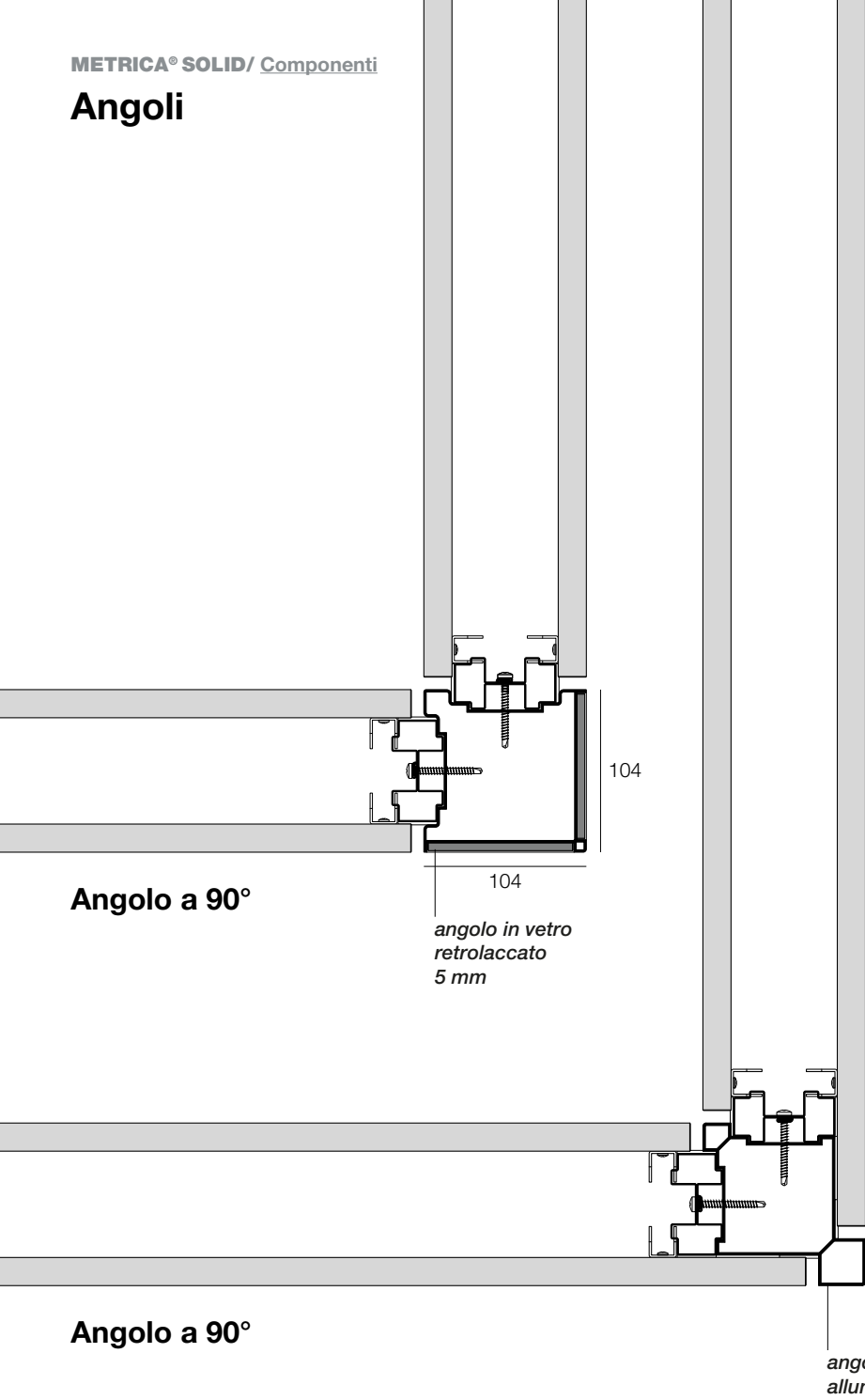

Cablaggio e modulo tecnico della porta a battente



Modulo tecnico

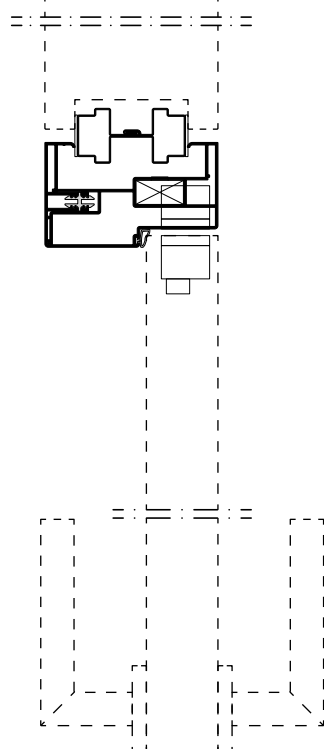
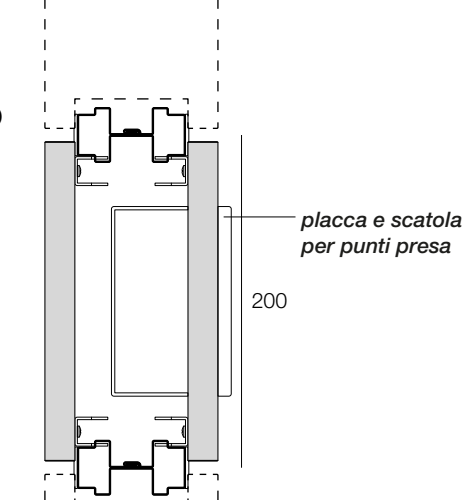

Soluzione di cablaggio

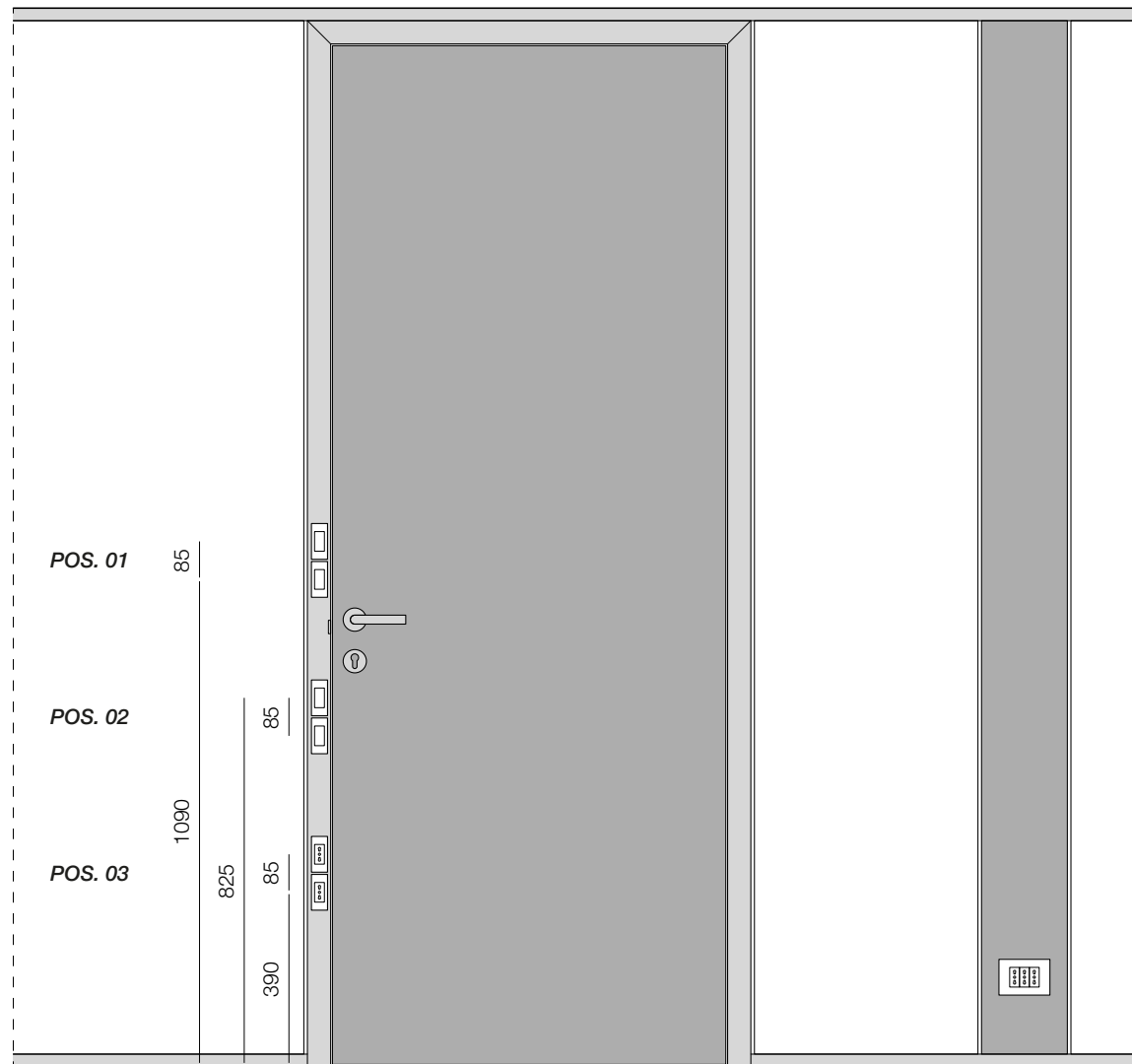
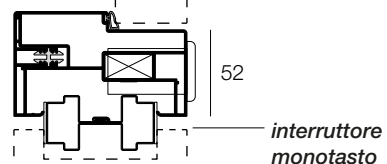

**posizioni possibili di interruttori e prese su telaio porta*

Modulo tecnico della porta scorrevole



Modulo tecnico

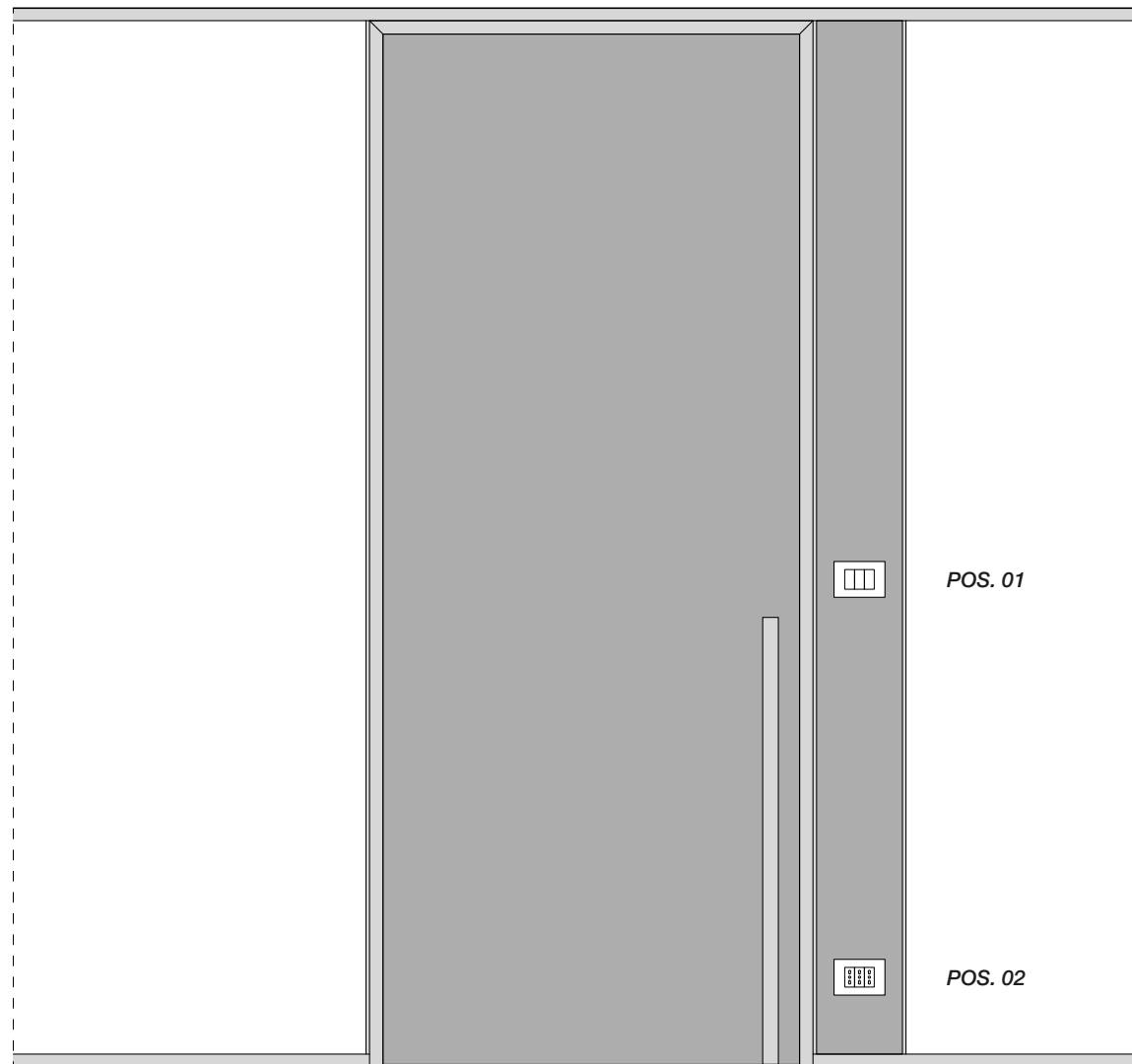
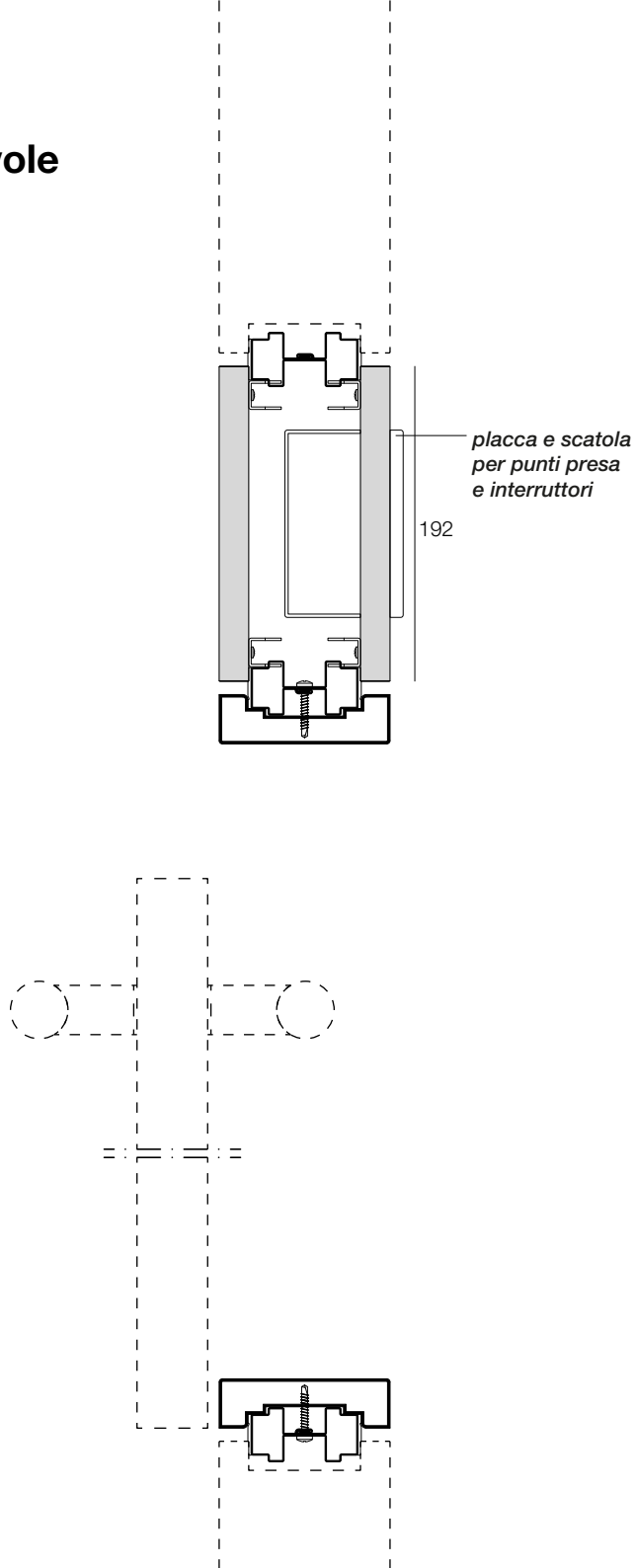

*posizioni possibili di interruttori e prese su modulo tecnico

METRICA[®]
STRUTTURALE

Porte e maniglie

TELAI PORTE BATTENTI



Telaio porta su **Metrica R**

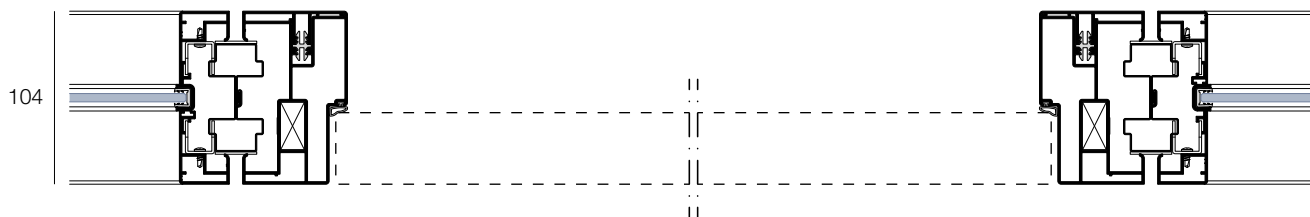

Telaio porta su **Metrica V**

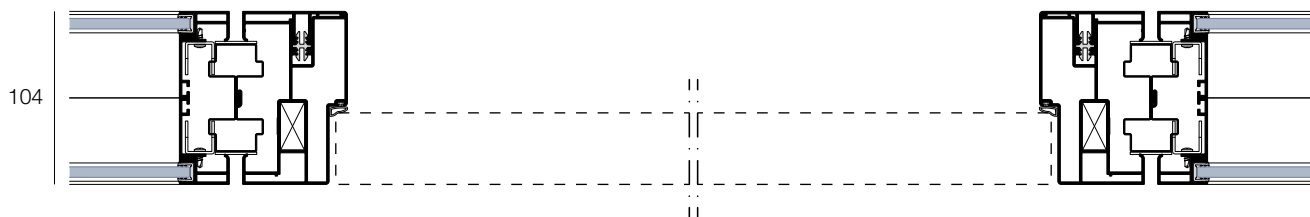

Telaio porta su **Metrica S**

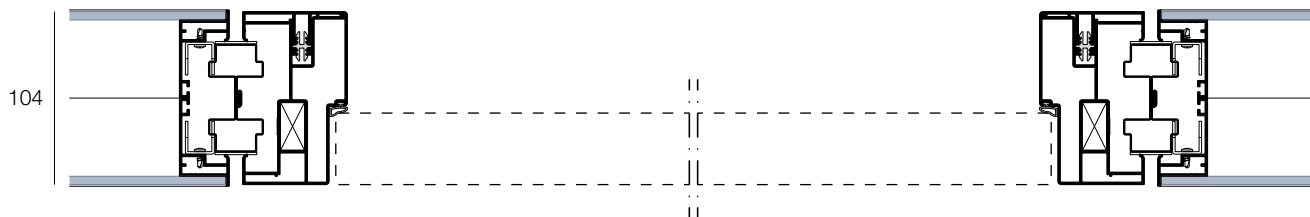

Telaio porta su **Metrica Solid**

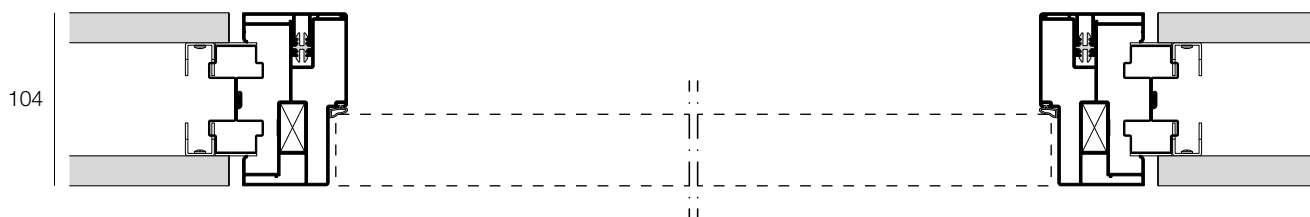

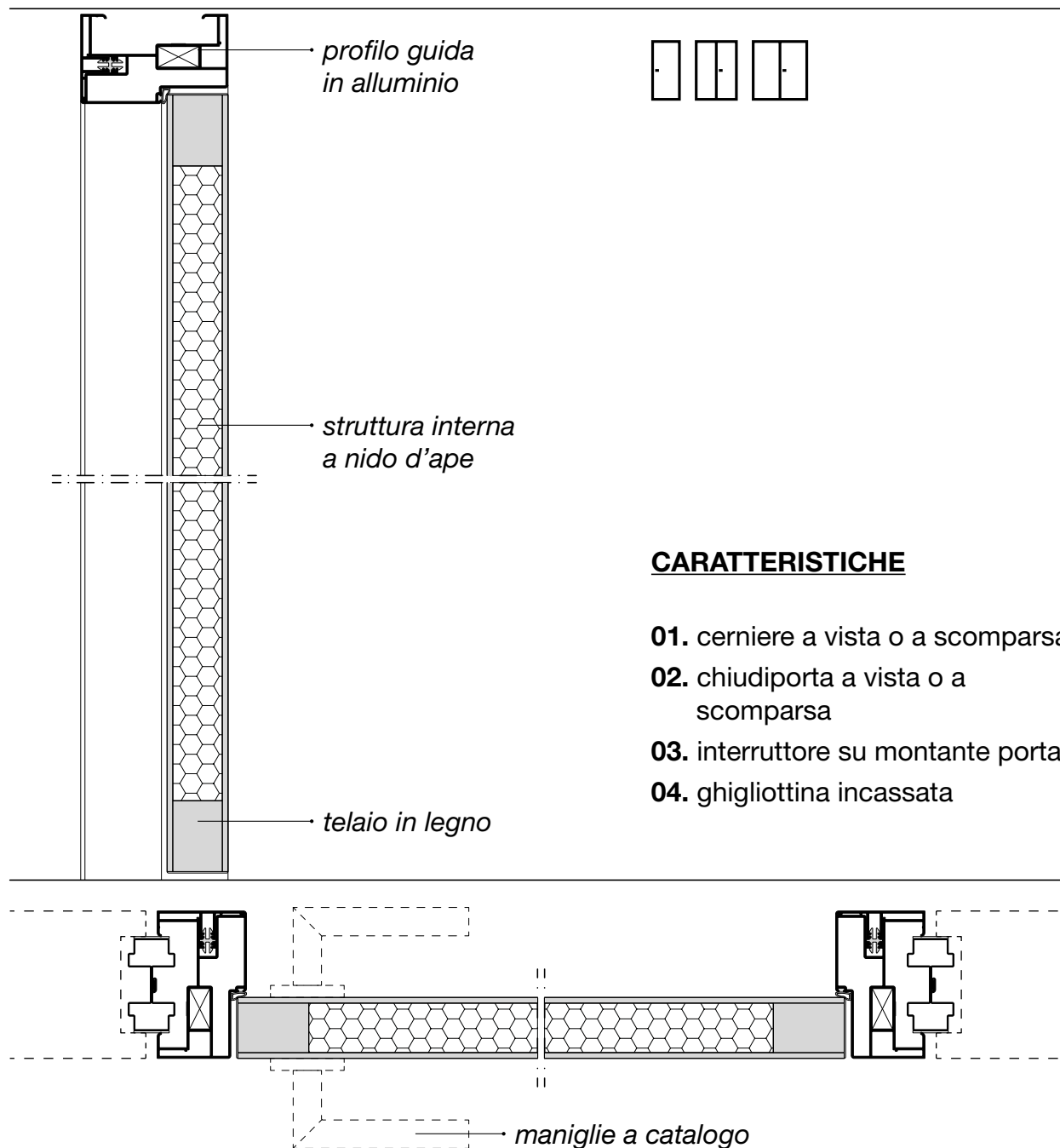

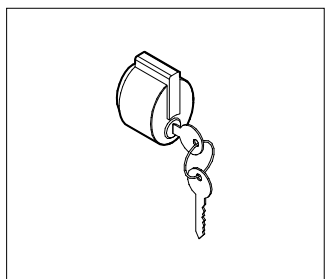

ML1

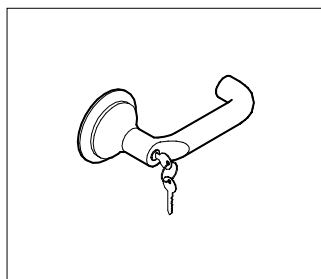

ML4

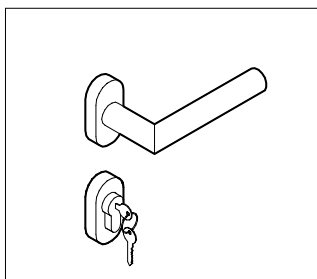

ML5

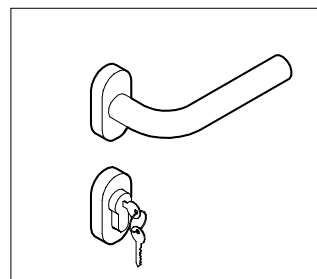

ML6

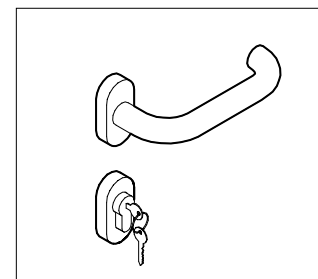

ML7

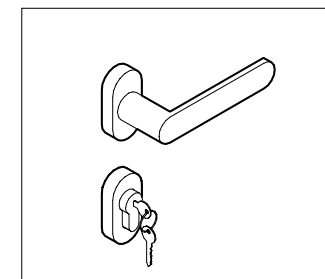

ML8

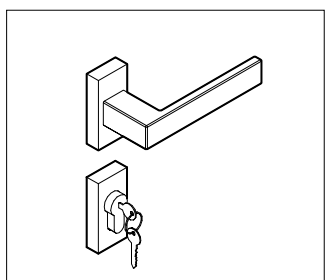

ML9

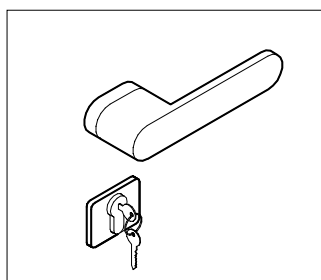

ML10

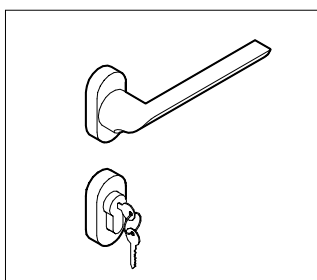

ML11

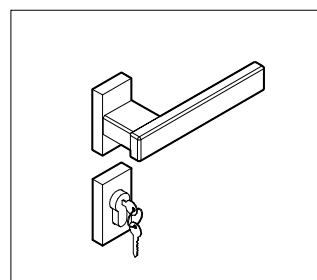

MLQ

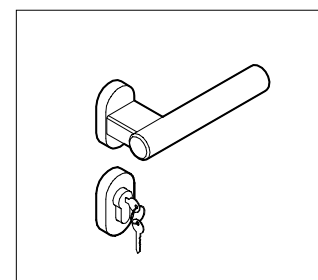

MLT

ANTA VETRO TEMPERATO_CERNIERE A VISTA sp. 10 mm

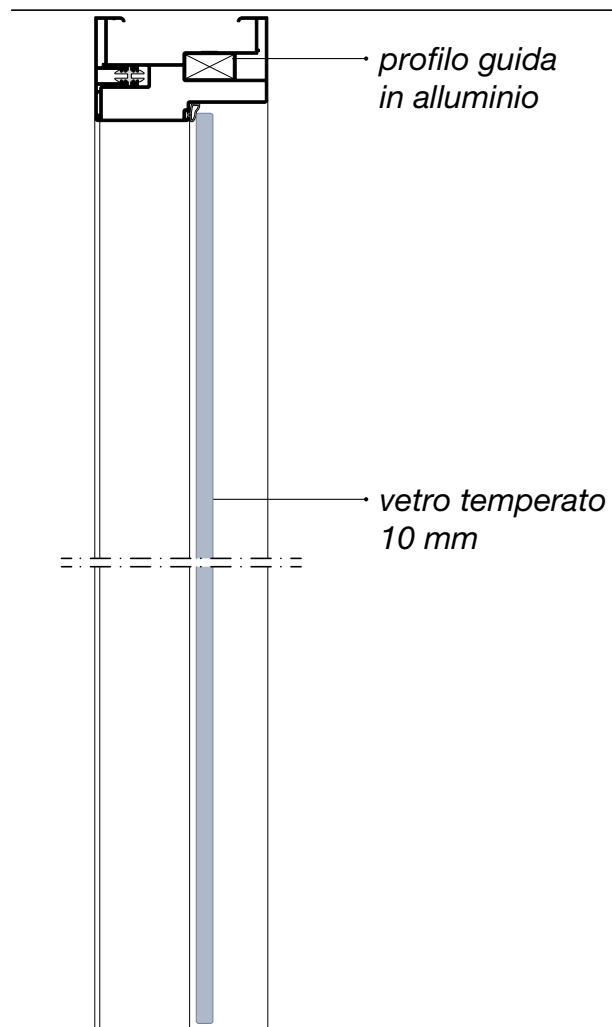
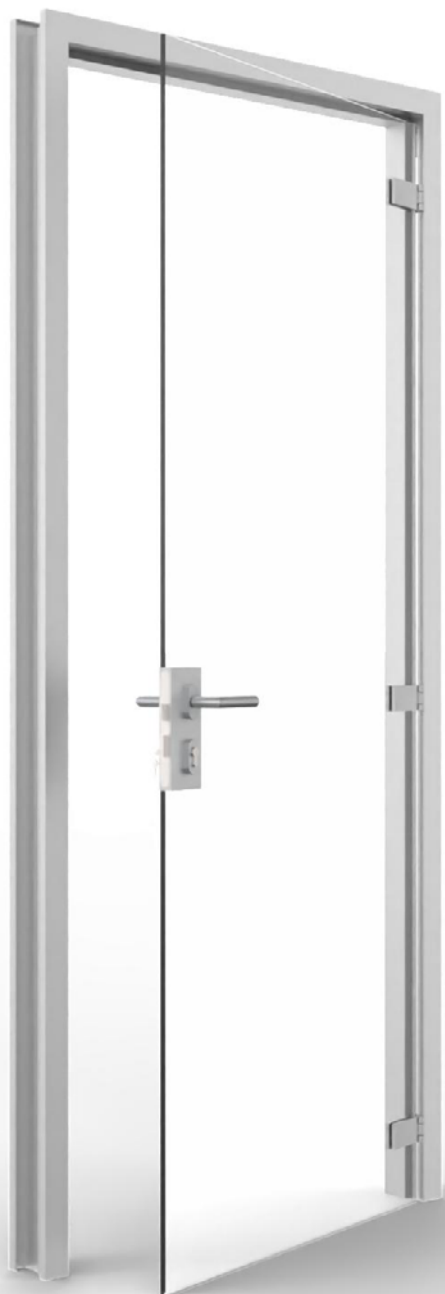

CARATTERISTICHE

- 01. cerniere a vista - 110° o 180°
- 02. chiudiporta a vista
- 03. maniglia con adattatore per vetro
- 04. interruttore su montante porta
- 05. ghigliottina esterna

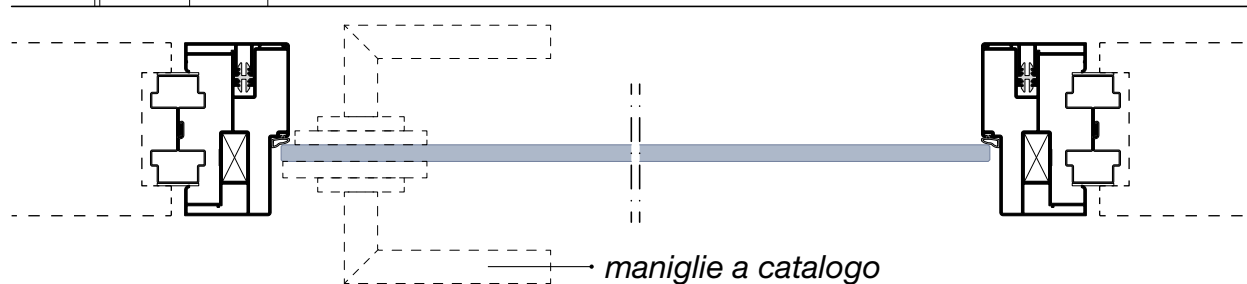

ANTA VETRO TEMPERATO_CERNIERE A VISTA sp. 10 mm

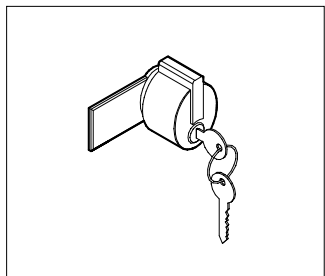

MC1

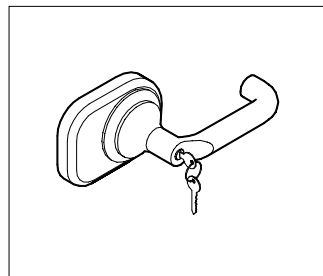

MC4

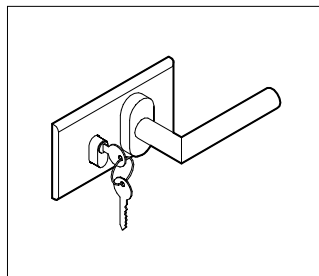

MC5

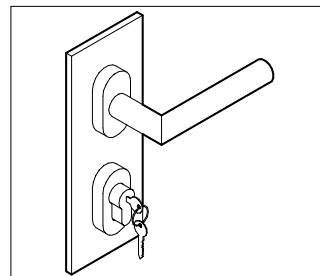

MC5V

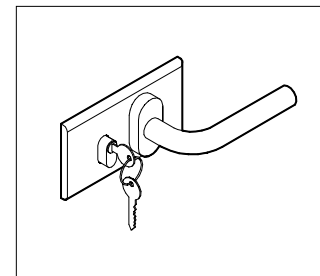

MC6

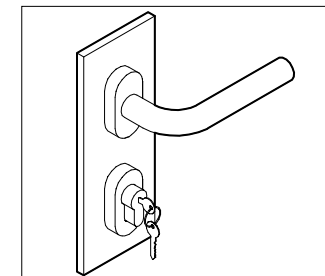

MC6V

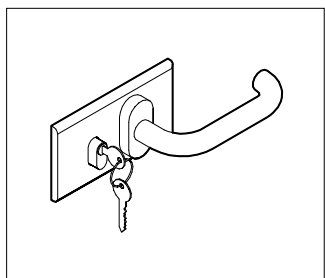

MC7

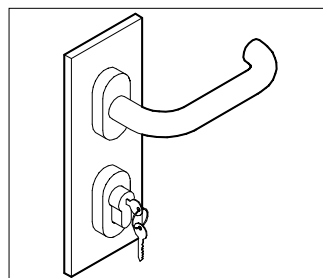

MC7V

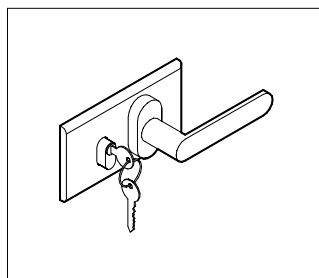

MC8

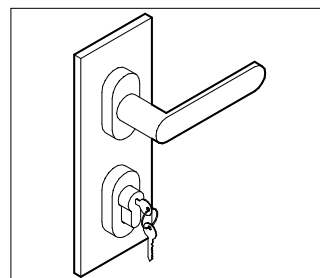

MC8V

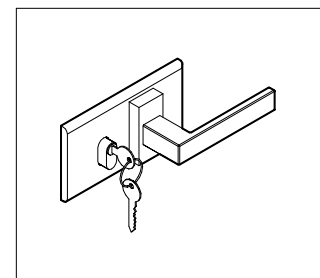

MC9

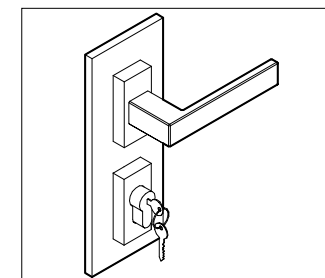

MC9V

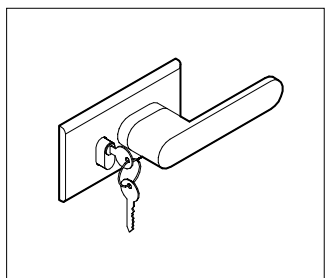

MC10

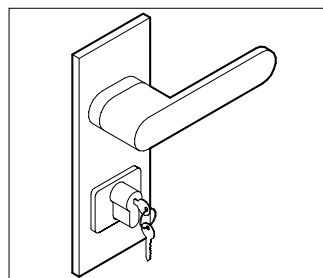

MC10V

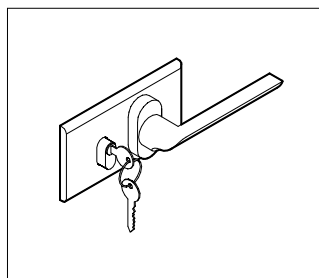

MC11

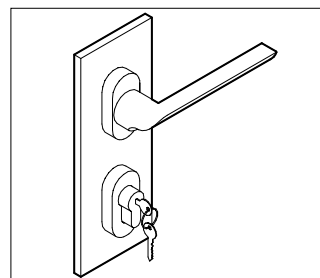

MC11V

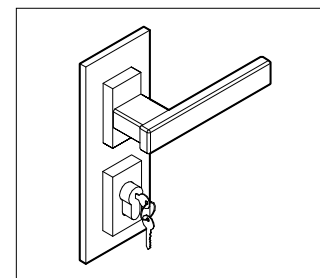

MCQ

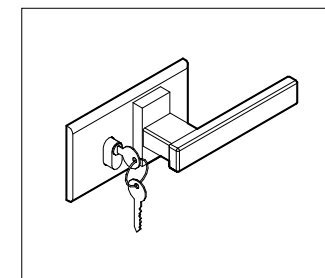

MCQO

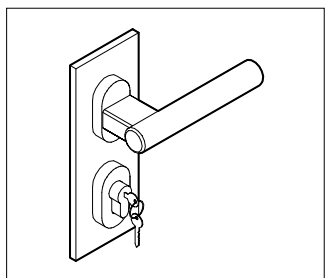

MCT

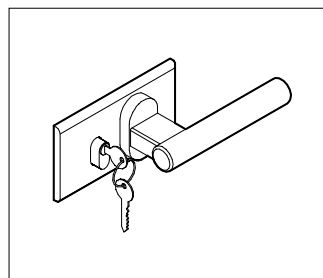

MCTO

ANTA VETRO TEMPERATO_CERNIERA CONTINUA sp. 10 mm

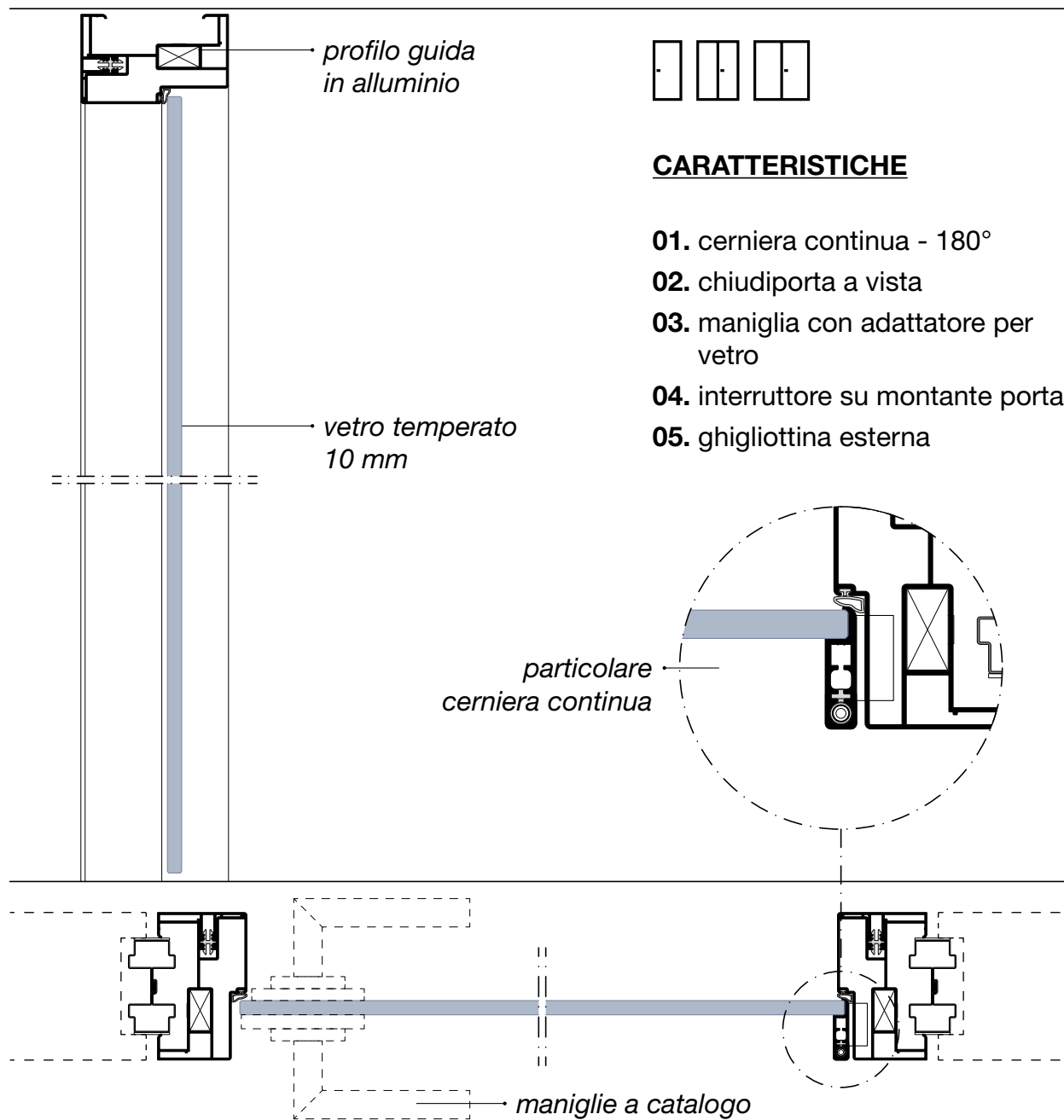
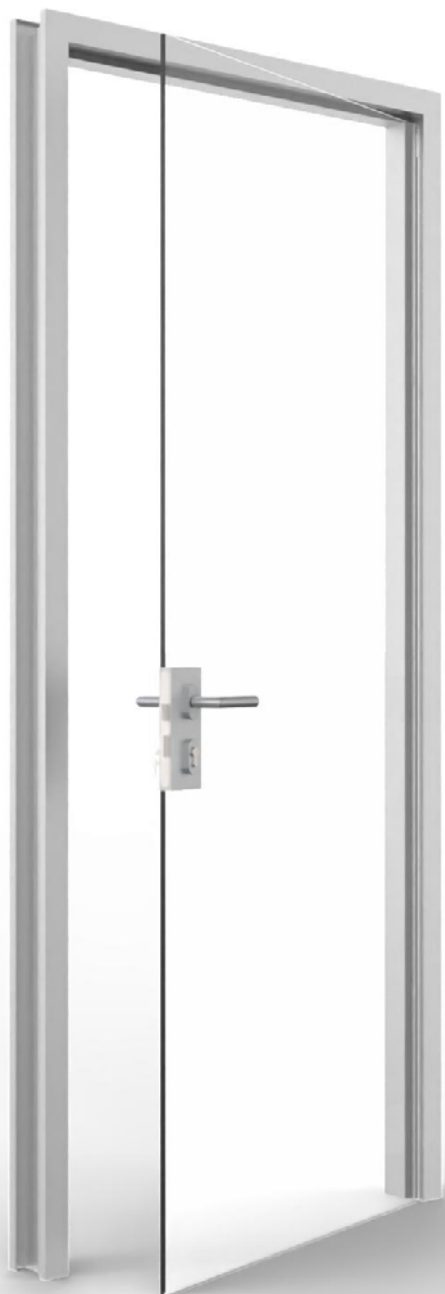

ANTA VETRO TEMPERATO_CERNIERA CONTINUA sp. 10 mm

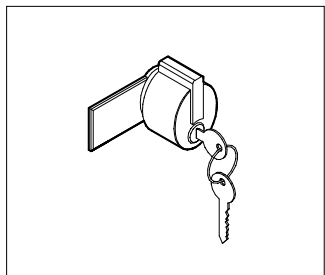

MC1

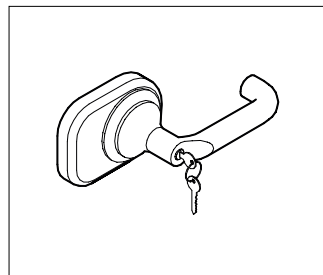

MC4

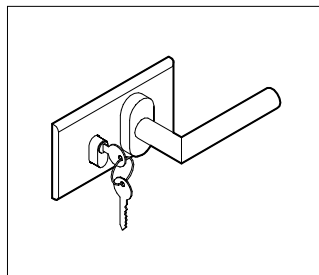

MC5

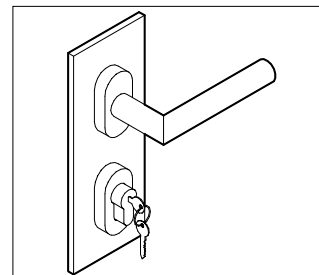

MC5V

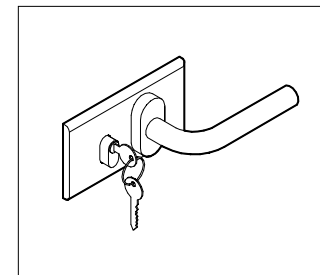

MC6

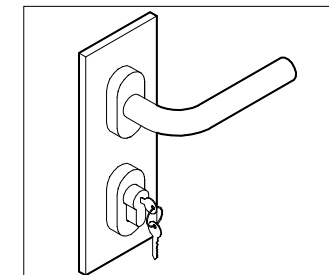

MC6V

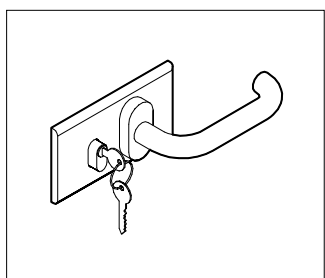

MC7

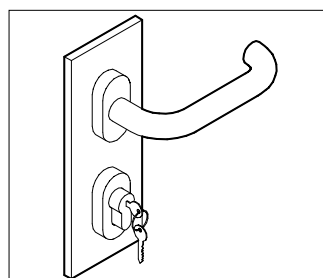

MC7V

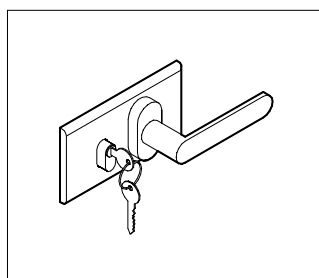

MC8

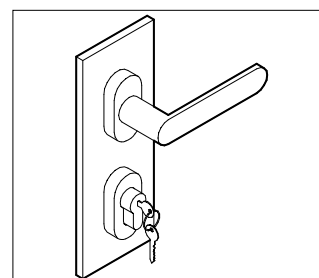

MC8V

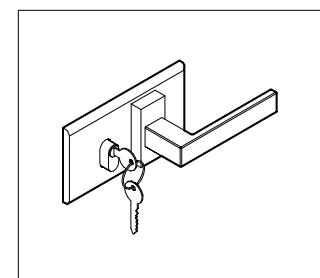

MC9

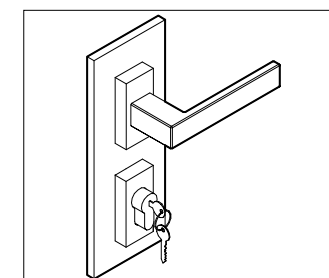

MC9V

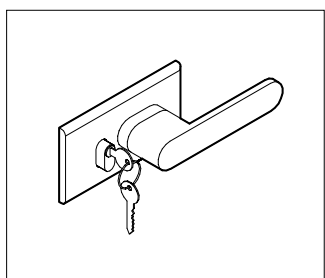

MC10

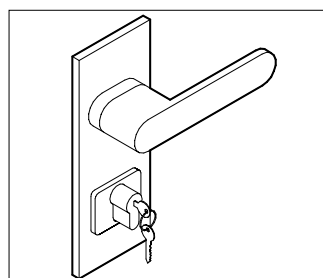

MC10V

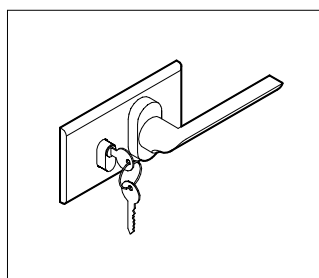

MC11

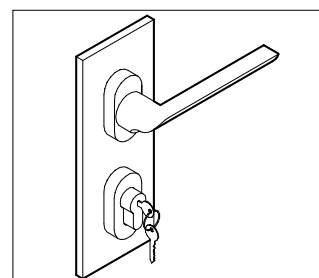

MC11V

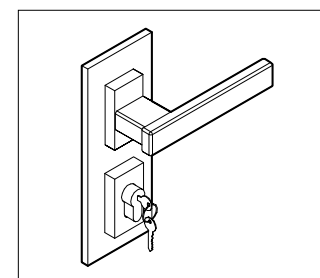

MCQ

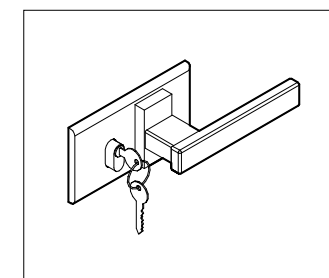

MCQO

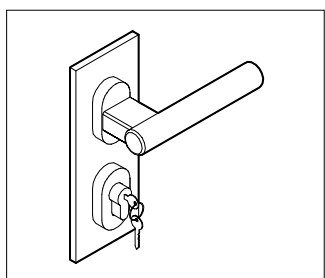

MCT

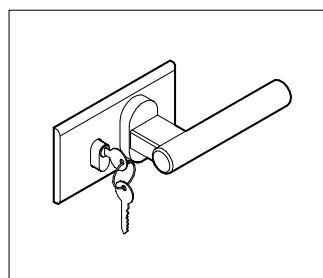

MCTO

ANTA INTELAIATA GRANDE CON PANNELLO sp. 43 mm

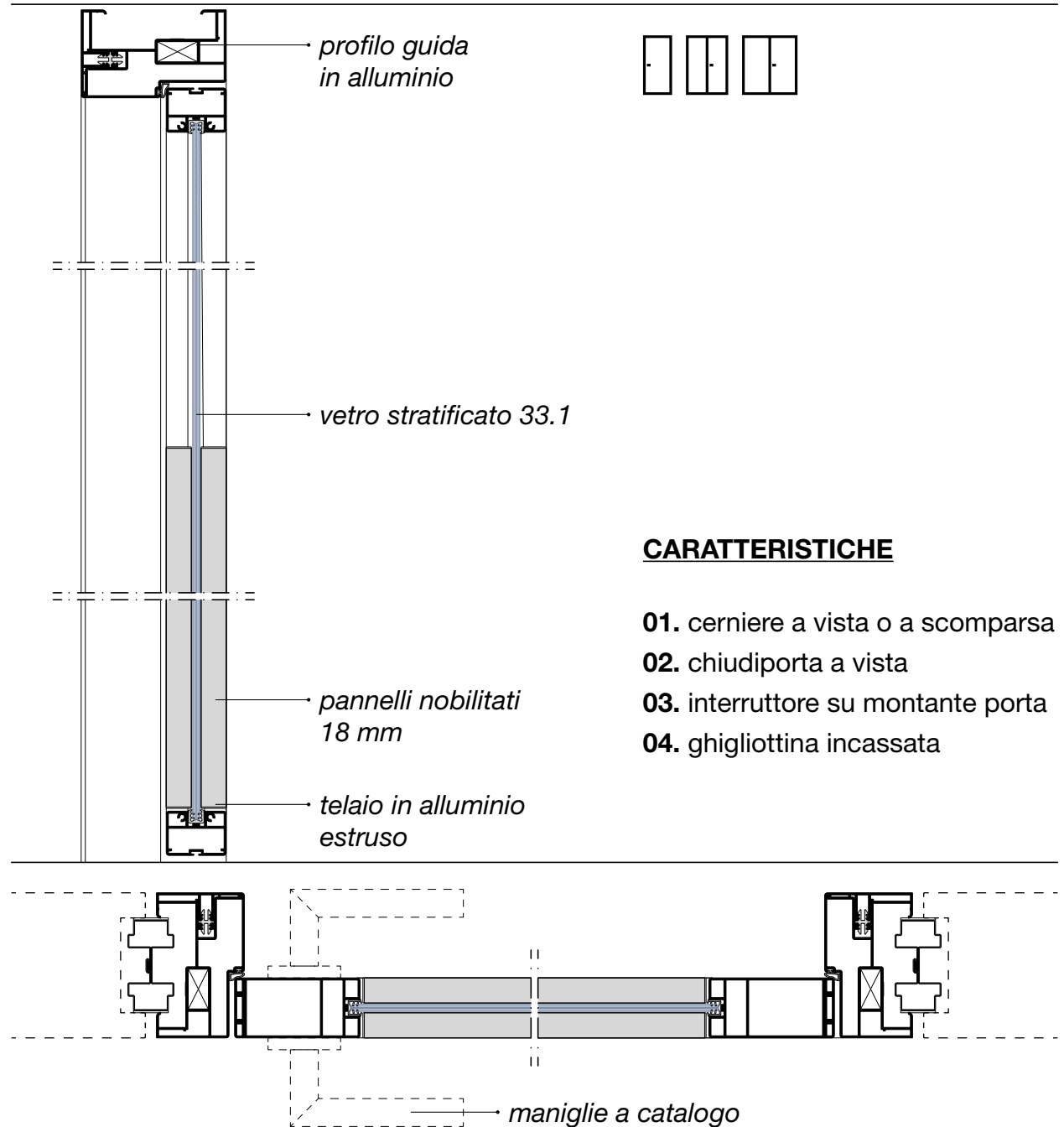

ANTA INTELAIATA GRANDE CON PANNELLO sp. 43 mm

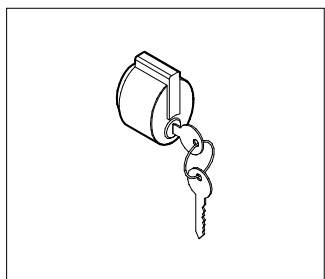

ML1

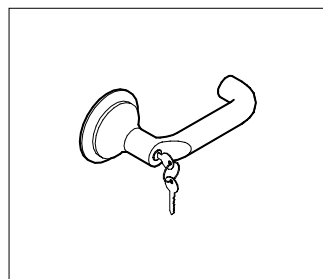

ML4

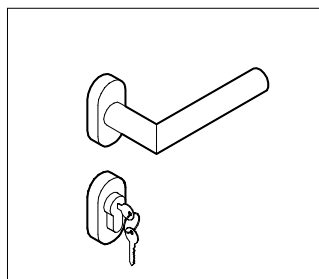

ML5

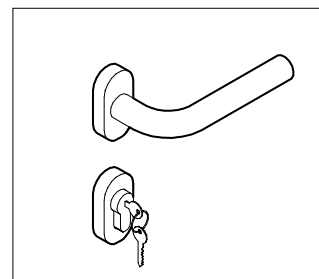

ML6

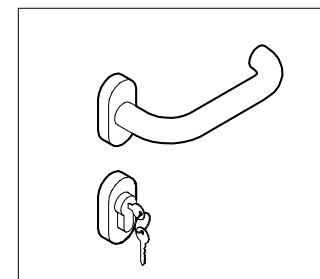

ML7

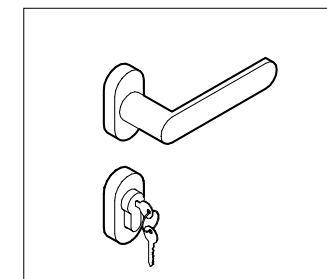

ML8

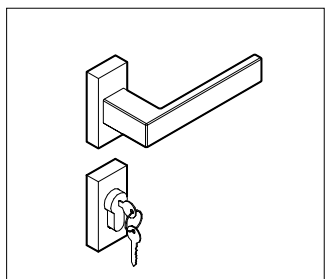

ML9

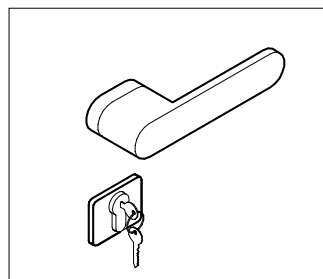

ML10

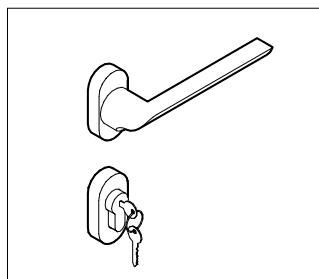

ML11

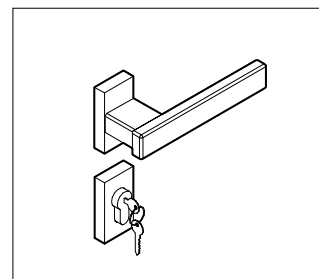

MLQ

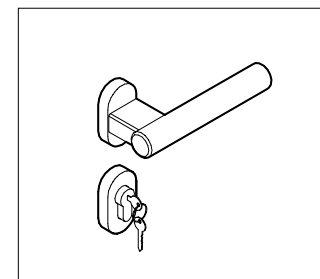

MLT

ANTA INTELAIATA GRANDE sp. 43 mm

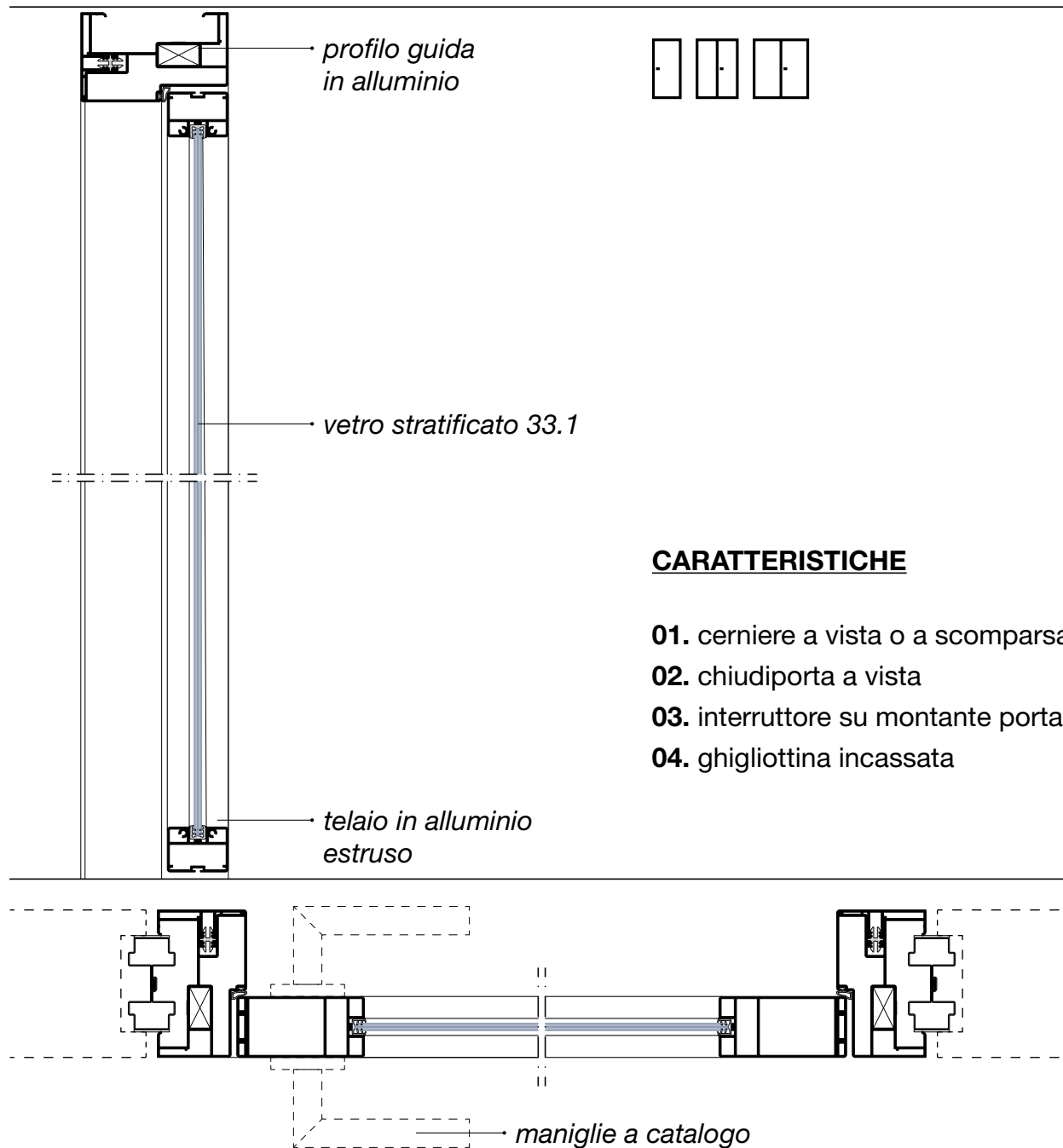

ANTA INTELAIATA GRANDE sp. 43 mm

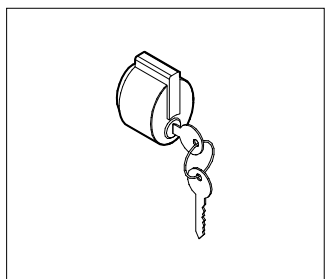

ML1

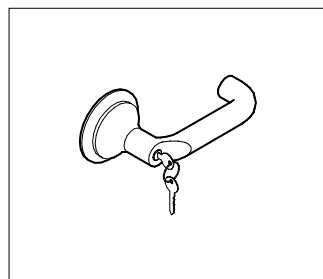

ML4

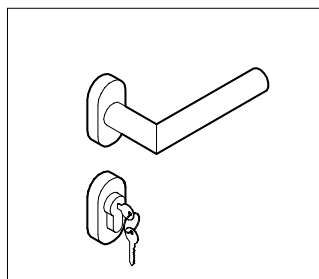

ML5

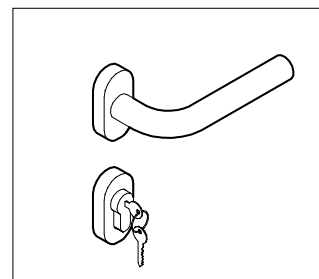

ML6

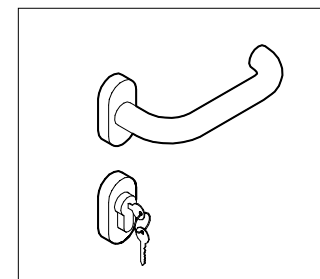

ML7

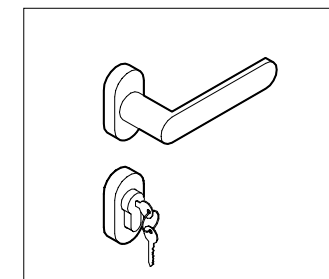

ML8

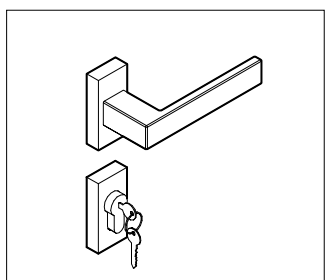

ML9

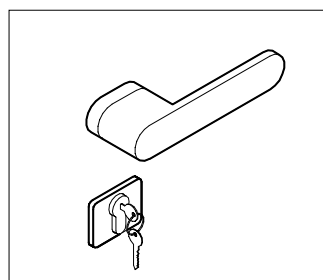

ML10

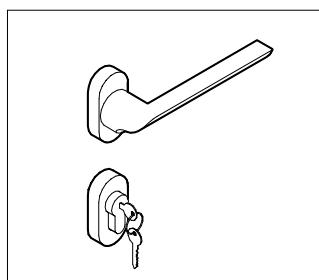

ML11

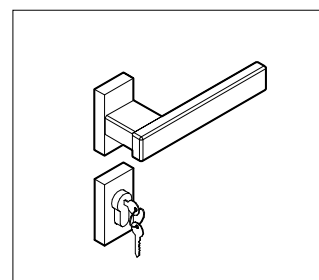

MLQ

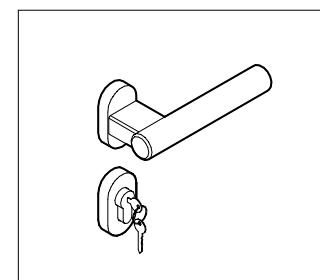

MLT

ANTA INTELAIATA MEDIA sp. 43 mm

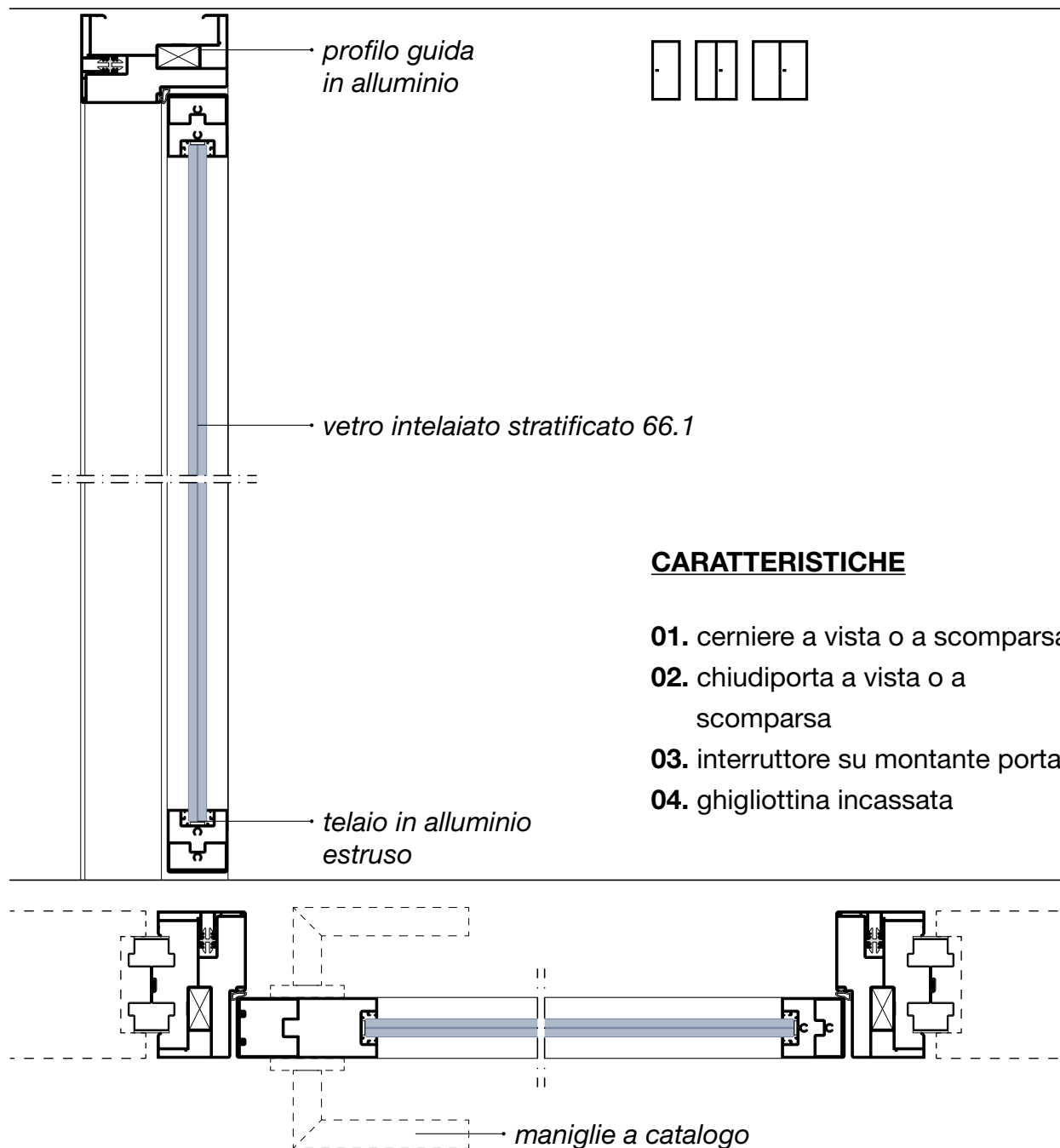

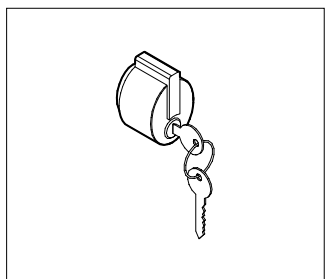

ML1

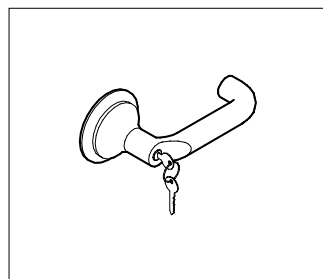

ML4

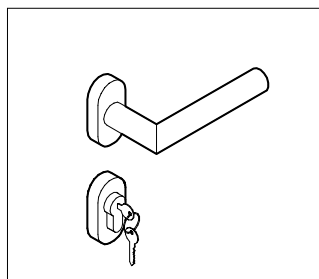

ML5

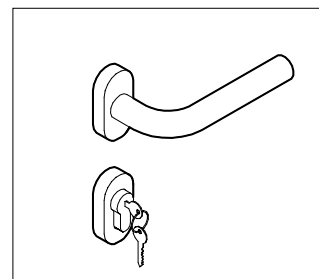

ML6

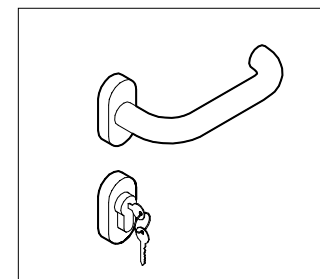

ML7

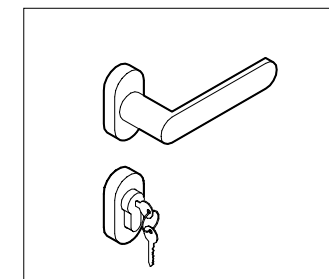

ML8

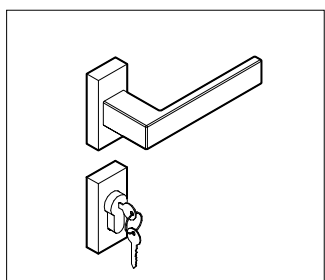

ML9

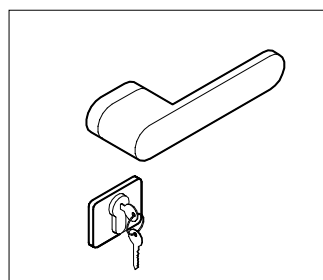

ML10

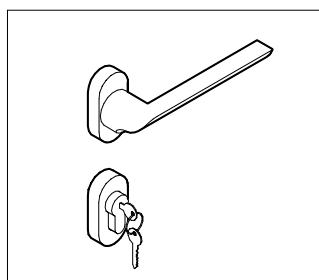

ML11

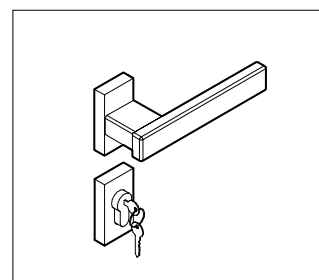

MLQ

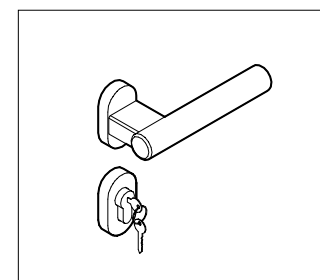

MLT

ANTA INTELAIATA SOTTILE sp. 43 mm

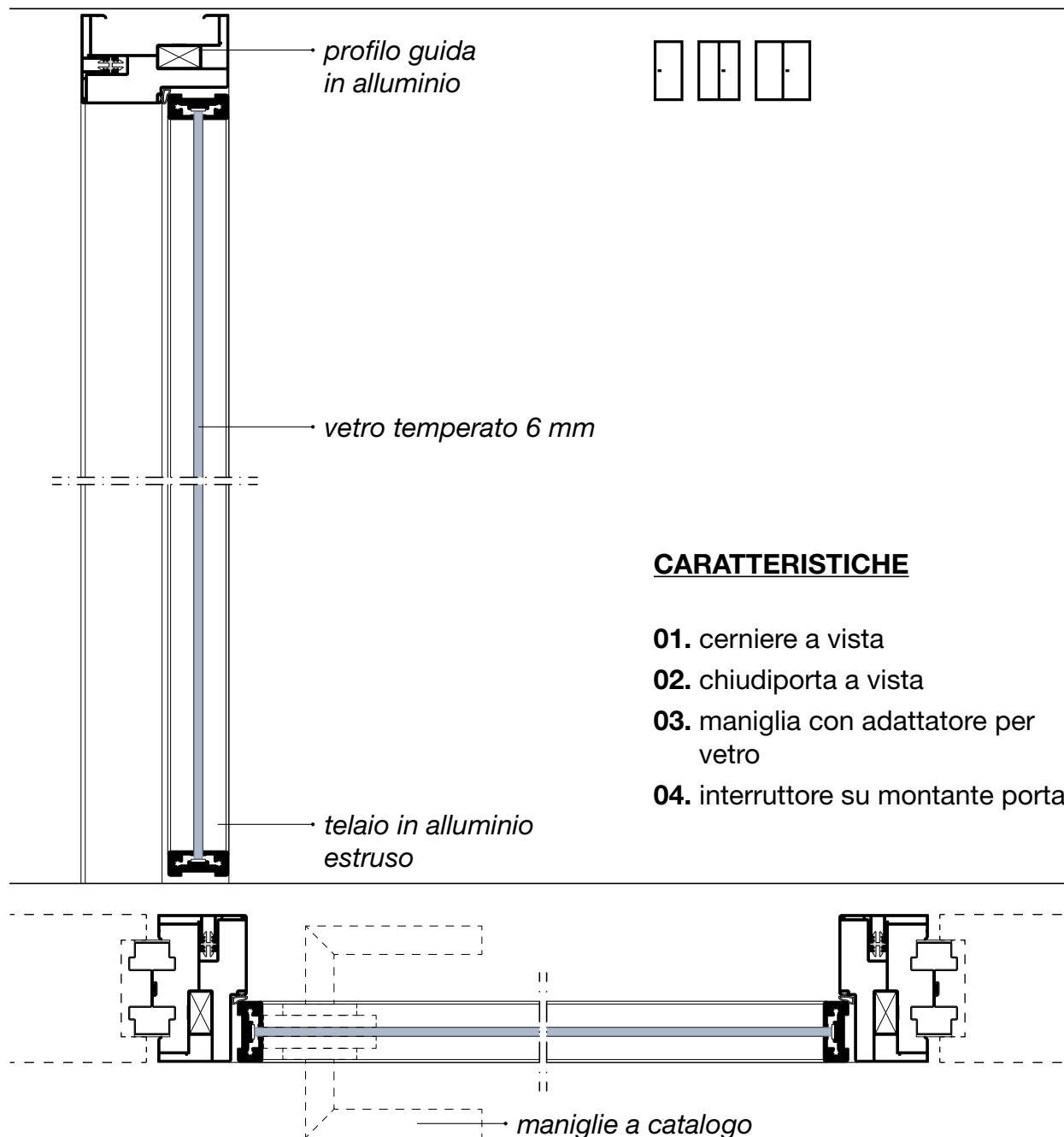

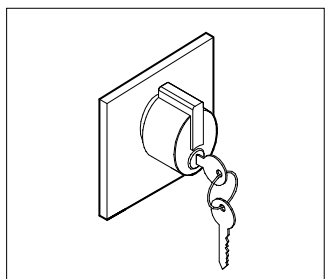

ML1

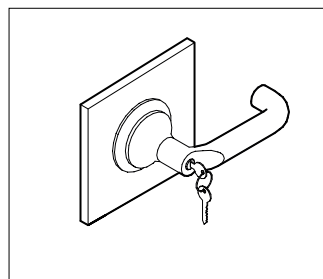

ML4

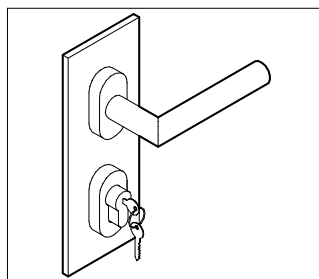

ML5

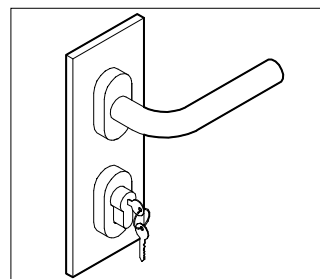

ML6

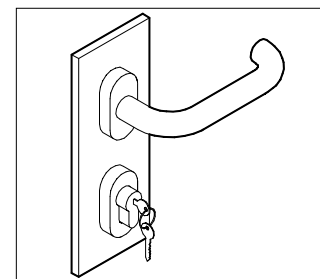

ML7

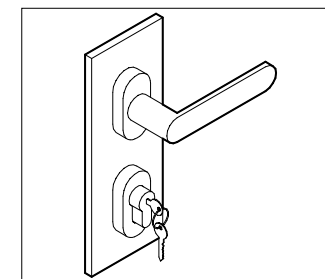

ML8

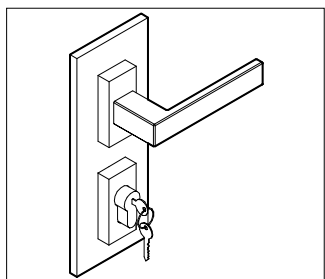

ML9

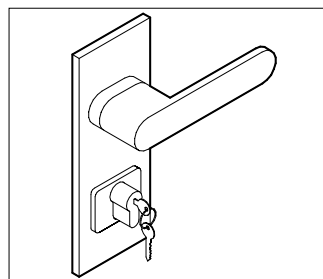

ML10

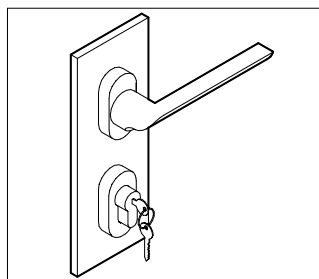

ML11

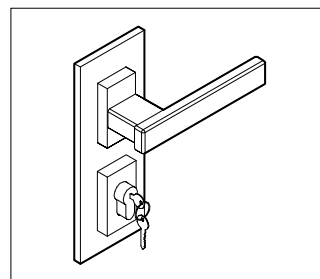

MLQ

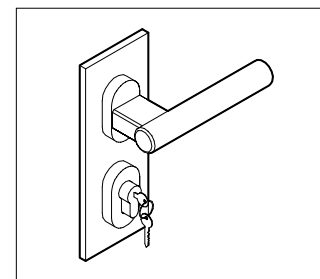

MLT

ANTA INTELAIATA VETRO DOPPIO sp. 51 mm

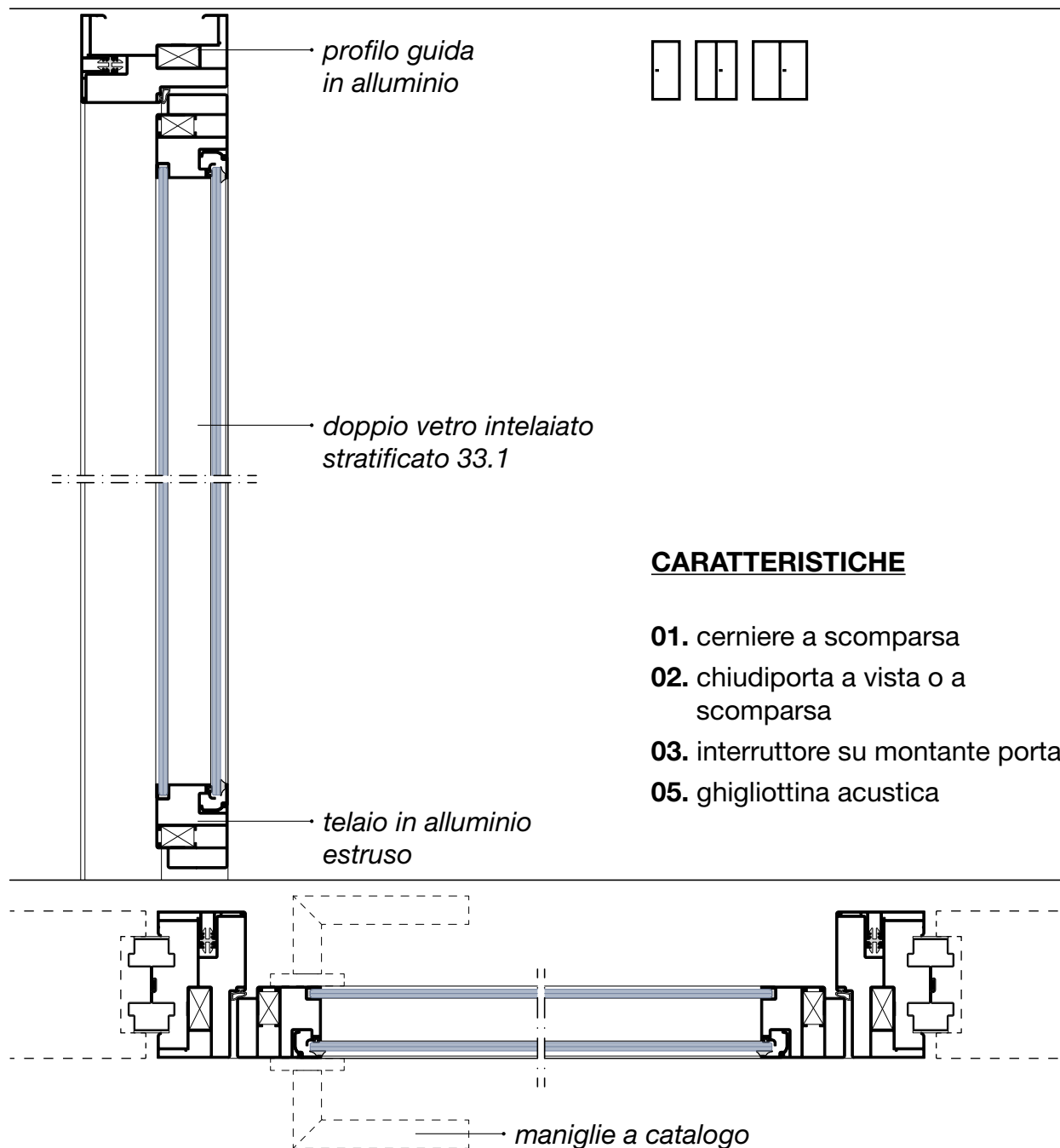

ANTA INTELAIATA VETRO DOPPIO sp. 51 mm

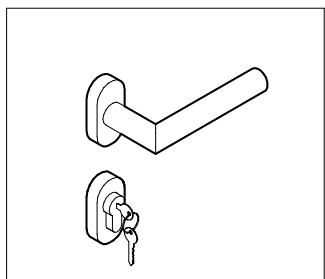

ML5

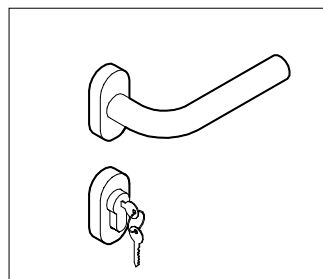

ML6

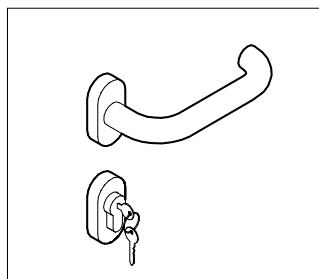

ML7

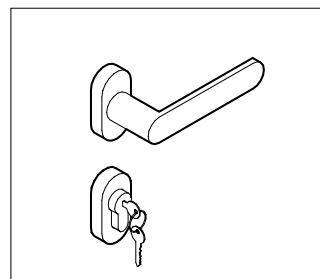

ML8

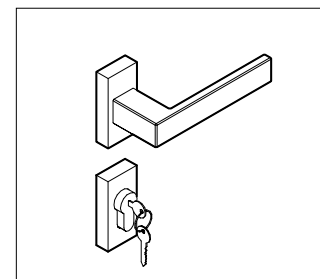

ML9

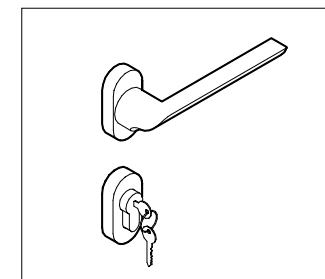

ML11

ANTA INTELAIATA CIECA sp. 104 mm

Porta complanare

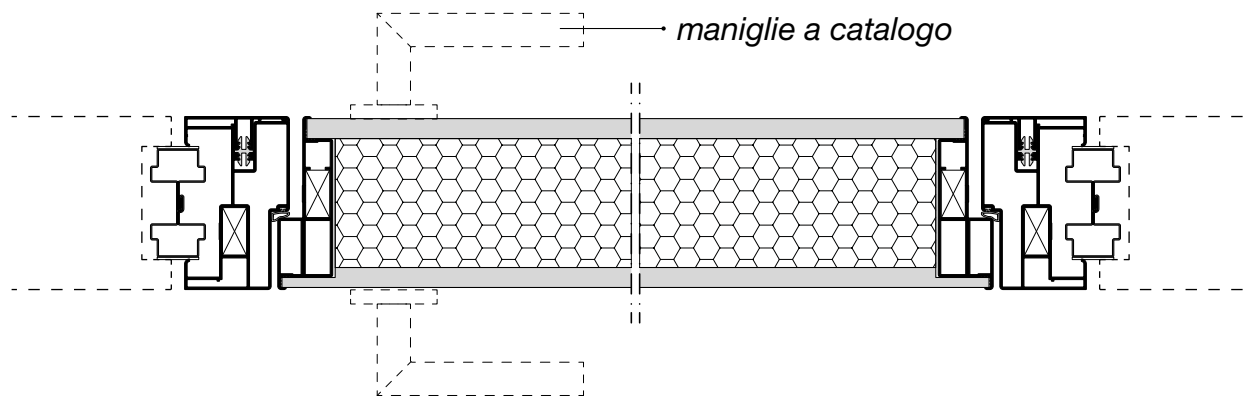
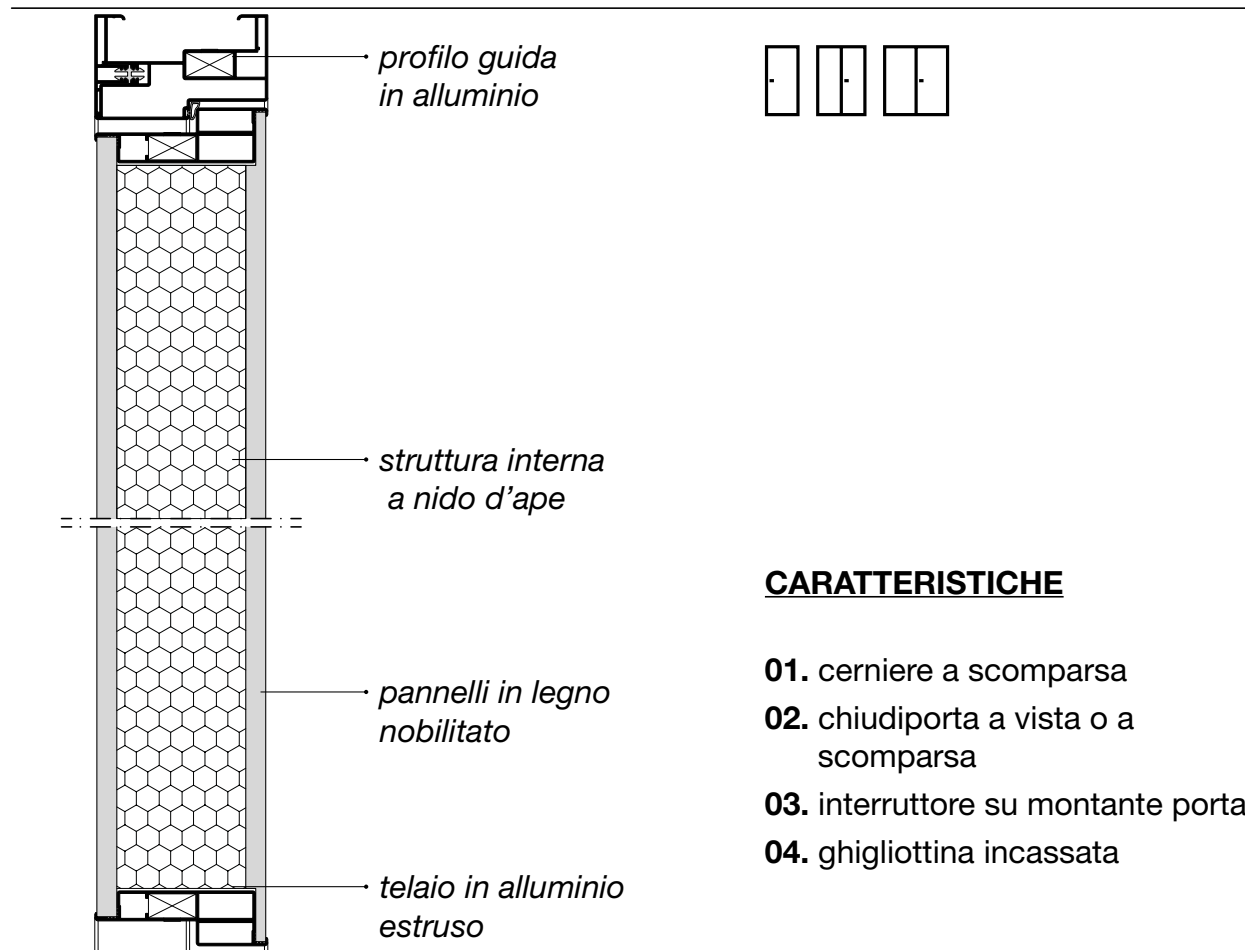

ANTA INTELAIATA CIECA sp. 104 mm

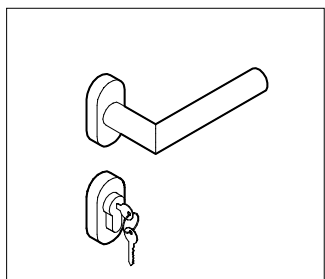

ML5

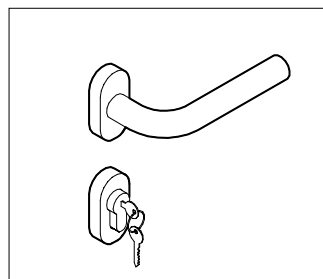

ML6

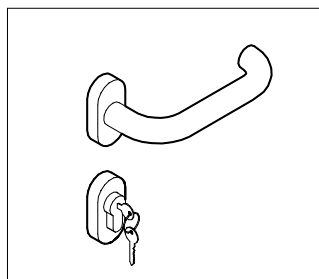

ML7

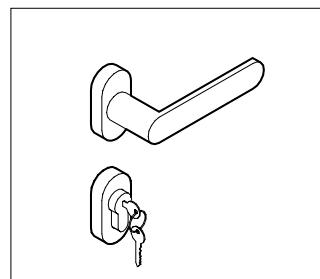

ML8

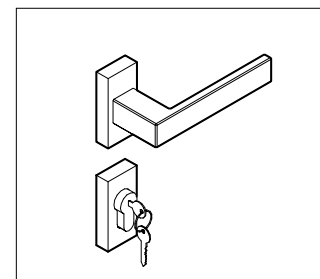

ML9

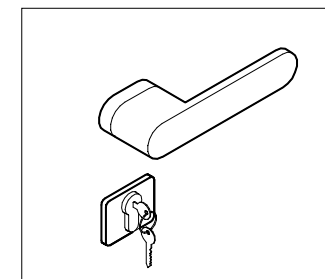

ML10

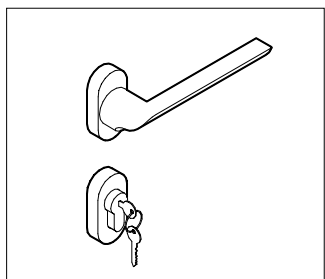

ML11

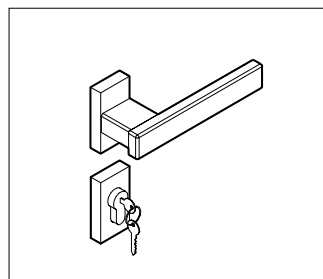

MLQ

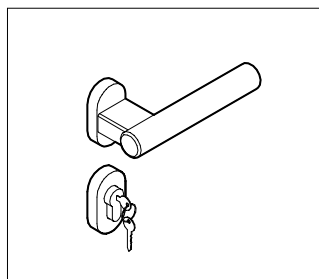

MLT

ANTA INTELAIATA VETRO DOPPIO sp. 104 mm

Porta complanare

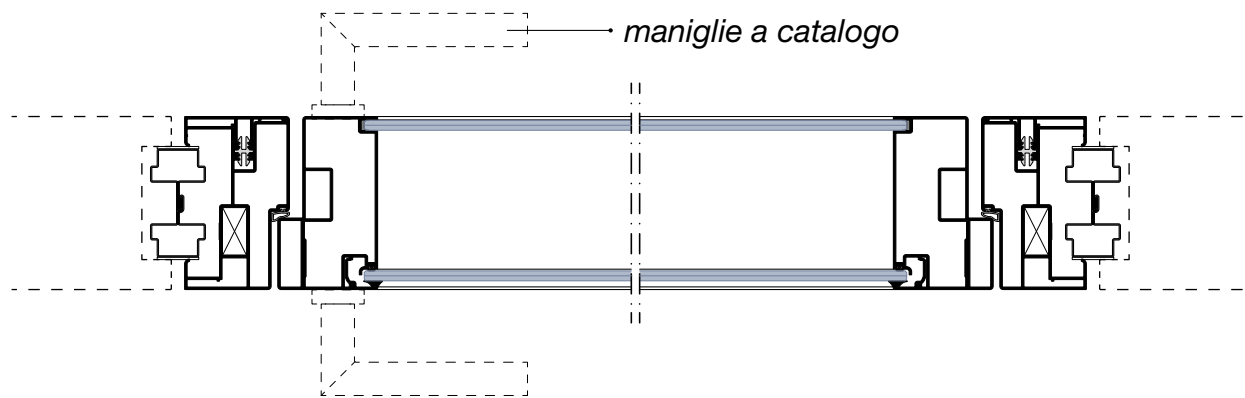
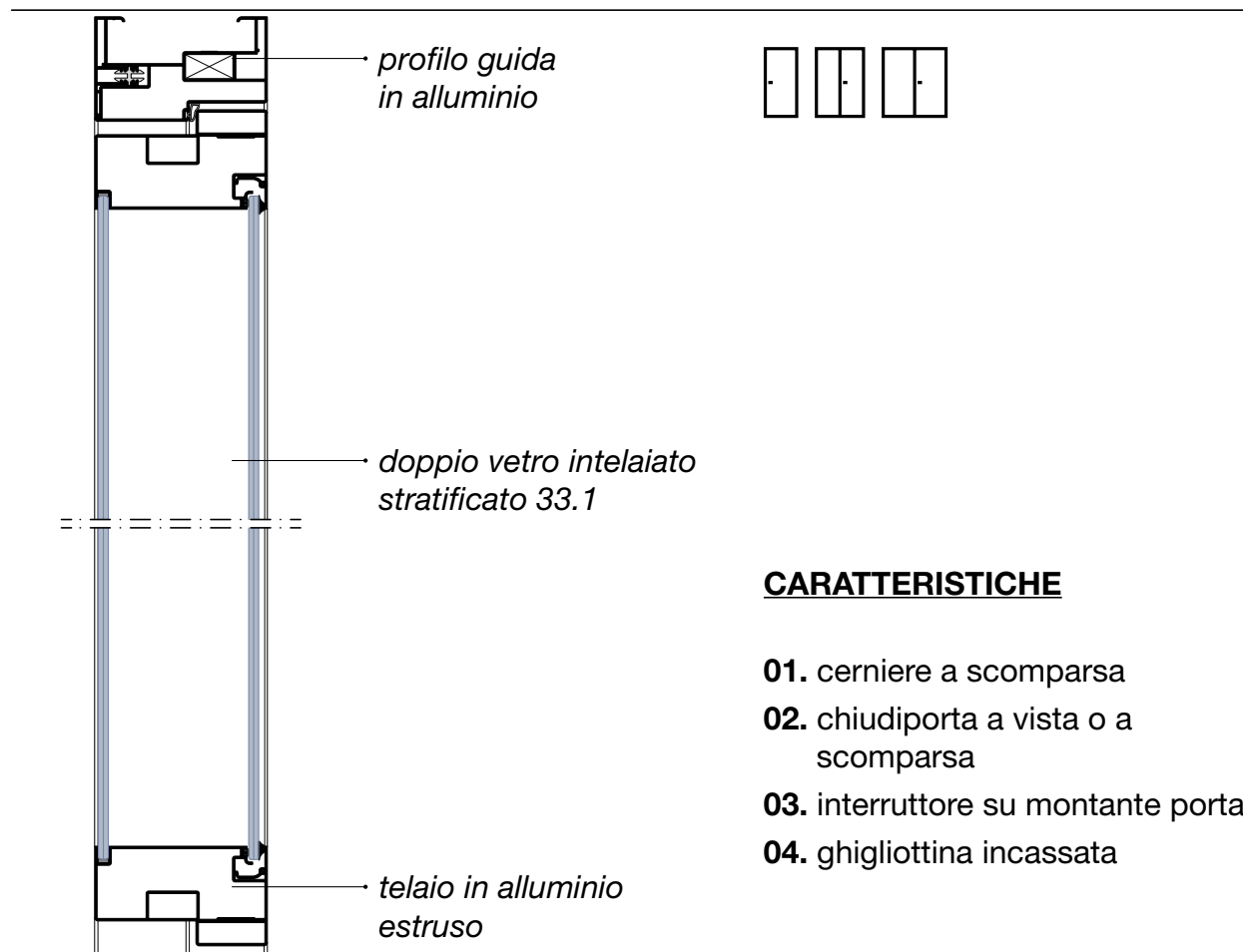

ANTA INTELAIATA VETRO DOPPIO sp. 104 mm

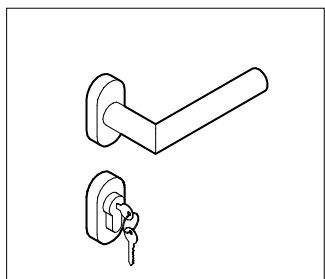

ML5

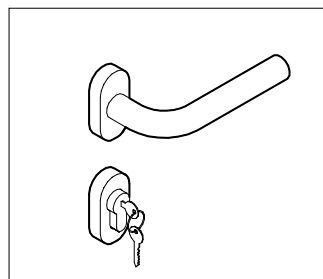

ML6

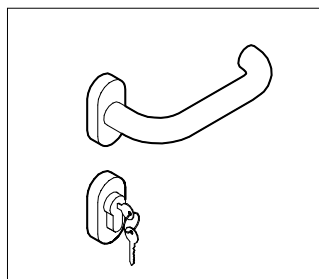

ML7

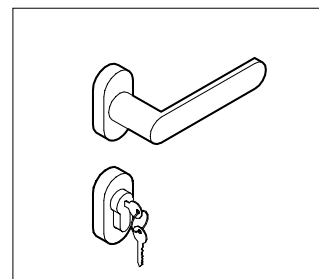

ML8

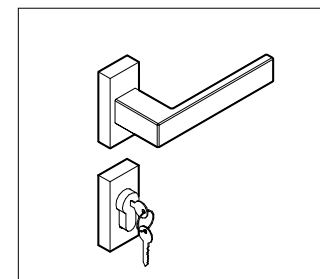

ML9

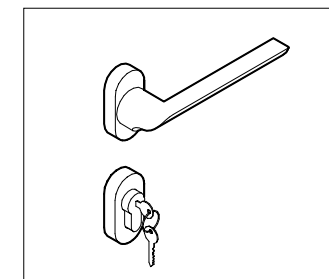

ML11

TELAI PORTE BATTENTI



Telaio porta **Metrica D** su **Metrica R**

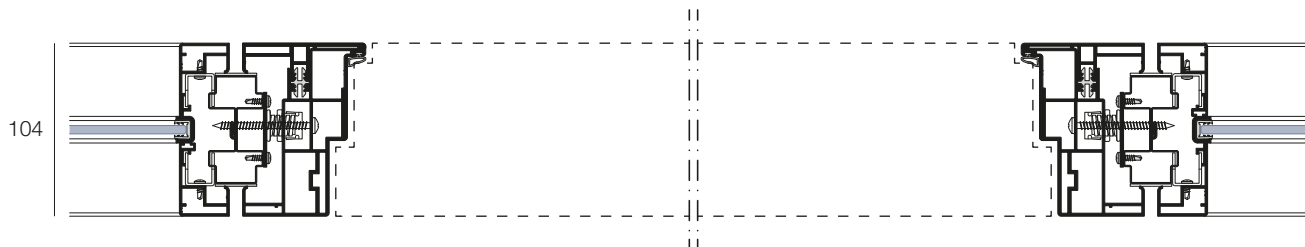

Telaio porta **Metrica D** su **Metrica V**

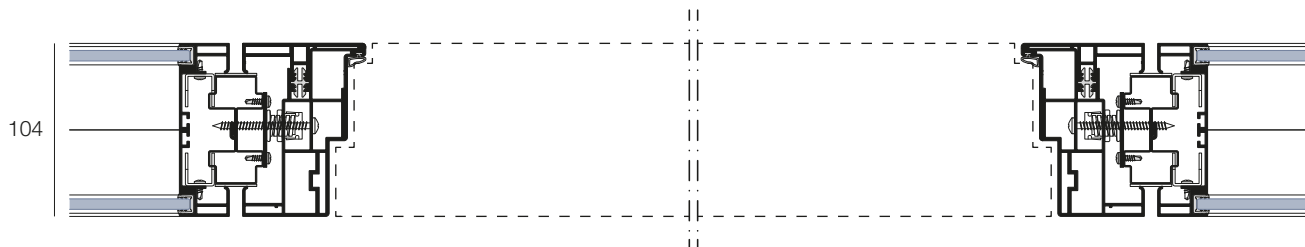

Telaio porta **Metrica D** su **Metrica S**

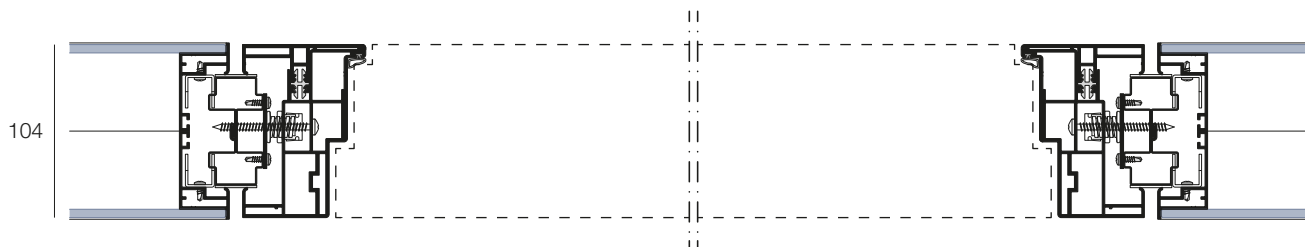

Telaio porta **Metrica D** su **Metrica Solid**

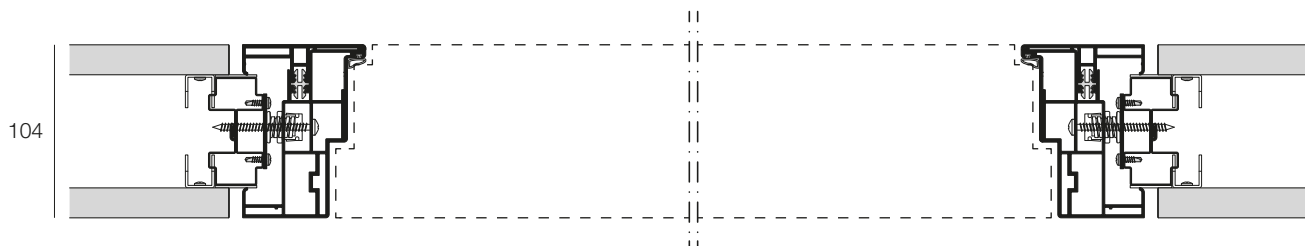

ANTA INTELAIATA CIECA_CON DOPPIA BATTUTA sp. 104 mm



Porta complanare

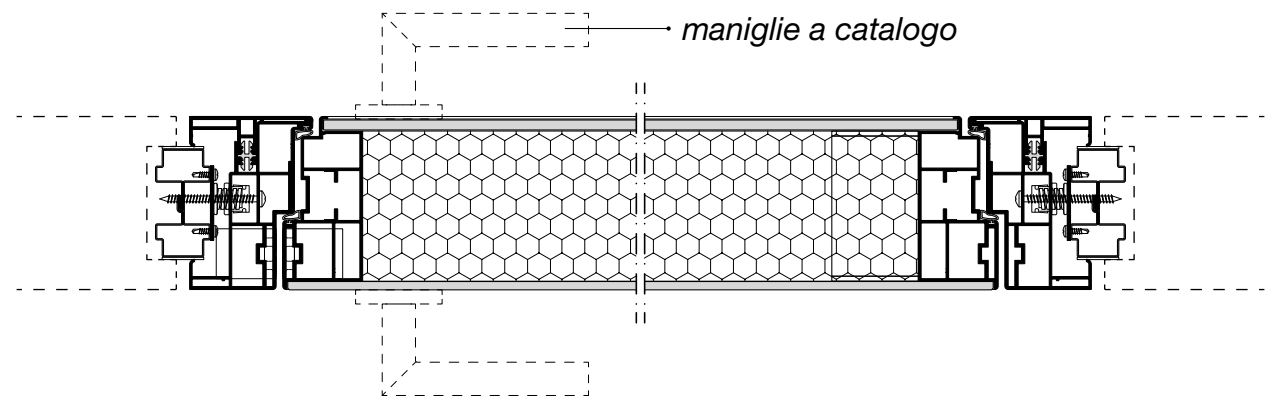
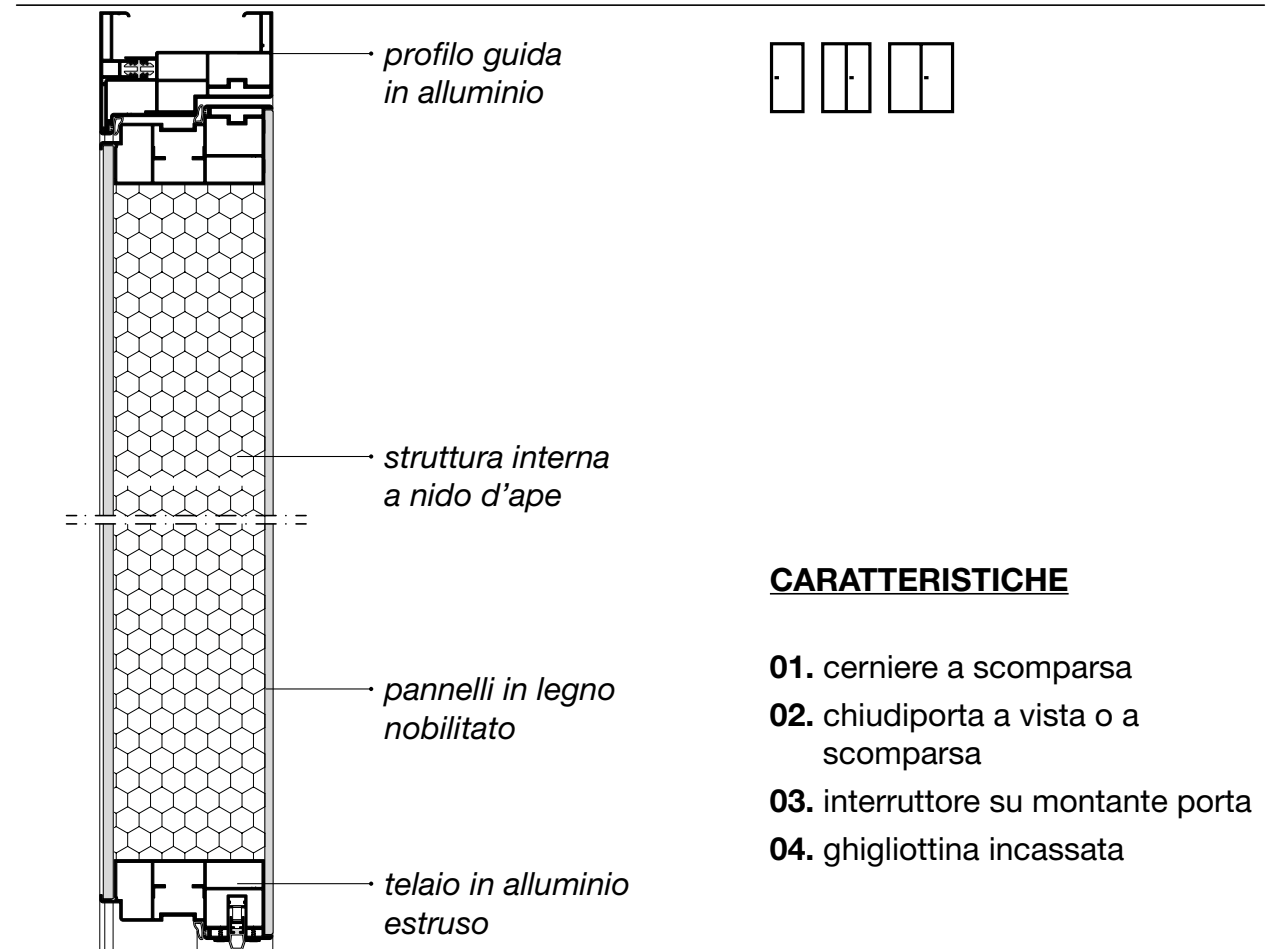

ANTA INTELAIATA CIECA_ CON DOPPIA BATTUTA sp. 104 mm

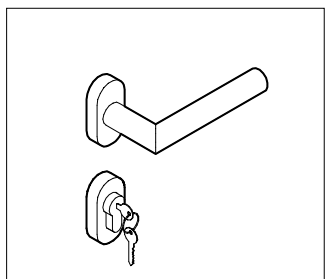

ML5

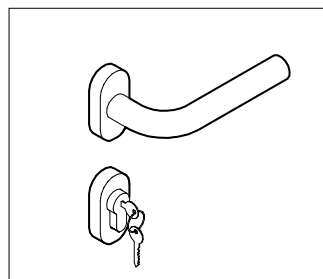

ML6

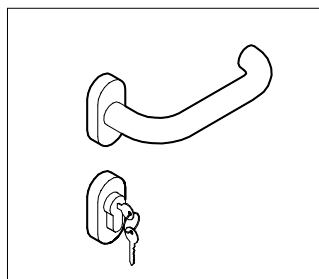

ML7

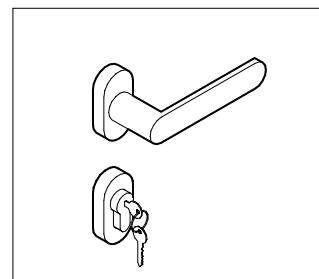

ML8

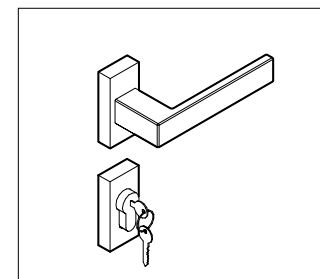

ML9

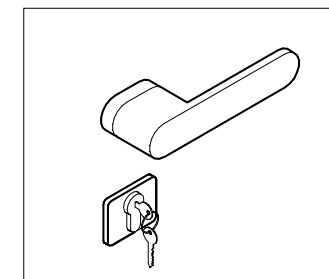

ML10

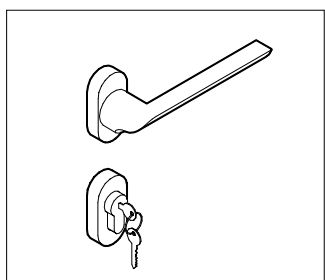

ML11

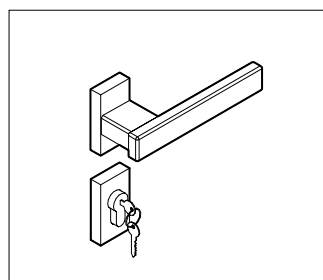

MLQ

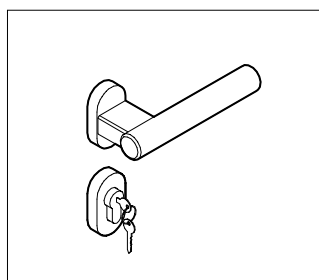

MLT

ANTA INTELAIATA VETRO DOPPIO SERIGRAFATO_CON DOPPIA BATTUTA sp. 104 mm



Porta complanare

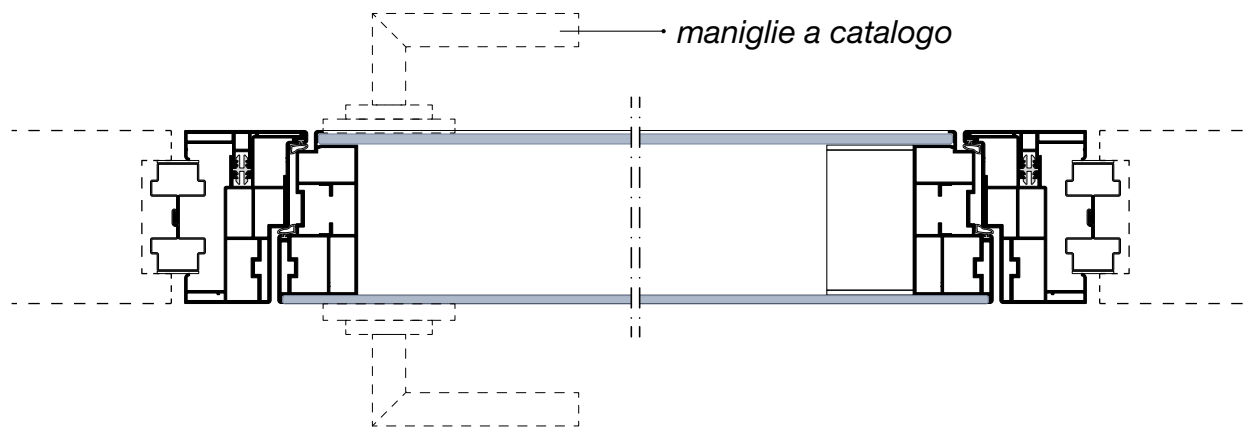
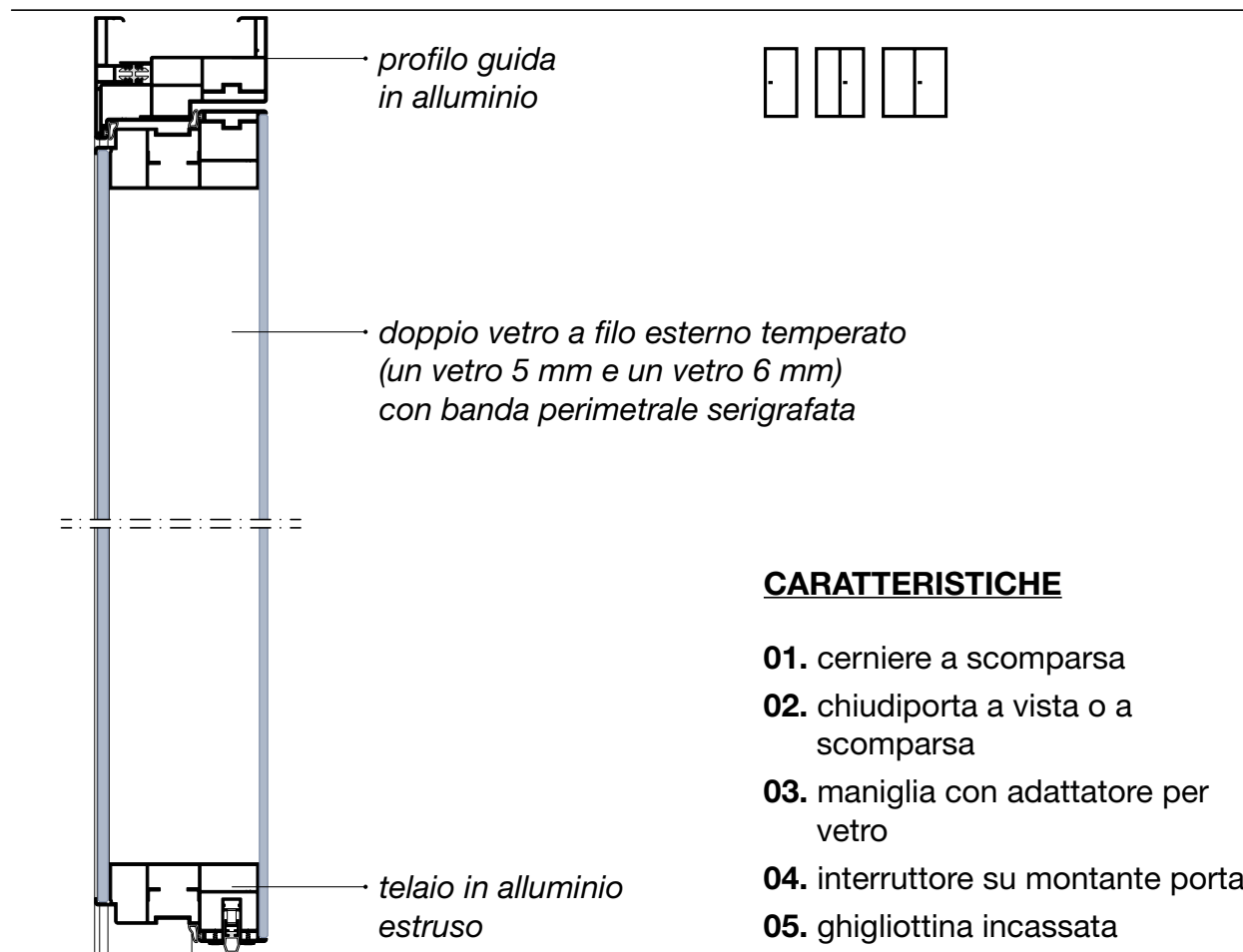

ANTA INTELAIATA VETRO DOPPIO SERIGRAFATO_CON DOPPIA BATTUTA sp. 104 mm

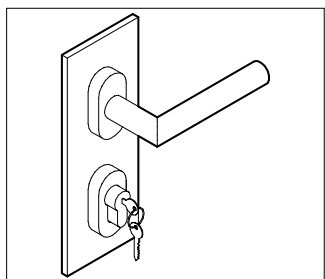

ML5

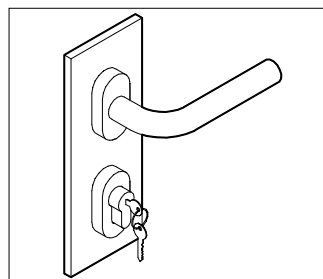

ML6

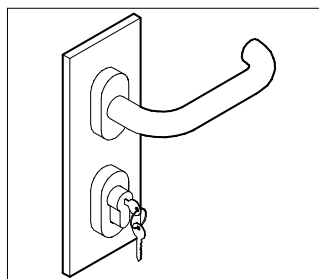

ML7

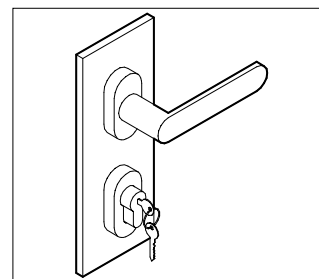

ML8

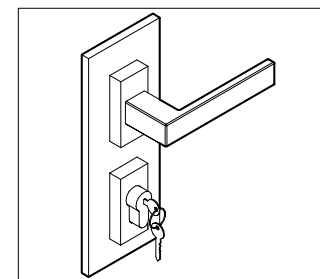

ML9

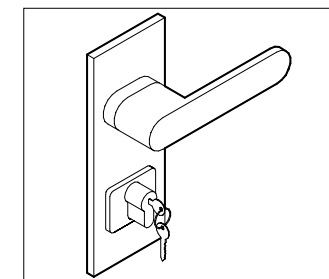

ML10

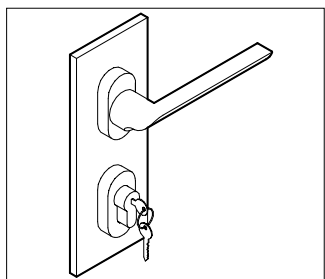

ML11

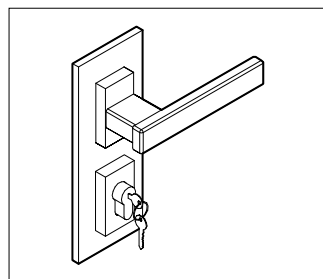

MLQ

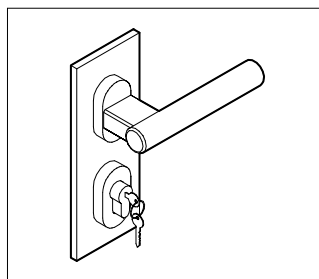

MLT

TELAI PORTE SCORREVOLI



Telaio porta su **Metrica R**

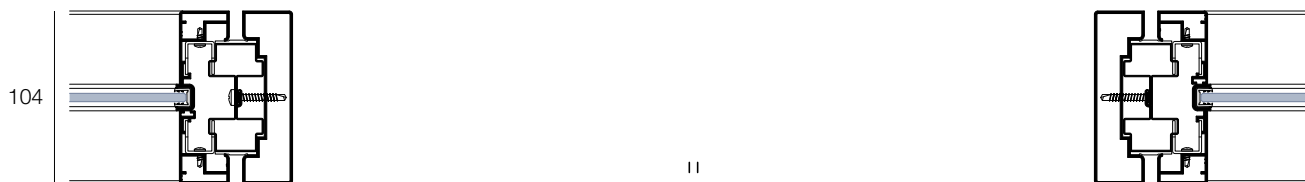

Telaio porta su **Metrica V**

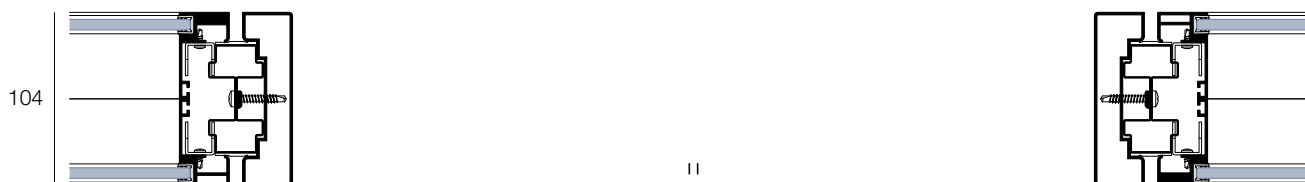

Telaio porta su **Metrica S**

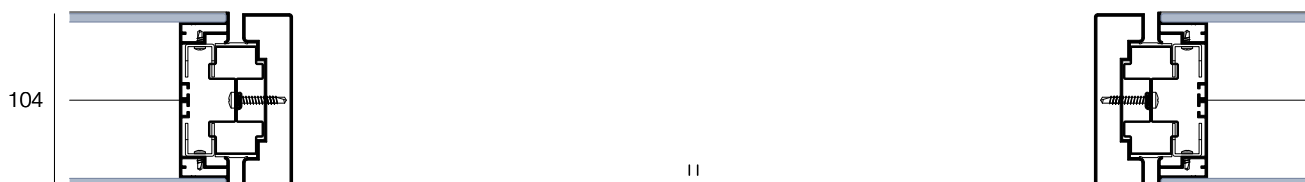

Telaio porta su **Metrica Solid**

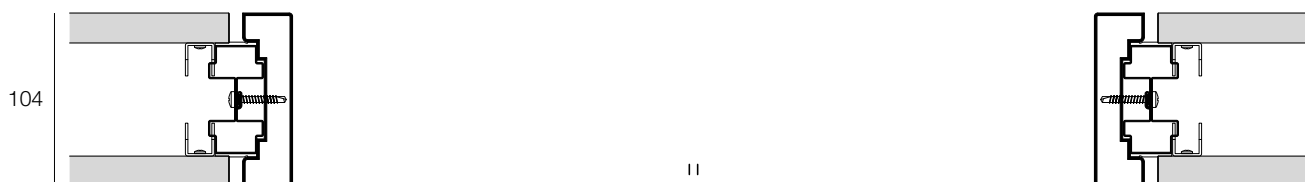

* Connessione del telaio della porta scorrevole sulle varie pareti metrica

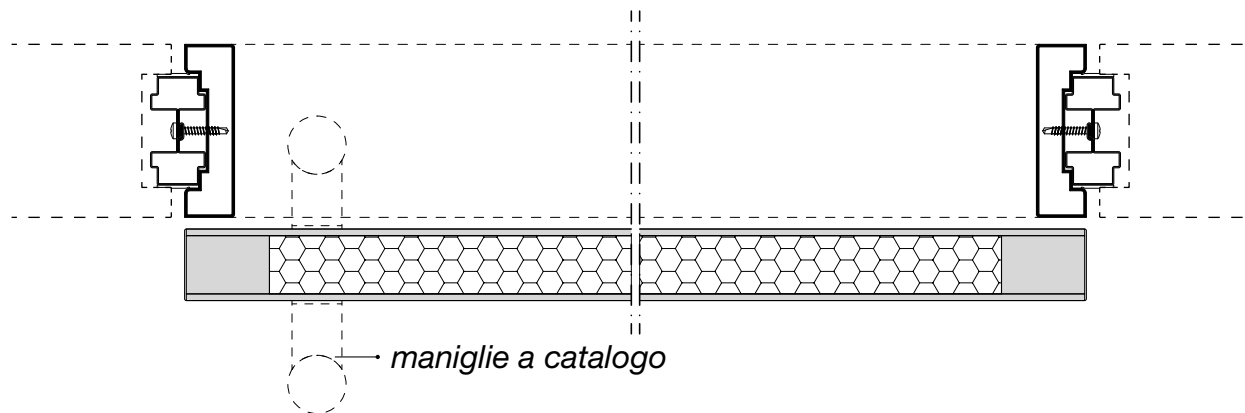
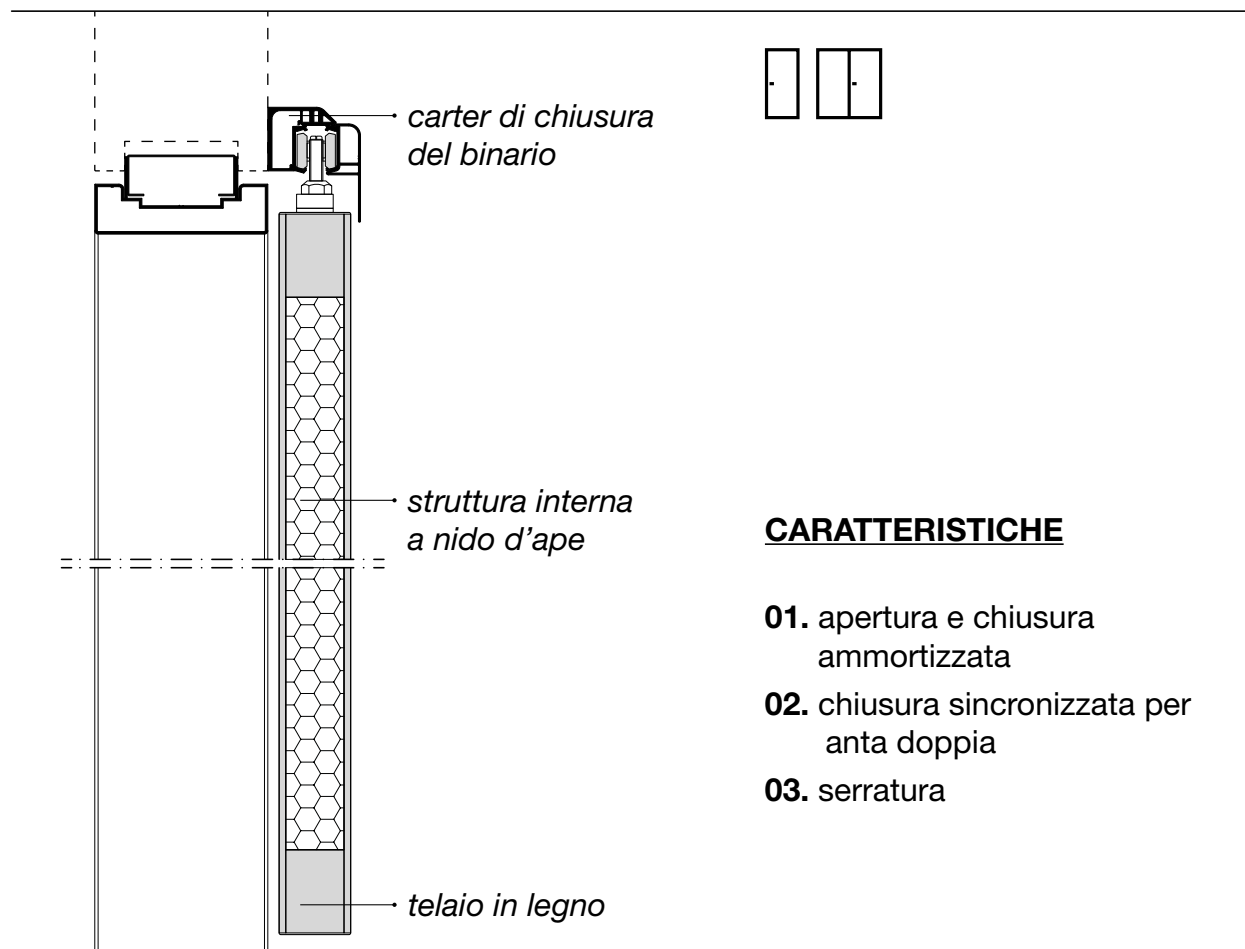

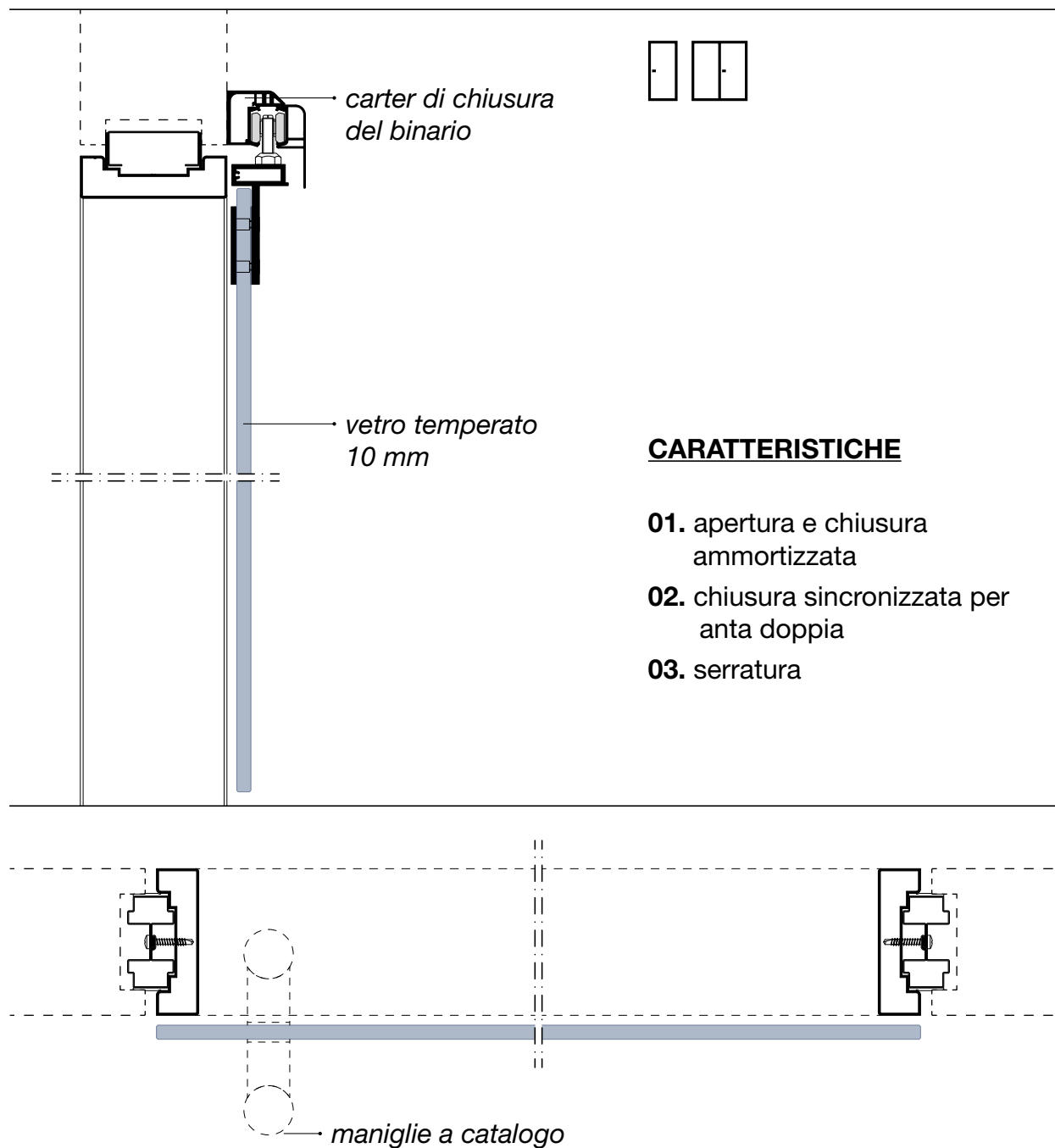

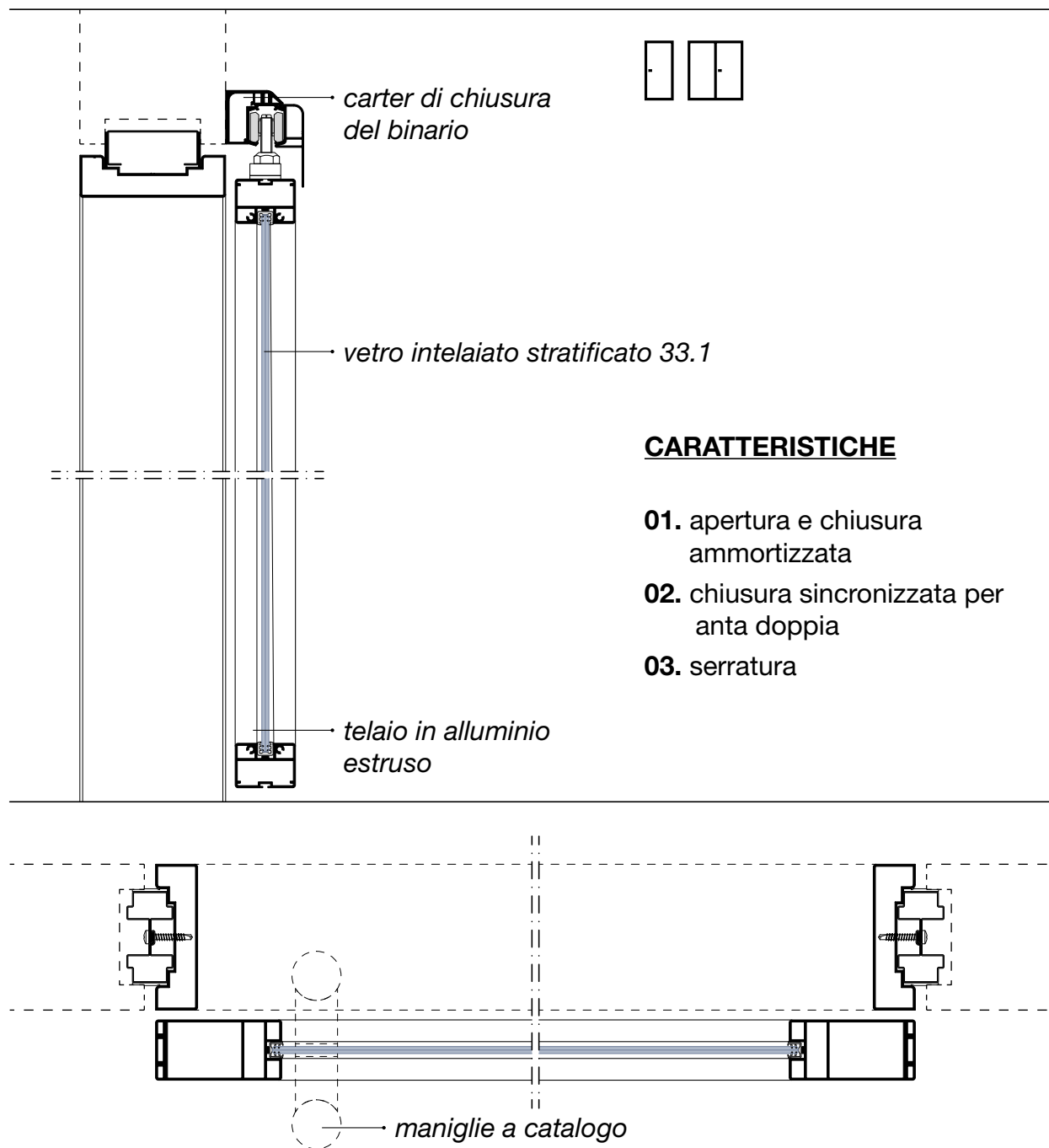

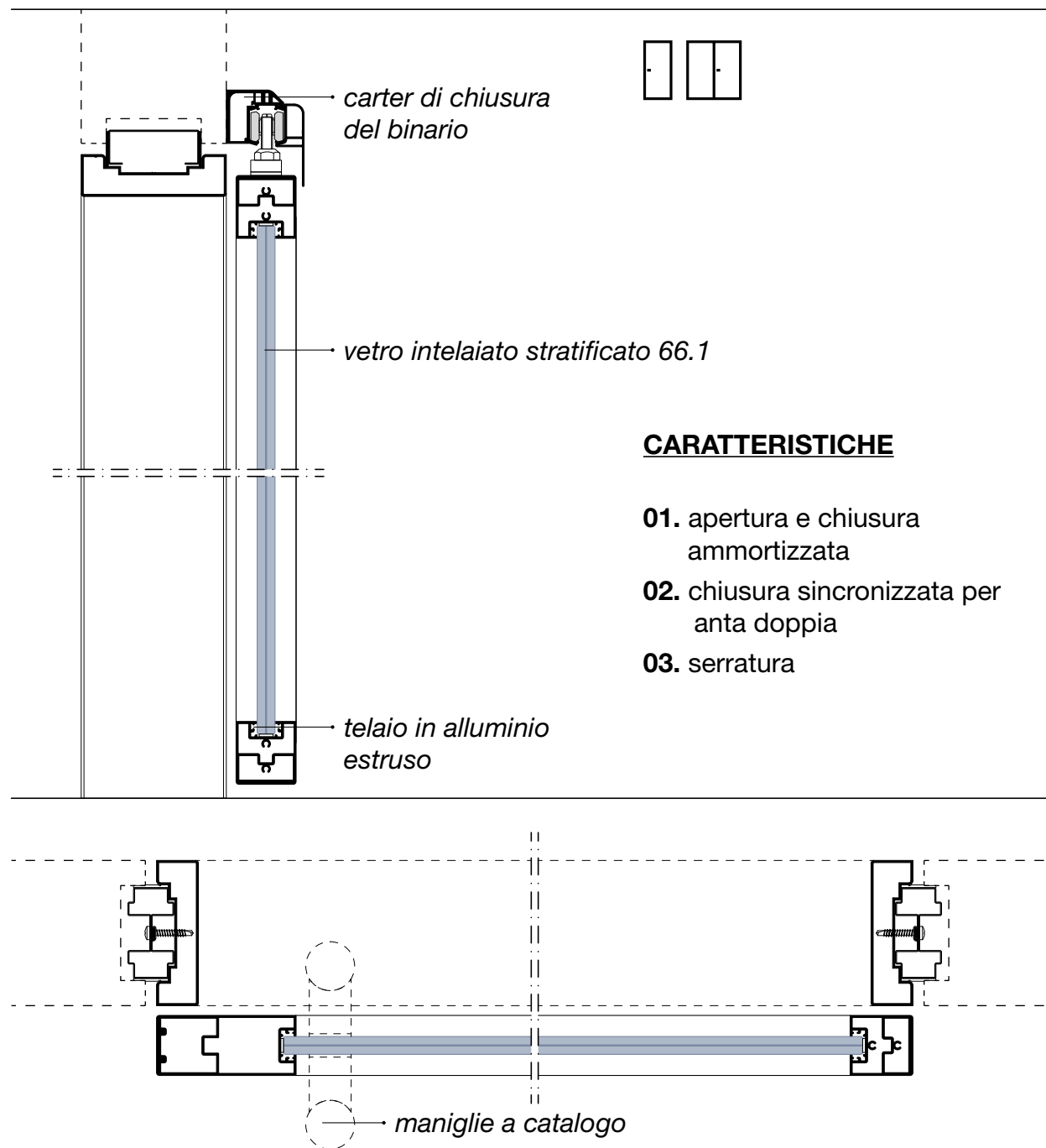

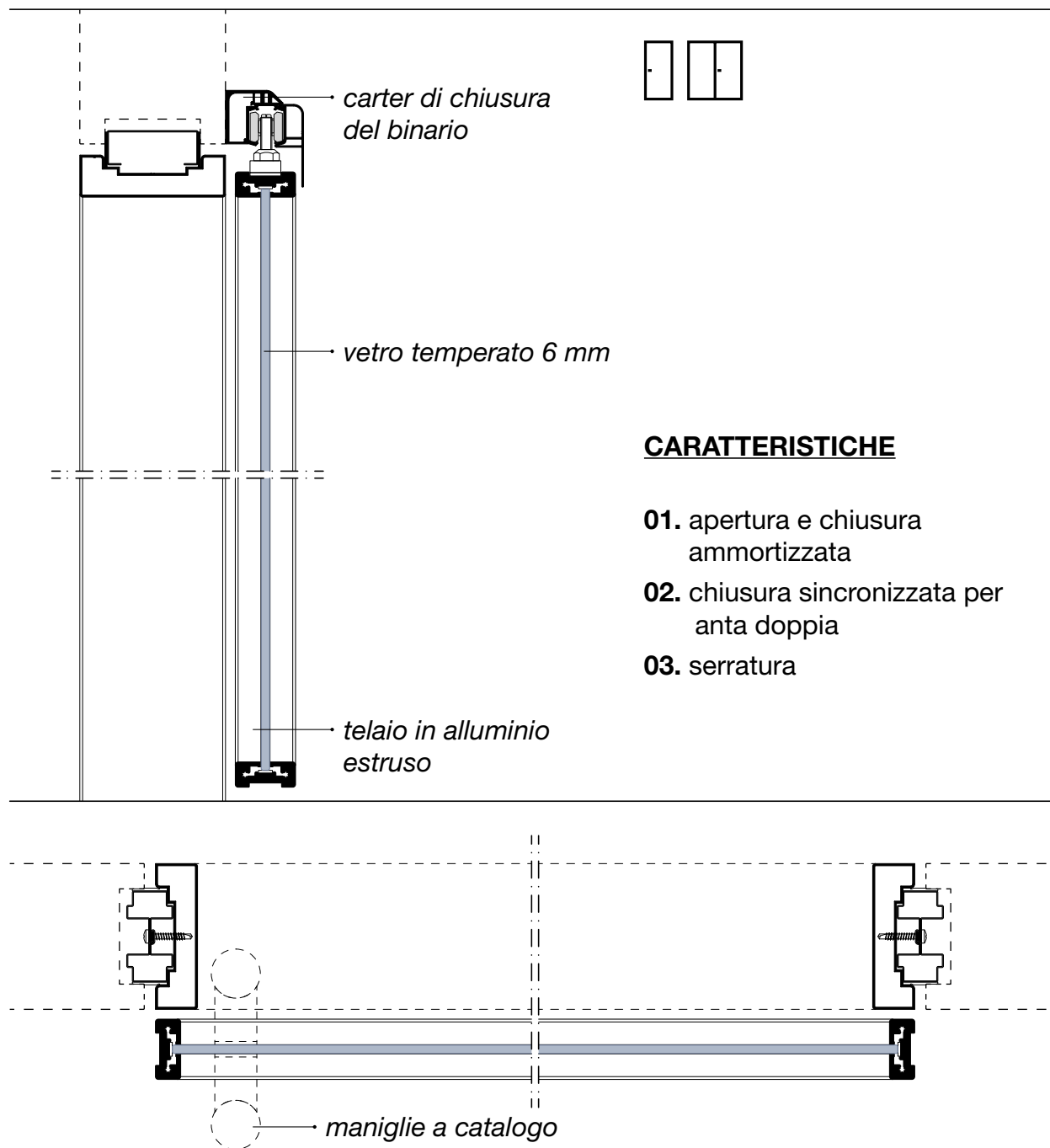

ANTA CIECA_SCORREVOLE INTERNA sp. 38 mm

*solo per Metrica Solid

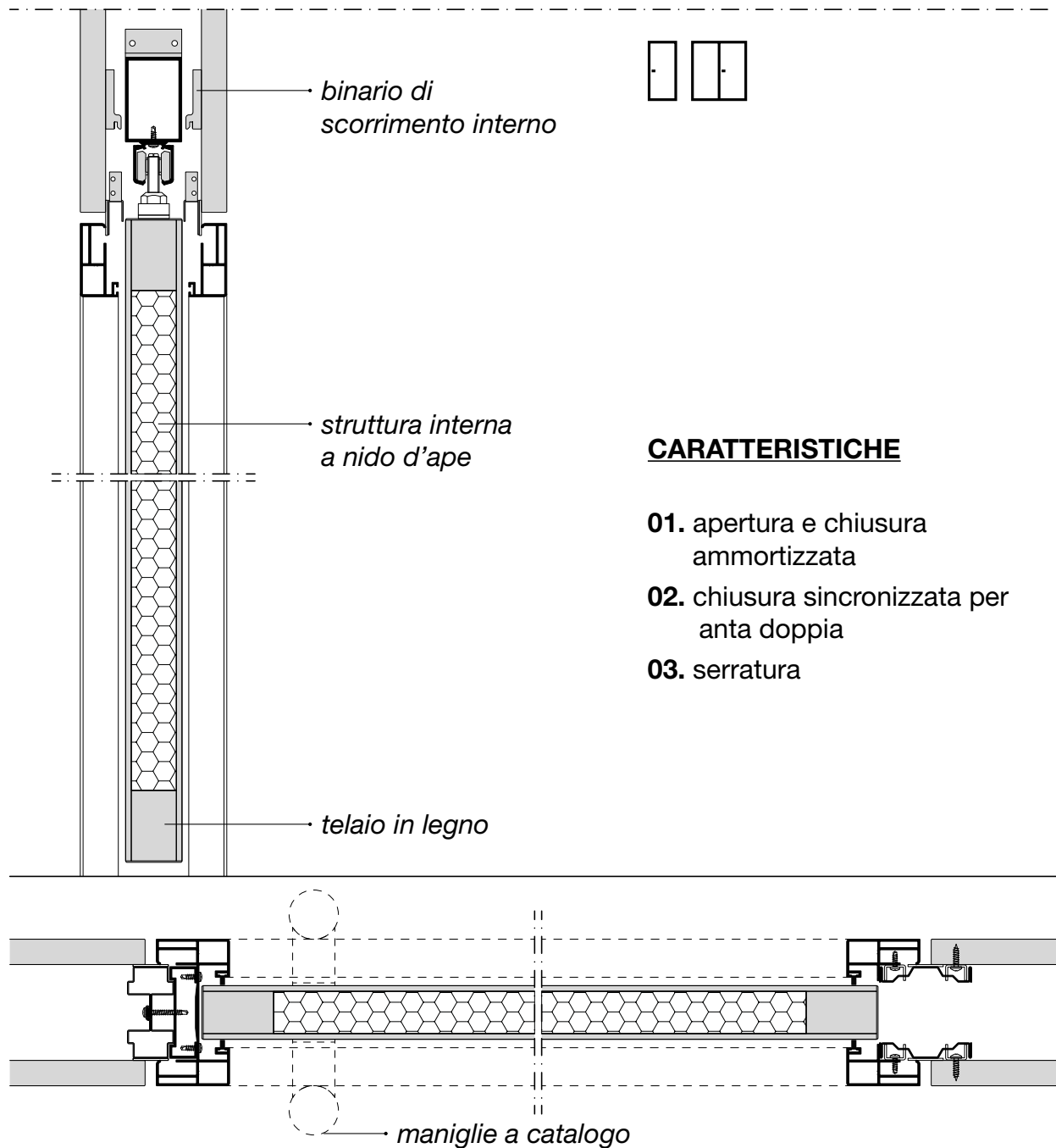

ANTA VETRO TEMPERATO_SCORREVOLE INTERNA sp. 10 mm

*solo per Metrica Solid

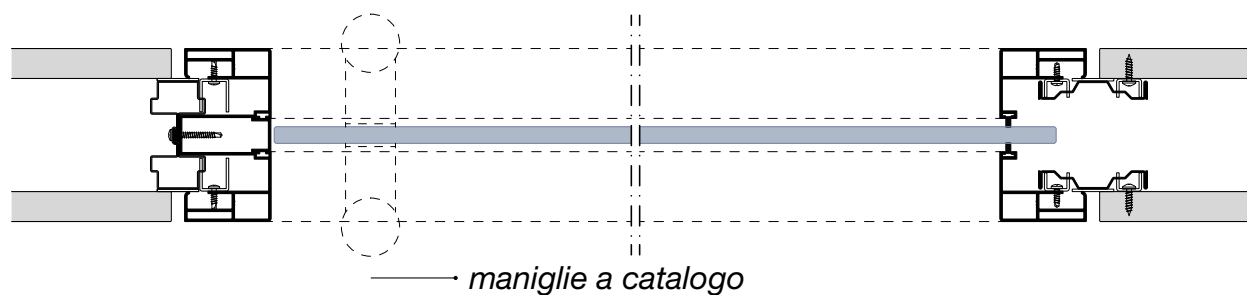
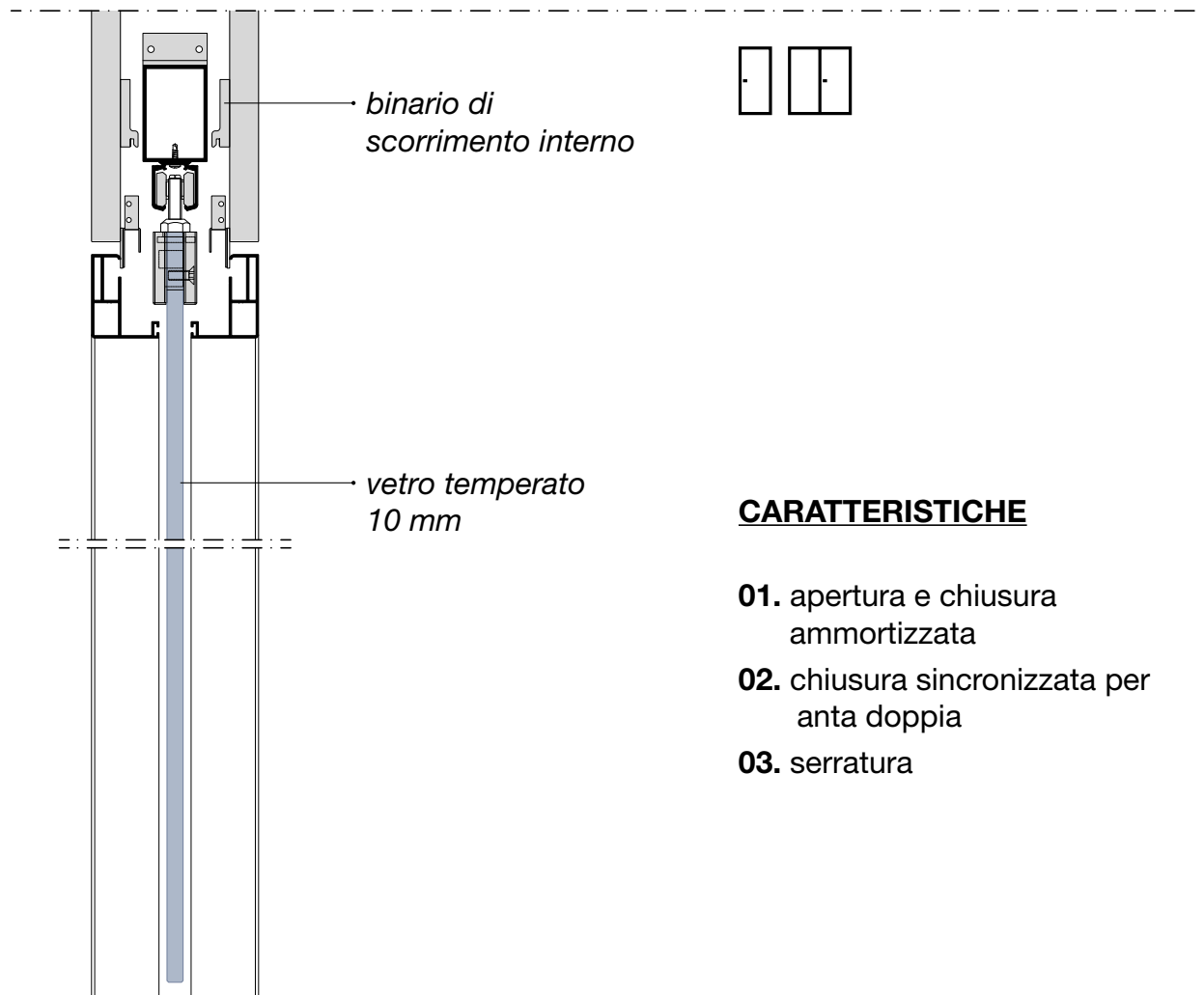

Porte in vetro



ACCIAIO

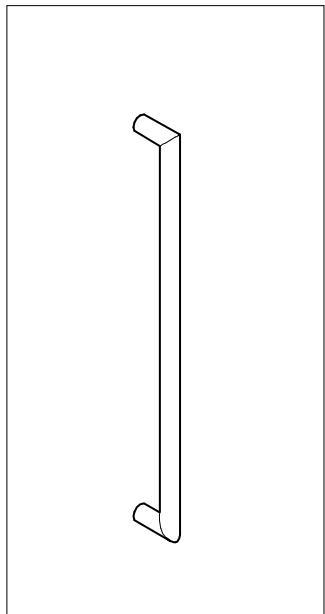

MPOMGH1_H2_H3

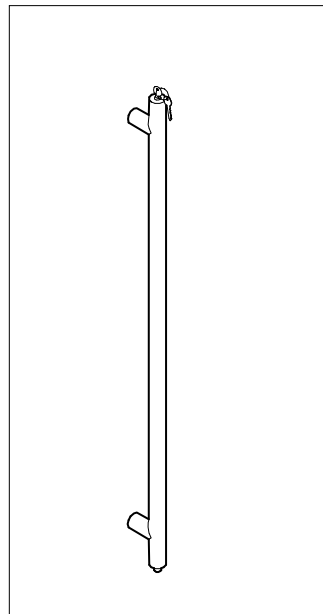

MPOM2

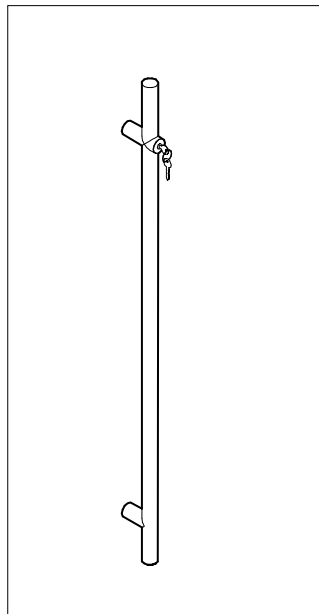

MPOM3

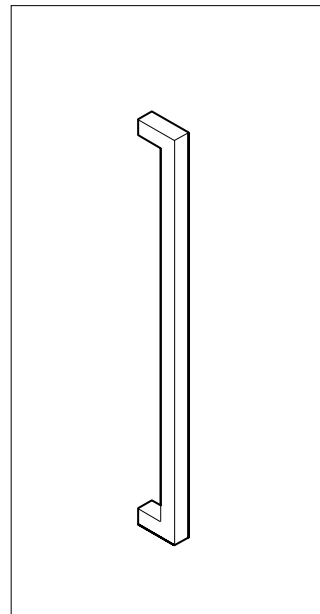

MPOMGH1Q_GH2Q_GH3Q

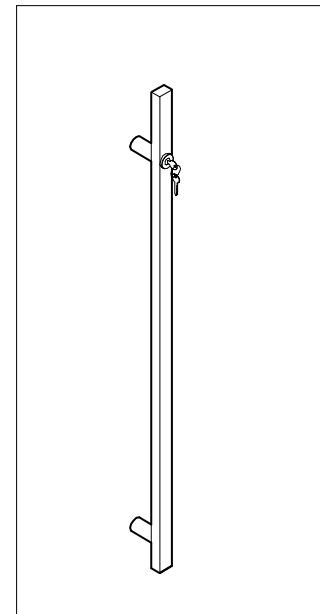

MPOM3Q

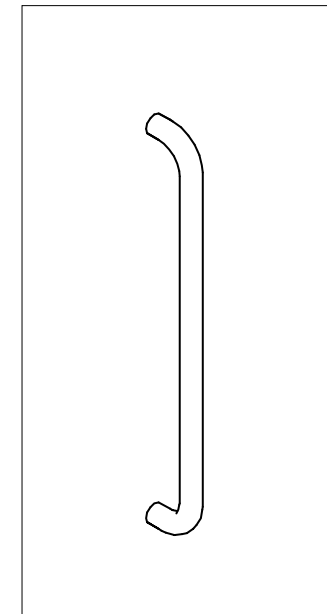

MPOM8

ALLUMINIO

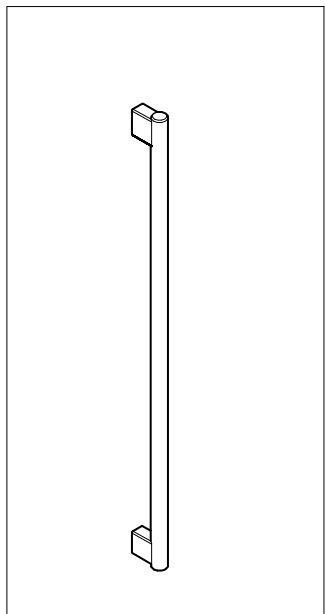

MPOMTH1_TH2

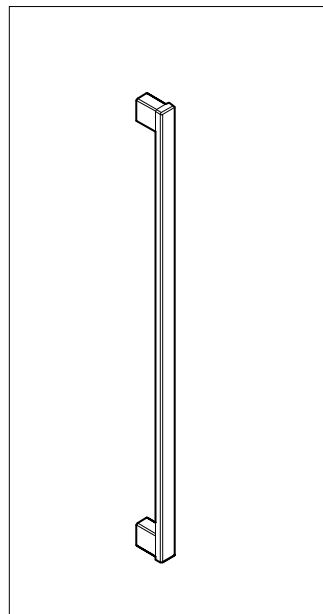

MPOMQH1_QH2

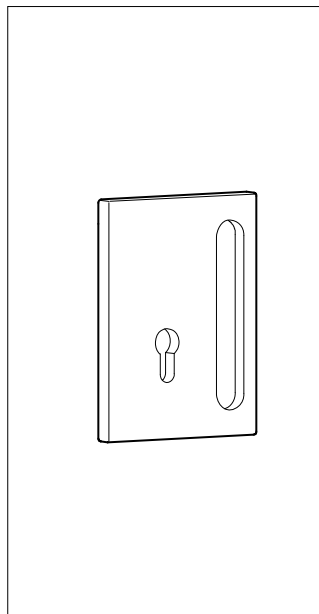

MPOM6

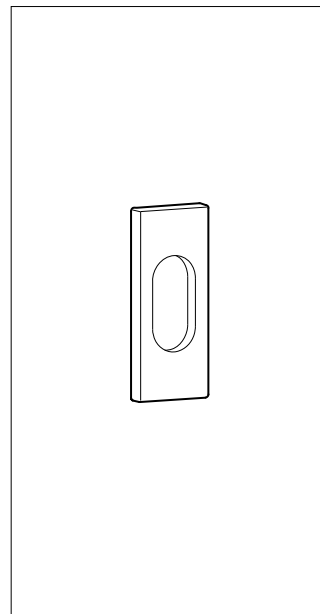

MPOM7



Porte cieche

ACCIAIO

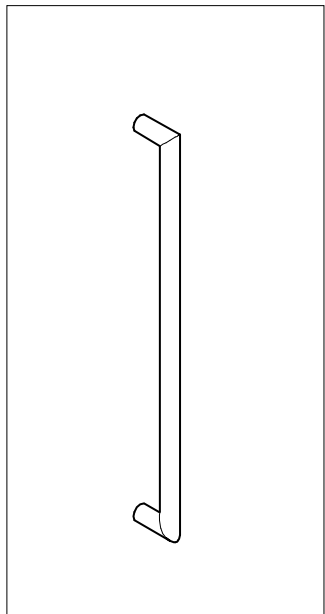

MPOMGH1_H2_H3

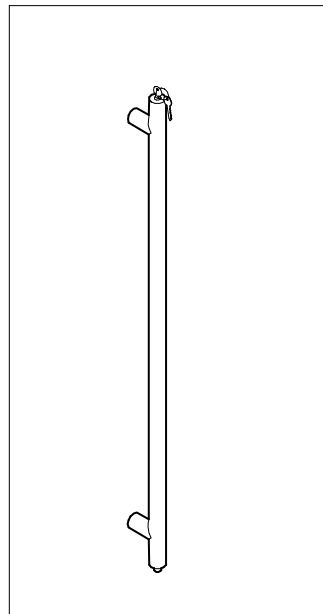

MPOM2

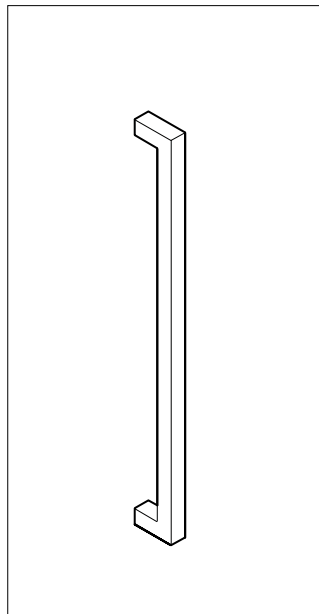

MPOMGH1Q_GH2Q_GH3Q

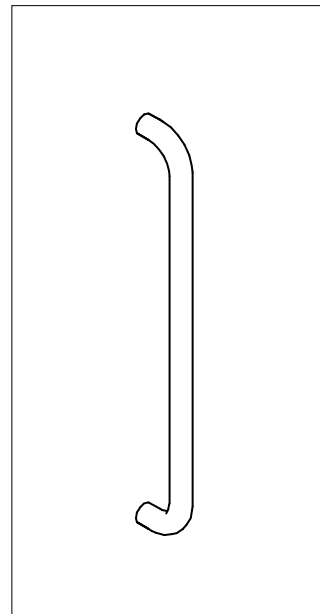

MPOM8

ALLUMINIO

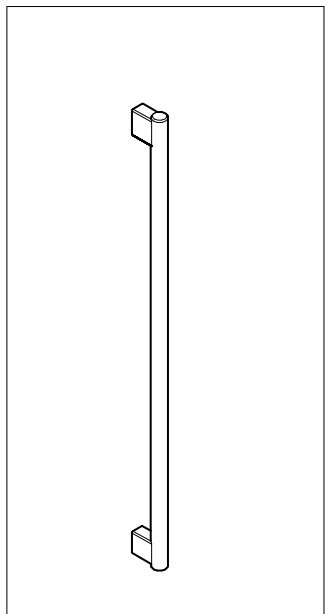

MPOMTH1_TH2

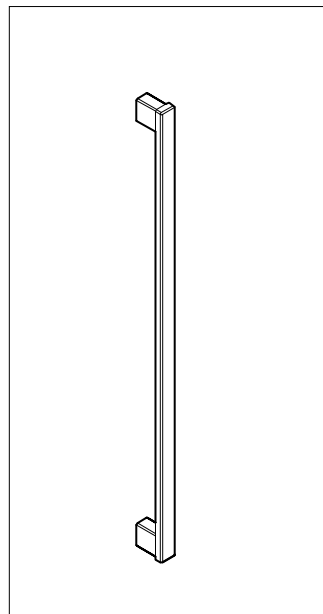

MPOMQH1_QH2

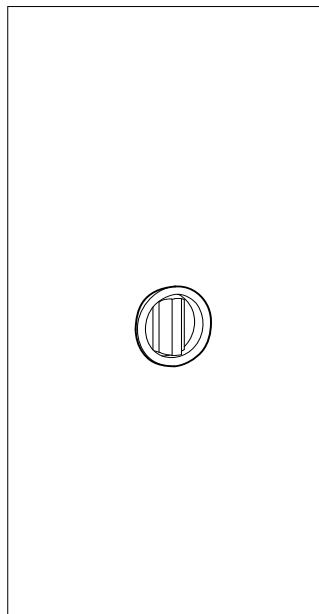

MPOM4

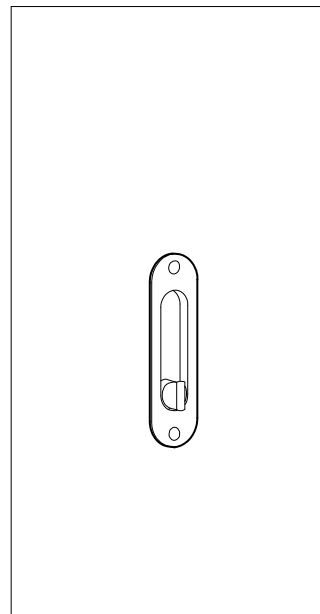

MPOM5

METRICA[®]
STRUTTURALE

Accessori



Chiudiporta aerei

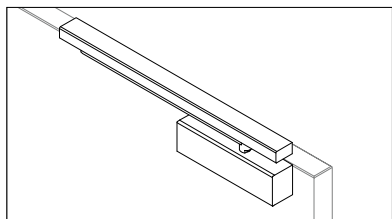

01 esterno a slitta
per anta cieca/intelaiata

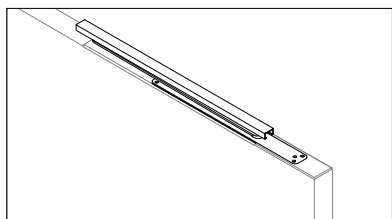

02 a scomparsa
per anta cieca/intelaiata

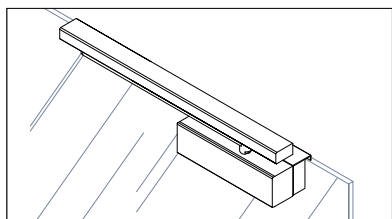

03 esterno a slitta con supporto
per anta in vetro temperato

Chiudiporta a terra

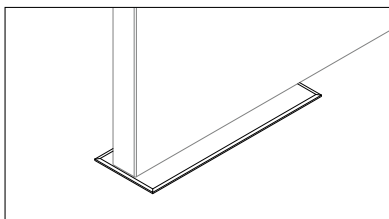

01 a pavimento
per anta cieca

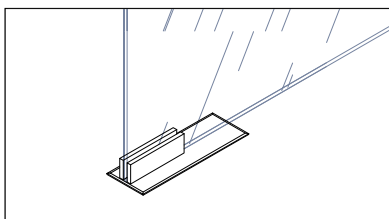

02 a pavimento
per anta in vetro temperato

Cerniere in alluminio

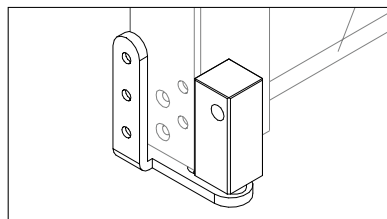

01 a bilico esterno
per anta cieca/intelaiata

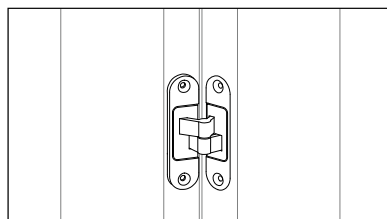

02 a scomparsa
per anta cieca/intelaiata

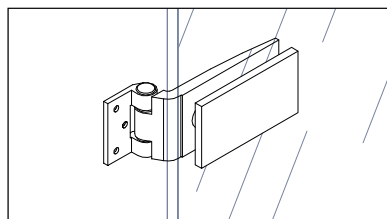

03 apertura 180°
per anta in vetro temperato

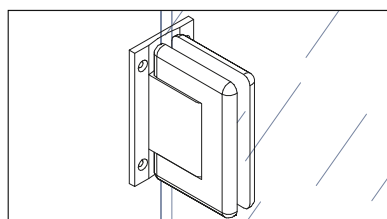

04 va e vieni velocità regolabile
per anta in vetro temperato

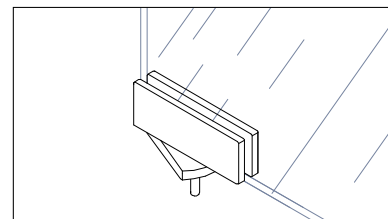

05 va e vieni velocità regolabile
per anta in vetro temperato

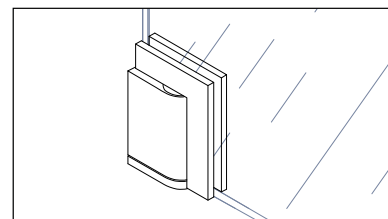

06 va e vieni velocità regolabile
per anta in vetro temperato

Accessori

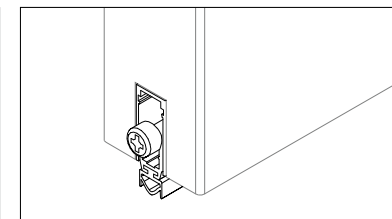

01 Antispiffero insonorizzante
per anta cieca/intelaiata

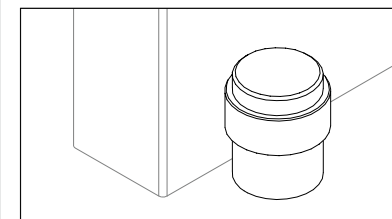

02 Fermaporte
per anta cieca/intelaiata/temperato

METRICA[®]
STRUTTURALE

Finiture



Anodizzati



01 Alluminio naturale

Finiture RAL



01 Bianco



02 Bronzo

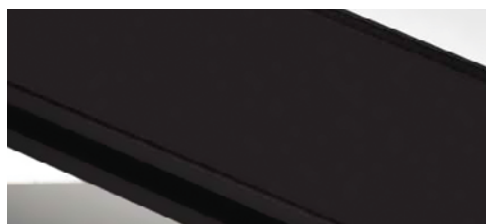

02 Nero

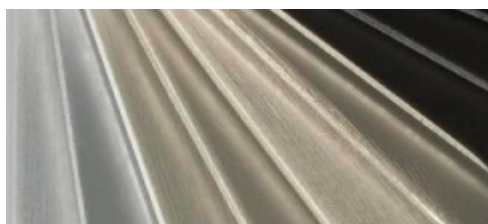

03 Colore a campione



03 Colore a campione

Lucidatura

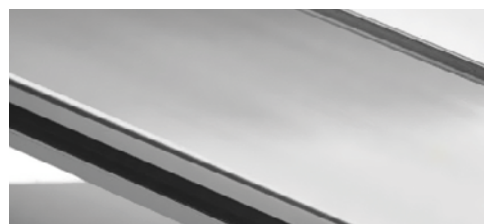

01 Brillantato

Legni



01 Rovere chiaro

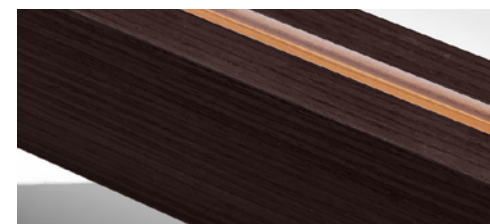

02 Rovere scuro

Pannelli ciechi



CAT. 1

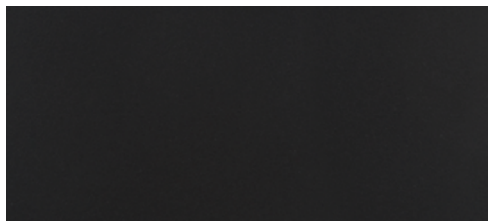

055 Nero grafite

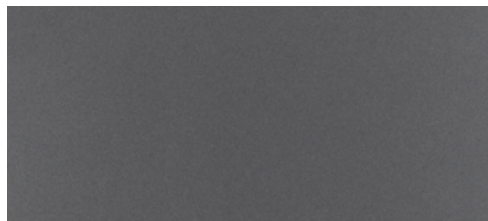

420 Piombo



418 Grigio cenere

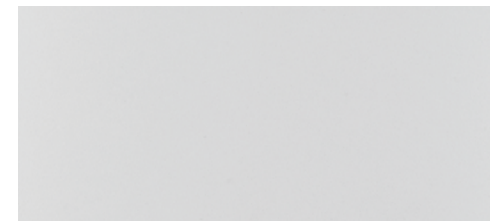

419 Grigio chiaro

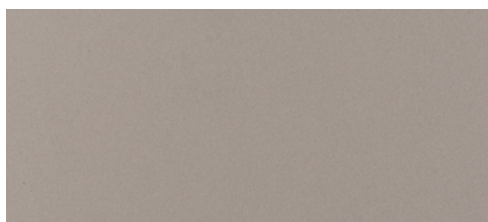

393 Tortora



417 Vaniglia

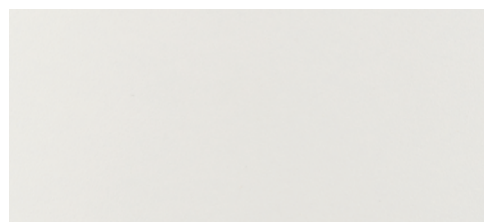

429 Bianco caldo

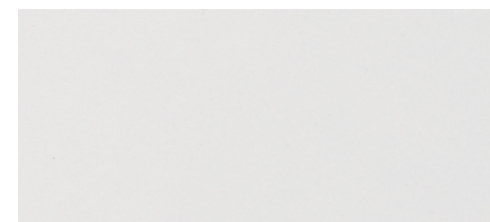

428 Bianco freddo

CAT. 2



422 Argento

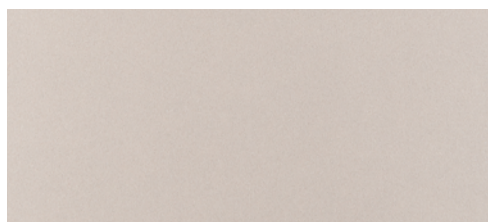

423 Champagne

Legni



CAT. 1

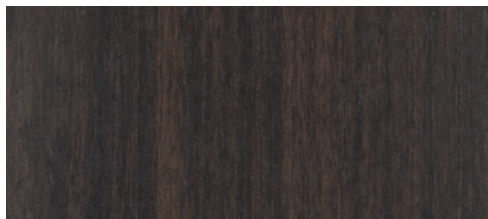

421 Eucalipto

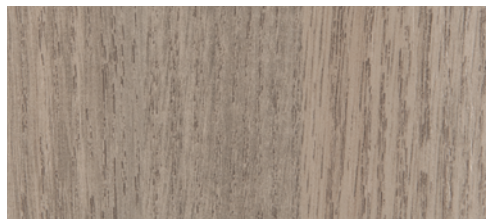

426 Rovere medio



274 Acacia

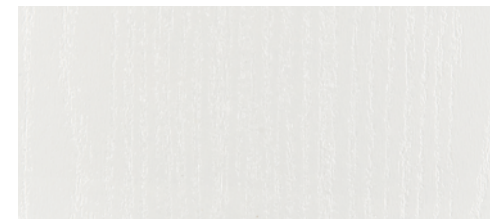

416 Bianco venato

CAT. 2

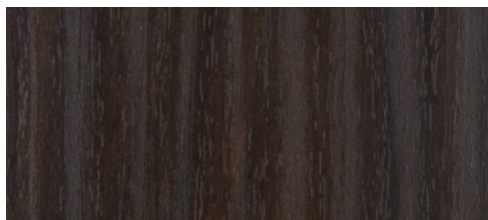

425 Noce scuro

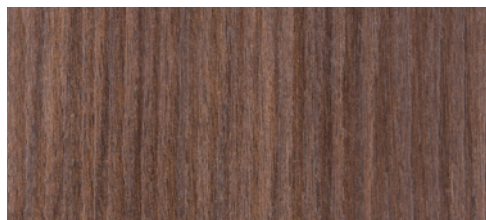

318 Noce medio

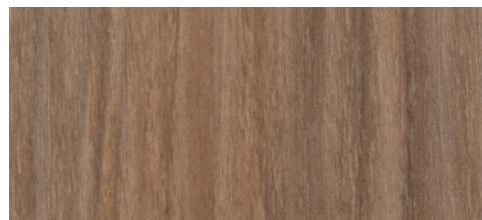

427 Noce chiaro

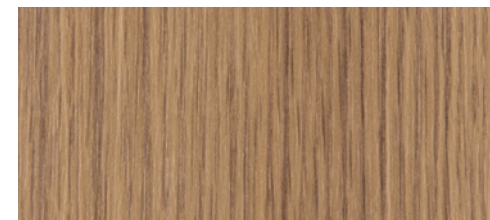

382 Rovere naturale

CAT. 3



138 Rovere invecchiato - taglio seta

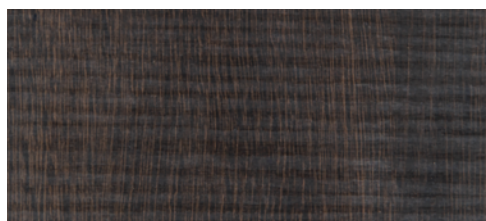

197 Eucalipto - taglio seta

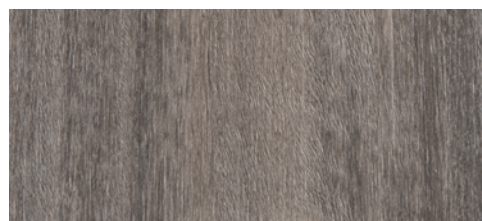

408 Rovere grigio

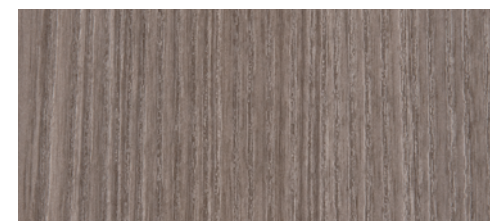

400 Rovere Danubio

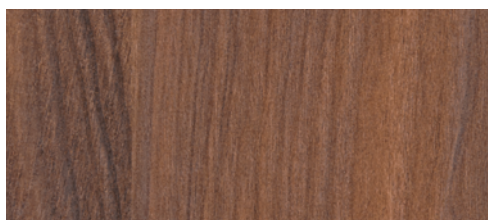

414 Noce rosso

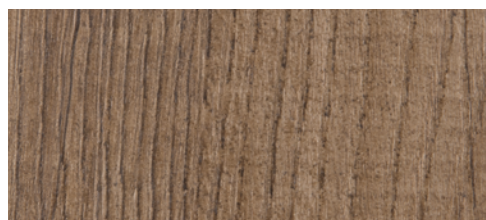

412 Rovere vintage



413 Rovere champagne



410 Rovere chiaro

Materici



CAT. 2

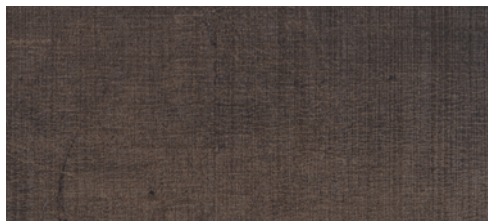

304 Tessuto scuro

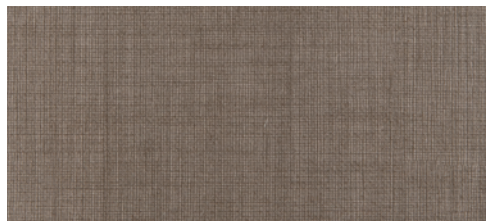

123 Tessuto medio

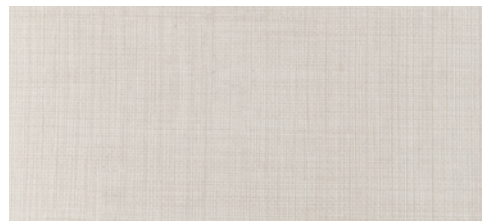

305 Tessuto chiaro



424 Ossido

CAT. 3

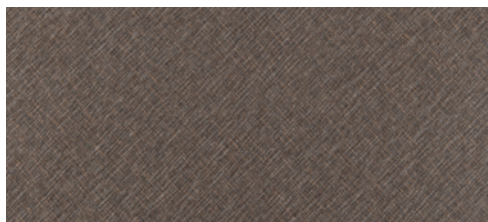

385 Lino bronzo

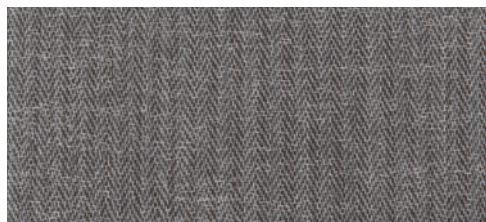

409 Corteccia

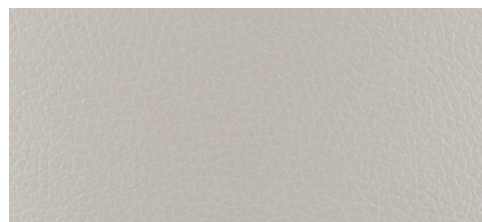

406 Primo fiore grigio

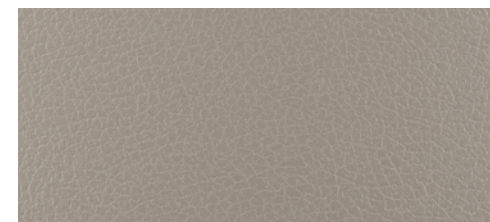

405 Primo fiore tortora



404 Primo fiore beige

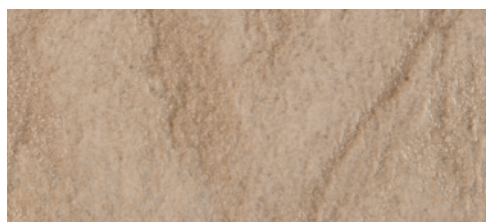

415 Deserto

Vetri



01 Trasparente



03 Satinato

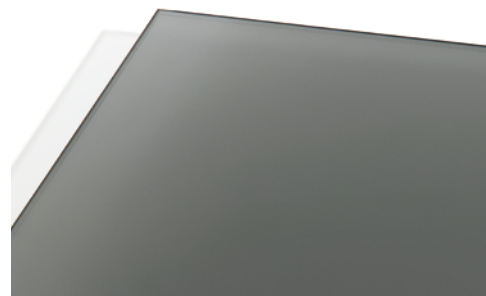

05 Fumé



02 Extrachiaro

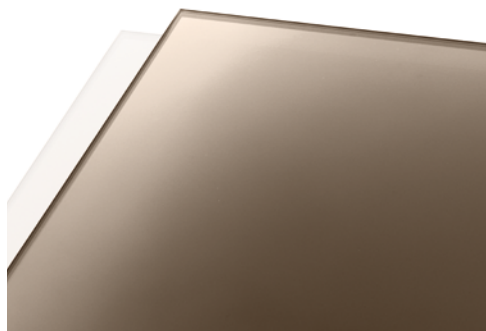

04 Bronzo



06 Verniciato a campione

METRICA[®]
STRUTTURALE

Capitolato tecnico



METRICA® è un sistema di pareti interne mobili attrezzate con struttura portante, con spessore nominale **104 mm**, fornita in **quattro soluzioni** formalmente diverse:

VERSIONI

METRICA®R

Parete composta da moduli dotati di vetro centrale di spessore 33.1 o temperato 5 mm

METRICA®V

Parete composta da moduli dotati di doppio vetro intelaiato di spessore 33.1 o temperato 5 mm

METRICA®S

Parete composta da moduli dotati di doppio vetro a filo esterno con perimetro serigrafato - vetro temperato 5 mm

METRICA®SOLID

Parete composta da pannelli ciechi a base di particelle di legno di spessore 18 mm

DESCRIZIONE GENERALE

La parete, di spessore totale 104 mm, è costituita da una **struttura portante** in profilati verticali di **lamiera zincata UNI EN 10143**, assemblati meccanicamente, con sezione di 65x33 mm sp=8/10 mm, orizzontalmente è controventata da profilati sagomati, sp=10/10 mm, dello stesso materiale. Nei punti di contatto tra montante e pannelli di chiusura è interposta una guarnizione morbida in veolene, avente funzione di tenuta e di fuga marcapannello.

I **montanti** sono dotati di asolatura a cremagliera, con fori rettangolari a passo 32 mm, atta ad accogliere i ganci a baionetta di ancoraggio dei pannelli vetrati o ciechi.

Le operazioni di livellamento verticali sono assicurate da due piedini regolabili manualmente.

Le **guide** a pavimento ed a soffitto sono costituite da profili estrusi in lega di alluminio 6060 UNI 9006/1. I profili di partenza a parete sono realizzati con profilati di lamiera di alluminio. Tali profili, di contatto con le strutture d'ambito, consentono il perfetto livellamento della parete sia in orizzontale che in verticale e la perfetta chiusura contro i paramenti murari esistenti.

I **moduli ciechi** sono realizzati in pannelli a base di particelle di legno (truciolare) nobilitati su entrambe le facce con carta melamminica e rifiniti perimetralmente con bordi in ABS, sp=10/10 mm.



Il sistema è dotato di **profili d'angolo**, fissi e variabili, che permettono connessioni a 2/3/4 vie.

Le **connessioni lineari** tra pannelli avvengono mediante i montanti.

La parete, sia nella tipologia cieca che vetrata, consente di modificare le caratteristiche acustiche degli spazi in cui viene inserita. Migliori prestazioni si ottengono con la parete cieca dotata di materassino interno in fibra minerale e con la versione a pannelli speciali del tipo acustico.

Le **porte**, disponibili nella tipologia a battente o scorrevole esterna e interna, possono essere fornite sia ad altezza standard sia ad altezza di parete. Entrambe le tipologie sono previste ad anta singola e doppia.

La **versione intelaiata** permette l'alloggiamento di chiudiporta superiori ad incasso e ghigliottine acustiche inferiori; quella vetrata permette unicamente l'installazione del chiudiporta esterno.

Il **tipo scorrevole** con guida esterna è realizzabile in legno, in vetro intelaiato singolo o solo vetro filo lucido; con guida incassata all'interno della struttura della parete, è realizzabile solo in legno o vetro filo lucido. Il corretto scorrimento è garantito da carrelli con ammortizzatore di chiusura ed apertura delle ante.

L'**anta in legno tamburato**, spessore 43 mm, è realizzata con struttura interna a nido d'ape inserita in un telaio perimetrale in legno di abete e pannelli fibrolegnosi sui due lati e rifinita con laminato HPL bordato in ABS, sp=10/10 mm.

L'**anta in vetro intelaiata**, perimetralmente presenta profili estrusi in lega di alluminio 6060 UNI 9006/1, di larghezza differenziata, e lastra interna in vetro temperato o stratificato (3+3 mm), con finitura trasparente o acidata.

Nelle ante in legno o con vetro intelaiato, le cerniere previste sono: esterne a bilico, con apertura a 180°; a scomparsa nel telaio, regolabili su tre assi, con apertura a 180°.

L'**anta in vetro** è costituita da una lastra temperata, con finitura trasparente o acidata, di spessore 10 mm.

Le cerniere previste nelle ante filo lucido sono: pressofuse in alluminio con apertura a 110° o 180°; a bilico, in alluminio e acciaio, con apertura a 180°; lineari, in alluminio e acciaio, con apertura a 180°.

Gli **stipiti** delle porte ed i montanti, realizzati in profili estrusi di alluminio a "cannocchiale" e dotati di guarnizioni di battuta in PVC, in colore grigio RAL 9006, permettono l'alloggiamento di eventuali cavi elettrici e l'inserimento di punti di comando a frutto singolo.



In corrispondenza del punto di battuta della serratura, sono previste controbordi in acciaio incassati nel telaio di alluminio, che garantiscono precisione di chiusura dello scrocco ed estrema robustezza.

Per consentire un adeguato **cablaggio** della parete, è previsto un **modulo apribile cieco**, studiato per favorire l'installazione di punti luce, punti presa, termostati, sensori di allarmi ed altre apparecchiature dimensionalmente compatibili.

Le porte sono dotate di una ricca **gamma di maniglie** di serie che può essere ulteriormente incrementata grazie all'impiego di serrature con piastra universale adatte anche all'installazione di articoli fuori catalogo.

Il sistema METRICA® viene proposto anche in versione a schermo del tipo "open space", completo di piedi di stabilizzazione, e come rivestimento a parete.

La parete è perfettamente **integrabile** con la versione a contenitore Quadra.



01. Modulo intero in legno - Prova Meccanica -
Certificato n. 253560 IT/EN - UNI 8201:1981

02. Pannelli in truciolare nobilitato in rovere moro - Reazione al Fuoco -
Certificato n. 253501 IT/EN - UNI EN 13823:2005

03. Classificazione Reazione al Fuoco -
Certificato n. 253504 IT/EN - UNI EN 13501 1:2007



01. Modulo intero in legno con isolante interno solo nelle fasce di compensazione - lana di vetro d=35 Kg/mc Sp.=60 mm
- Prova Acustica -

Certificato n. 248482 IT/EN - UNI EN ISO 140-3:2006 ed UNI EN ISO 717-1:2007

02. Modulo intero in legno con isolante interno in lana di vetro d=35 Kg/mc Sp.=60 mm ed echostop -
Prova Acustica -

Certificato n. 248483 IT/EN - UNI EN ISO 140-3:2006 ed UNI EN ISO 717-1:2007

03. Modulo a fasce in legno con isolante interno solo nelle fasce di compensazione - lana di vetro d=35 Kg/mc Sp.=60 mm
- Prova Acustica -

Certificato n. 248488 IT/EN - UNI EN ISO 140-3:2006 ed UNI EN ISO 717-1:2007

04. Modulo a fasce in legno con isolante interno in lana di vetro d=35 Kg/mc Sp.=60 mm e profilo coestruso - Prova
Acustica -

Certificato n. 248489 IT/EN - UNI EN ISO 140-3:2006 ed UNI EN ISO 717-1:2007

05. Modulo intero ed echostop - Prova Acustica -

Certificato n. 248484 IT/EN - UNI EN ISO 140-3:2006 ed UNI EN ISO 717-1:2007



METRICA R prove acustiche e meccaniche

01. Modulo intero con lastra centrale in vetro stratificato 6/7- isolante interno alle fasce di compensazione ed echostop - Prova Acustica -

Certificato n. 248485 IT/EN - UNI EN ISO 140-3:2006 ed UNI EN ISO 717-1:2007

02. Modulo a fasce con lastra centrale in vetro stratificato 6/7 - isolante interno alle fasce di compensazione ed echo stop - Prova Acustica -

Certificato n. 248490 IT/EN - UNI EN ISO 140-3:2006 ed UNI EN ISO 717-1:2007

03. Modulo a fasce con lastra centrale in vetro stratificato 6/7 - isolante interno alle fasce di compensazione e profilo coestruso - Prova Acustica -

Certificato n. 254591 IT/EN - UNI EN ISO 140-3:2006 ed UNI EN ISO 717-1:2007

04. Modulo con mezzo vetro - lastra centrale in vetro stratificato 6/7- isolante interno alle fasce di compensazione ed echostop - Prova Acustica -

Certificato n. 248046 IT/EN - UNI EN ISO 140-3:2006 ed UNI EN ISO 717-1:2007

05. Modulo con mezzo vetro - lastra centrale in vetro stratificato 6/7- isolante interno, profilo coestruso ed echostop - Prova Acustica -

Certificato n. 248047 IT/EN - UNI EN ISO 140-3:2006 ed UNI EN ISO 717-1:2007

06. Modulo intero in vetro - lastra centrale in stratificato 6/7 - Prova Meccanica -

Certificato n. 253562 IT/EN - UNI 8201:1981



01. Modulo intero con due lastre incollate in vetro temperato 5 mm- isolante interno alle fasce di compensazione ed echostop - Prova Acustica -

Certificato n. 248494 IT/EN - UNI EN ISO 140-3:2006 ed UNI EN ISO 717-1:2007

02. Modulo a fasce con due lastre incollate in vetro temperato 5 mm- isolante interno alle fasce di compensazione + profilo coestruso ed echostop anche nei montanti - Prova Acustica -

Certificato n. 254593 IT/EN - UNI EN ISO 140-3:2006 ed UNI EN ISO 717-1:2007

03. Modulo con mezzo vetro - due lastre incollate in vetro temperato 5 mm- isolante interno alle fasce di compensazione ed echostop - Prova Acustica -

Certificato n. 248045 IT/EN - UNI EN ISO 140-3:2006 ed UNI EN ISO 717-1:2007

04. Modulo con mezzo vetro - due lastre incollate in vetro temperato 5 mm - isolante interno, profilo coestruso ed echostop - Prova Acustica -

Certificato n. 248048 IT/EN - UNI EN ISO 140-3:2006 ed UNI EN ISO 717-1:2007

05. Modulo intero in vetro - due lastre incollate in vetro temperato 5 mm - Prova Meccanica -

Certificato n. 253563 IT/EN - UNI 8201:1981



01. Modulo intero con due lastre intelaiate in vetro stratificato 6/7 - isolante interno alle fasce di compensazione ed echostop - Prova Acustica -

Certificato n. 248486 IT/EN - UNI EN ISO 140-3:2006 ed UNI EN ISO 717-1:2007

02. Modulo a fasce con due lastre intelaiate in vetro stratificato 6/7- isolante interno alle fasce di compensazione ed echostop - Prova Acustica -

Certificato n. 248492 IT/EN - UNI EN ISO 140-3:2006 ed UNI EN ISO 717-1:2007

03. Modulo intero con due lastre intelaiate in vetro stratificato 6/7- isolante interno alle fasce di compensazione e profilo coestruso - Prova Acustica -

Certificato n. 248487 IT/EN - UNI EN ISO 140-3:2006 ed UNI EN ISO 717-1:2007

04. Modulo a fasce con due lastre intelaiate in vetro stratificato 6/7- isolante interno alle fasce di compensazione e profilo coestruso - Prova Acustica -

Certificato n. 248493 IT/EN - UNI EN ISO 140-3:2006 ed UNI EN ISO 717-1:2007



05. Modulo con mezzo vetro - due lastre intelaiate in vetro stratificato 6/7 - isolante interno alle fasce di compensazione ed echostop - Prova Acustica -

Certificato n. 248044 IT/EN - UNI EN ISO 140-3:2006 ed UNI EN ISO 717-1:2007

06. Modulo con mezzo vetro - due lastre intelaiate in vetro stratificato 6/7- isolante interno, profilo coestruso ed echostop - Prova Acustica -

Certificato n. 248049 IT/EN - UNI EN ISO 140-3:2006 ed UNI EN ISO 717-1:2007

07. Modulo intero in vetro - due lastre intelaiate in vetro stratificato 6/7 - Prova Meccanica -

Certificato n. 253561 IT/EN - UNI 8201:1981



METRICA PORTE

01. Porta in legno - Prova Acustica -
Certificato n. 251626 IT/EN - UNI EN ISO 140-3:2006 ed UNI EN ISO 717-1:2007

02. Porta in vetro temperato 10 mm - Prova Acustica -
Certificato n. 251625 IT/EN - UNI EN ISO 140-3:2006 ed UNI EN ISO 717-1:2007

03. Porta in vetro stratificato 6/7 intelaiato - Prova Acustica -
Certificato n. 251624 IT/EN - UNI EN ISO 140-3:2006 ed UNI EN ISO 717-1:2007

METRICA D: PORTA CIECA

01. Porta cieca 104 mm. - Prova Acustica -
Certificato n. 279745 IT/EN - UNI EN ISO 140-3:2006 ed UNI EN ISO 717- 1:2007

METRICA D: PORTA VETRATA

01. Porta vetrata 104 mm. - Prova Acustica -
Certificato n. 279746 IT/EN - UNI EN ISO 140-3:2006 ed UNI EN ISO 717-1:2007



Etoile s.r.l. - Società Unipersonale

Via D. Albertario, 50 61032 Zona Ind.le Bellocchi - Fano (PU) Italy
P. +39.0721.85.59.34 - F. +39.0721.85.92.14
info@etoilesrl.it - www.etoilesrl.it