

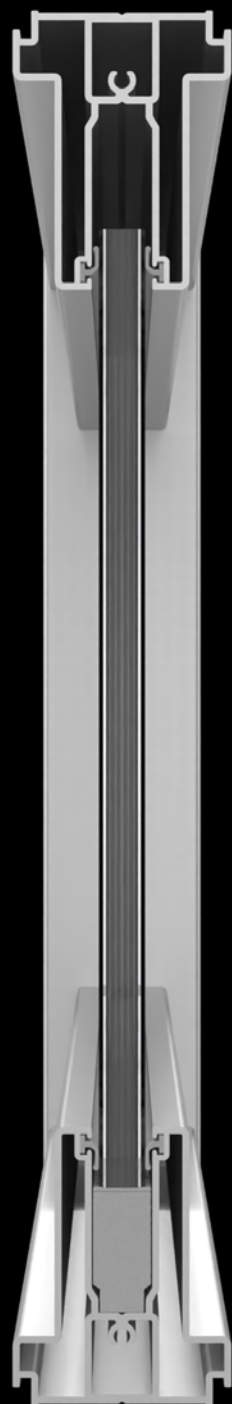

☐ ETOILE

**UNICA® R**

---





- 01.** Spessore 51 mm
- 02.** Profilo fermavetro - dimensioni 47 x 60 mm
- 03.** Profili a pavimento, a soffitto, angoli e partenze in estruso di alluminio 6060 UNI 9006/1
- 04.** Vetro singolo centrale - spessore 55.1/55.2 o temperato 10 mm
- 05.** Pannello cieco in vari formati autoportante o ancorato al vetro
- 06.** Profili d'angolo fissi e variabili - connessioni 2/3/4 vie
- 07.** Giunzioni verticali tra elementi vetrati in alluminio, policarbonato e biadesivo trasparente
- 08.** Telaio porta cablabile
- 09.** Modulo tecnico ispezionabile
- 10.** 7 versioni di porte battenti - cieche, in vetro temperato e intelaiate
- 11.** 5 versioni di porte scorrevoli esterne - cieche, in vetro temperato e intelaiate

**01.** Vetro 55.1 - **32 dB**

**02.** Vetro 55 + 0,5 PVB acustico + isolante - **35 dB**





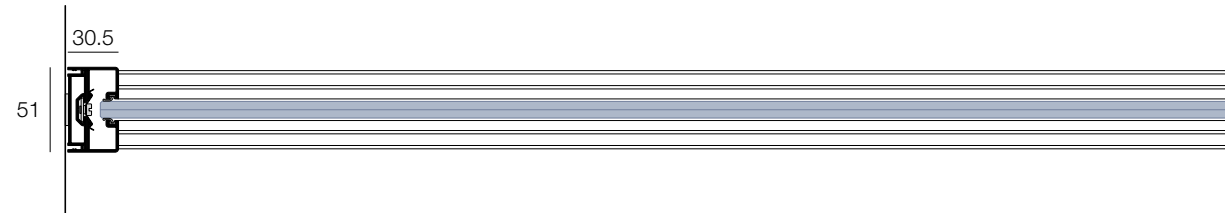
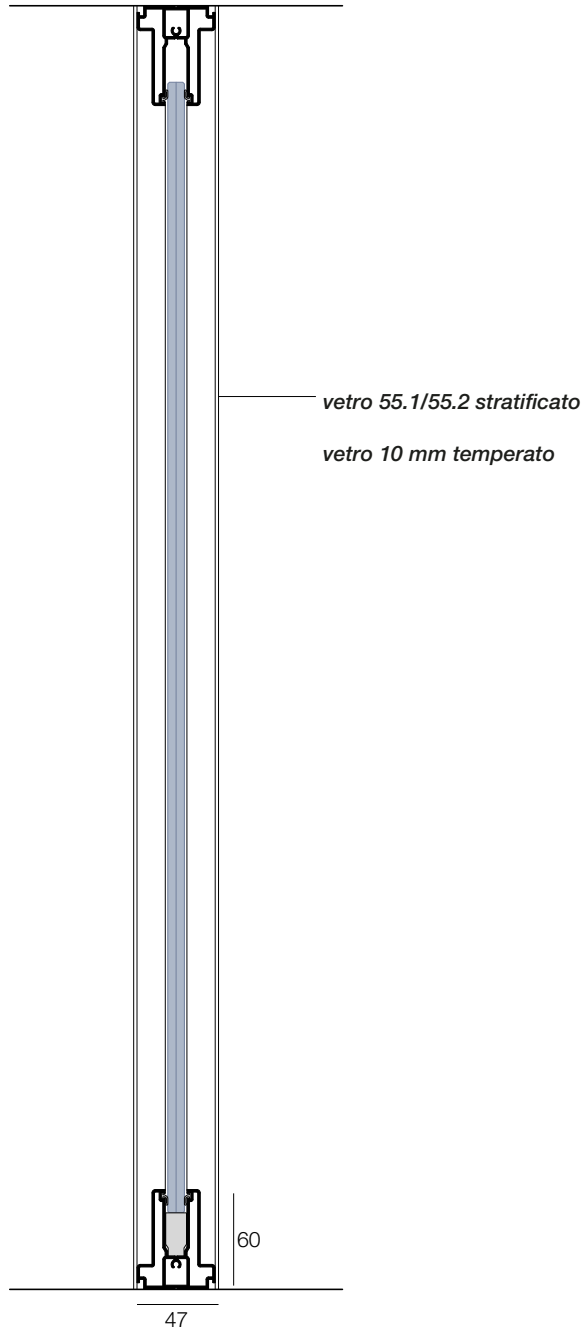

**Partenza fissa da parete**

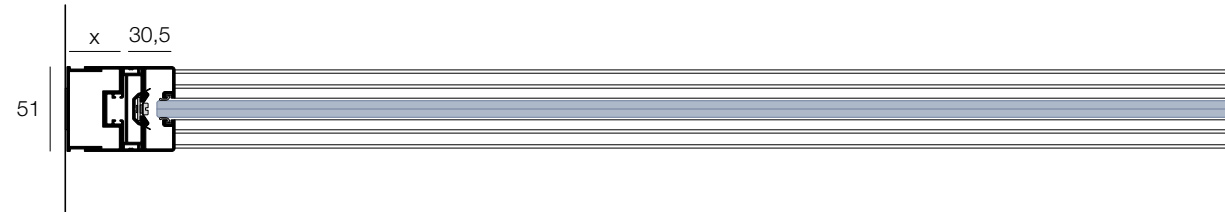

**Partenza telescopica da parete**



**Profilo terminale**

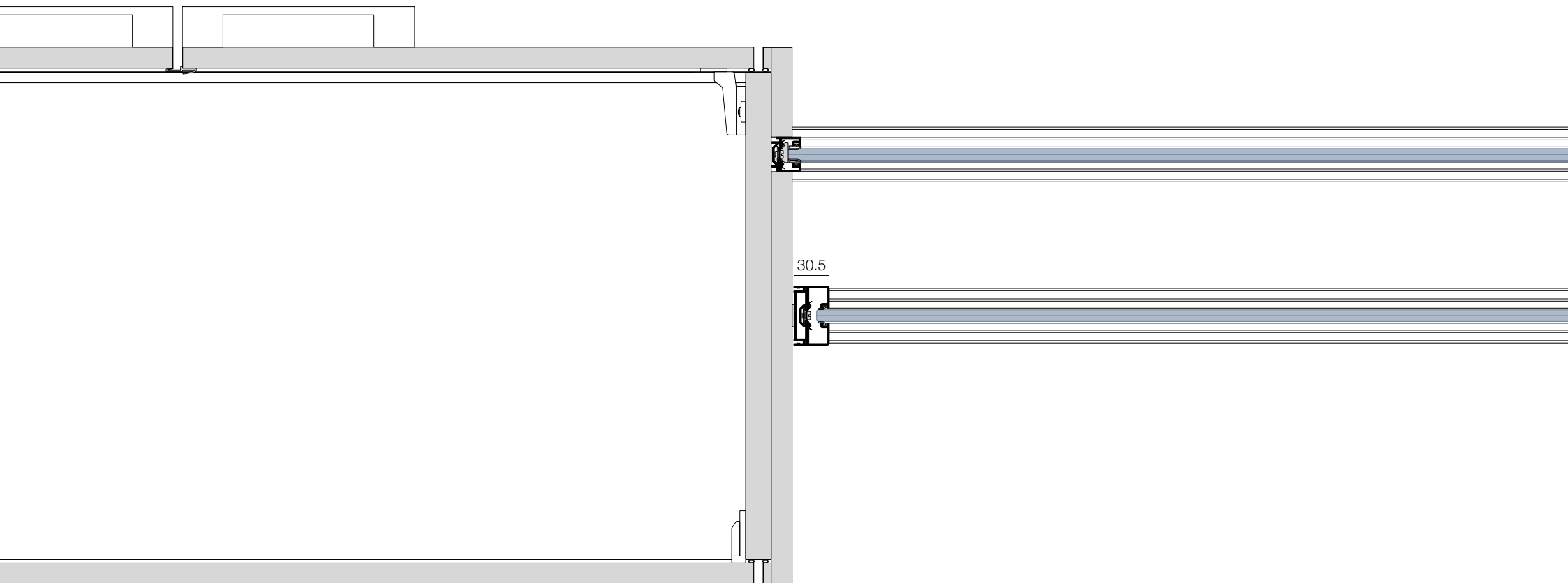

**Partenze da contenitore**



variabile



**Connessione  
in alluminio**



**Connessione  
in policarbonato**



**Connessione  
con biadesivo tecnico**



**Connessione  
a tre vie  
in alluminio**



**Connessione  
a tre vie  
in policarbonato**



**Connessione  
a tre vie  
con biadesivo tecnico**

# Angoli



Angolo a 90°  
in policarbonato/alluminio

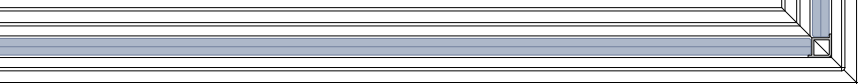

Angolo a 90°  
con biadesivo tecnico



Angolo 2 vie

Angolo variabile

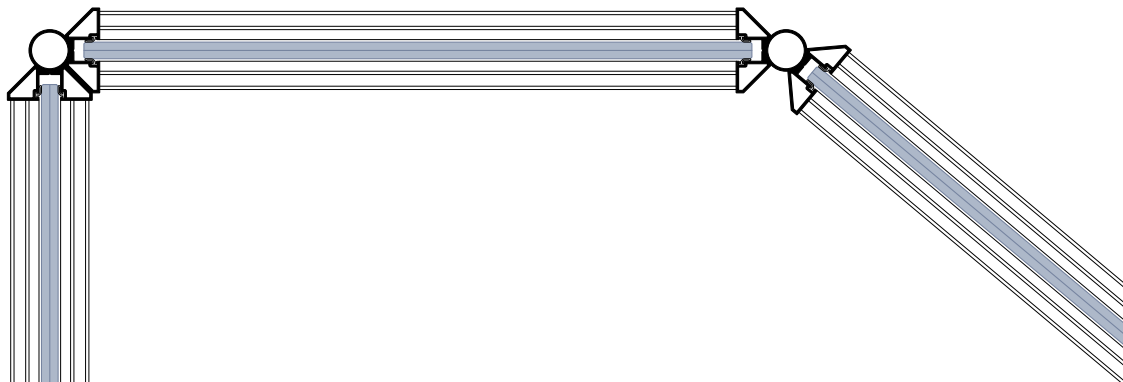

Angolo 3 vie

Angolo 4 vie

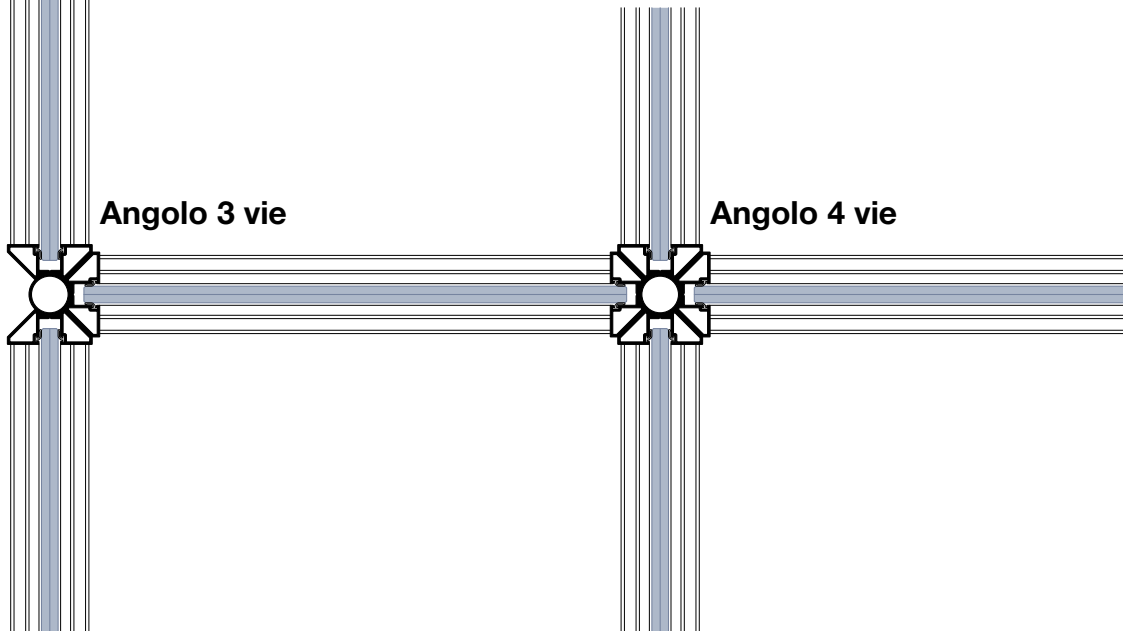

# Cablaggio e modulo tecnico della porta a battente



## Modulo tecnico

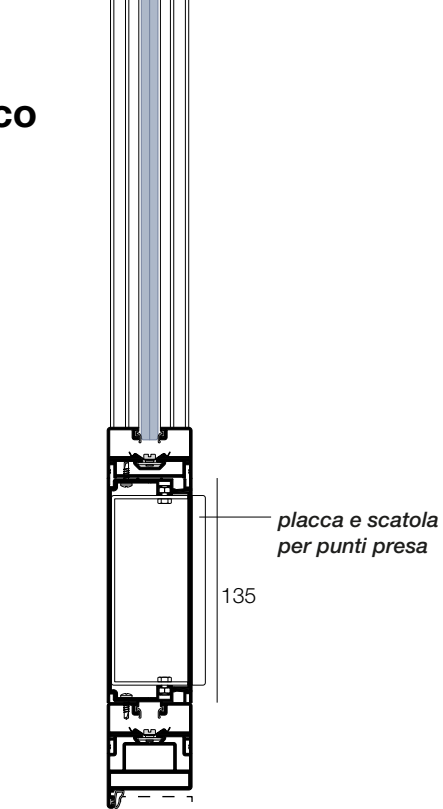

## Soluzione di cablaggio

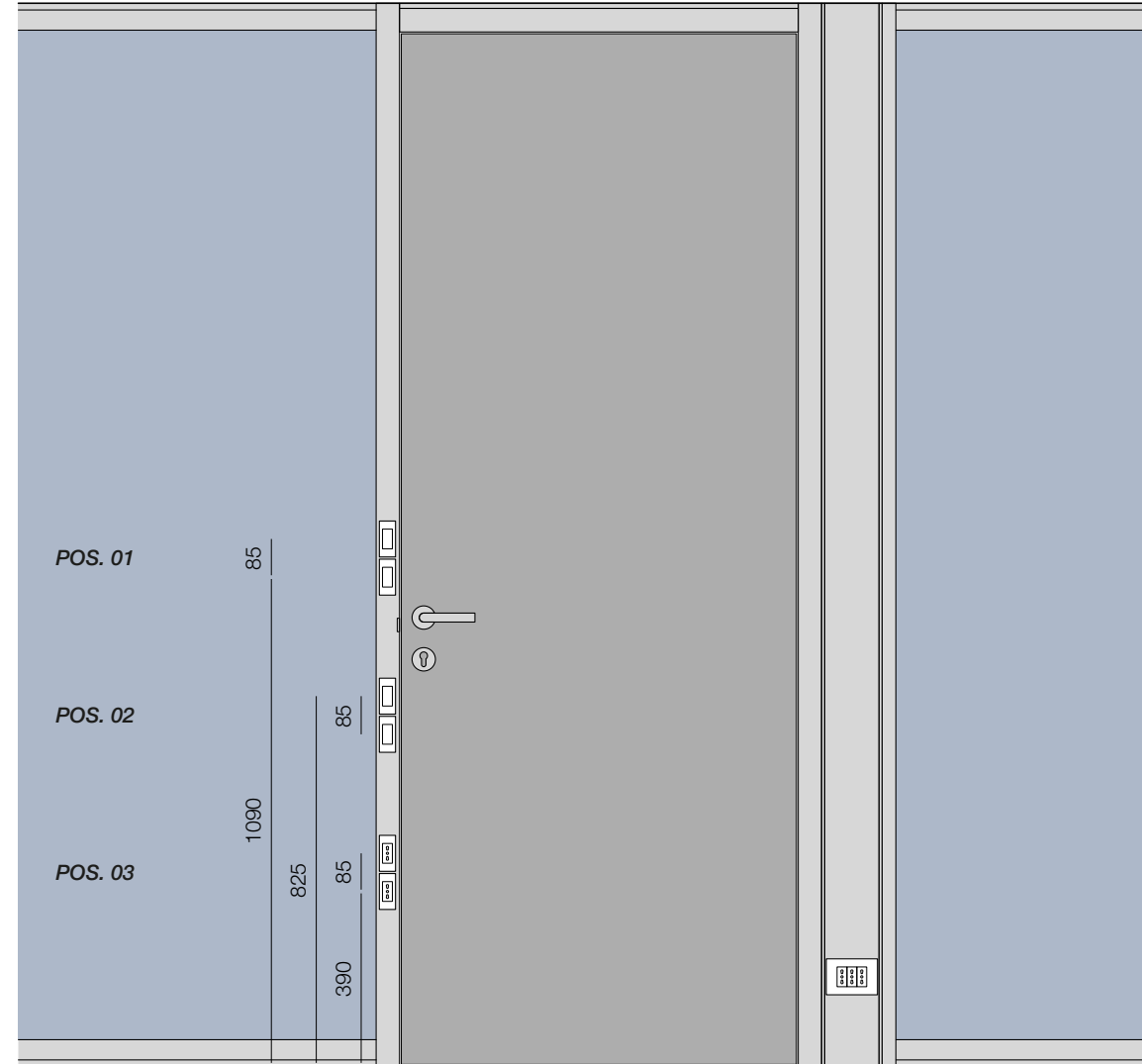
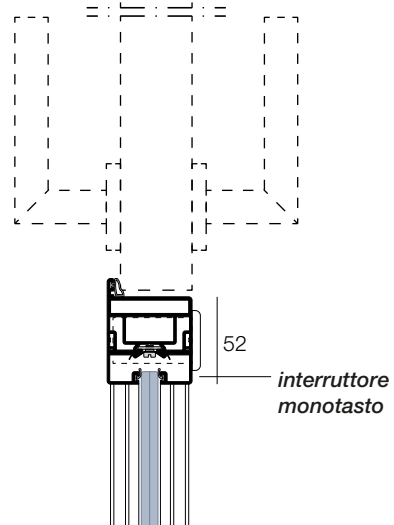

\*posizioni possibili di interruttori e prese su telaio porta

# Cablaggio e modulo tecnico della porta scorrevole



## Modulo tecnico

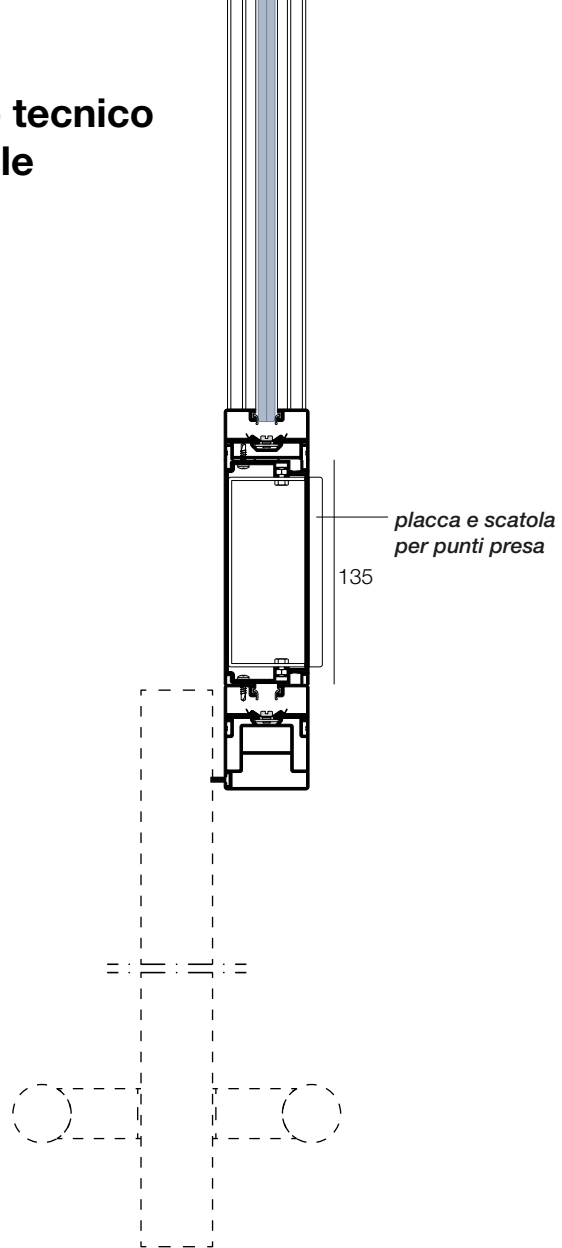

## Soluzione di cablaggio

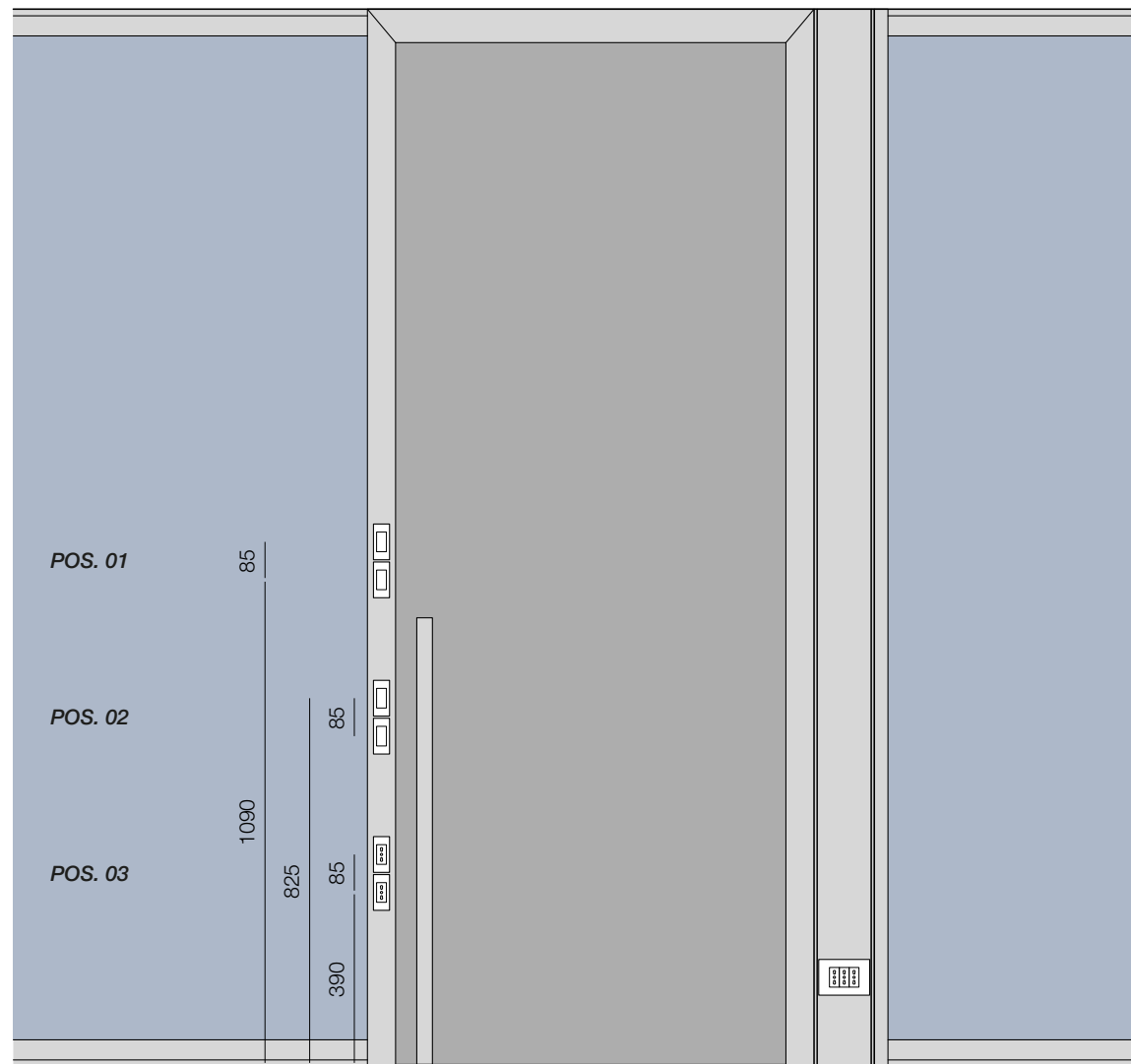
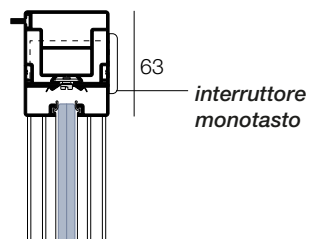

\*posizioni possibili di interruttori e prese su telaio porta

# Pannello cieco



### Parete con pannello sospeso

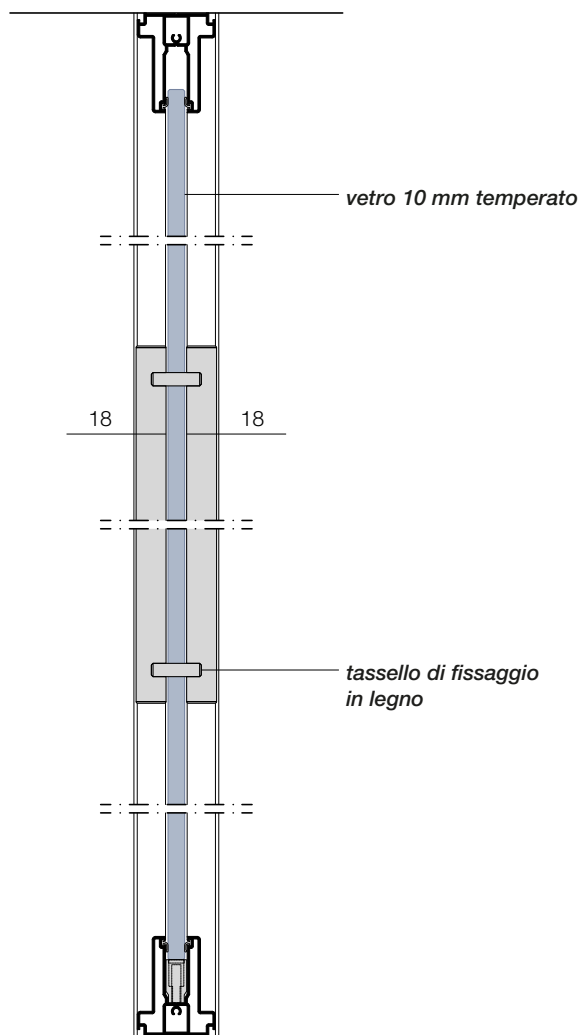

### Parete con pannello intero

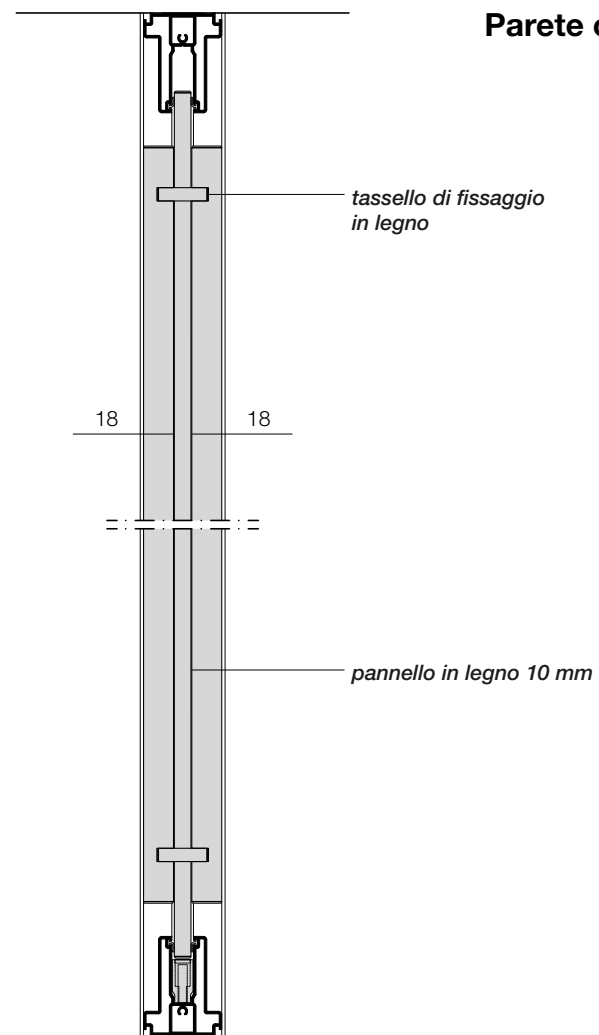



**UNICA®**

Porte e maniglie

---

# TELAI PORTE BATTENTI



Telaio porta su **Unica Slim**

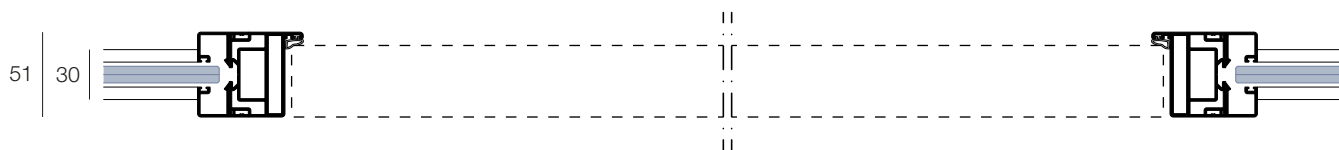

Telaio porta su **Unica U**

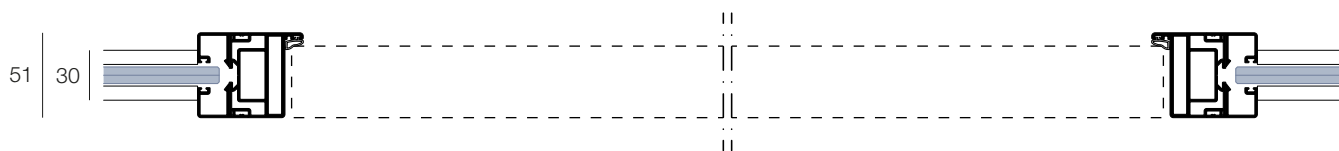

Telaio porta su **Unica SC**

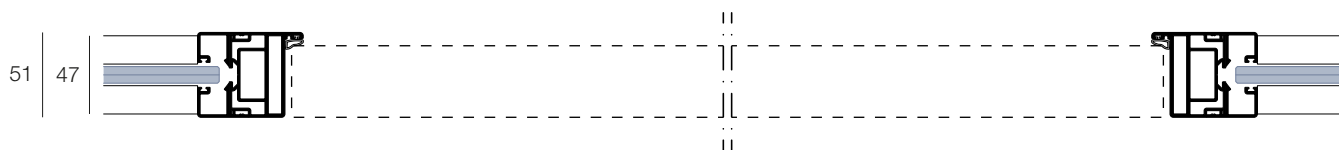

Telaio porta su **Unica R**

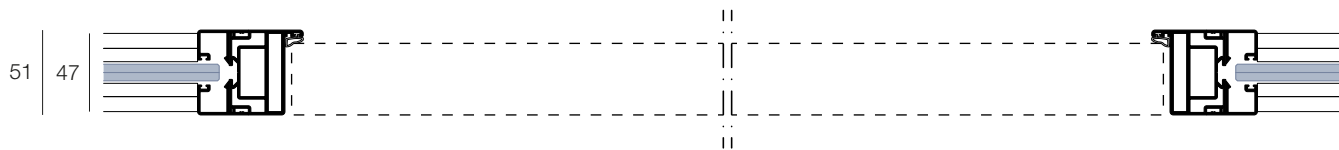

Telaio porta su **Unica D**

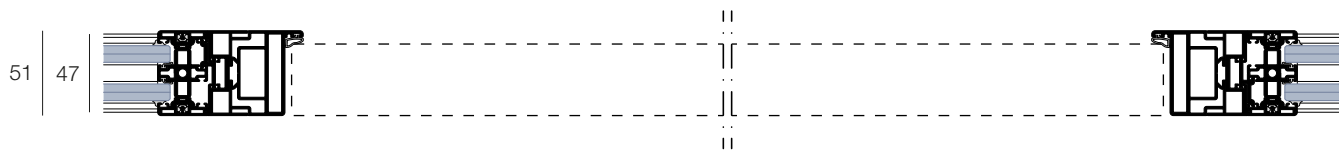

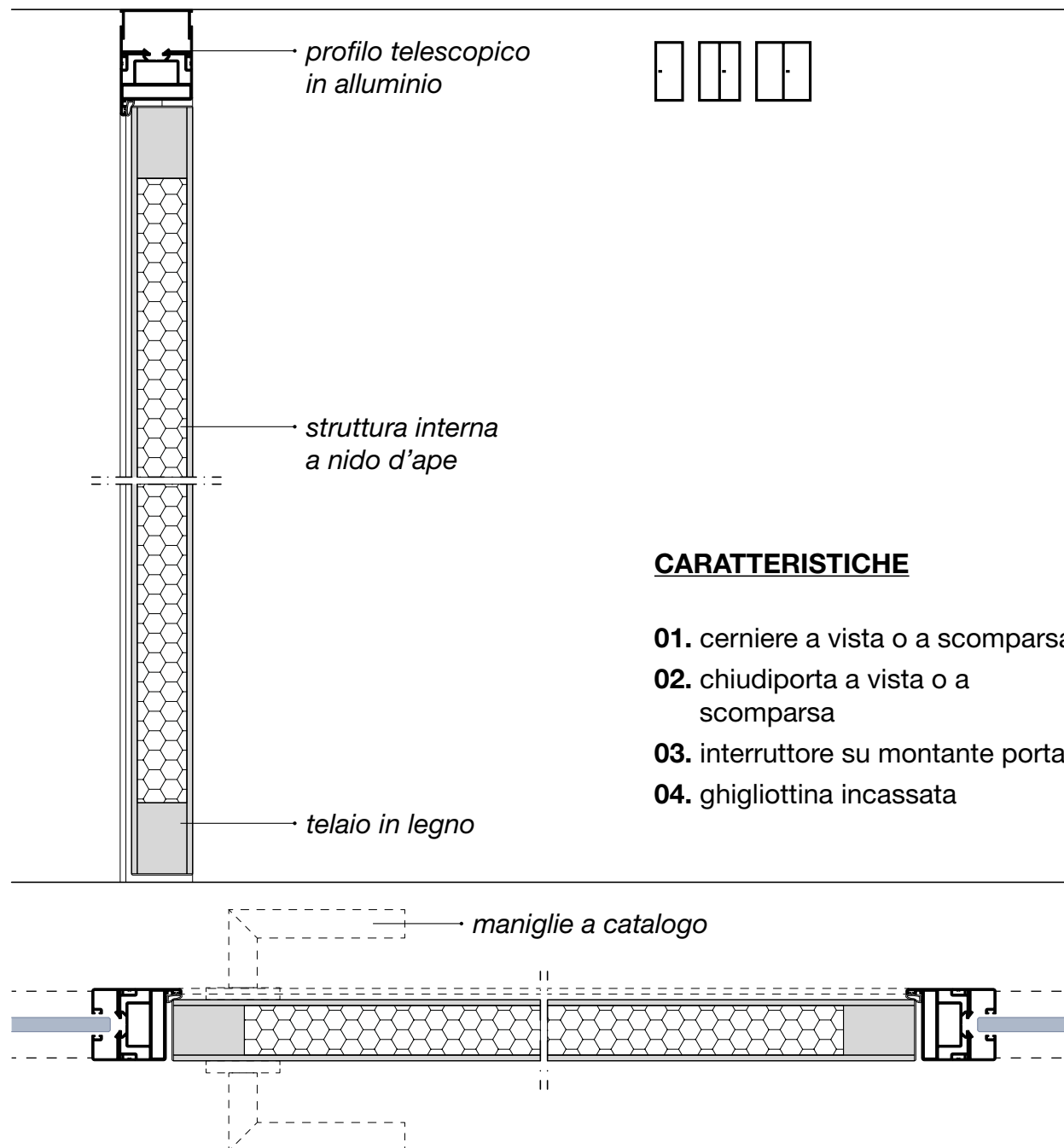

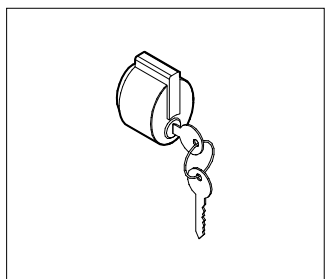

**ML1**

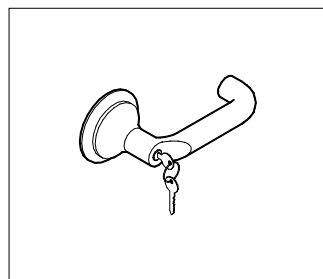

**ML4**

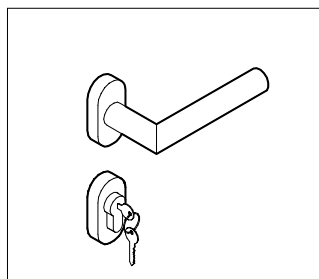

**ML5**

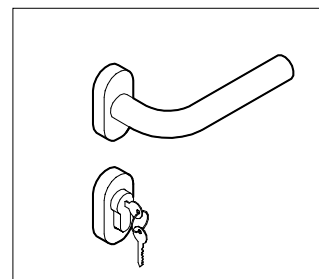

**ML6**

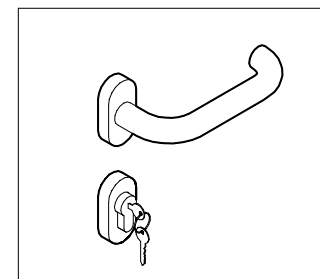

**ML7**

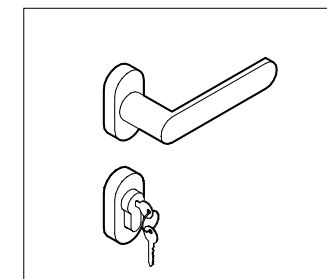

**ML8**

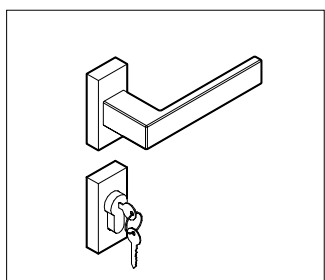

**ML9**

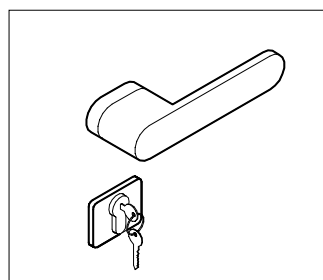

**ML10**

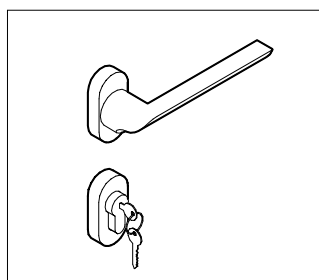

**ML11**

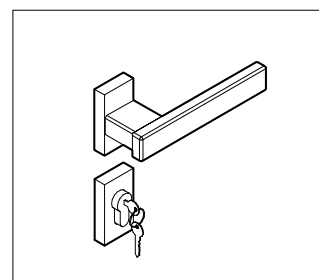

**MLQ**

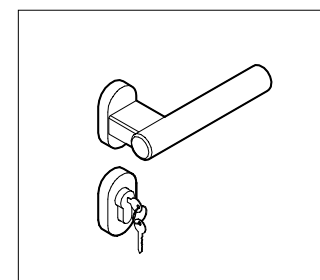

**MLT**

# ANTA VETRO TEMPERATO\_CERNIERE A VISTA sp. 10 mm

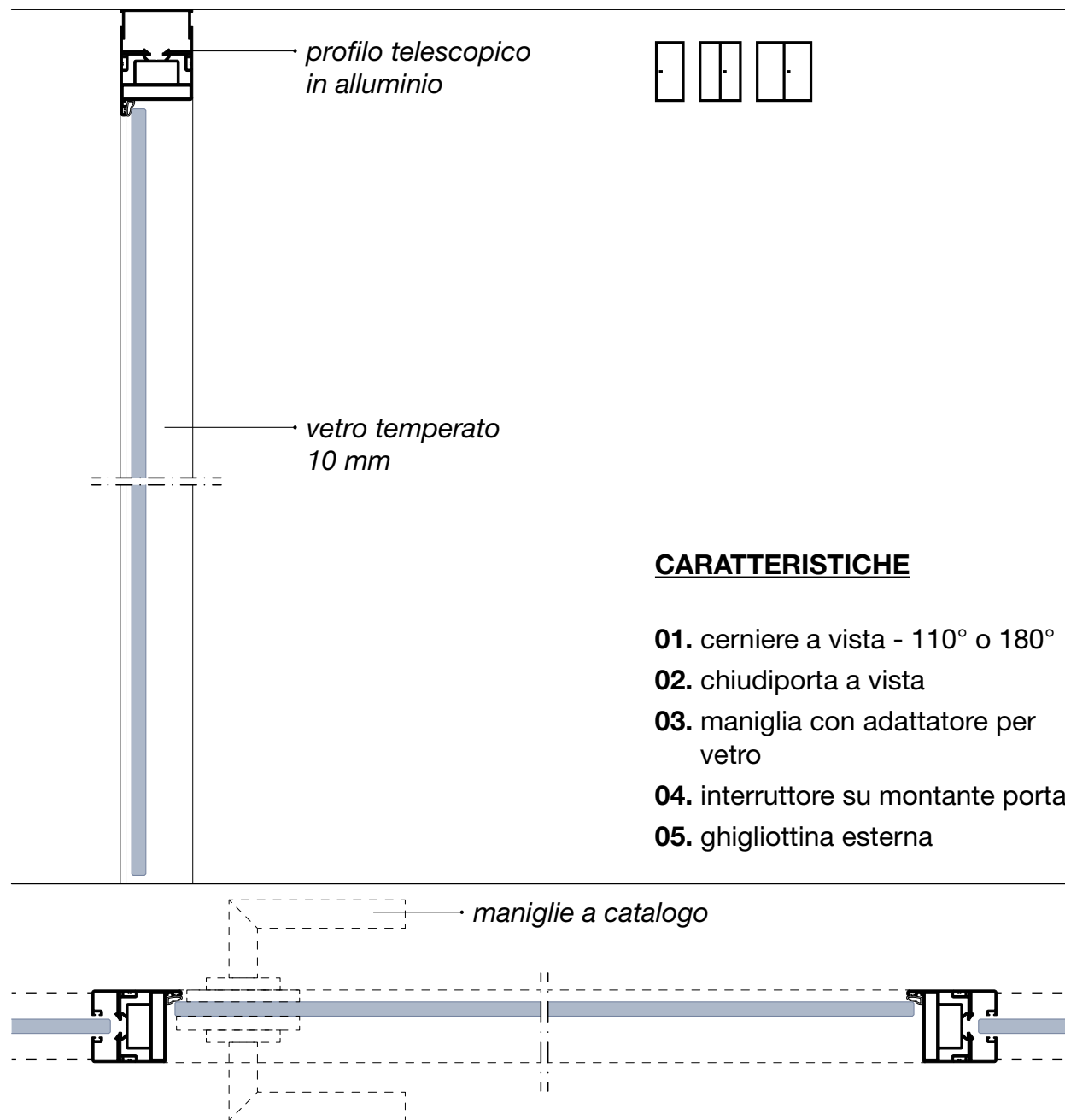

# ANTA VETRO TEMPERATO\_CERNIERE A VISTA sp. 10 mm

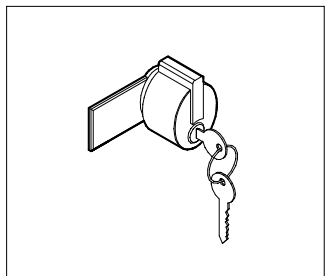

MC1

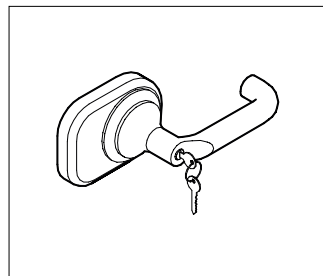

MC4

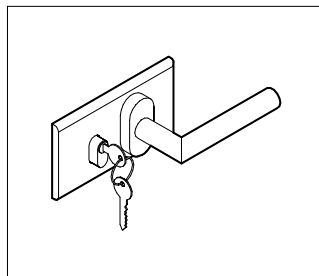

MC5

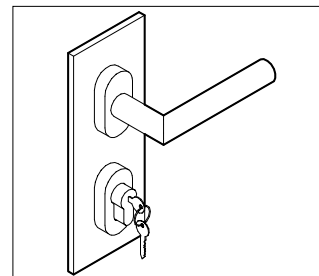

MC5V

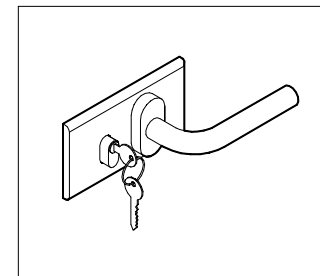

MC6

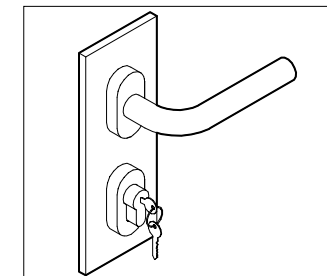

MC6V

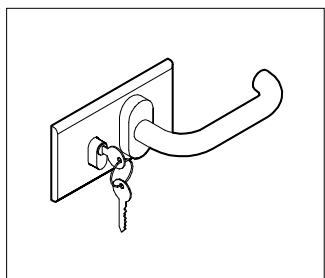

MC7

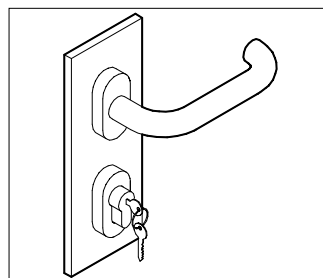

MC7V

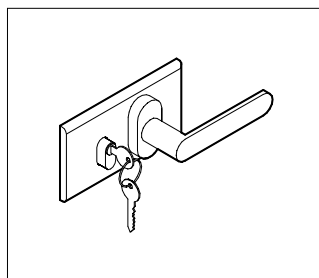

MC8

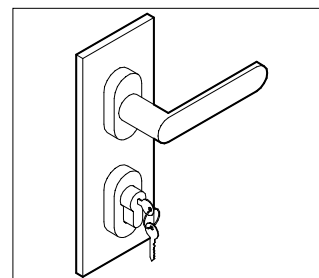

MC8V

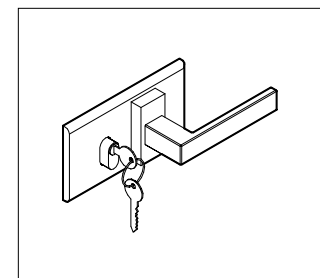

MC9

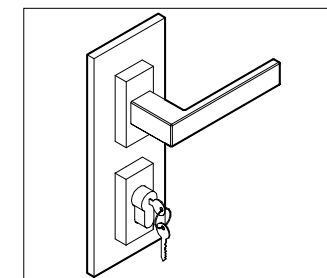

MC9V

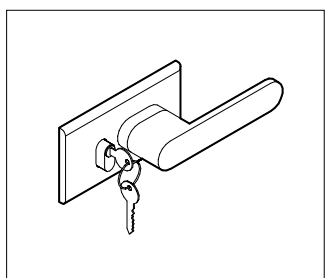

MC10

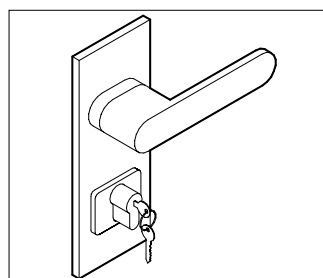

MC10V

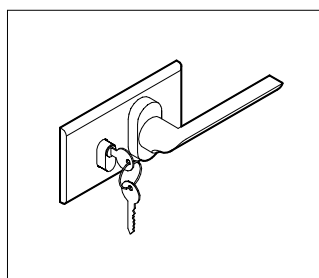

MC11

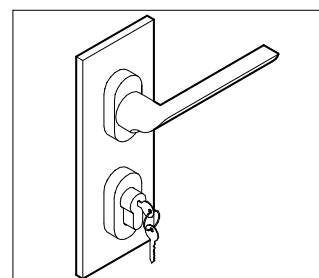

MC11V

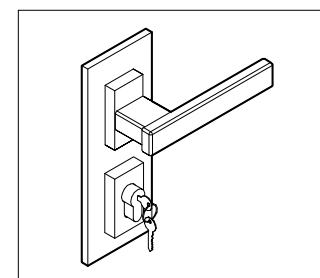

MCQ

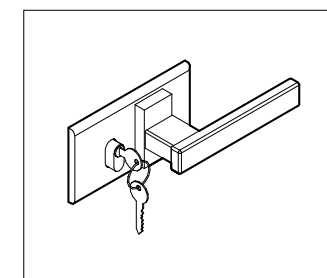

MCQO

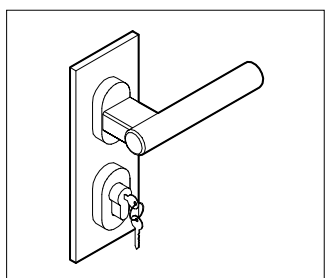

MCT

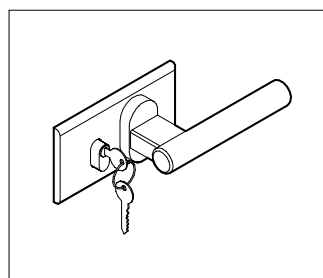

MCTO

# ANTA VETRO TEMPERATO\_CERNIERA CONTINUA sp. 10 mm

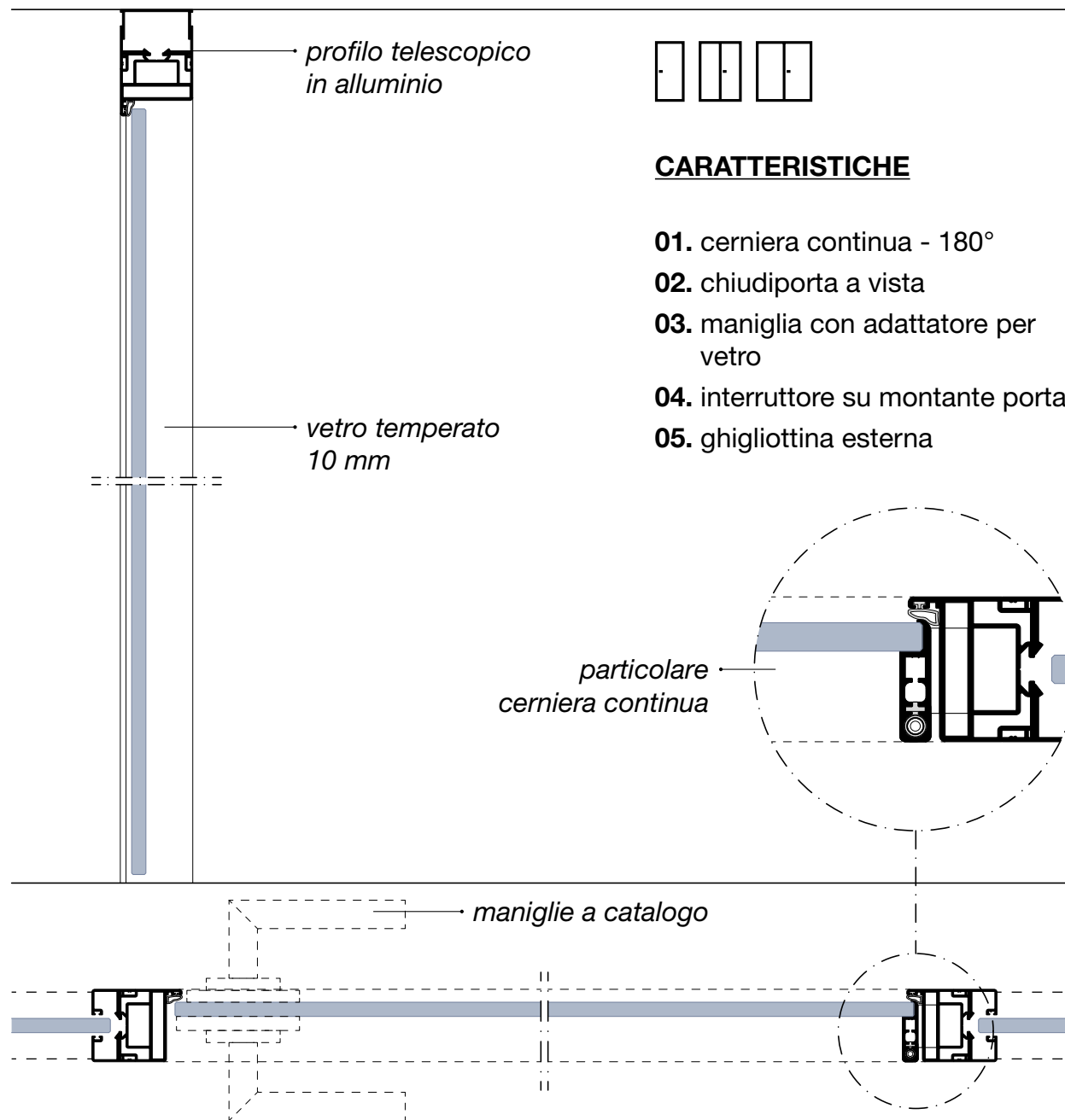

# ANTA VETRO TEMPERATO\_CERNIERA CONTINUA sp. 10 mm

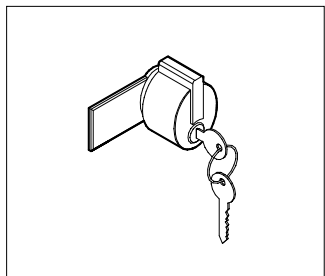

MC1

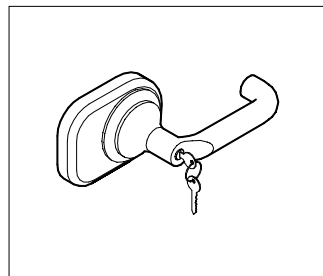

MC4

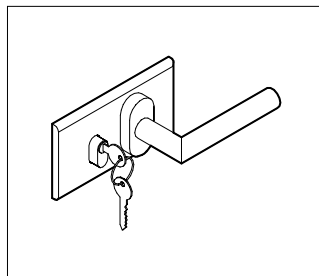

MC5

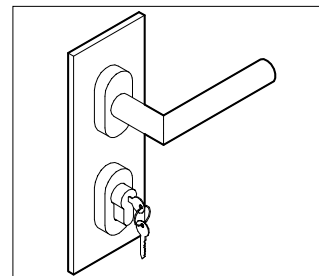

MC5V

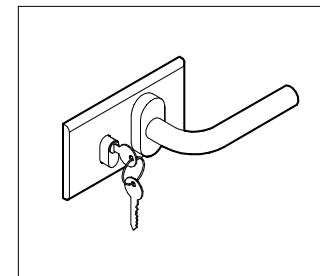

MC6

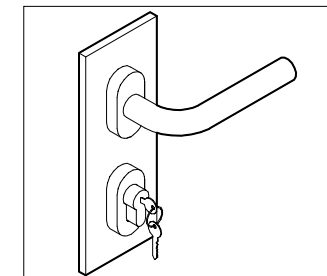

MC6V

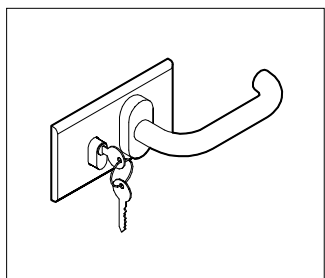

MC7

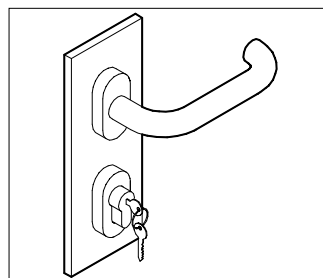

MC7V

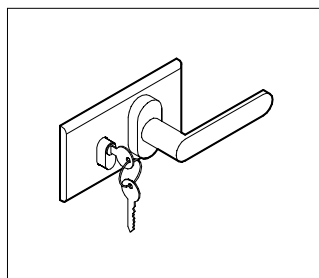

MC8

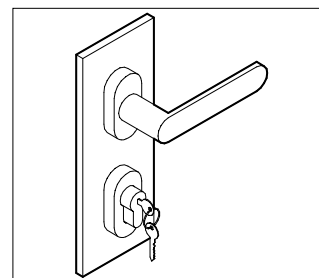

MC8V

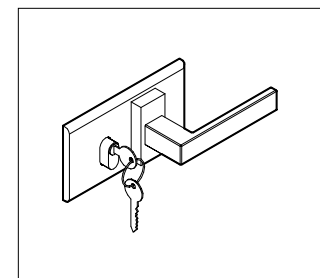

MC9

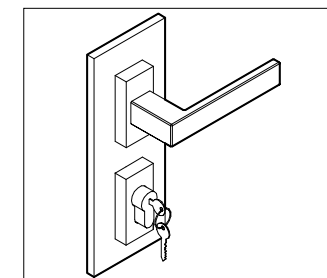

MC9V

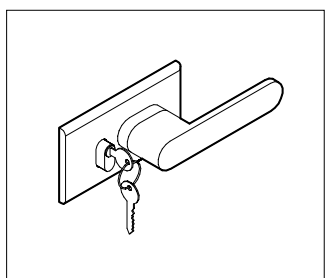

MC10

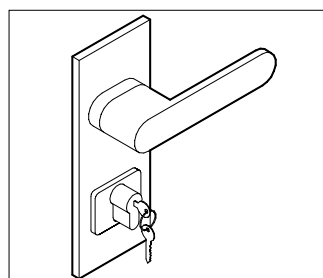

MC10V

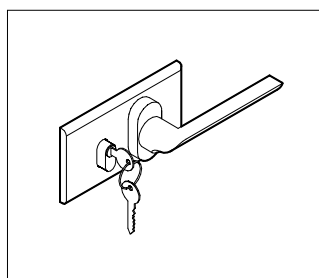

MC11

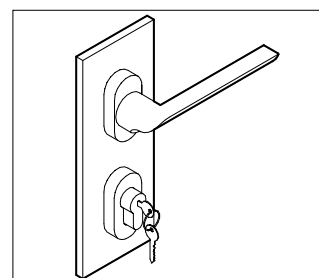

MC11V

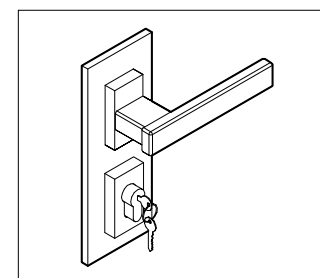

MCQ

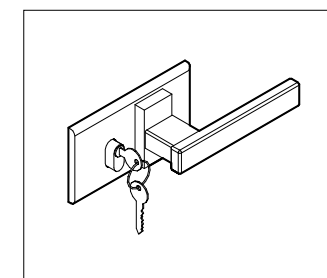

MCQO

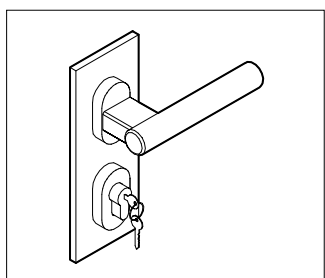

MCT

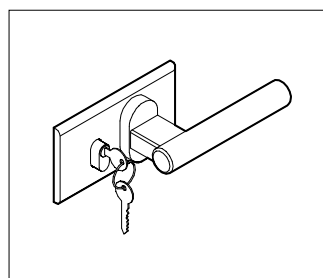

MCTO



# ANTA INTELAIATA GRANDE CON PANNELLO sp. 43 mm

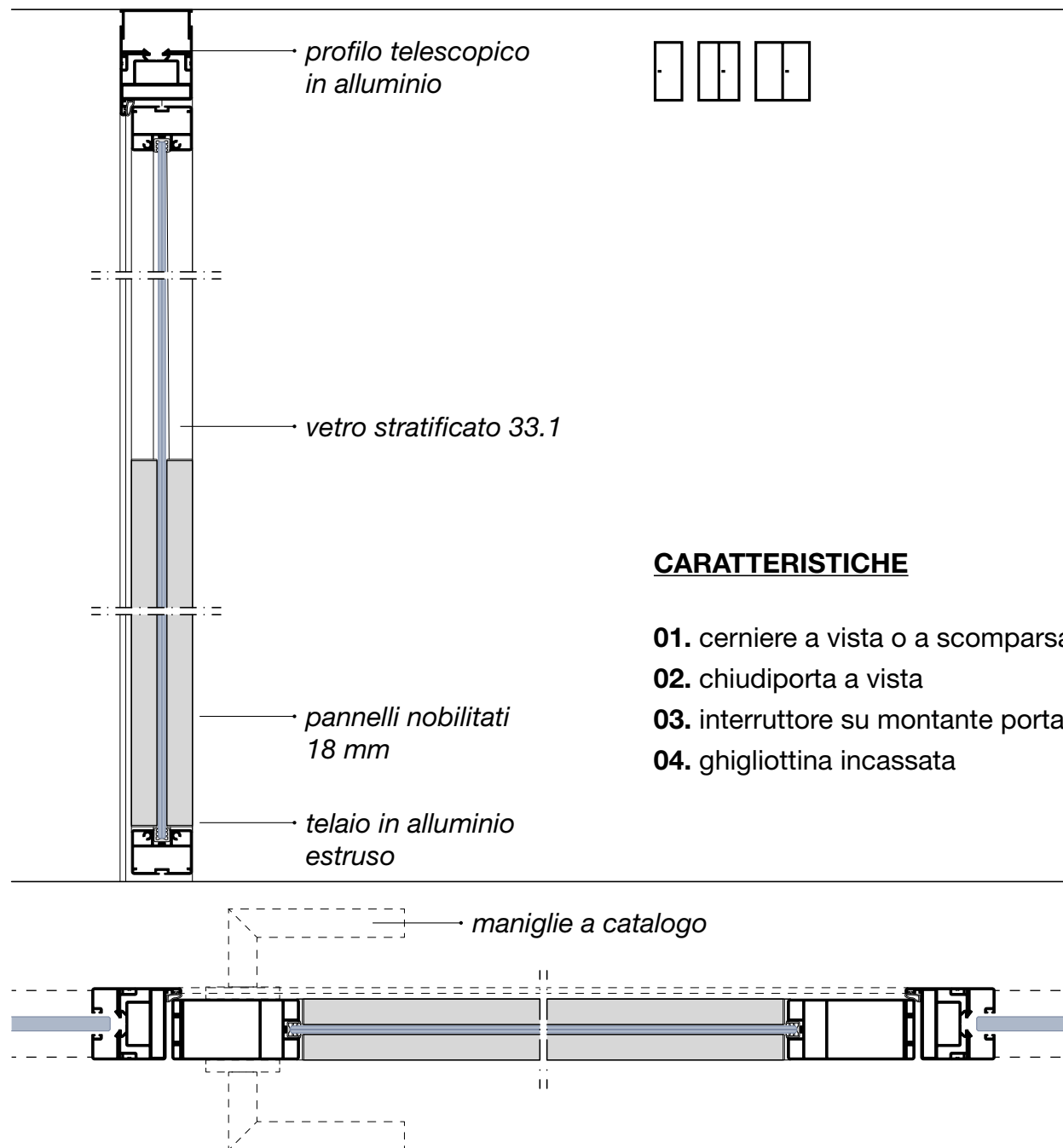

# ANTA INTELAIATA GRANDE CON PANNELLO sp. 43 mm

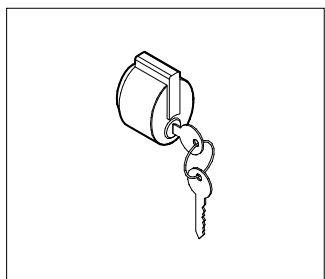

ML1

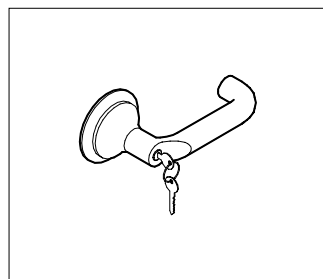

ML4

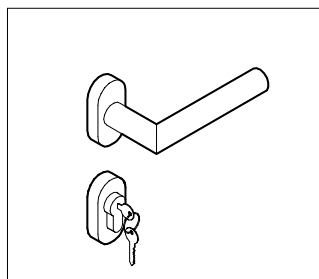

ML5

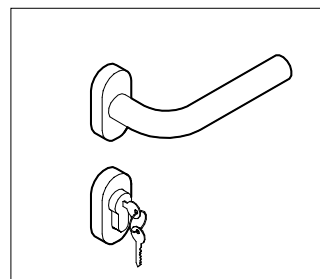

ML6

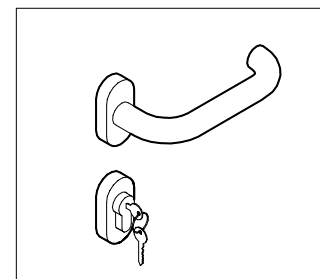

ML7

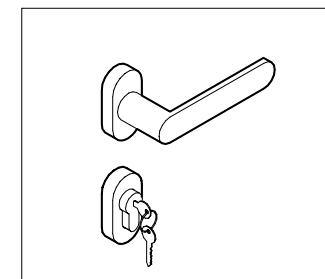

ML8

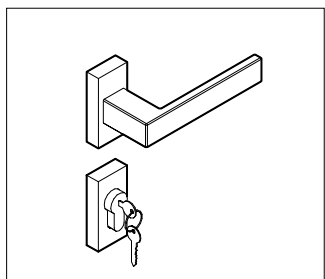

ML9

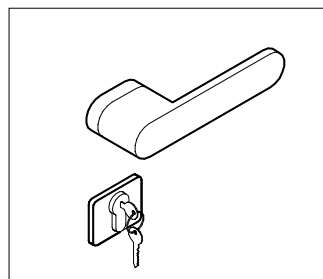

ML10

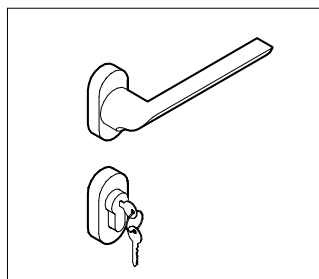

ML11

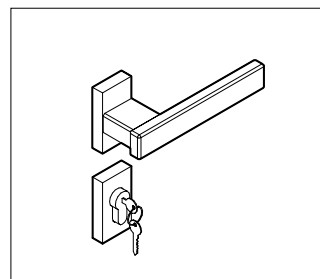

MLQ

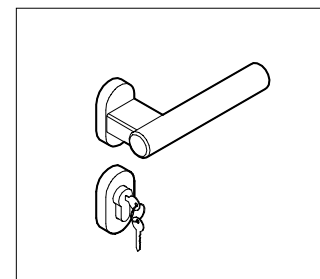

MLT

# ANTA INTELAIATA GRANDE sp. 43 mm

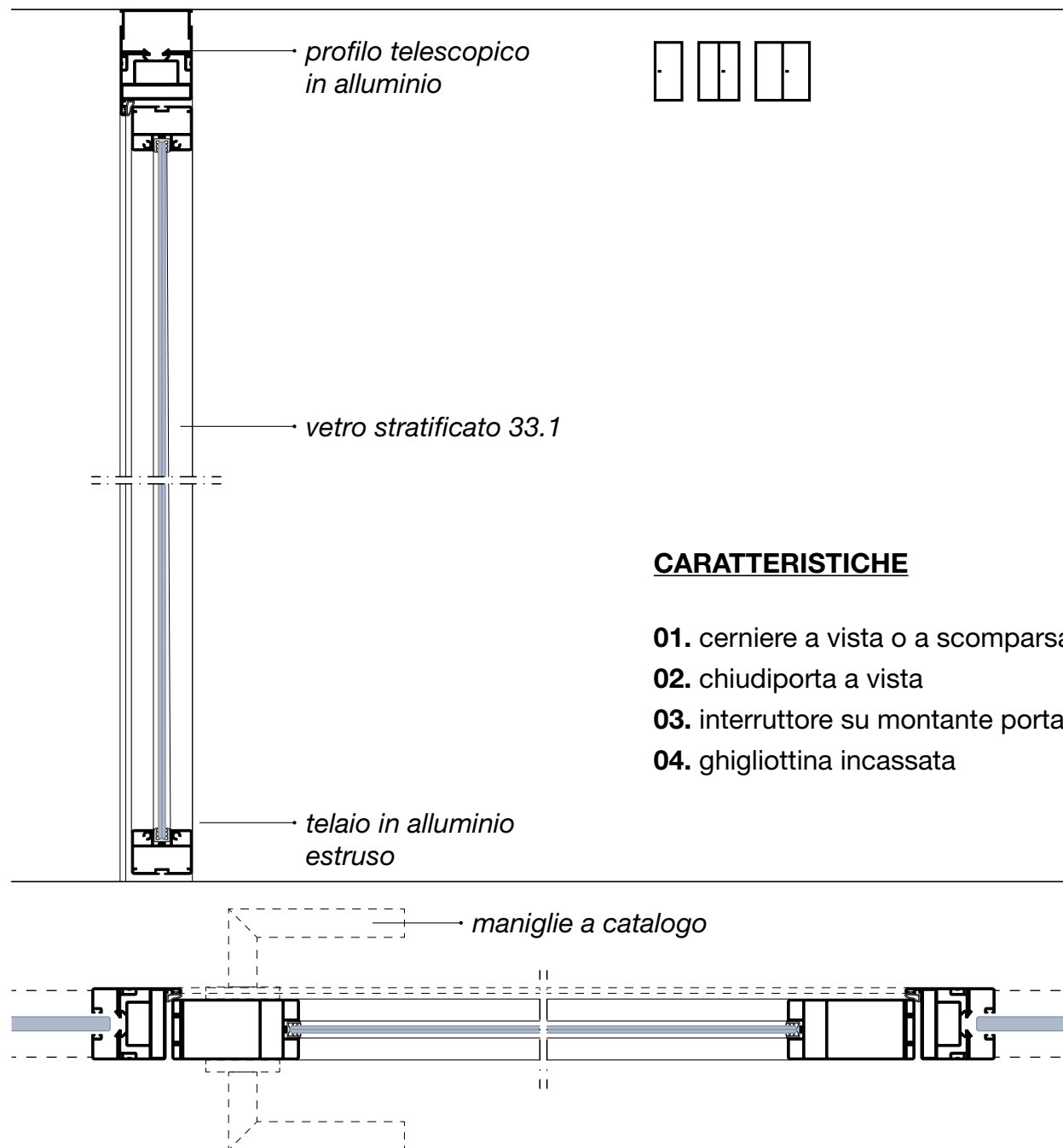
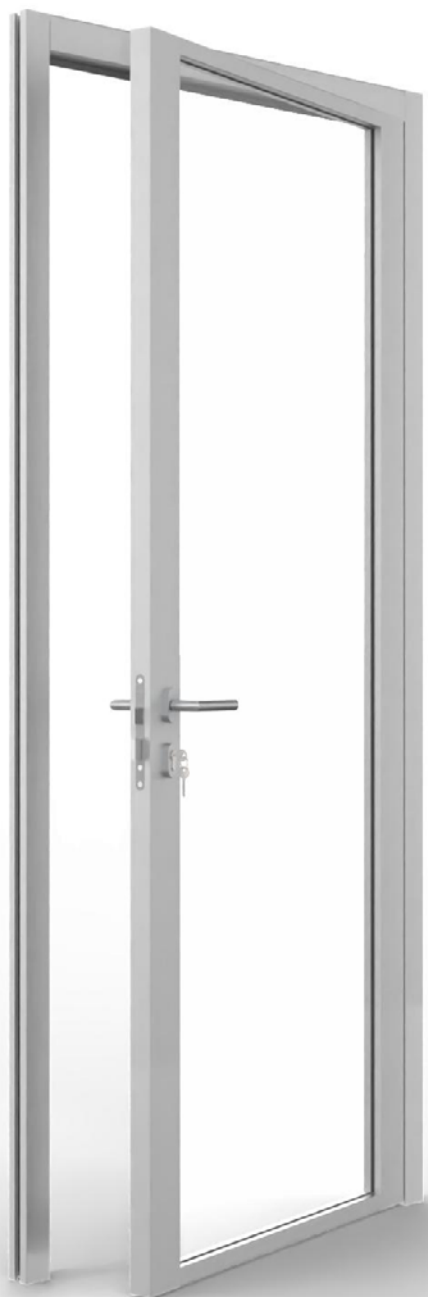

# ANTA INTELAIATA GRANDE sp. 43 mm

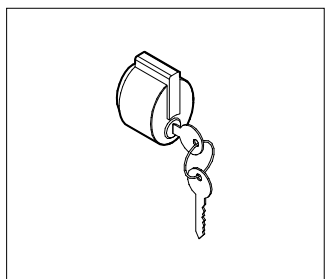

ML1

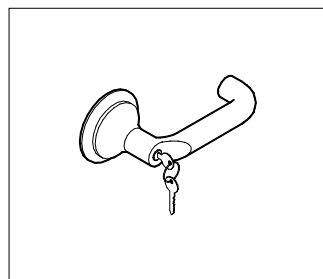

ML4

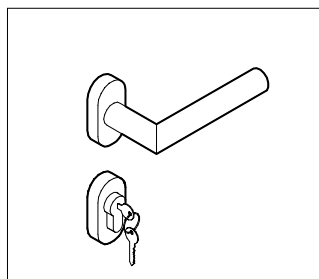

ML5

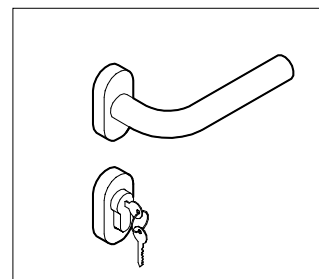

ML6

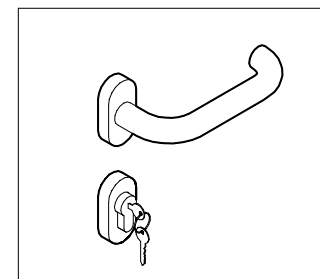

ML7

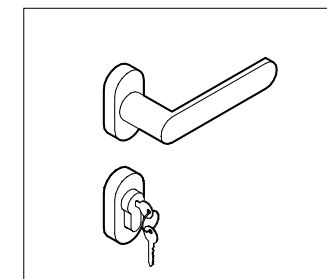

ML8

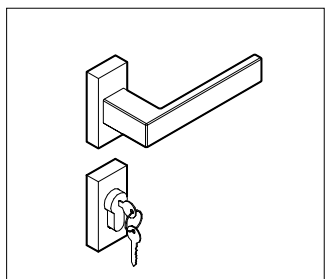

ML9

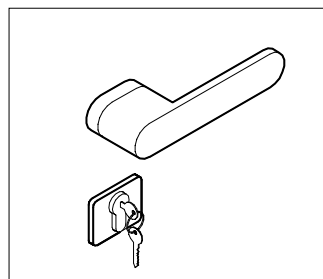

ML10

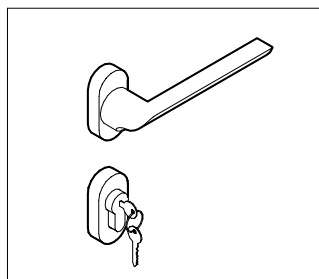

ML11

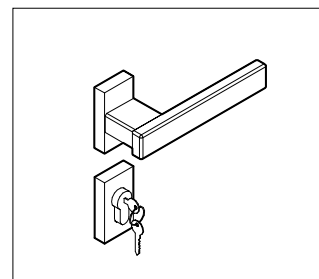

MLQ

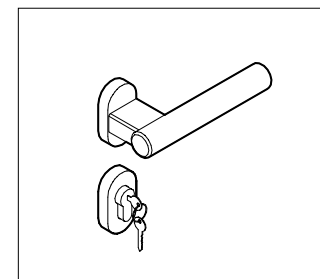

MLT

# ANTA INTELAIATA MEDIA sp. 43 mm

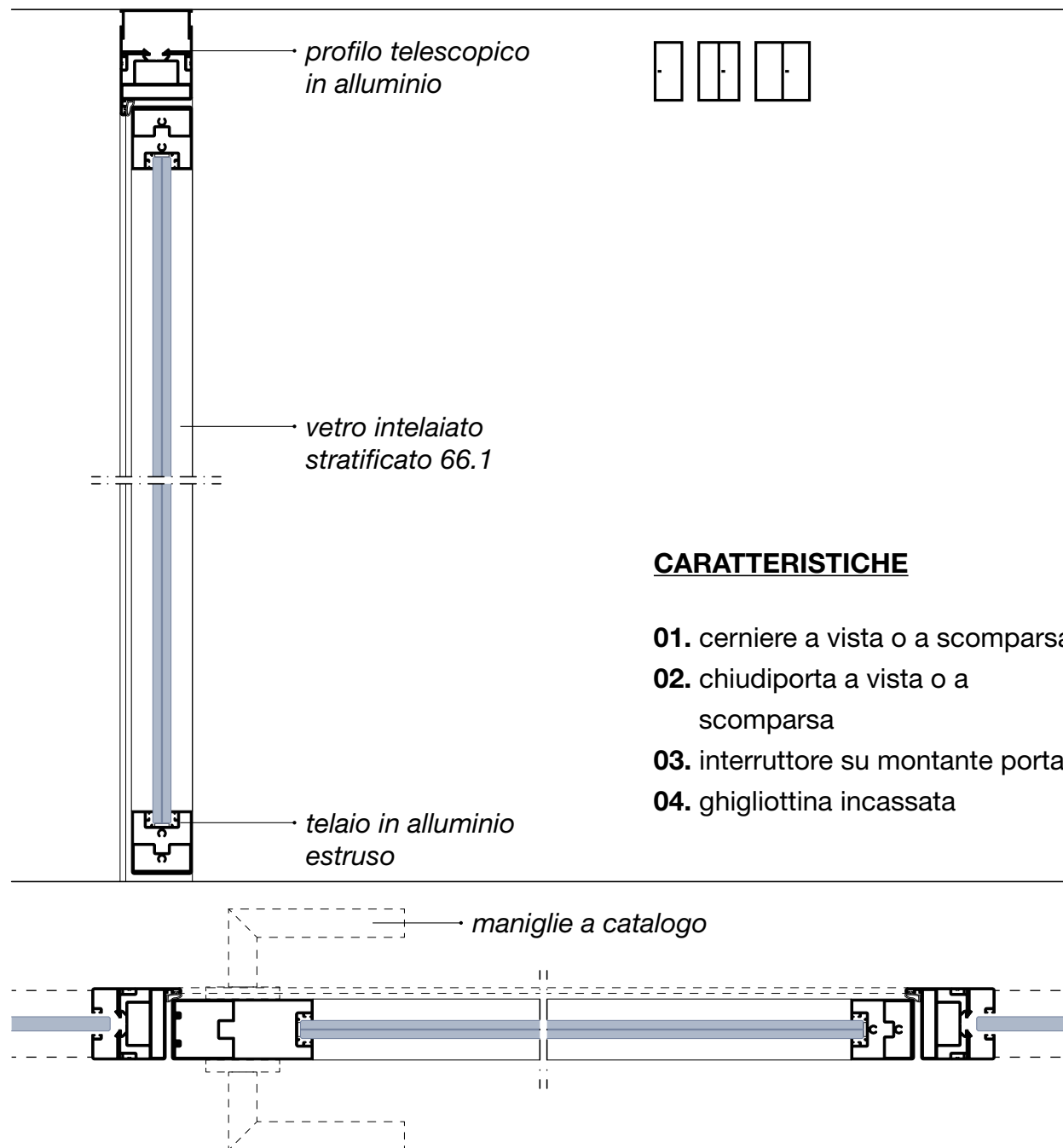

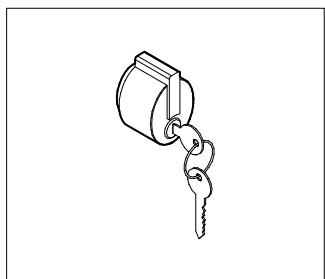

**ML1**

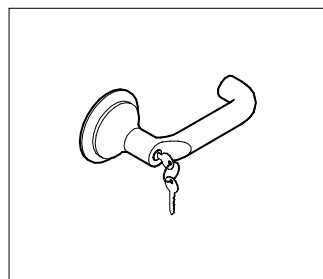

**ML4**

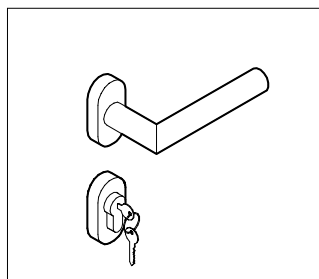

**ML5**

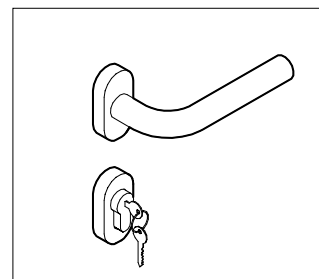

**ML6**

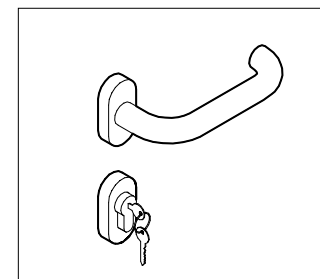

**ML7**

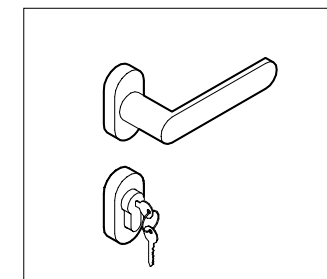

**ML8**

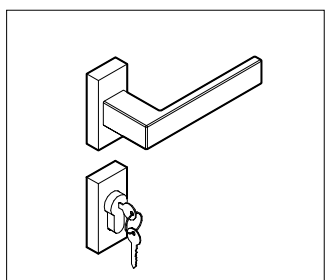

**ML9**

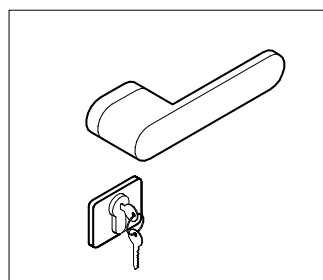

**ML10**

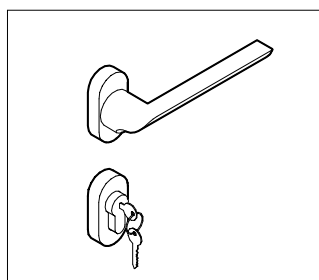

**ML11**

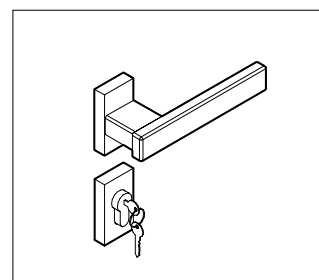

**MLQ**

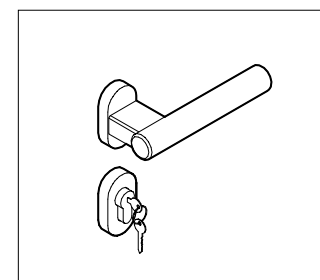

**MLT**

# ANTA INTELAIATA SOTTILE sp. 43 mm

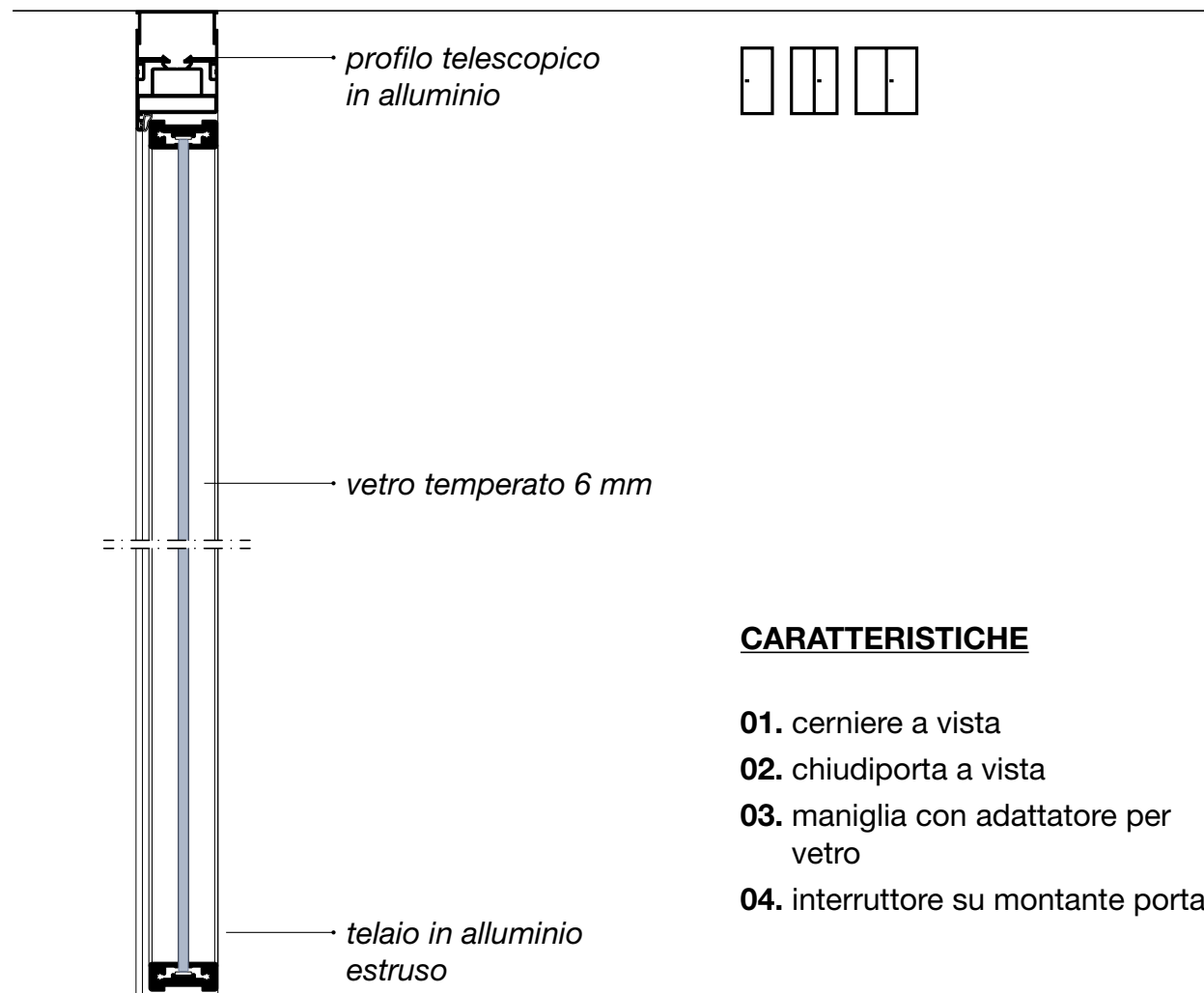

## **CARATTERISTICHE**

- 01.** cerniere a vista
- 02.** chiudiporta a vista
- 03.** maniglia con adattatore per vetro
- 04.** interruttore su montante porta

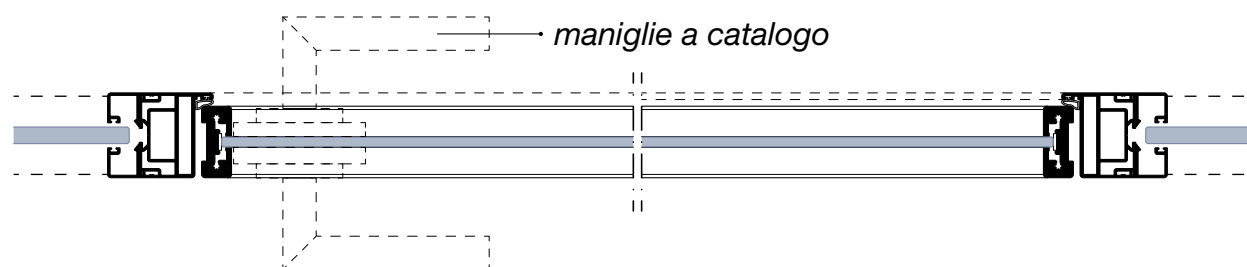

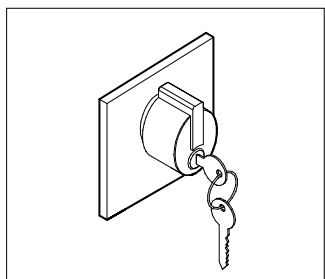

**ML1**

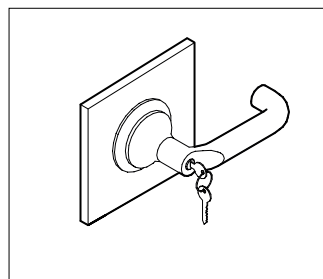

**ML4**

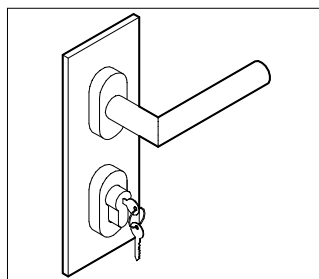

**ML5**

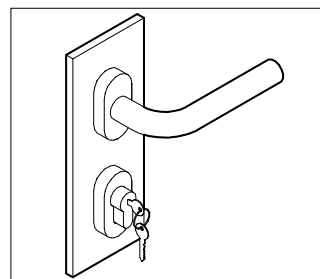

**ML6**

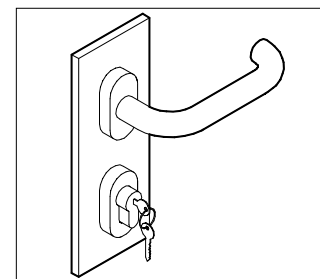

**ML7**

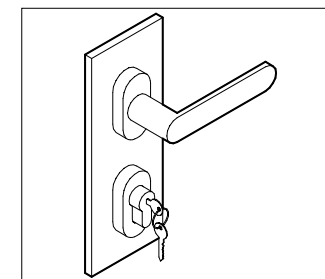

**ML8**

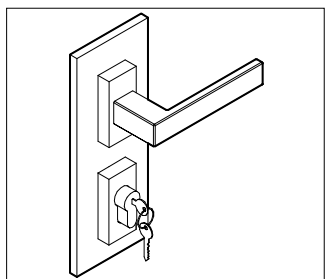

**ML9**

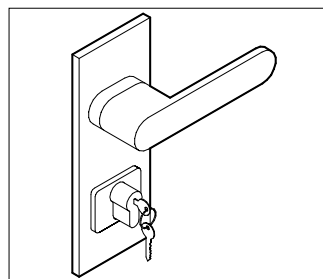

**ML10**

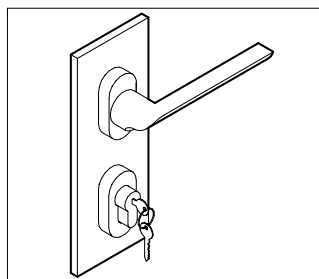

**ML11**

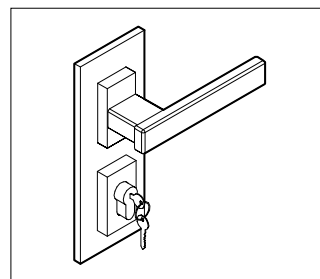

**MLQ**

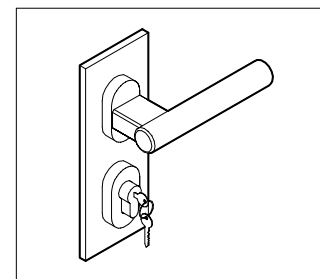

**MLT**



# ANTA INTELAIATA VETRO DOPPIO sp. 51 mm

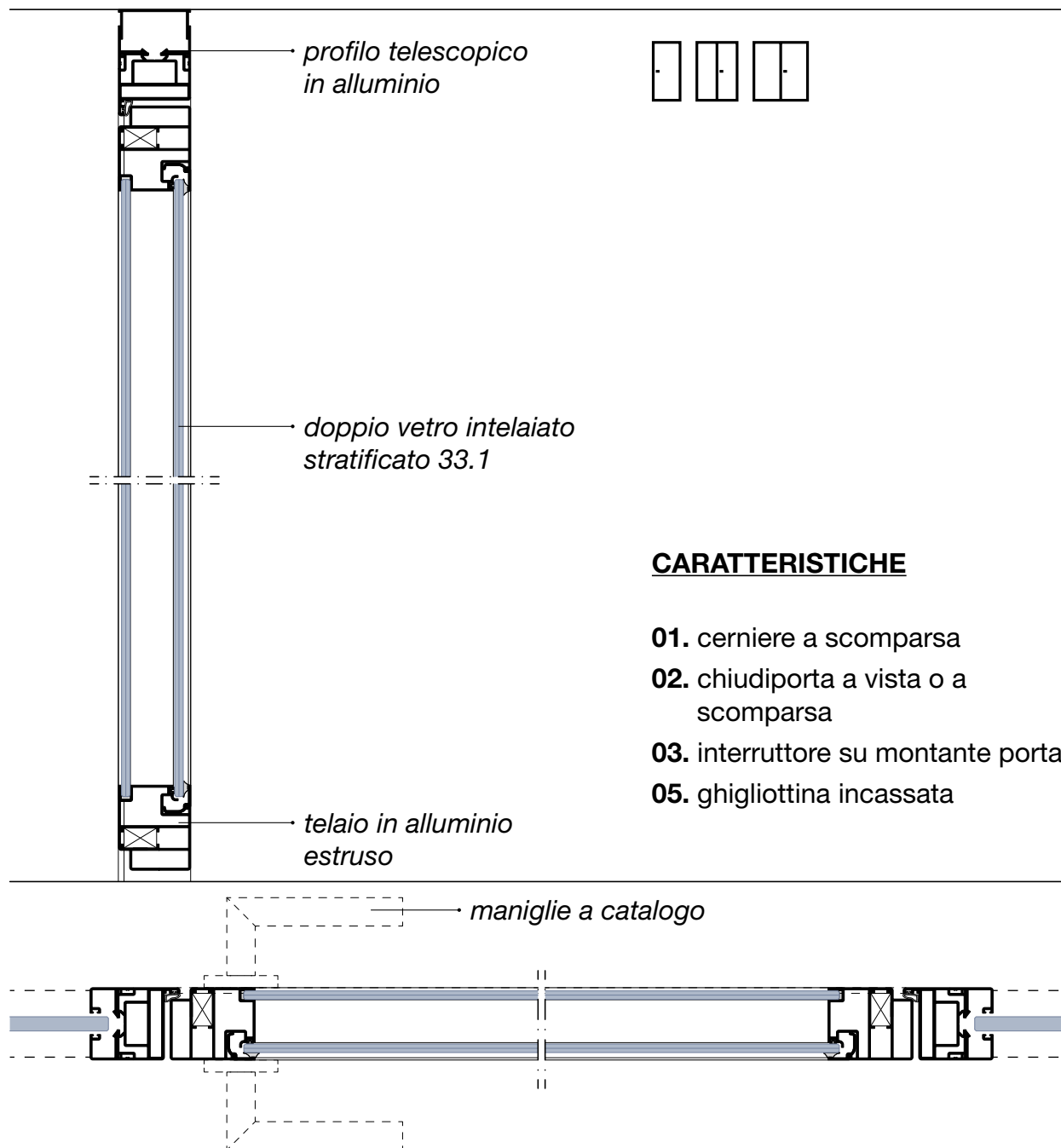

# ANTA INTELAIATA VETRO DOPPIO sp. 51 mm

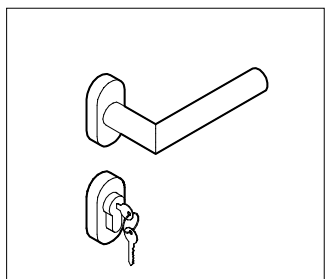

ML5

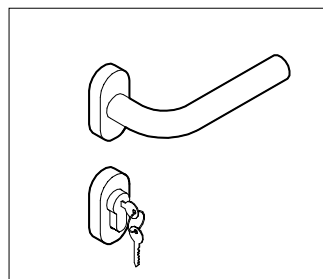

ML6

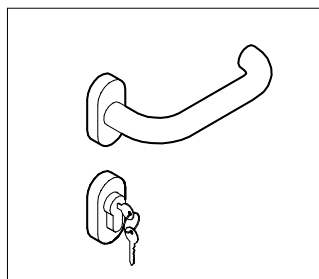

ML7

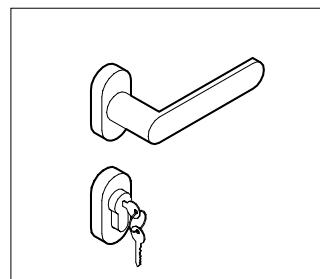

ML8

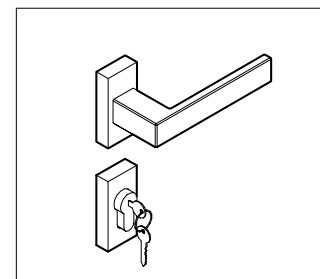

ML9

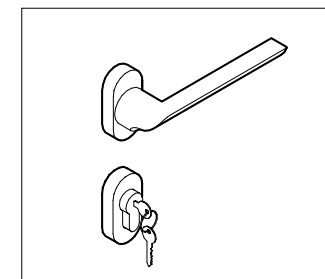

ML11

# TELAI PORTE SCORREVOLI



Telaio porta su **Unica Slim**

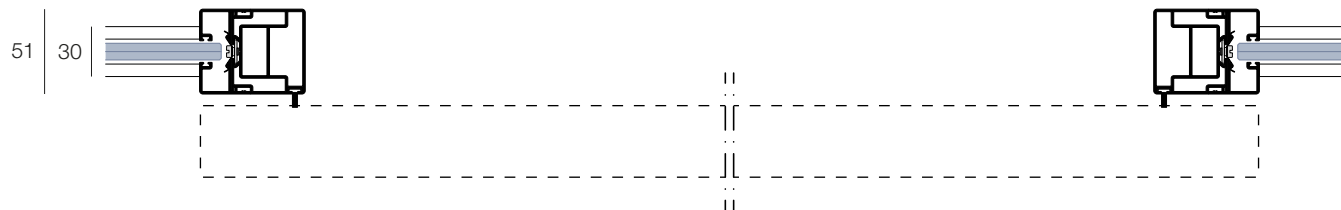

Telaio porta su **Unica U**

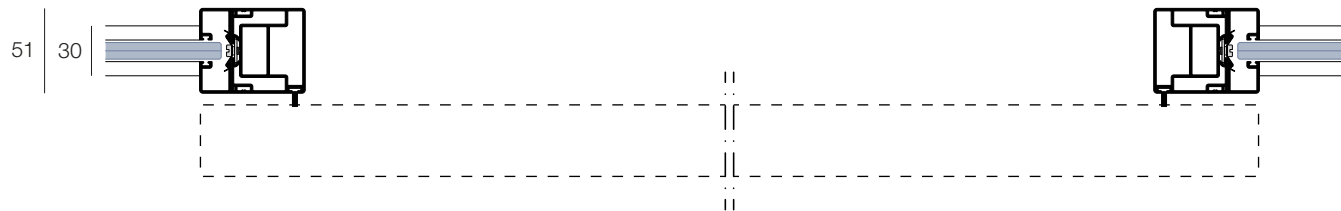

Telaio porta su **Unica SC1/SC2/SC3**

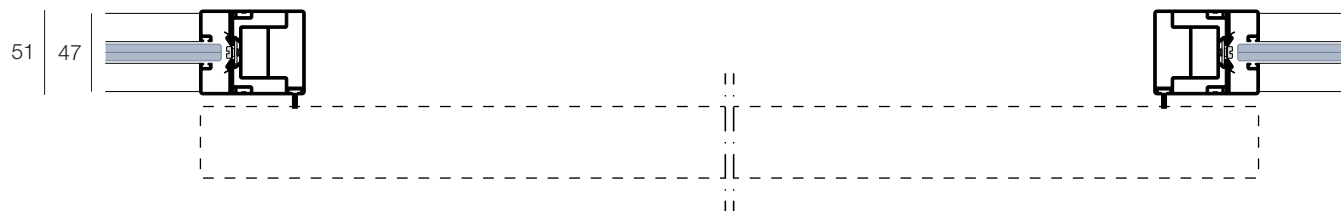

Telaio porta su **Unica R**

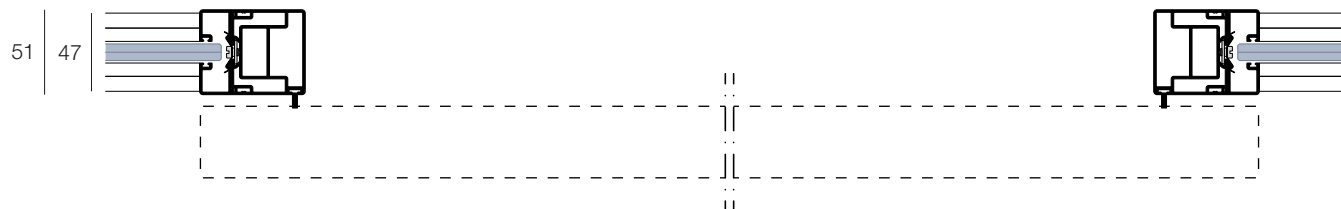

Telaio porta su **Unica D**

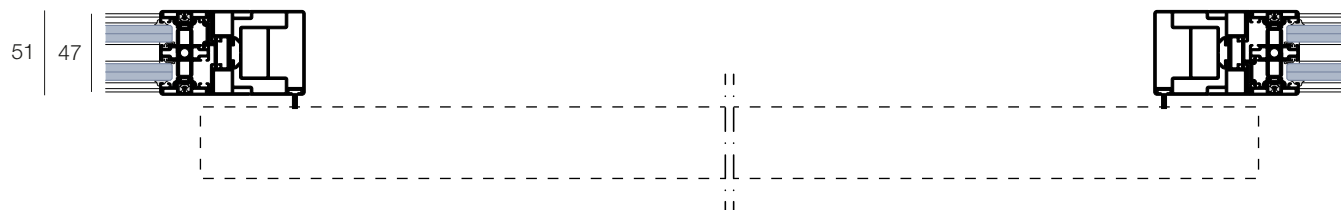

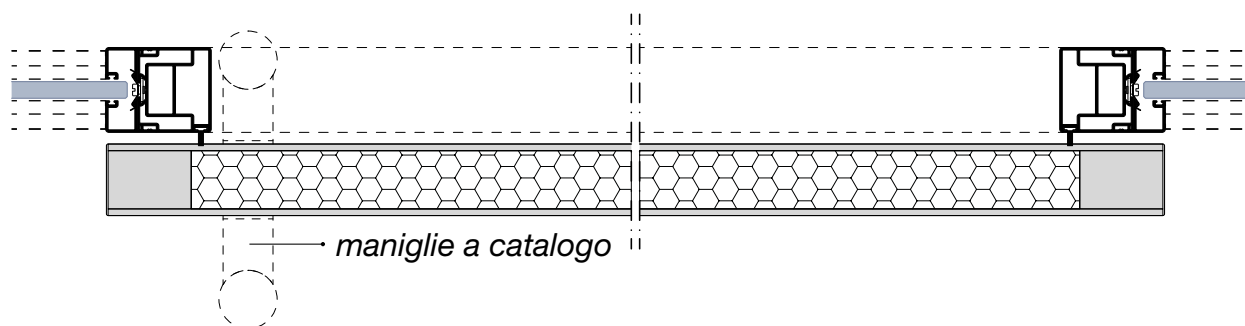
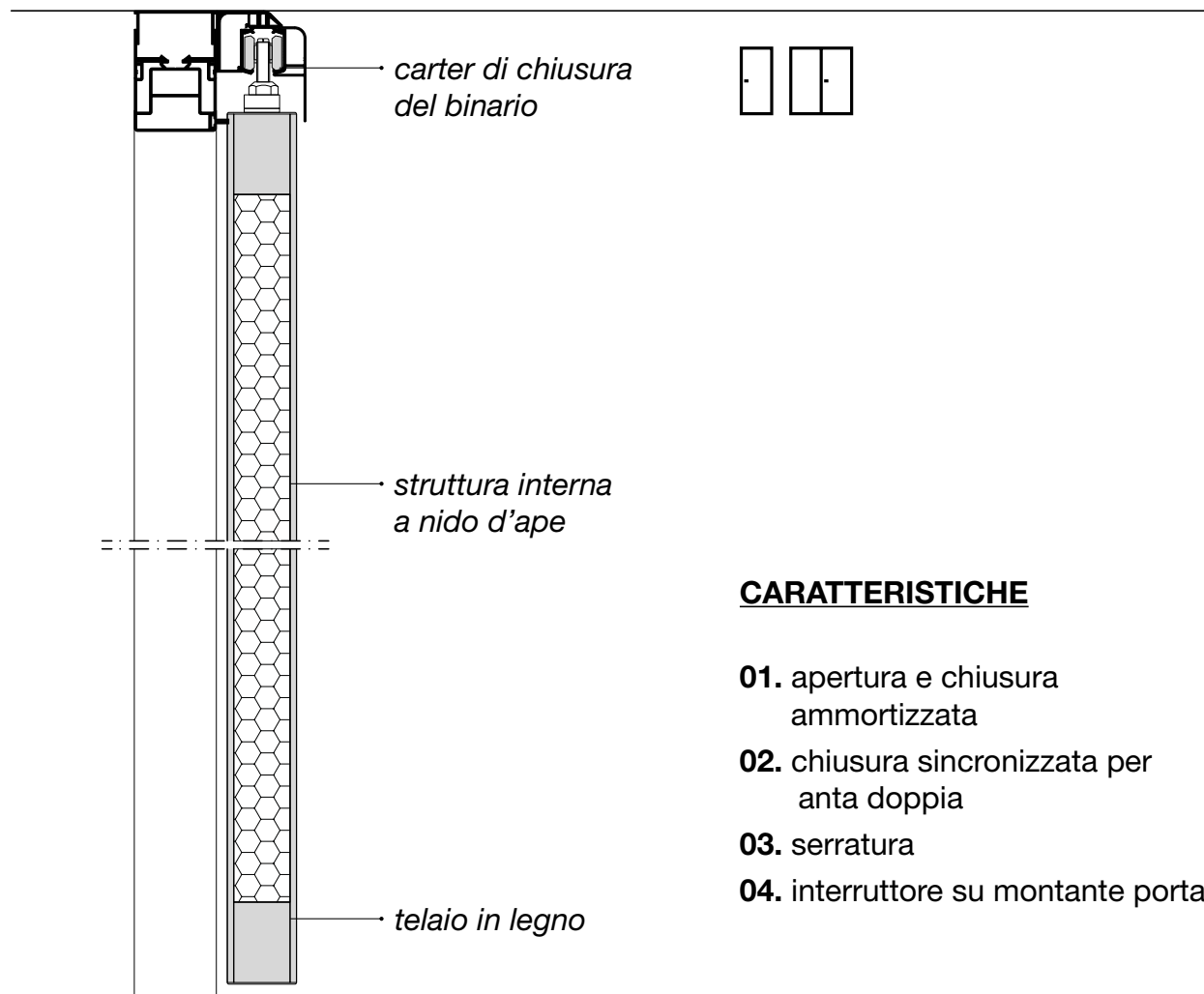

# ANTA VETRO TEMPERATO sp. 10 mm

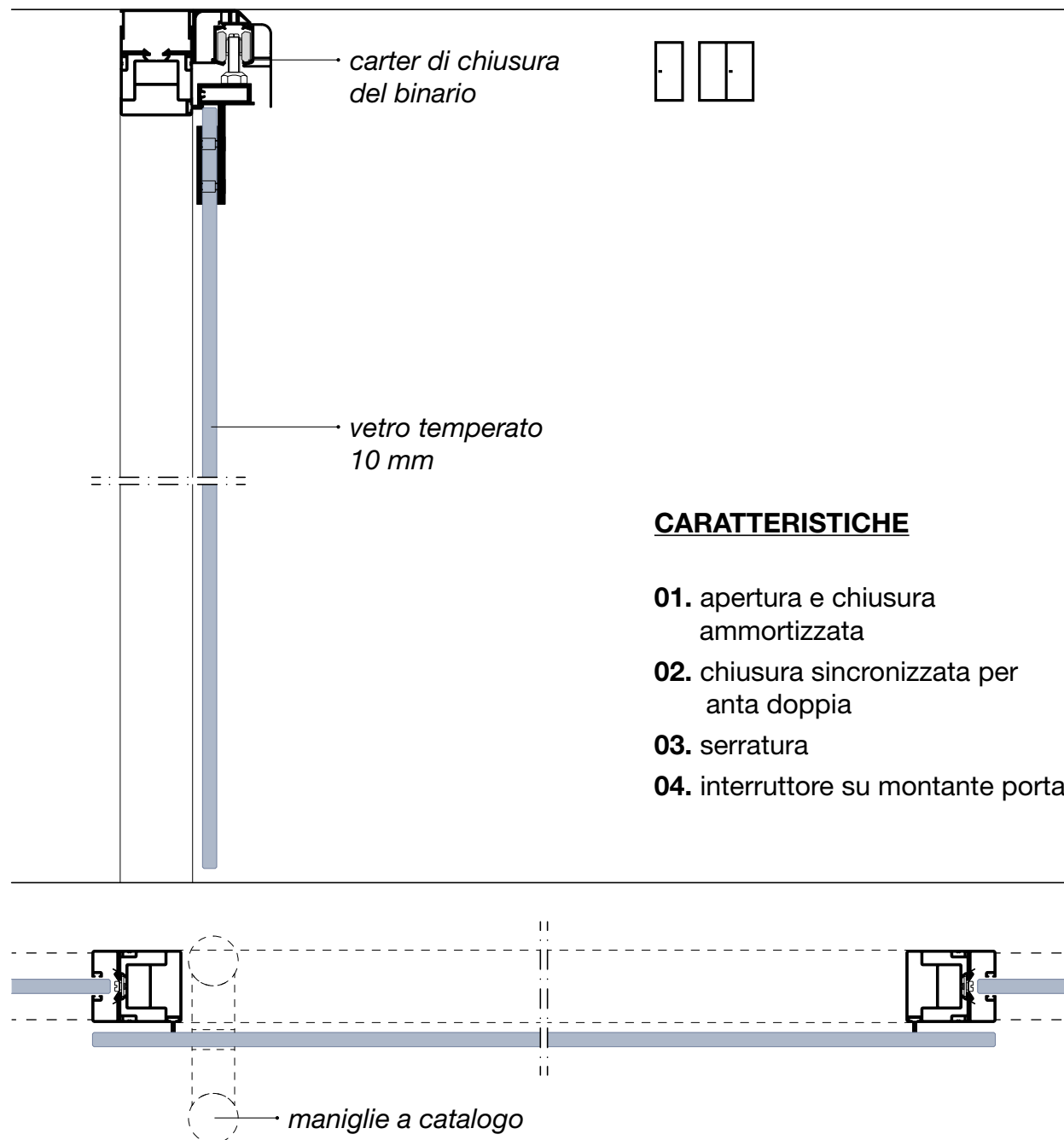

# ANTA INTELAIATA GRANDE sp. 43 mm

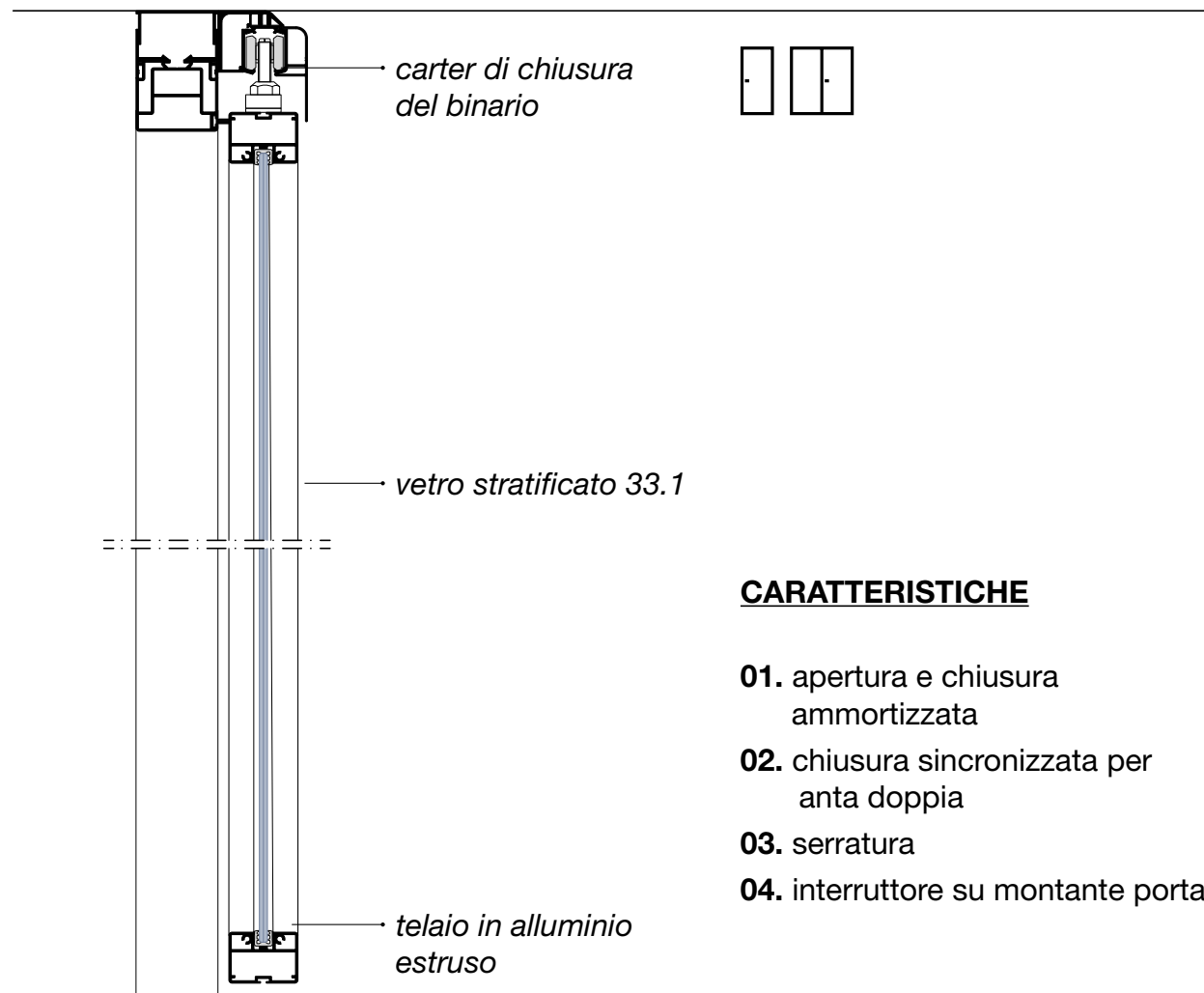

## CARATTERISTICHE

- 01. apertura e chiusura ammortizzata
- 02. chiusura sincronizzata per anta doppia
- 03. serratura
- 04. interruttore su montante porta

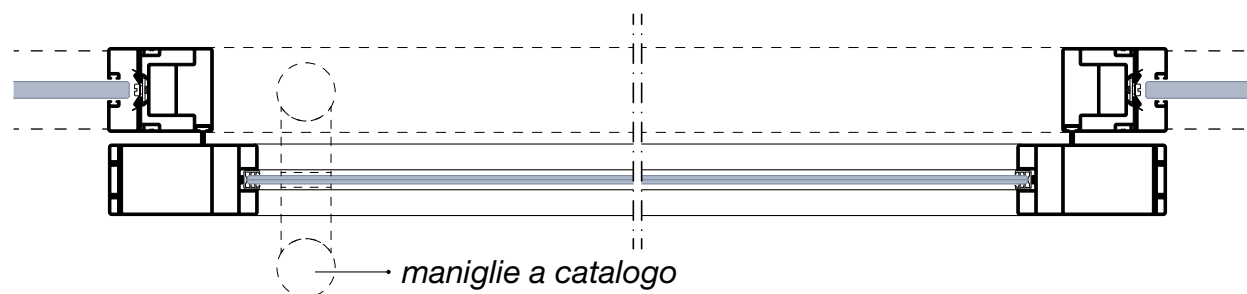

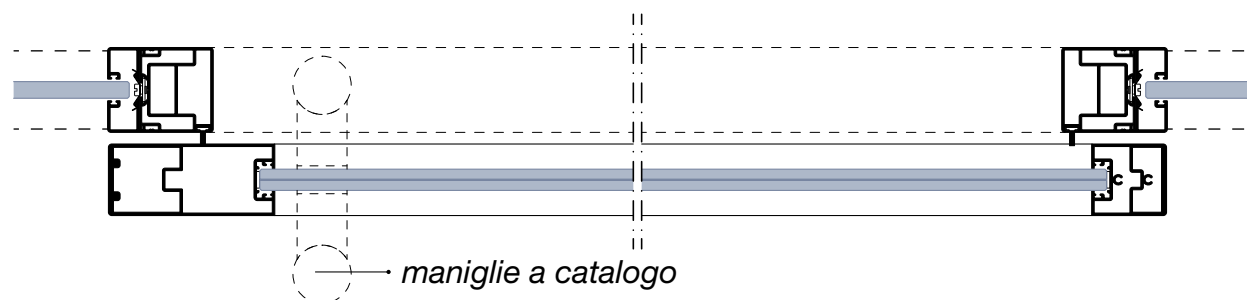
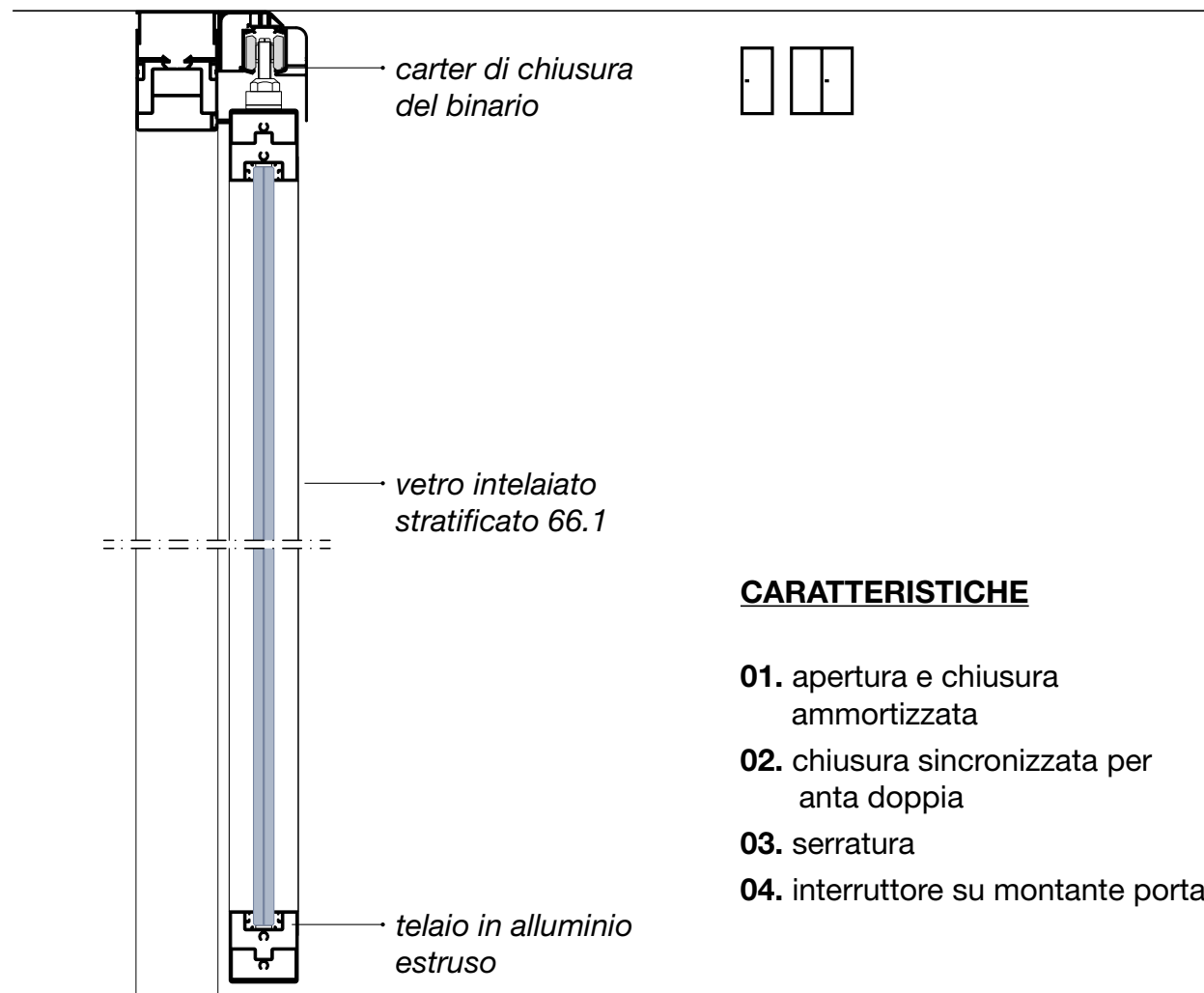
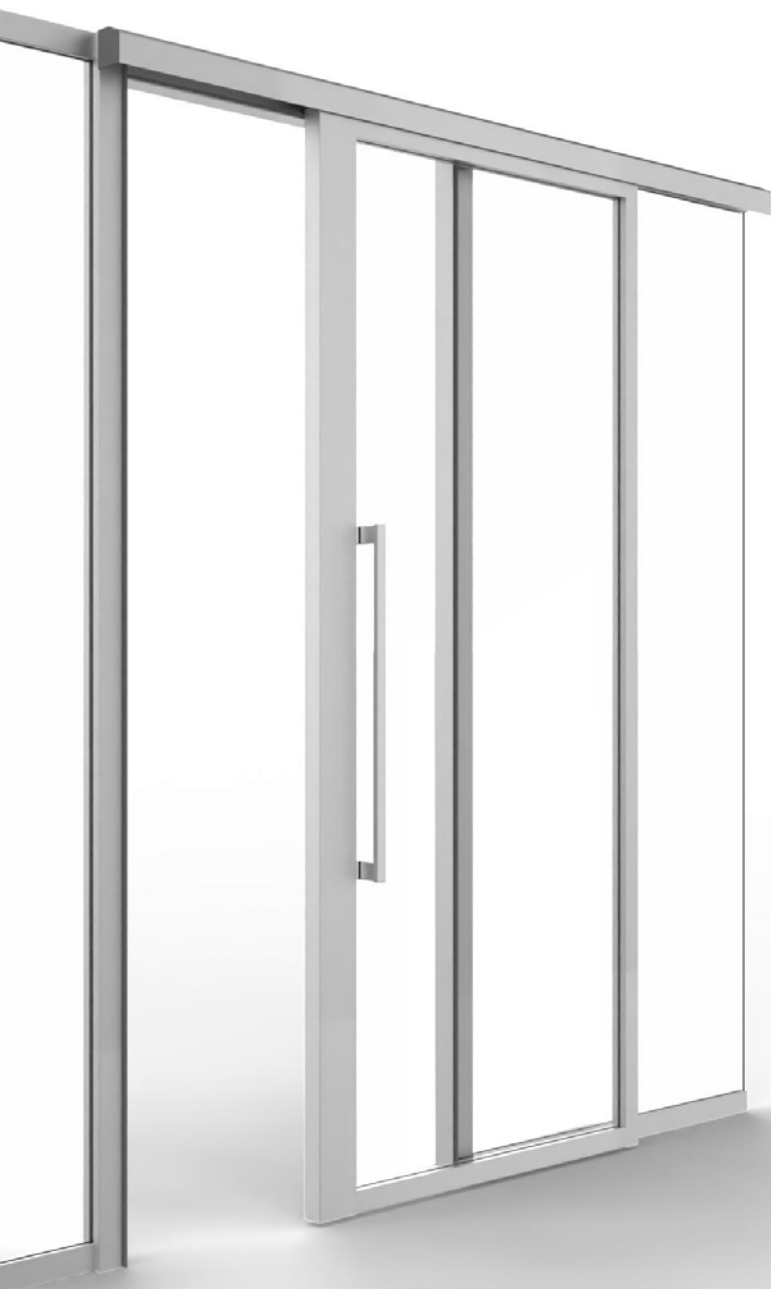

# ANTA INTELAIATA SOTTILE sp. 43 mm

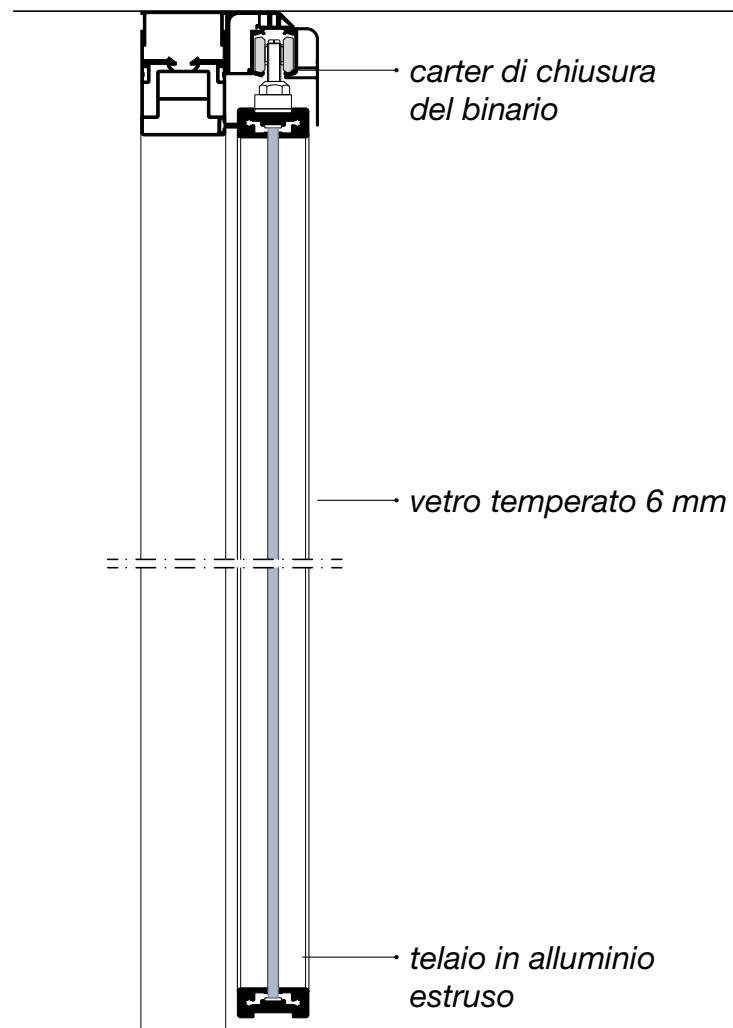

## CARATTERISTICHE

- 01. apertura e chiusura ammortizzata
- 02. chiusura sincronizzata per anta doppia
- 03. serratura
- 04. interruttore su montante porta

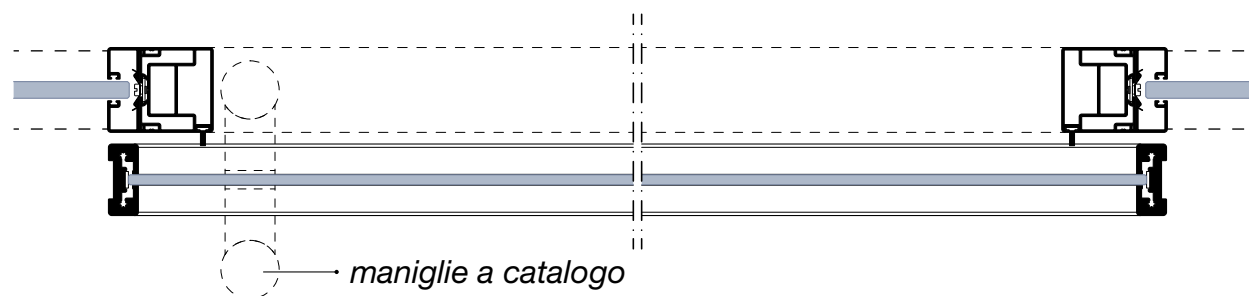



# Porte in vetro



ACCIAIO

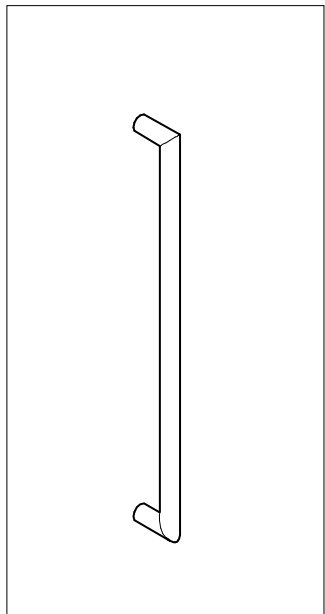

**MPOMGH1\_H2\_H3**

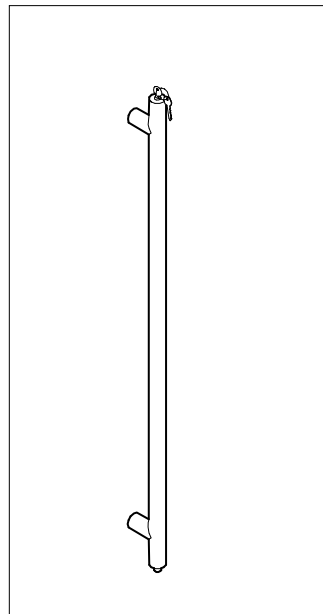

**MPOM2**

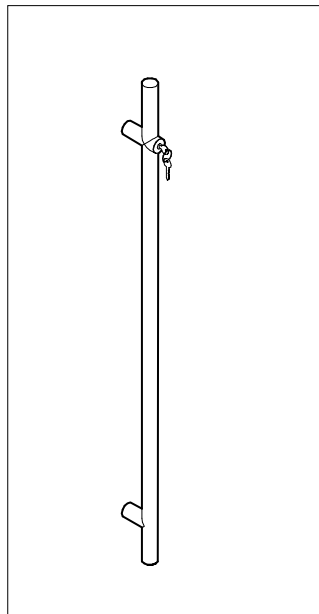

**MPOM3**

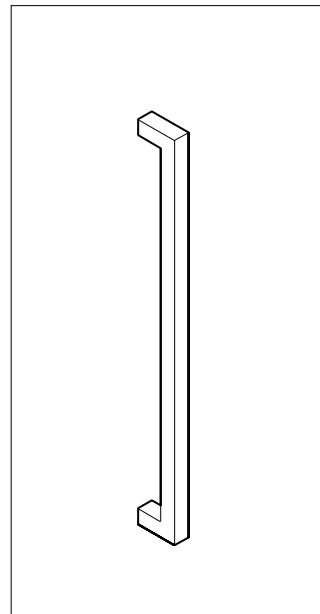

**MPOMGH1Q\_GH2Q\_GH3Q**

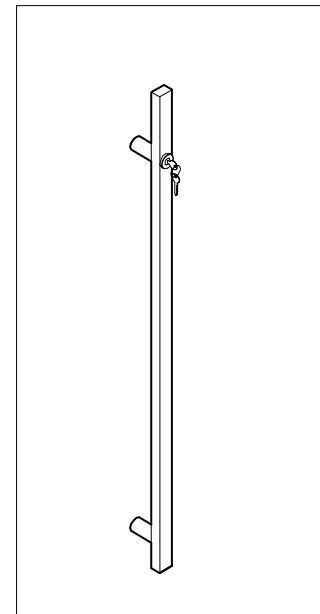

**MPOM3Q**

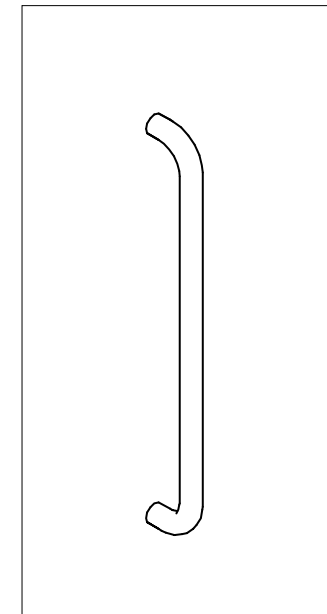

**MPOM8**

ALLUMINIO

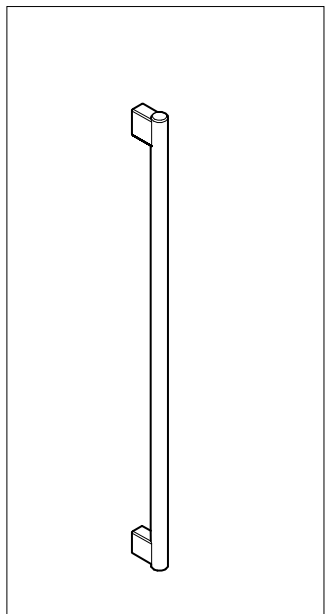

**MPOMTH1\_TH2**

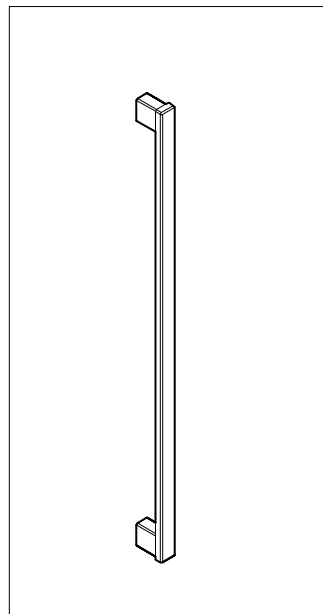

**MPOMQH1\_QH2**

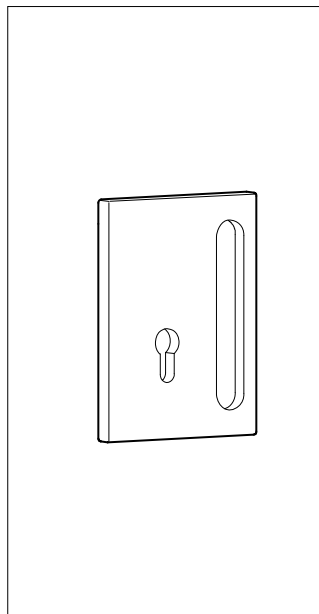

**MPOM6**

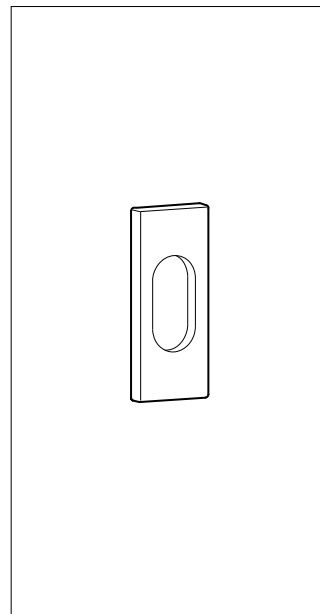

**MPOM7**

# Porte cieche



ACCIAIO

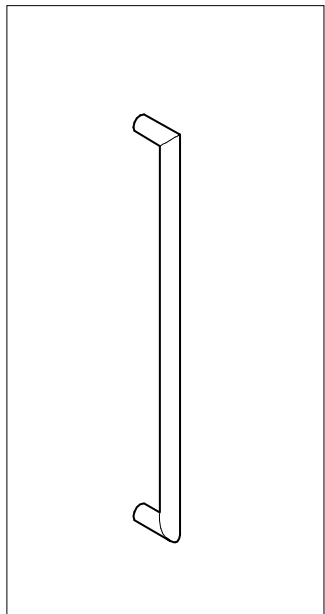

**MPOMGH1\_H2\_H3**

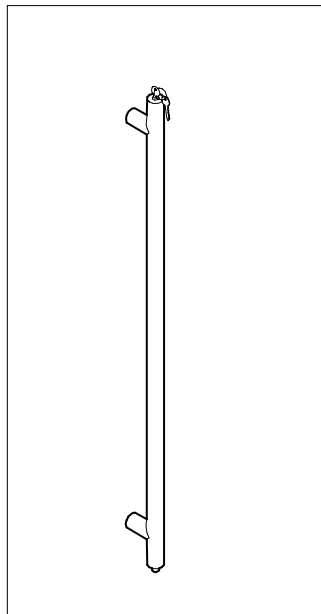

**MPOM2**

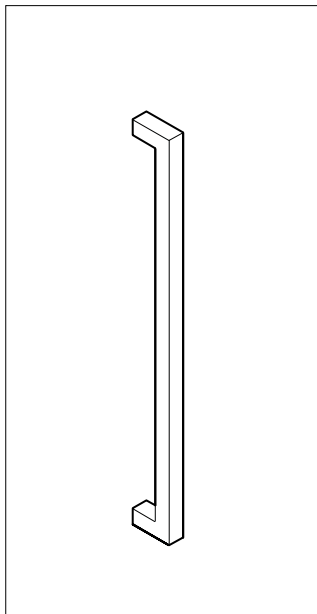

**MPOMGH1Q\_GH2Q\_GH3Q**

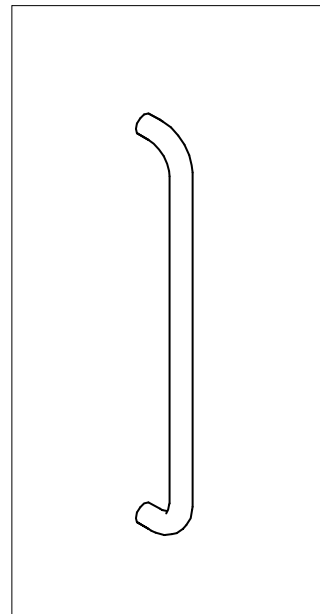

**MPOM8**

ALLUMINIO

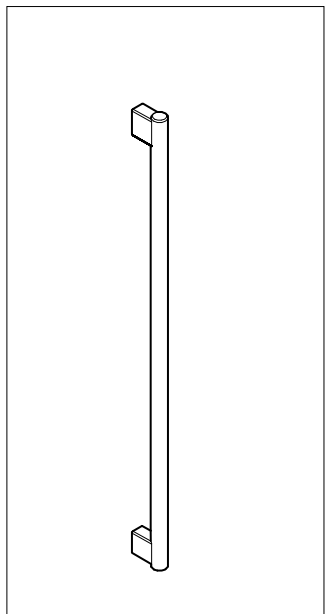

**MPOMTH1\_TH2**

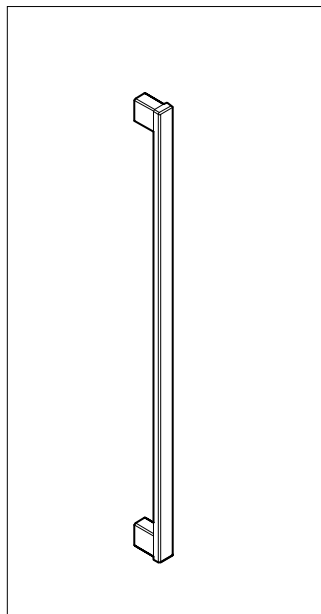

**MPOMQH1\_QH2**

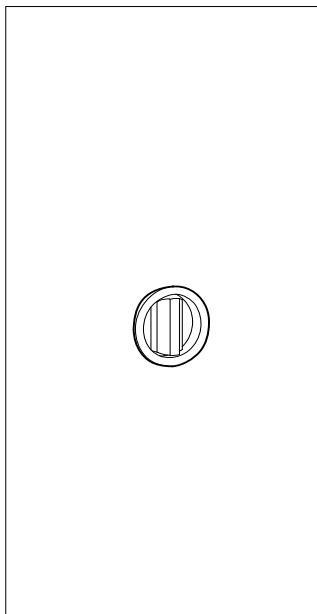

**MPOM4**

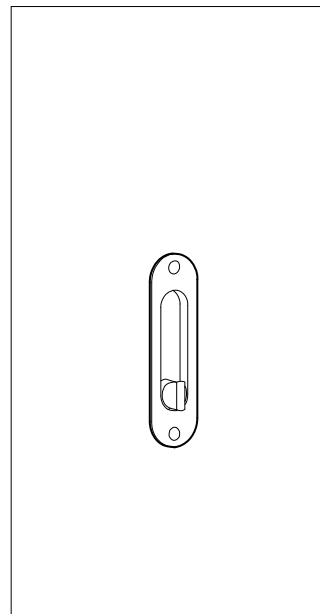

**MPOM5**

**UNICA®**

Accessori

---



## Chiudiporta aerei

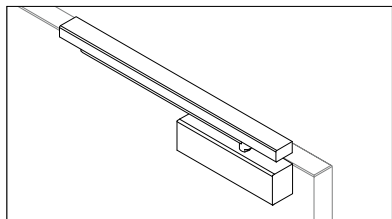

**01 esterno a slitta**  
*per anta cieca/intelaiata*

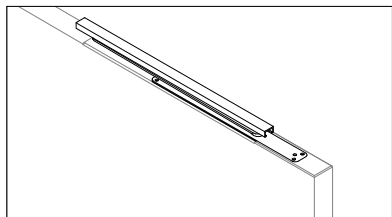

**02 a scomparsa**  
*per anta cieca/intelaiata*

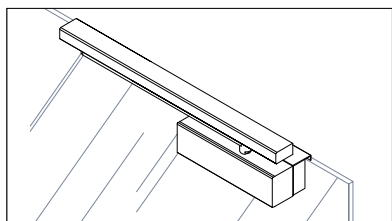

**03 esterno a slitta con supporto**  
*per anta in vetro temperato*

## Chiudiporta a terra

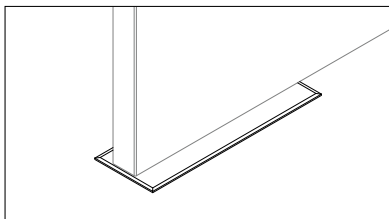

**01 a pavimento**  
*per anta cieca*

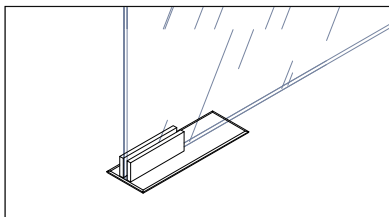

**02 a pavimento**  
*per anta in vetro temperato*

## Cerniere in alluminio

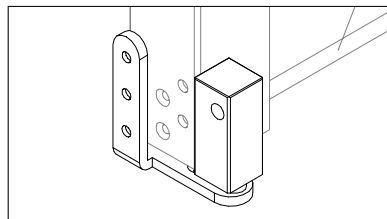

**01 a bilico esterno**  
*per anta cieca/intelaiata*

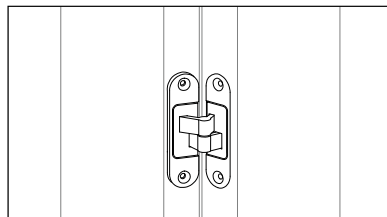

**02 a scomparsa**  
*per anta cieca/intelaiata*

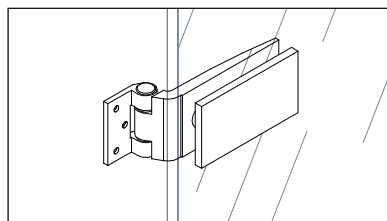

**03 apertura 180°**  
*per anta in vetro temperato*

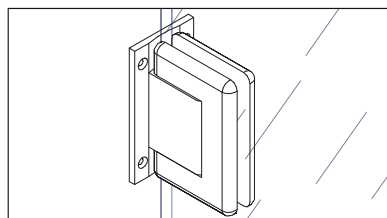

**04 va e vieni velocità regolabile**  
*per anta in vetro temperato*

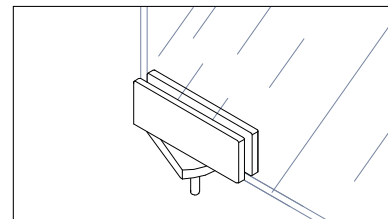

**05 va e vieni velocità regolabile**  
*per anta in vetro temperato*

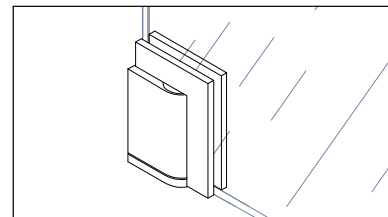

**06 va e vieni velocità regolabile**  
*per anta in vetro temperato*

## Accessori

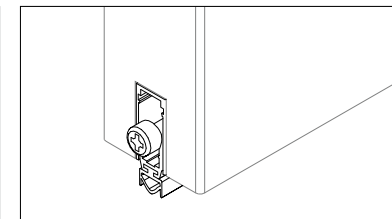

**01 antispiffero insonorizzante**  
*per anta cieca/intelaiata*

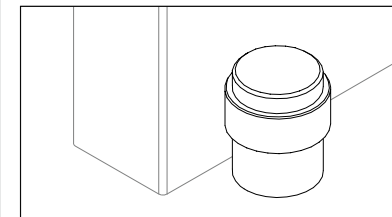

**02 fermaporte**  
*per anta cieca/intelaiata/vetro temperato*

**UNICA®**

Finiture

---



**Anodizzati**

**Finiture RAL**

**Lucidatura**

**Legni**



**01** Alluminio naturale



**01** Bianco

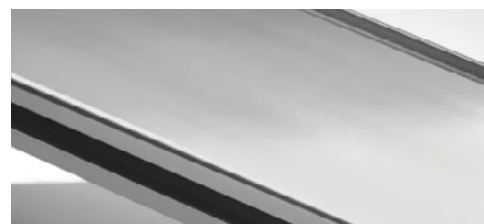

**01** Brillantato



**01** Rovere chiaro



**02** Bronzo

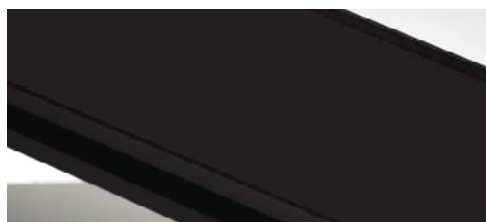

**02** Nero

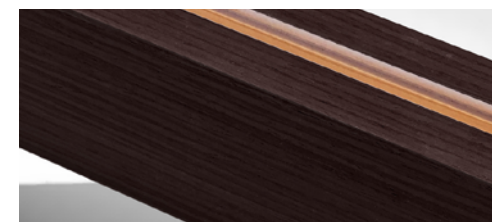

**02** Rovere scuro

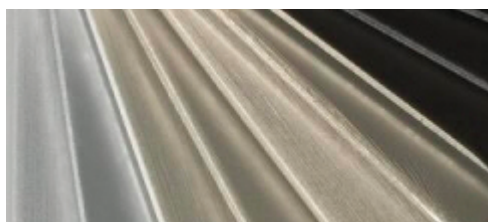

**03** Colore a campione



**03** Colore a campione

# Pannelli ciechi



CAT. 1

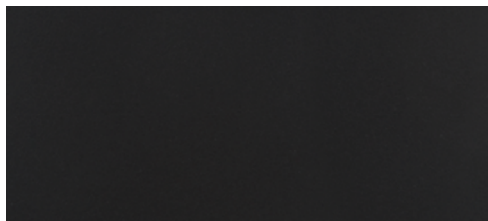

**055** Nero grafite

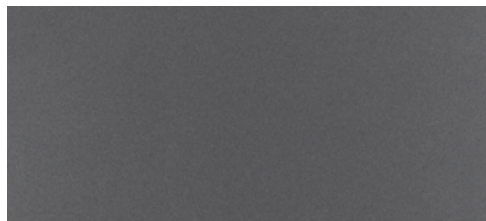

**420** Piombo



**418** Grigio cenere

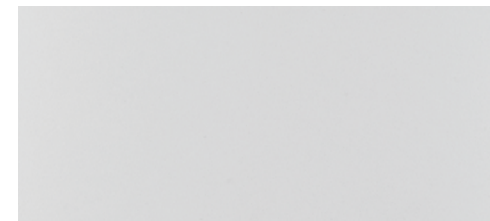

**419** Grigio chiaro

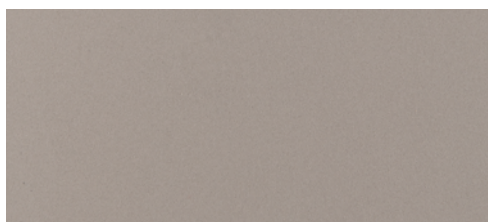

**393** Tortora



**417** Vaniglia

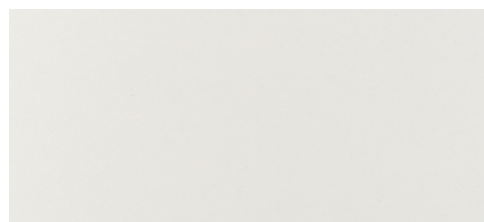

**429** Bianco caldo

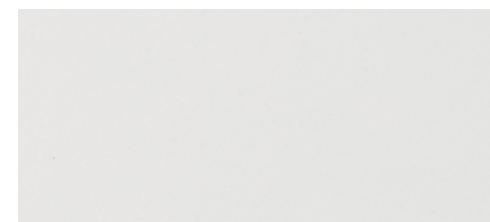

**428** Bianco freddo

CAT. 2

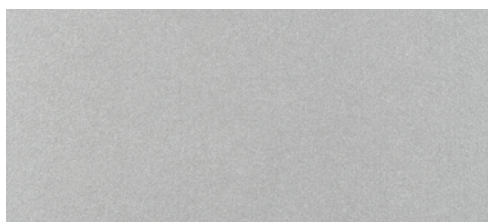

**422** Argento

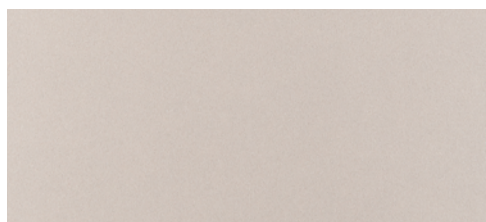

**423** Champagne





CAT. 1

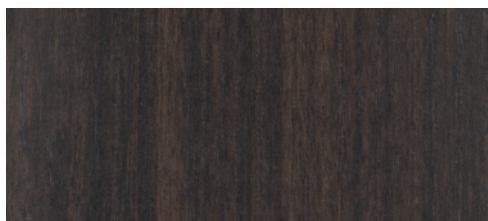

**421** Eucalipto

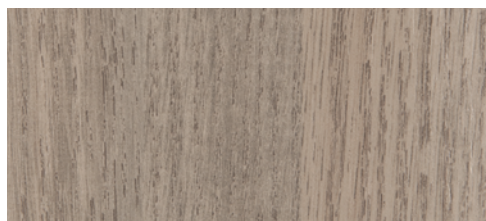

**426** Rovere medio



**274** Acacia



**416** Bianco venato

CAT. 2

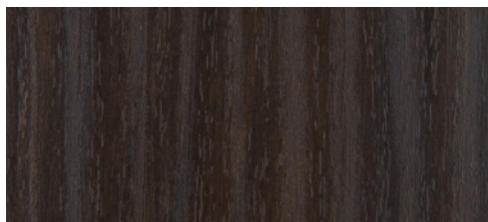

**425** Noce scuro

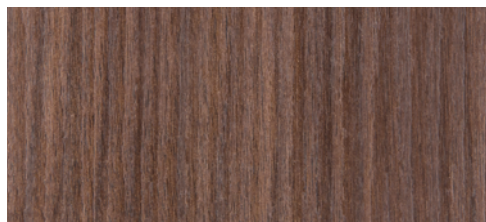

**318** Noce medio

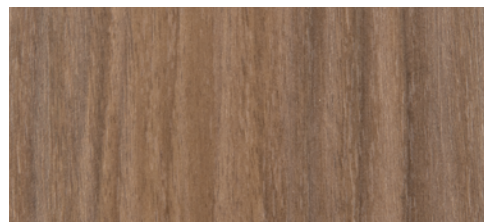

**427** Noce chiaro

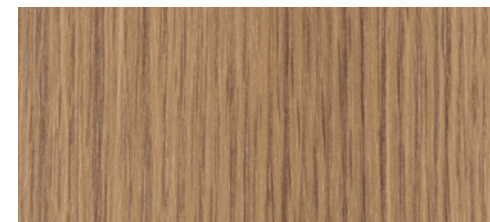

**382** Rovere naturale

CAT. 3



**138** Rovere invecchiato - taglio seta

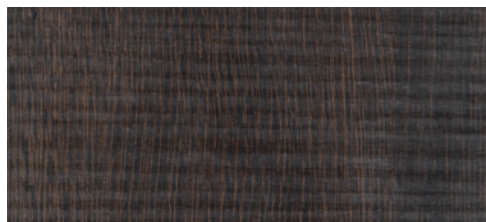

**197** Eucalipto - taglio seta

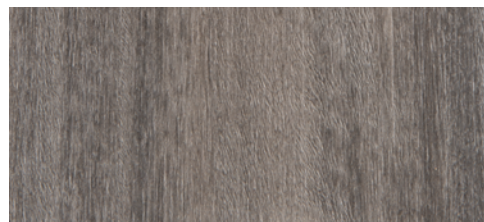

**408** Rovere grigio

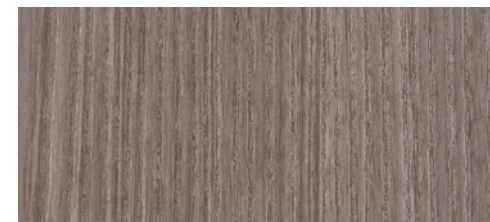

**400** Rovere Danubio

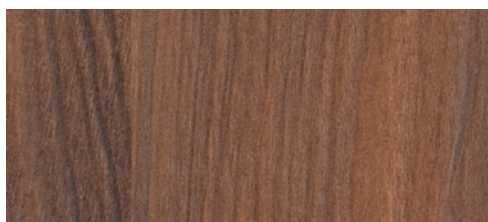

**414** Noce rosso

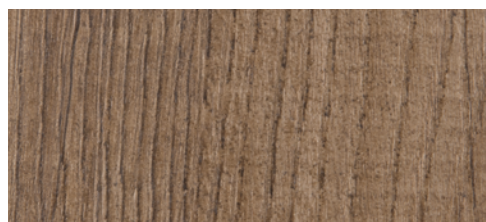

**412** Rovere vintage



**413** Rovere champagne



**410** Rovere chiaro





CAT. 2

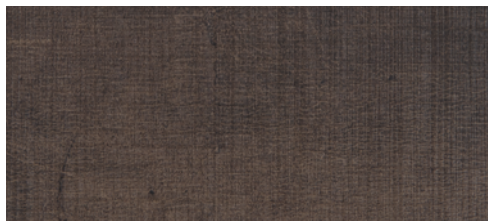

**304** Tessuto scuro



**123** Tessuto medio

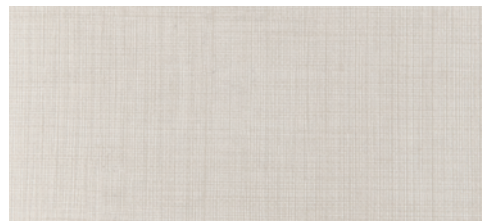

**305** Tessuto chiaro



**424** Ossido

CAT. 3

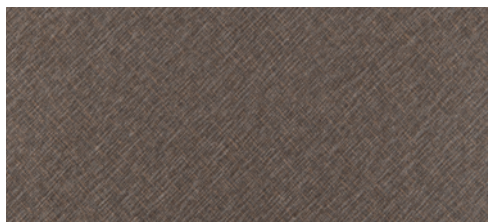

**385** Lino bronzo

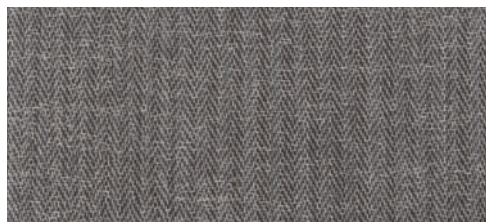

**409** Corteccia

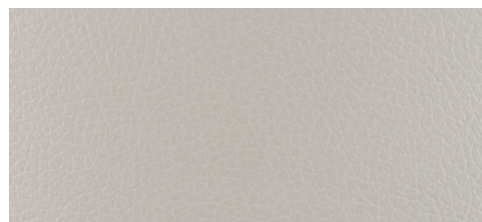

**406** Primo fiore grigio

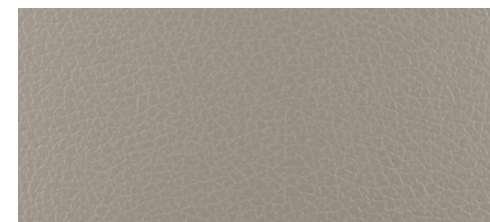

**405** Primo fiore tortora



**404** Primo fiore beige

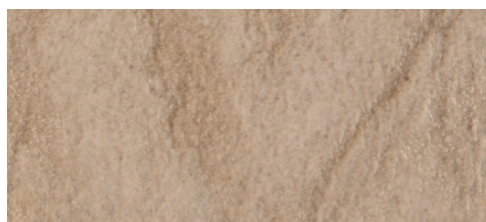

**415** Deserto



**01** Trasparente



**03** Satinato

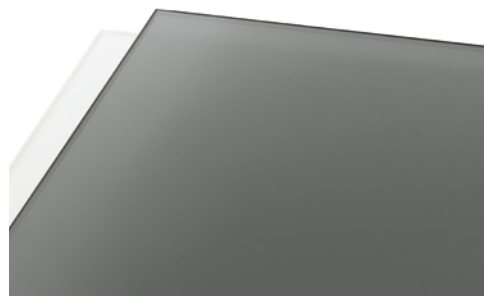

**05** Fumé



**02** Extrachiaro

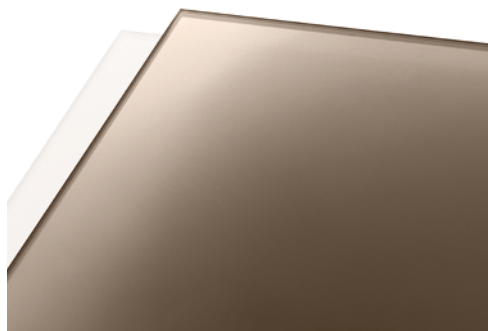

**04** Bronzo



**06** Verniciato a campione



**Etoile s.r.l. - Società Unipersonale**

Via D. Albertario, 50 61032 Zona Ind.le Bellocchi - Fano ( PU ) Italy  
P. +39.0721.85.59.34 - F. +39.0721.85.92.14  
info@etoilesrl.it - www.etoilesrl.it