



☐ ETOILE

UNICA® U





- 01.** Spessore 51 mm
- 02.** Profilo fermavetro - dimensioni 30 x 50 mm
- 03.** Profili a pavimento, a soffitto, angoli e partenze in estruso di alluminio 6060 UNI 9006/1
- 04.** Vetro singolo centrale - spessore 55.1/55.2 o temperato 10 mm
- 05.** Pannello cieco in vari formati autoportante o ancorato al vetro
- 06.** Profili d'angolo fissi e variabili - connessioni 2/3/4 vie
- 07.** Giunzioni verticali tra elementi vetrati in alluminio, policarbonato e biadesivo trasparente
- 08.** Telaio porta cablabile
- 09.** Modulo tecnico ispezionabile
- 10.** 7 versioni di porte battenti - cieche, in vetro temperato e intelaiate
- 11.** 5 versioni di porte scorrevoli esterne - cieche, in vetro temperato e intelaiate

01. Vetro 55.1 - **32 dB**

02. Vetro 55 + 0,5 PVB acustico + isolante - **35 dB**



Partenze

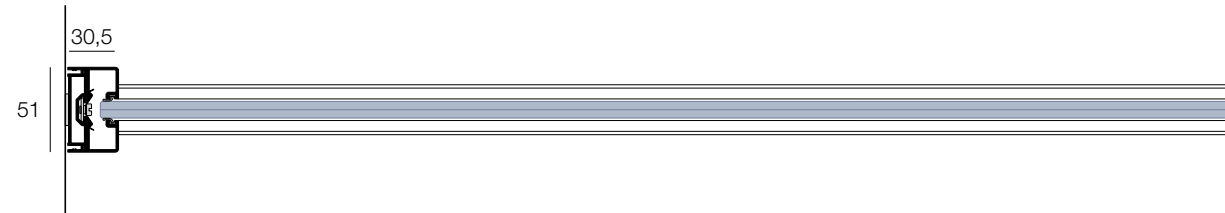
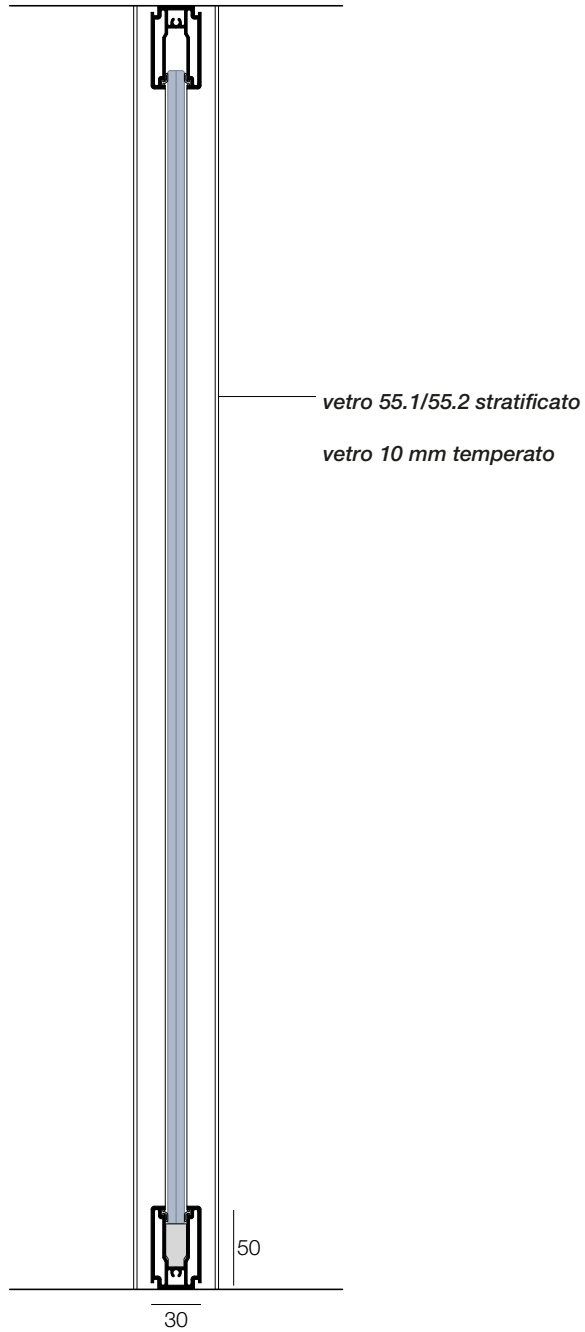

Partenza fissa da parete

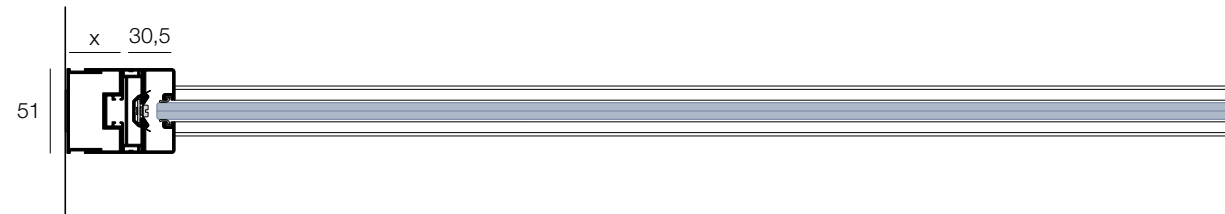

Partenza telescopica da parete

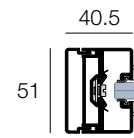

Profilo terminale

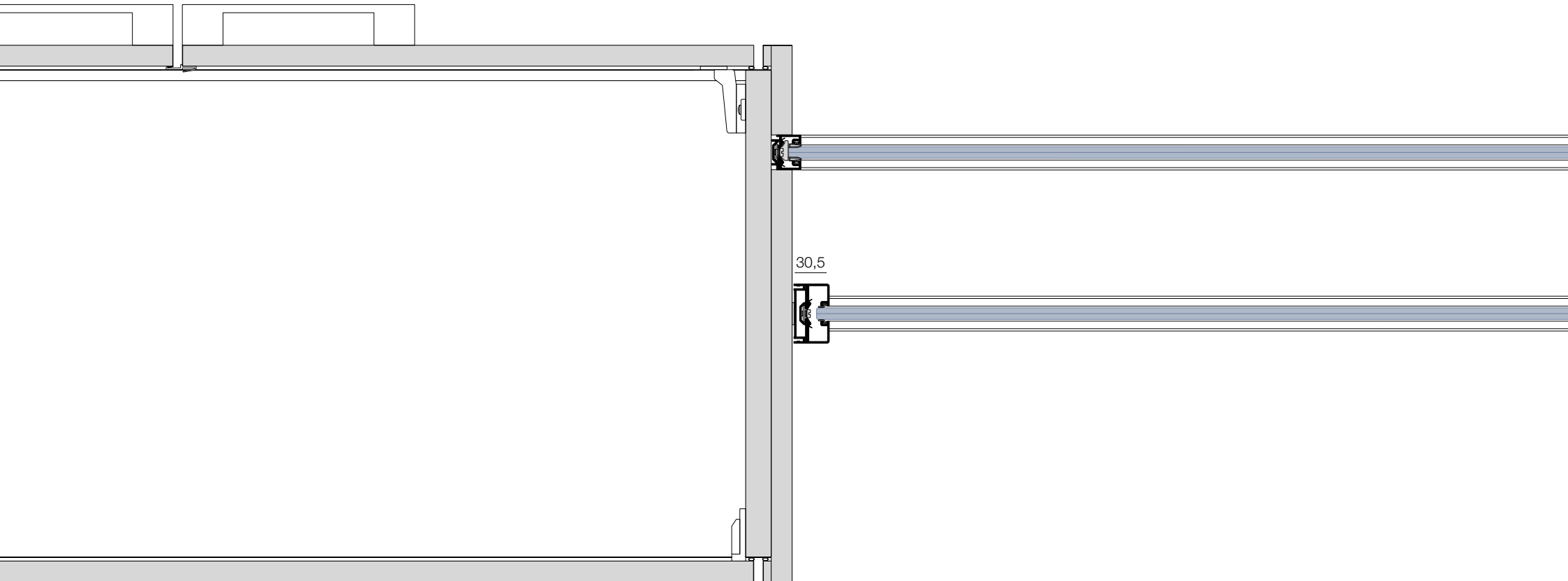

Partenze da contenitore



variabile

**Connessione
in alluminio**

**Connessione
in policarbonato**

**Connessione
con biadesivo tecnico**

**Connessione
a tre vie
in alluminio**

**Connessione
a tre vie
in policarbonato**

**Connessione
a tre vie
con biadesivo tecnico**

Angoli



Angolo a 90°
in policarbonato/alluminio



Angolo a 90°
con biadesivo tecnico



Angolo 2 vie

Angolo variabile

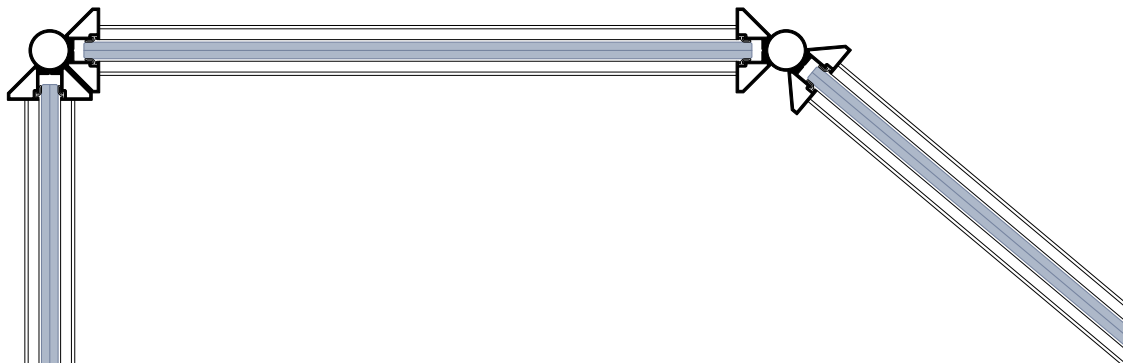

Angolo 3 vie

Angolo 4 vie

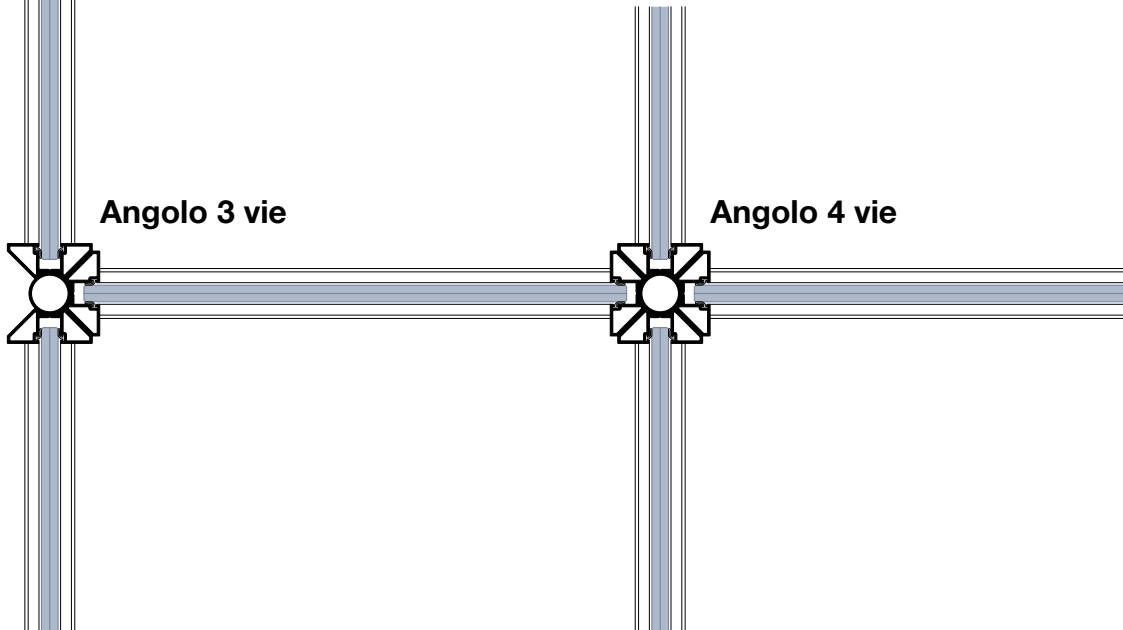

Cablaggio e modulo tecnico della porta a battente



Modulo tecnico

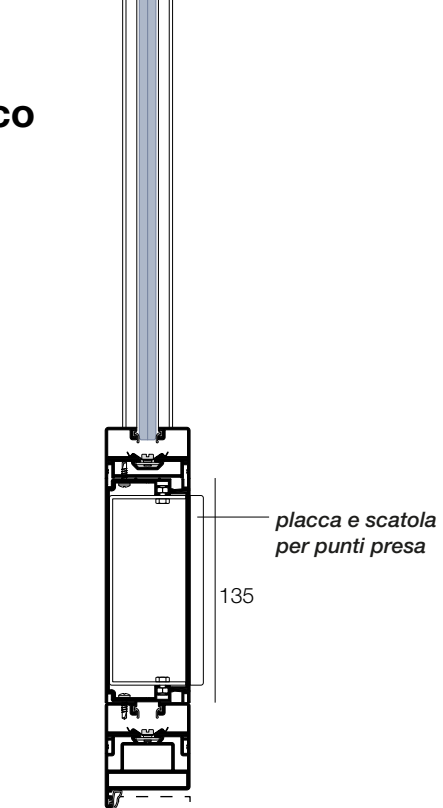

Soluzione di cablaggio

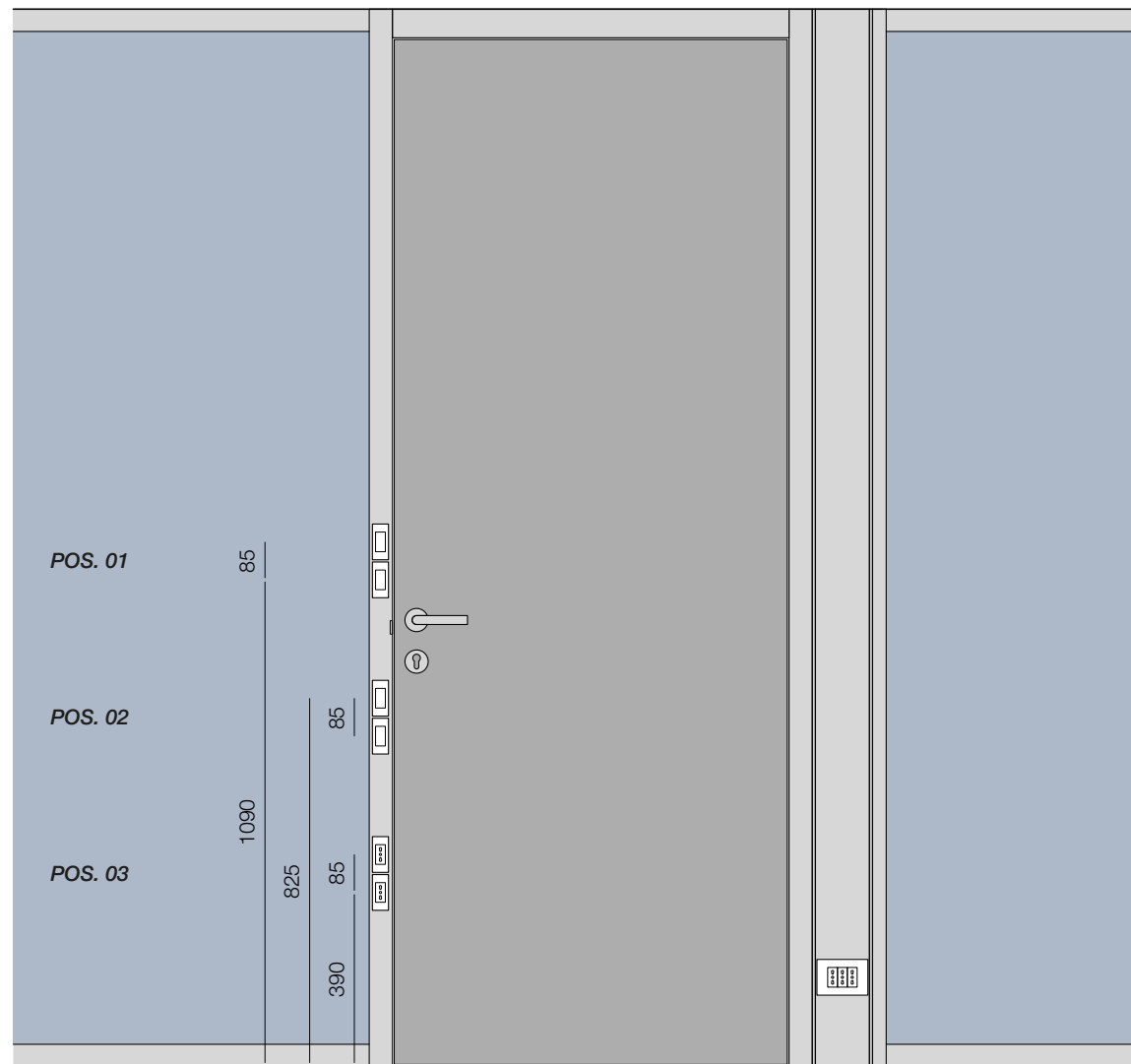
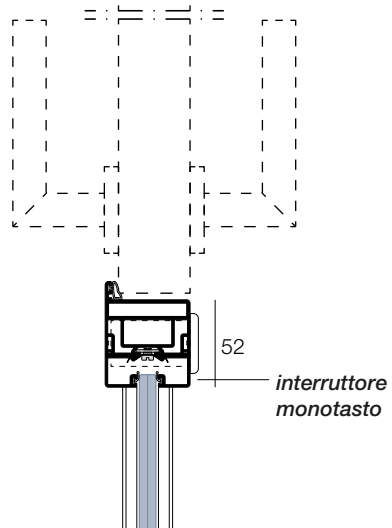

*posizioni possibili di interruttori e prese su telaio porta

Cablaggio e modulo tecnico della porta scorrevole



Modulo tecnico

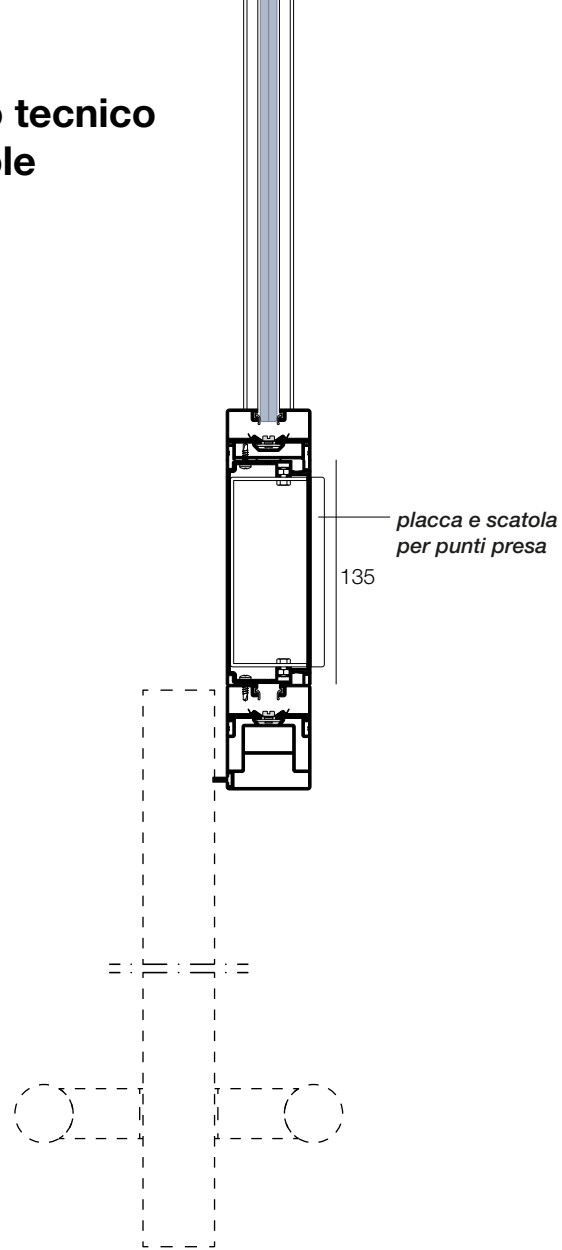

Soluzione di cablaggio

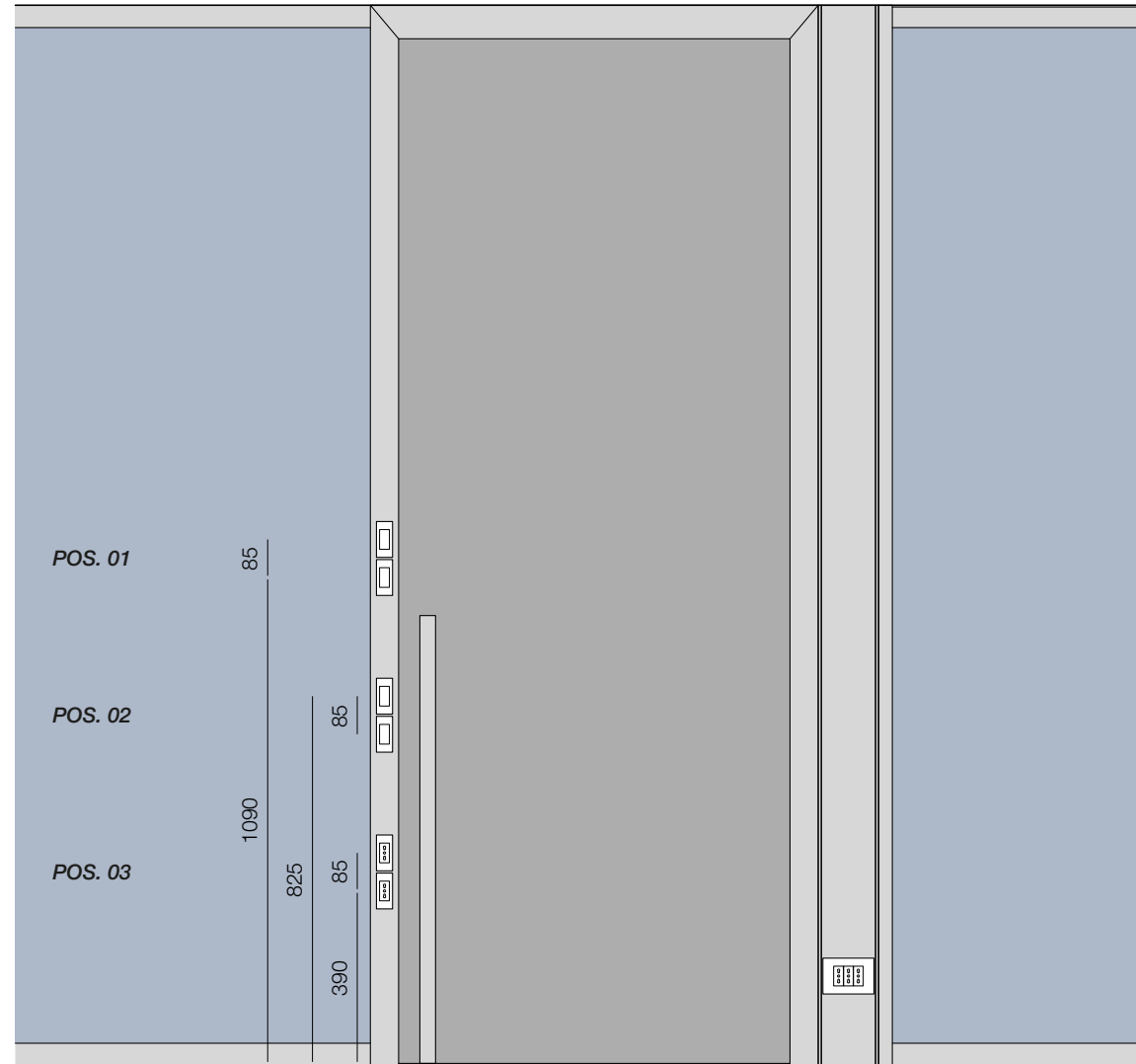
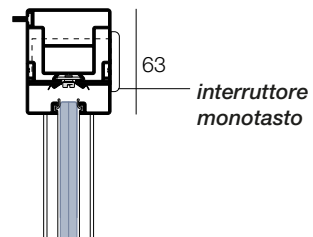

*posizioni possibili di interruttori e prese su telaio porta

Pannello cieco



Parete con pannello sospeso

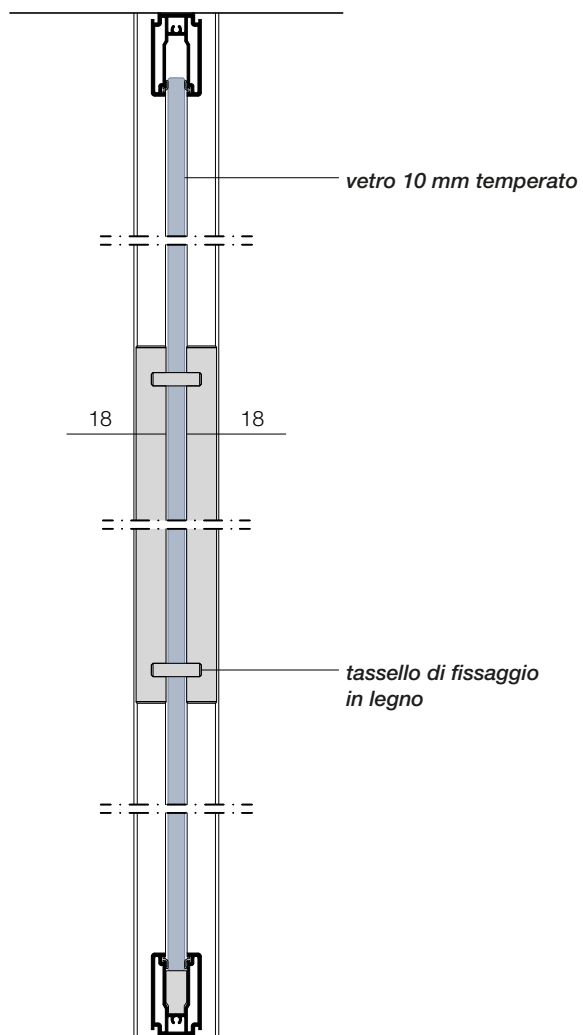

Parete con pannello intero

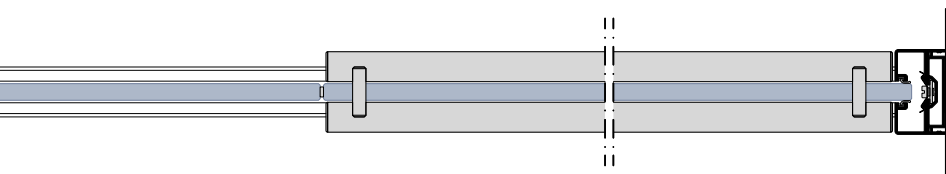
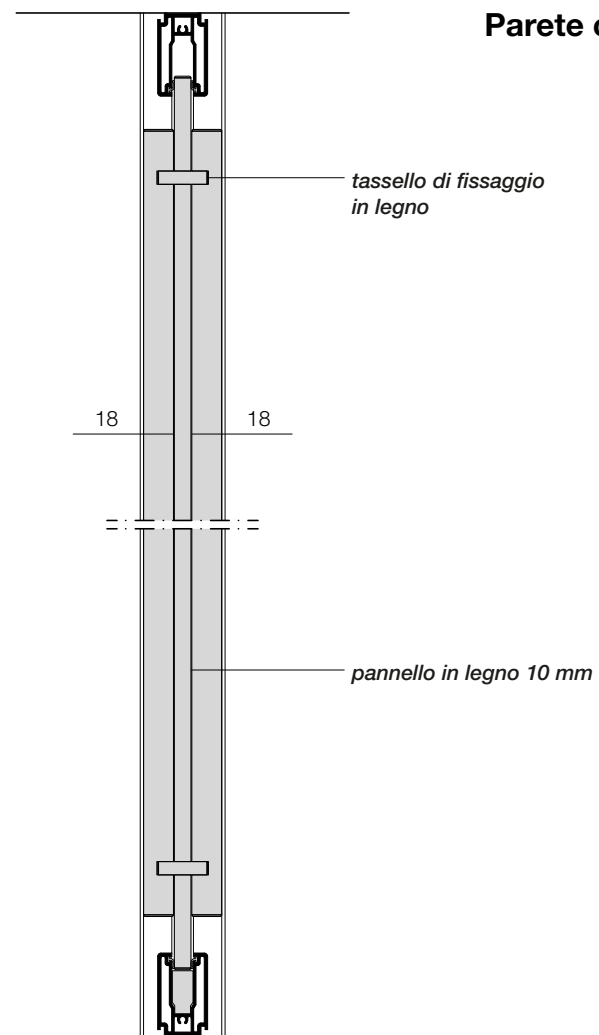

UNICA®

Porte e maniglie

TELAI PORTE BATTENTI



Telaio porta su **Unica Slim**

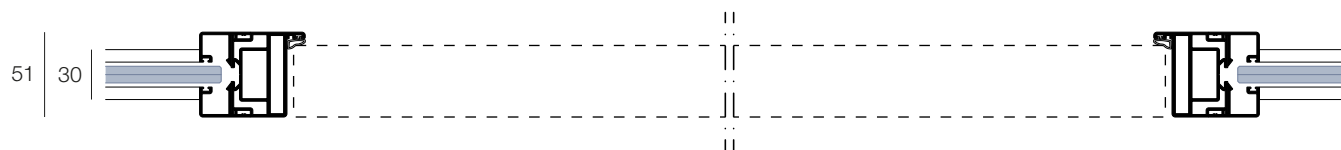

Telaio porta su **Unica U**

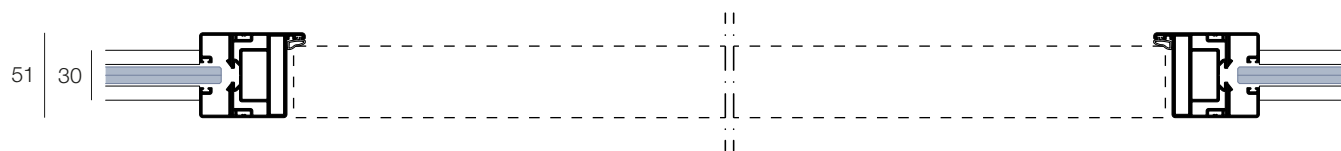

Telaio porta su **Unica SC**

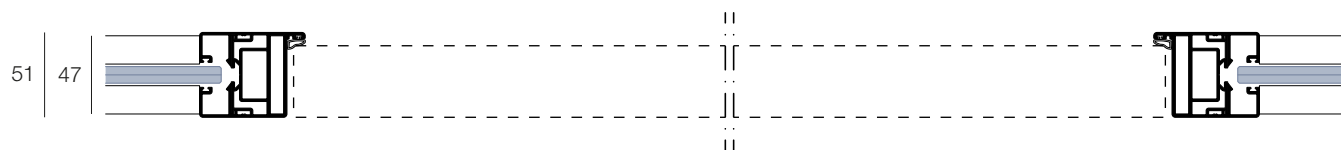

Telaio porta su **Unica R**

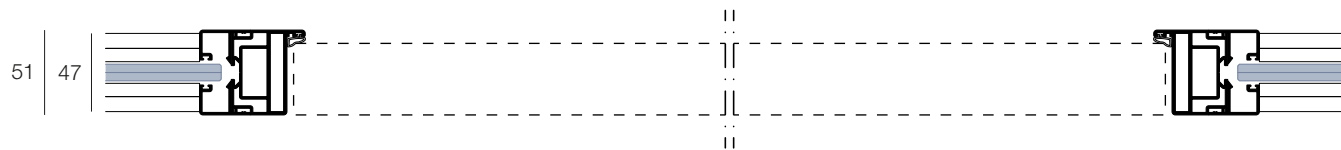

Telaio porta su **Unica D**

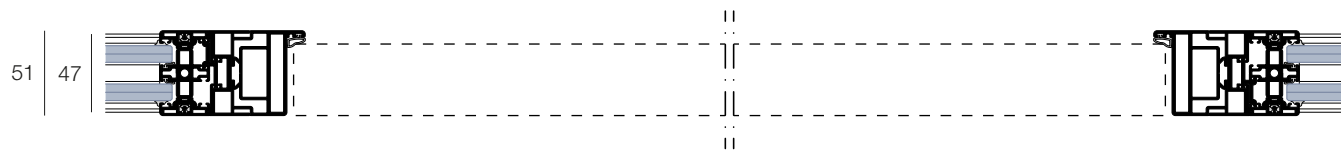

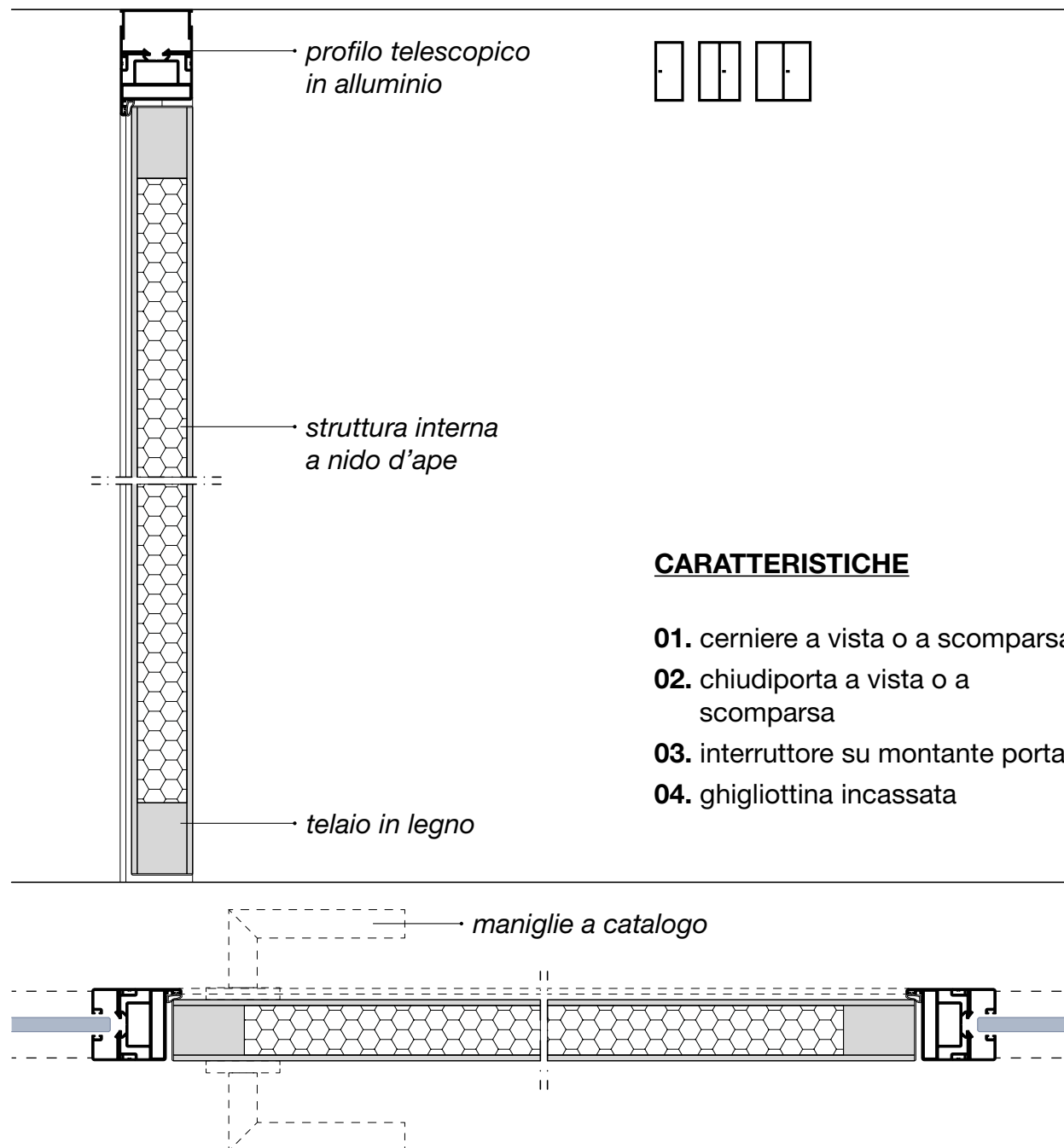

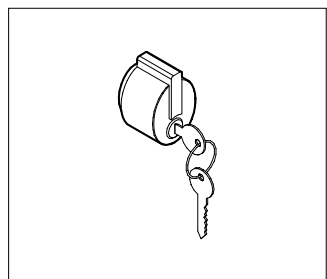

ML1

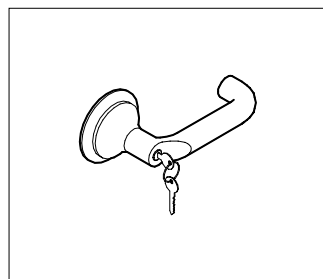

ML4

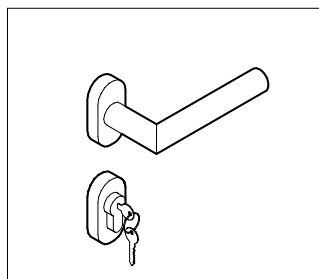

ML5

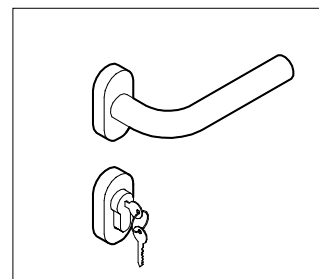

ML6

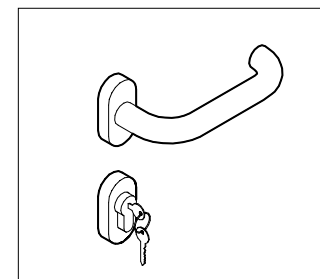

ML7

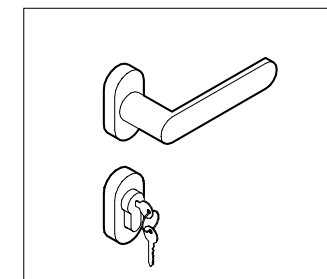

ML8

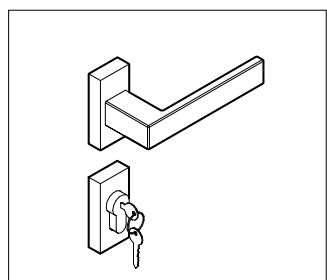

ML9

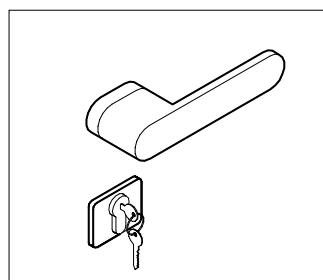

ML10

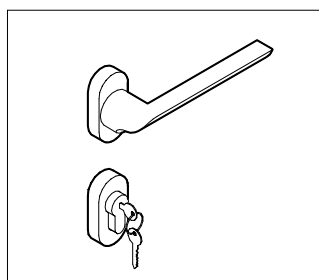

ML11

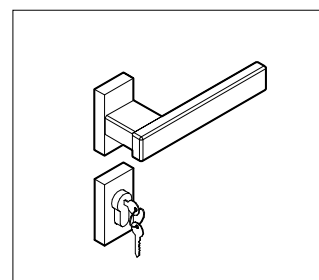

MLQ

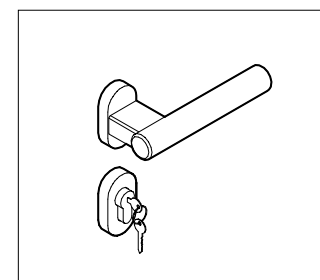

MLT

ANTA VETRO TEMPERATO_CERNIERE A VISTA sp. 10 mm

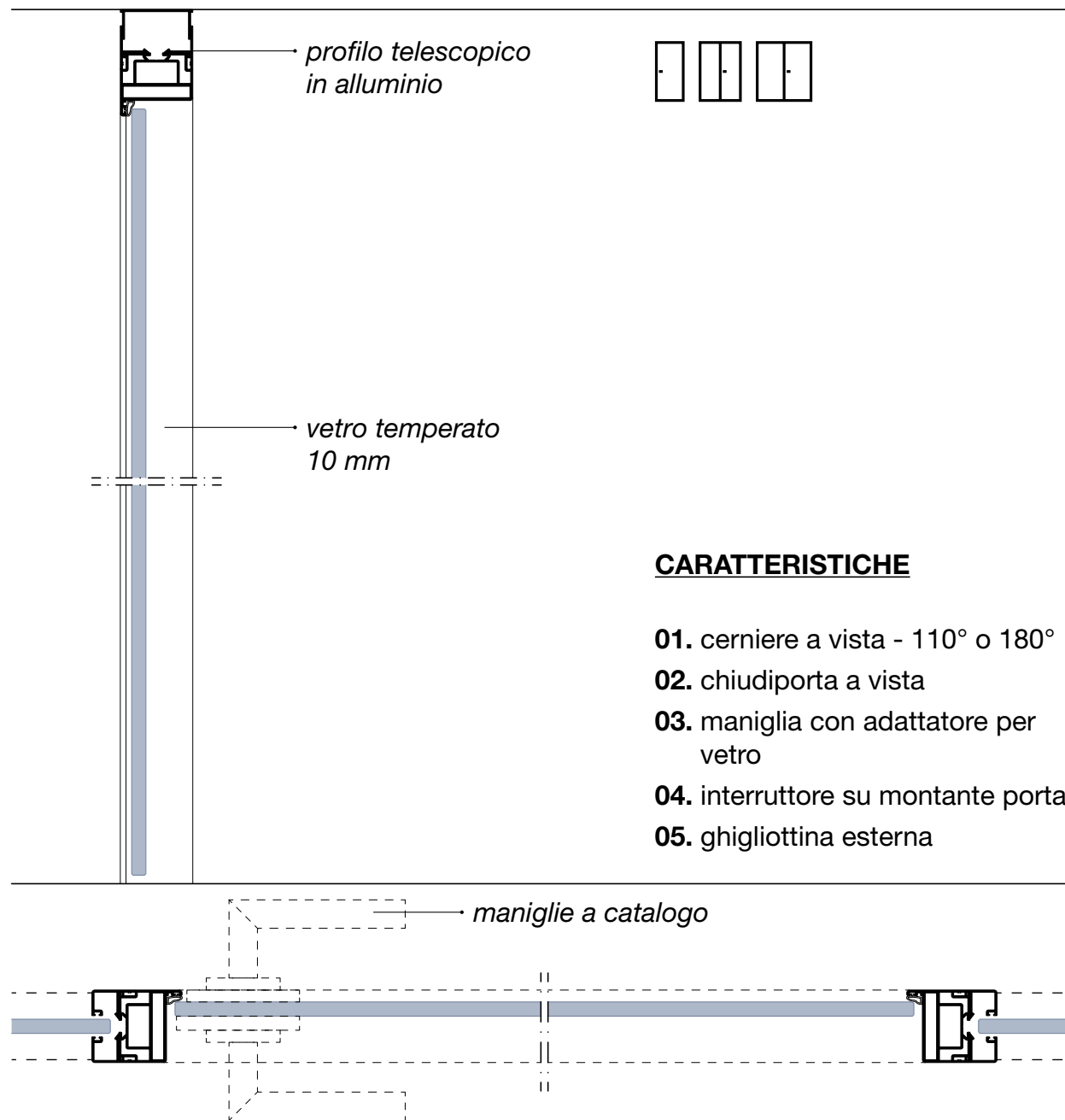

ANTA VETRO TEMPERATO_CERNIERE A VISTA sp. 10 mm

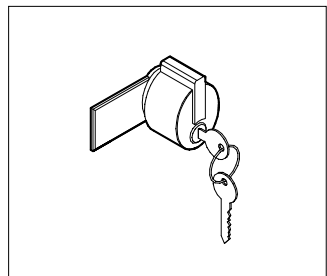

MC1

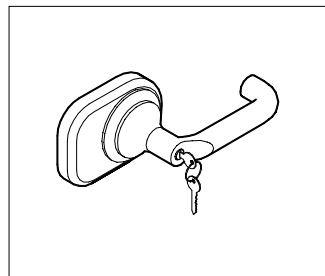

MC4

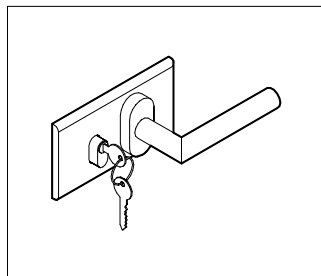

MC5

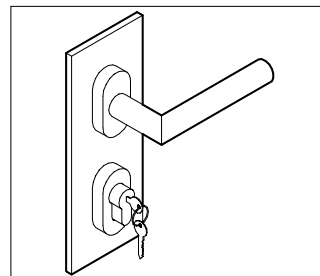

MC5V

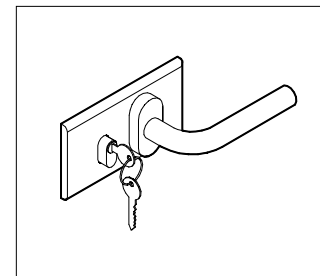

MC6

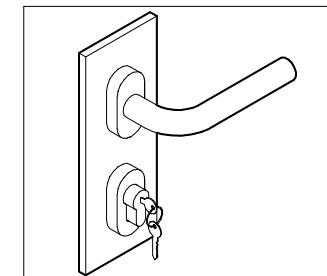

MC6V

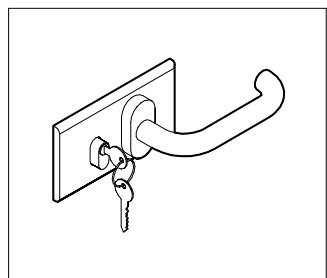

MC7

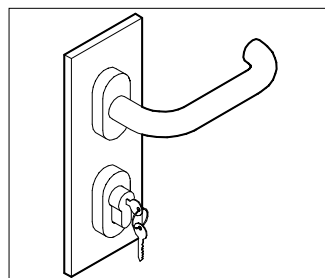

MC7V

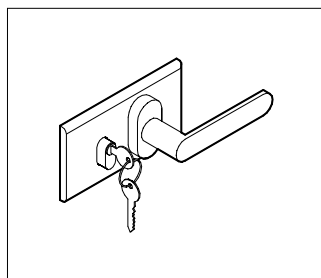

MC8

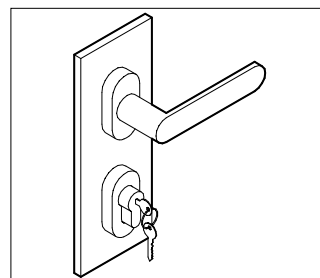

MC8V

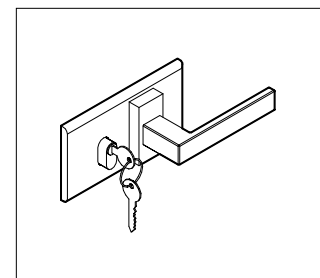

MC9

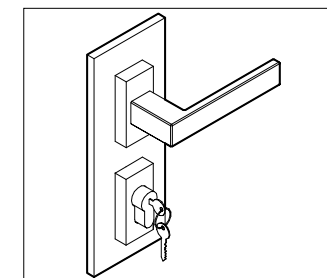

MC9V

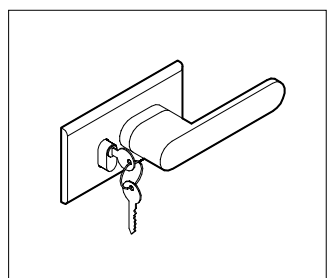

MC10

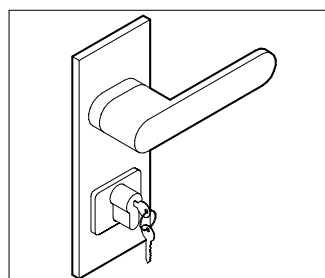

MC10V

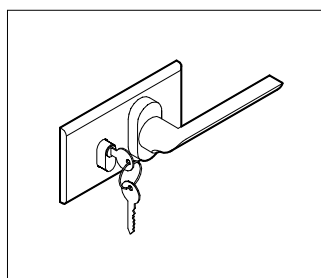

MC11

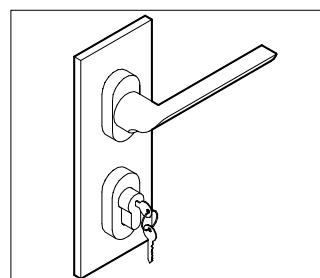

MC11V

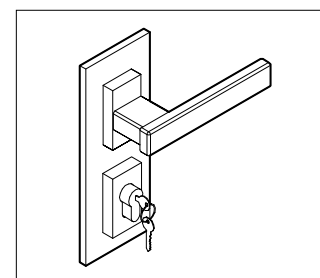

MCQ

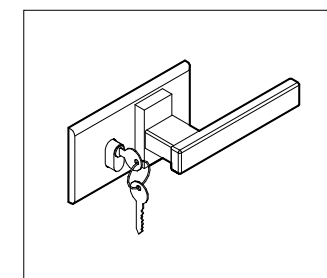

MCQO

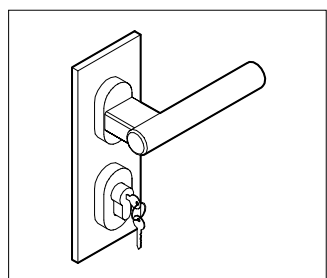

MCT

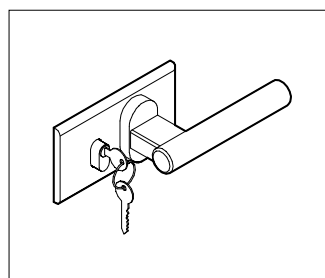

MCTO

ANTA VETRO TEMPERATO_CERNIERA CONTINUA sp. 10 mm

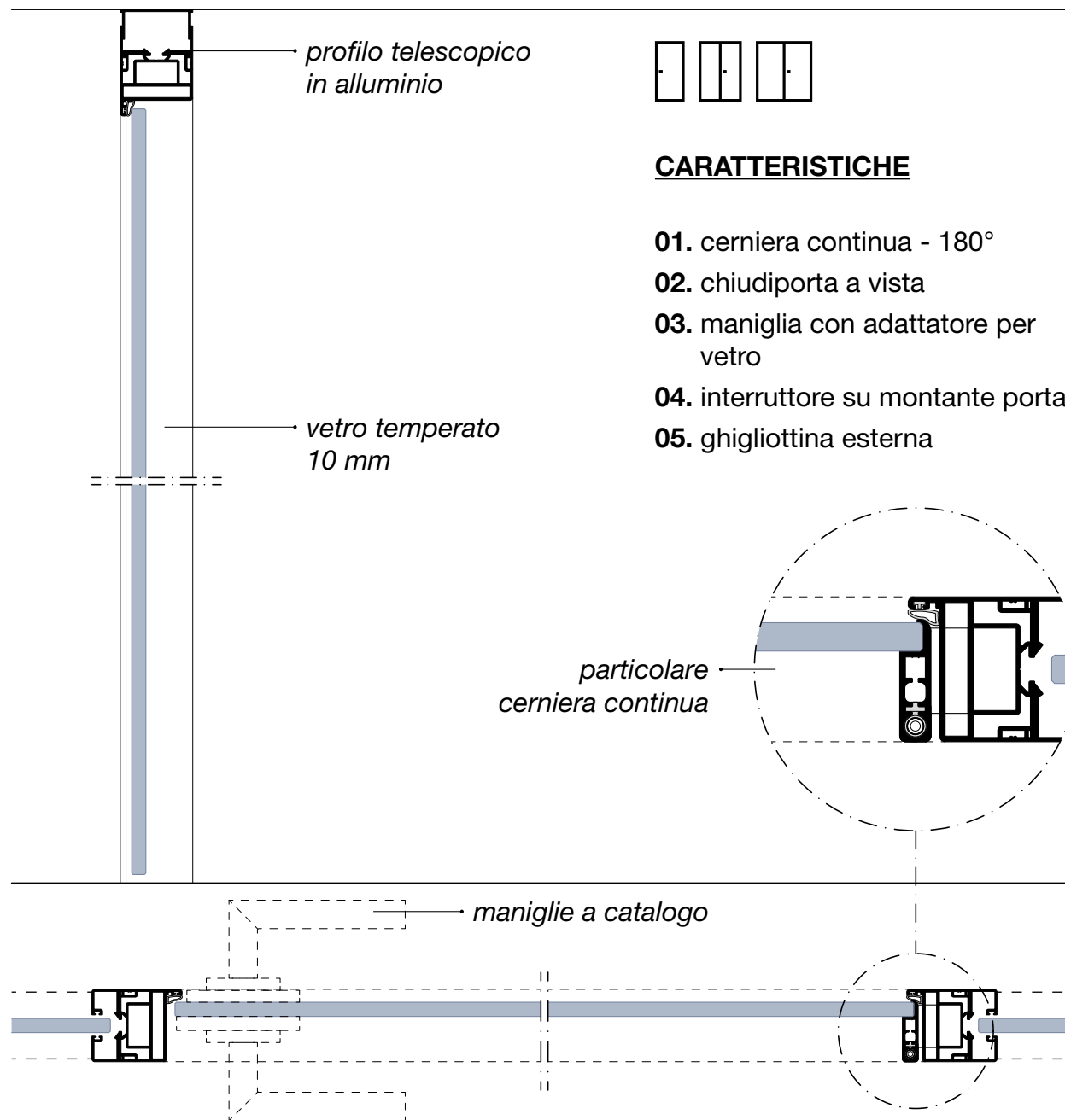

ANTA VETRO TEMPERATO_CERNIERA CONTINUA sp. 10 mm

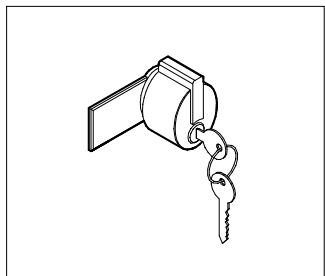

MC1

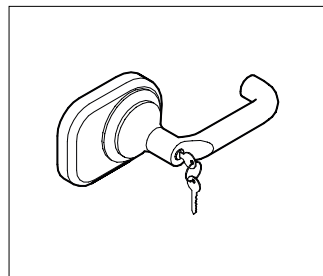

MC4

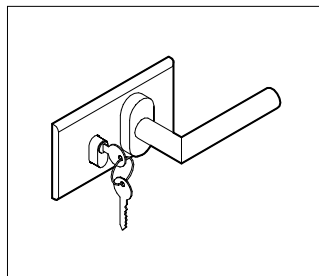

MC5

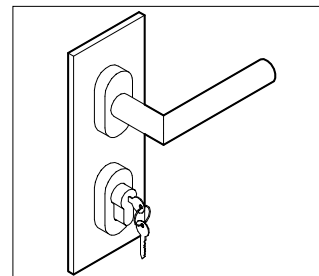

MC5V

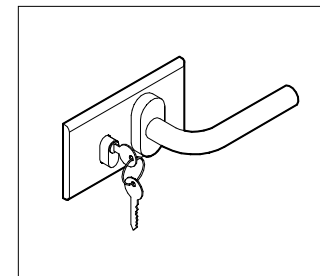

MC6

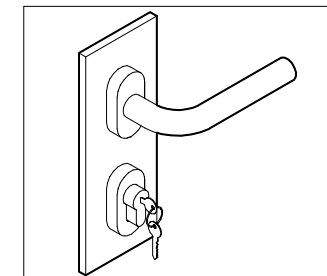

MC6V

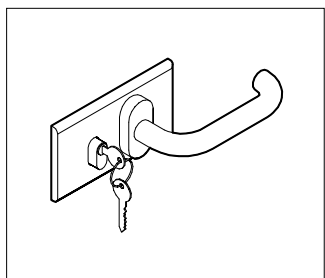

MC7

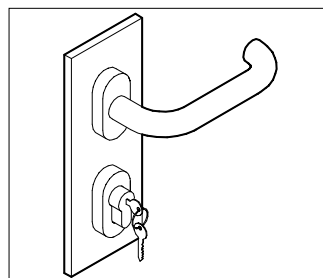

MC7V

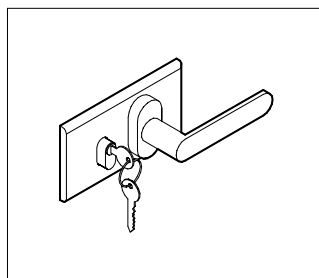

MC8

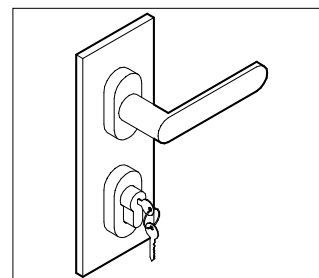

MC8V

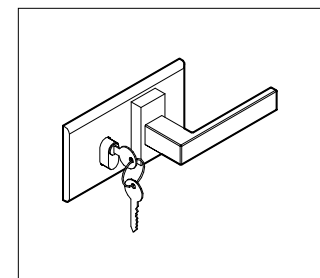

MC9

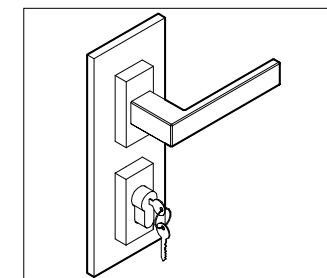

MC9V

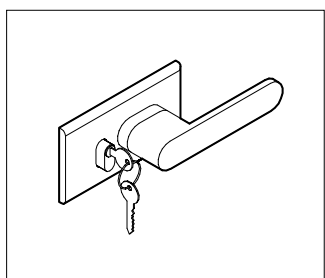

MC10

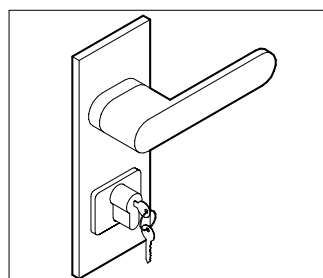

MC10V

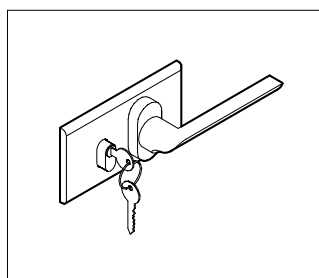

MC11

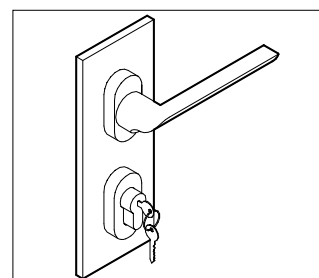

MC11V

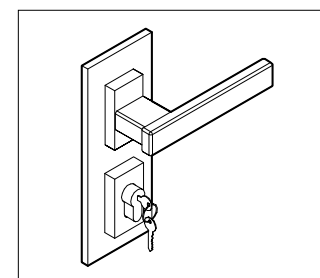

MCQ

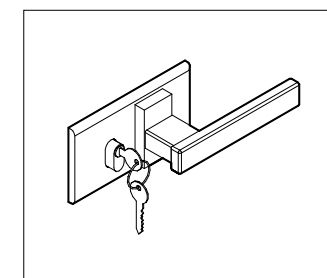

MCQO

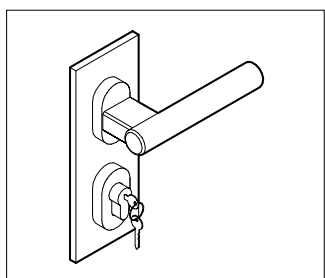

MCT

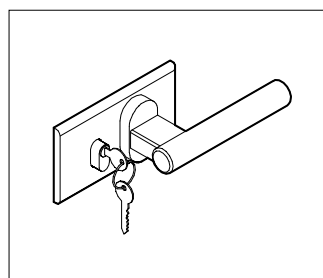

MCTO

ANTA INTELAIATA GRANDE CON PANNELLO sp. 43 mm

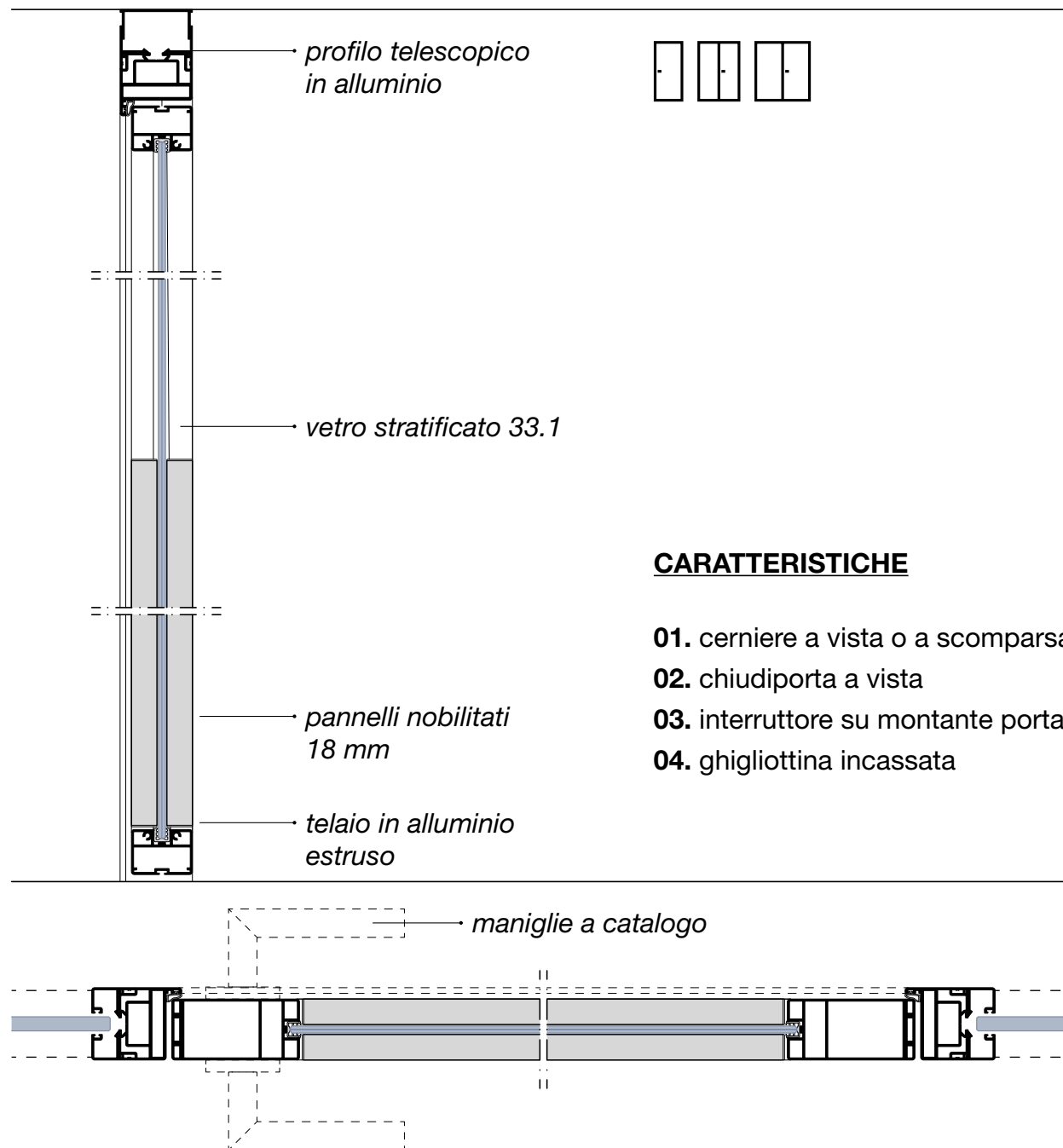

ANTA INTELAIATA GRANDE CON PANNELLO sp. 43 mm

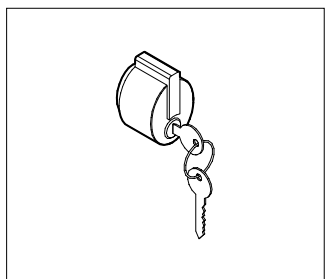

ML1

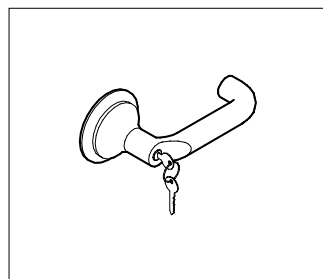

ML4

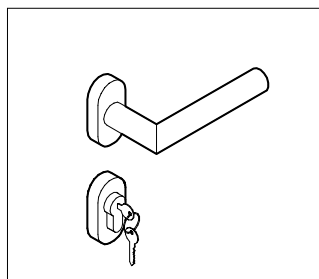

ML5

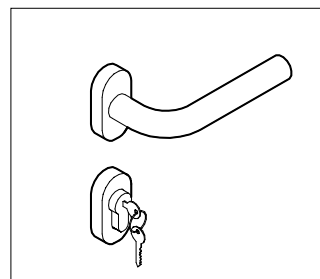

ML6

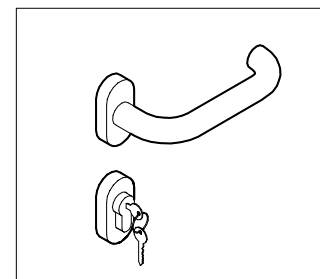

ML7

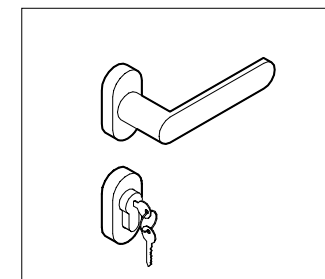

ML8

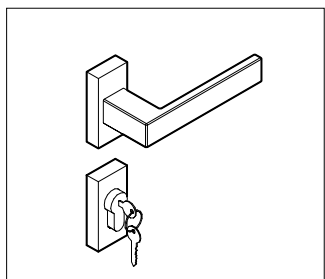

ML9

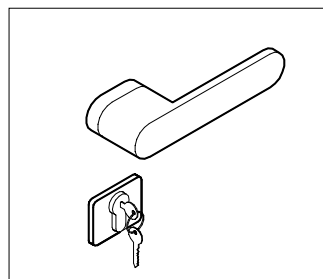

ML10

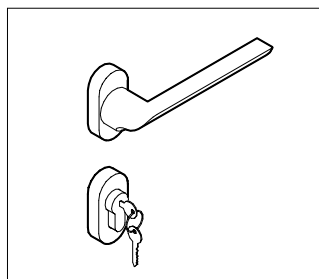

ML11

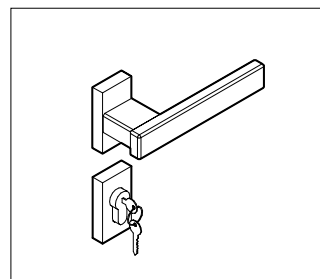

MLQ

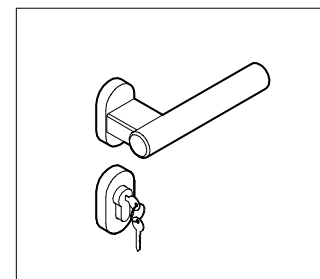

MLT

ANTA INTELAIATA GRANDE sp. 43 mm

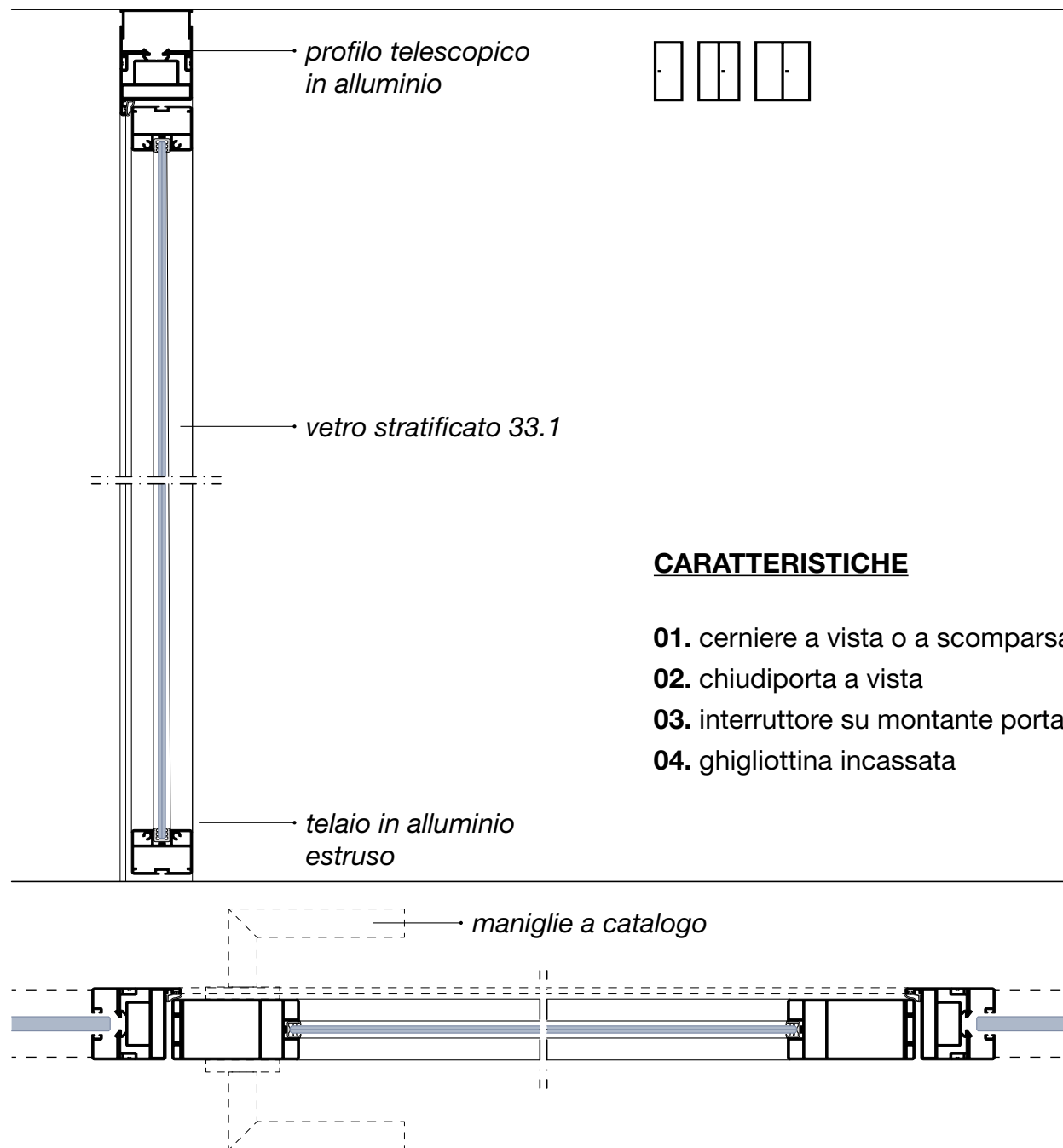

ANTA INTELAIATA GRANDE sp. 43 mm

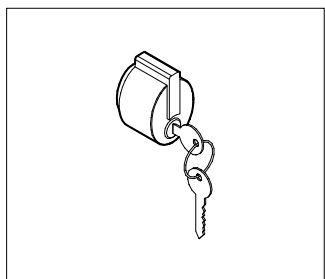

ML1

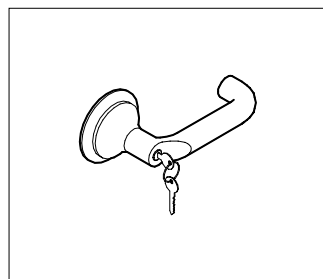

ML4

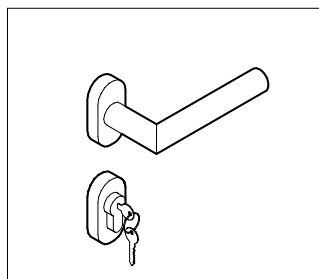

ML5

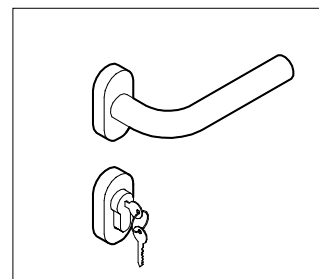

ML6

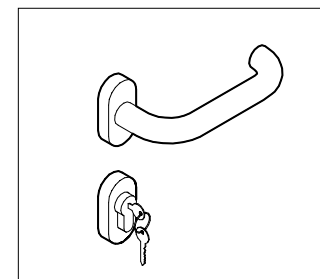

ML7

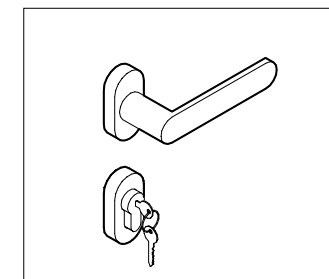

ML8

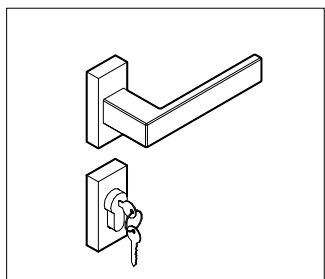

ML9

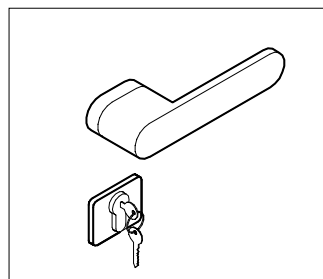

ML10

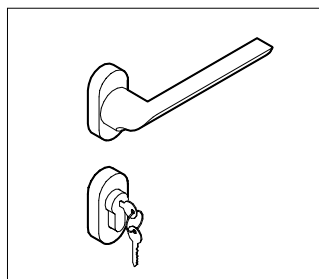

ML11

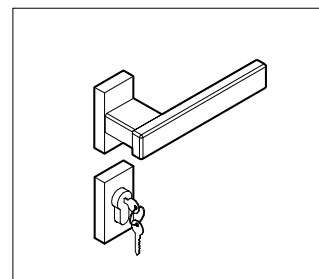

MLQ

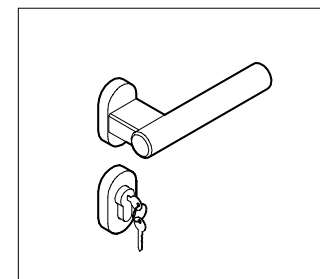

MLT

ANTA INTELAIATA MEDIA sp. 43 mm

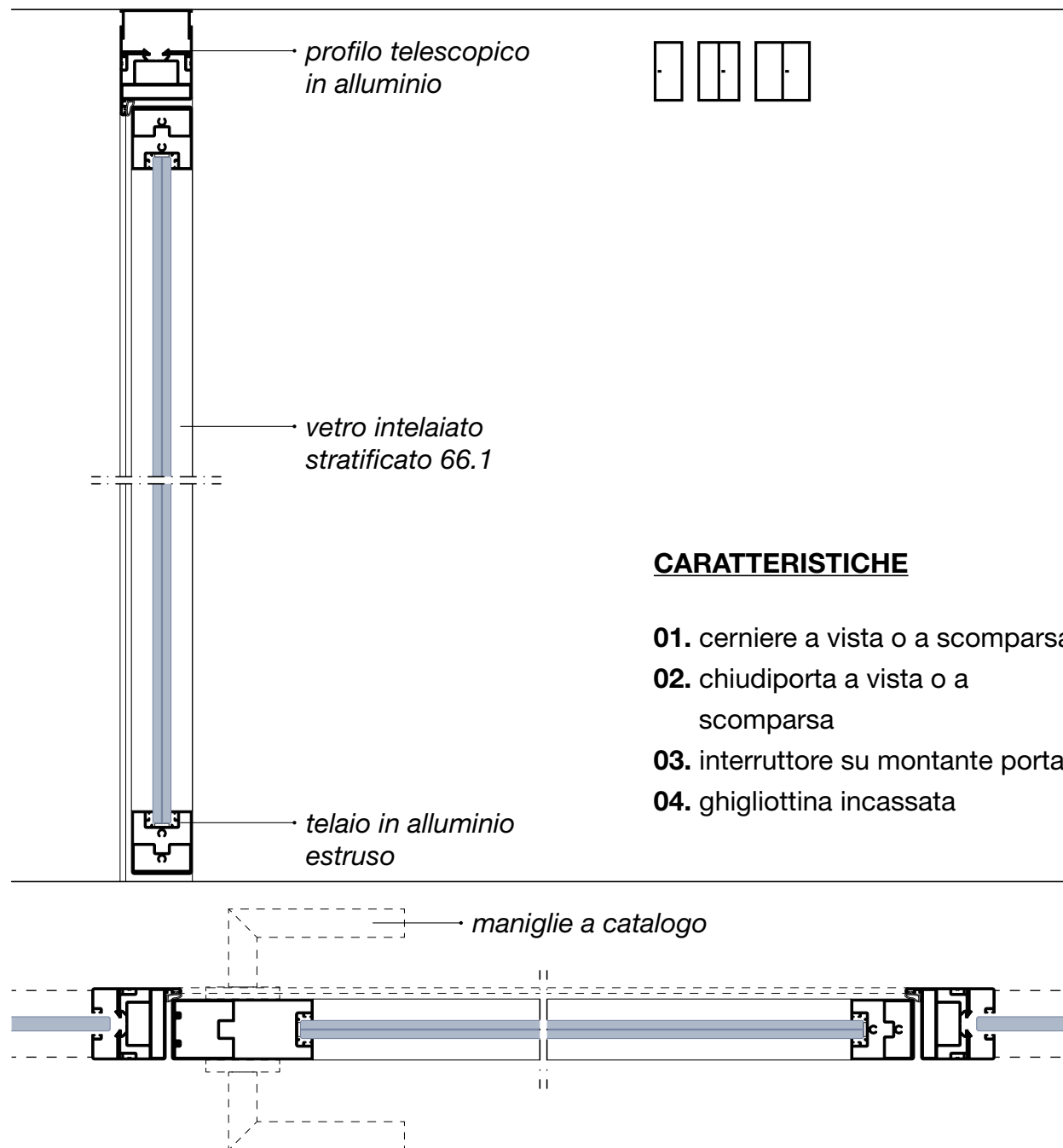

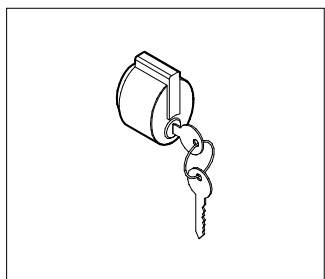

ML1

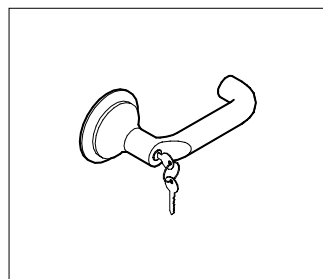

ML4

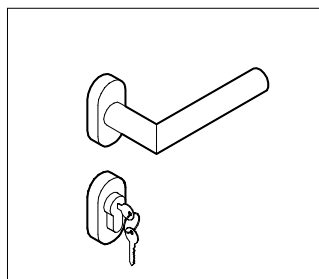

ML5

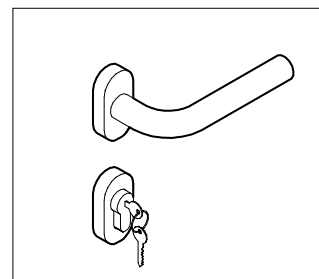

ML6

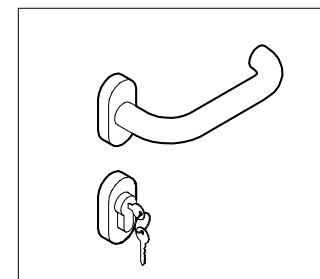

ML7

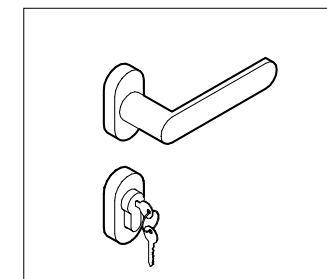

ML8

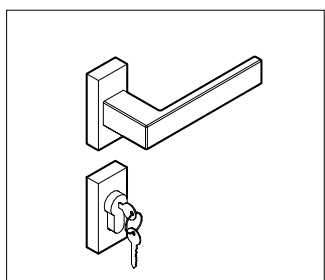

ML9

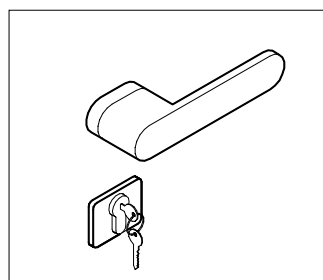

ML10

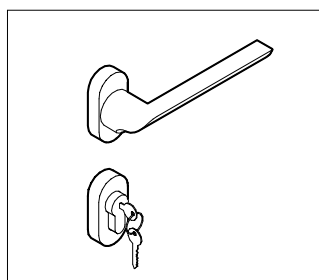

ML11

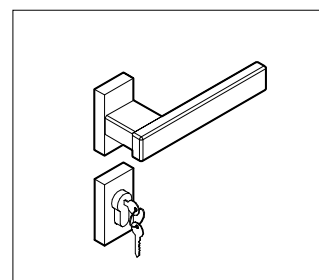

MLQ

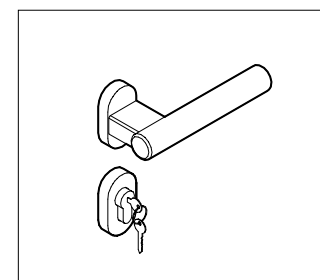

MLT

ANTA INTELAIATA SOTTILE sp. 43 mm

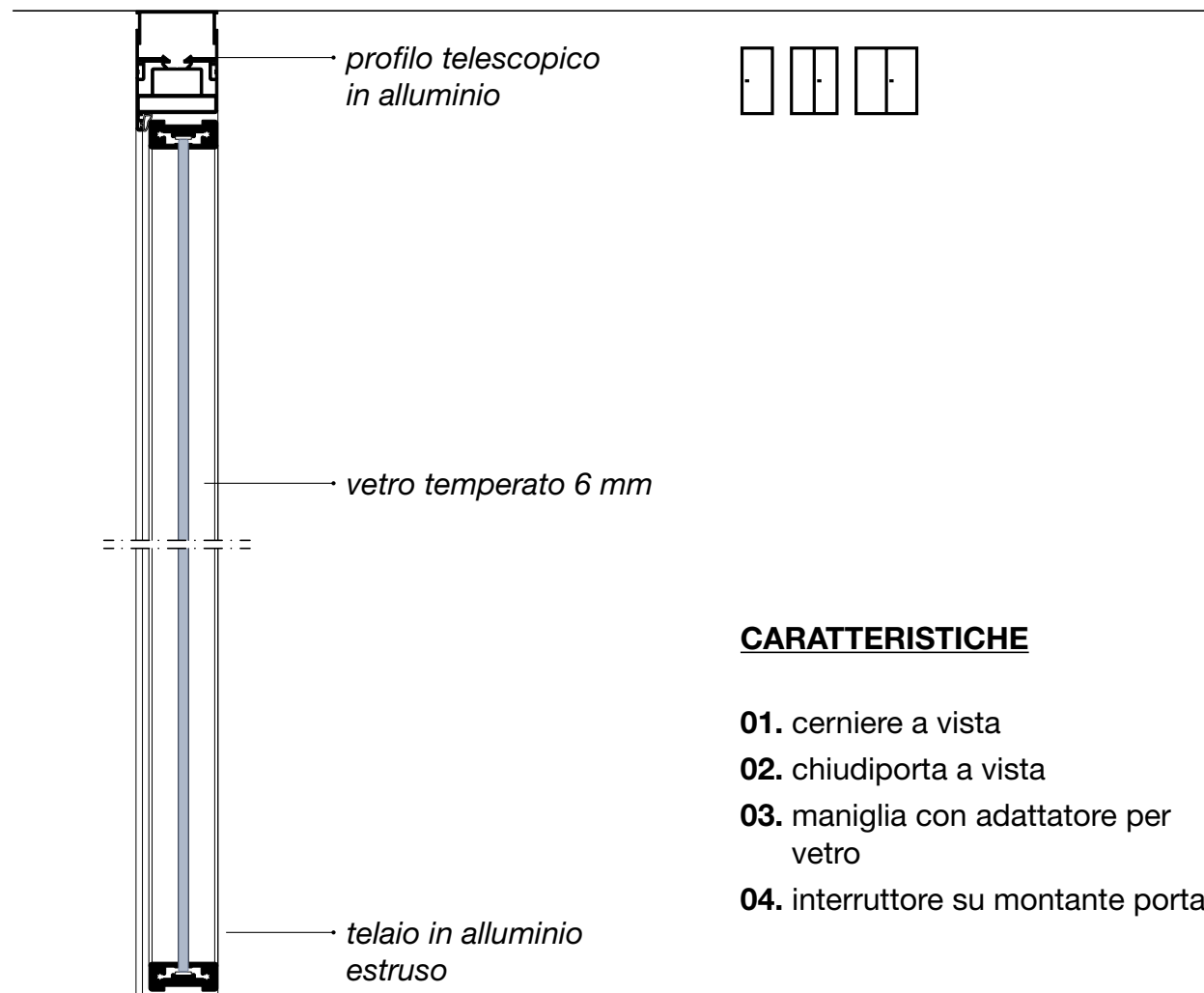

CARATTERISTICHE

- 01.** cerniere a vista
- 02.** chiudiporta a vista
- 03.** maniglia con adattatore per vetro
- 04.** interruttore su montante porta

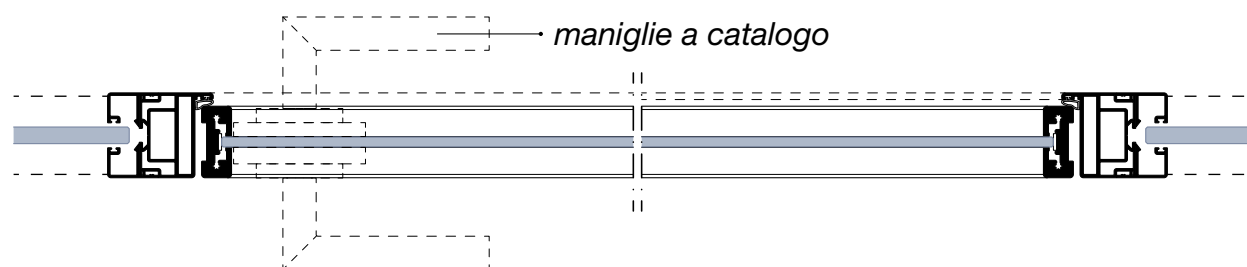

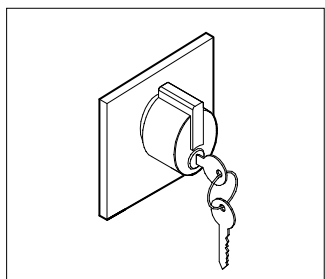

ML1

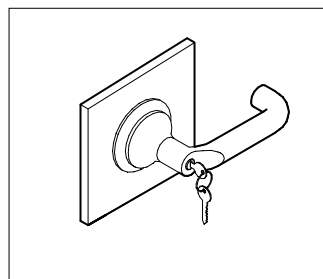

ML4

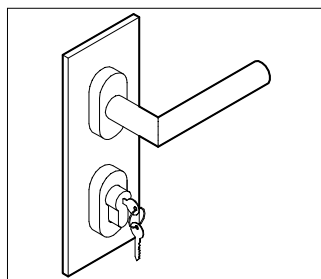

ML5

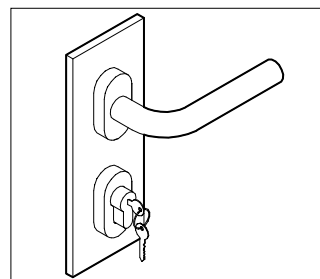

ML6

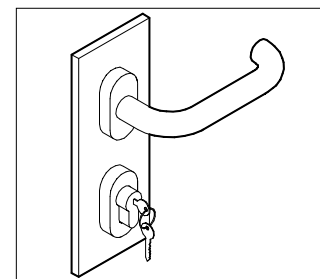

ML7

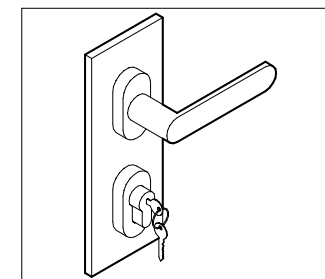

ML8

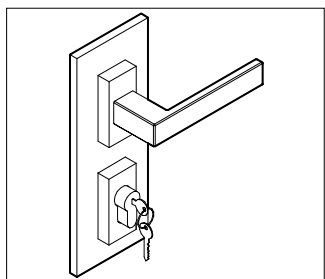

ML9

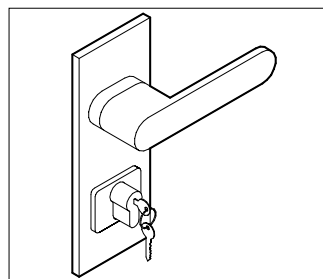

ML10

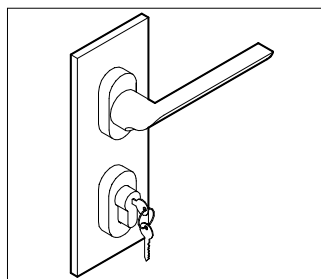

ML11

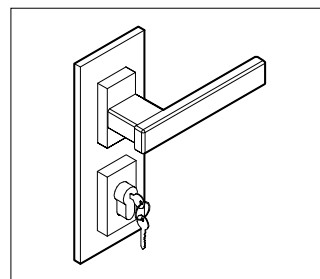

MLQ

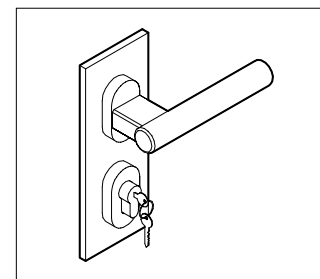

MLT

ANTA INTELAIATA VETRO DOPPIO sp. 51 mm

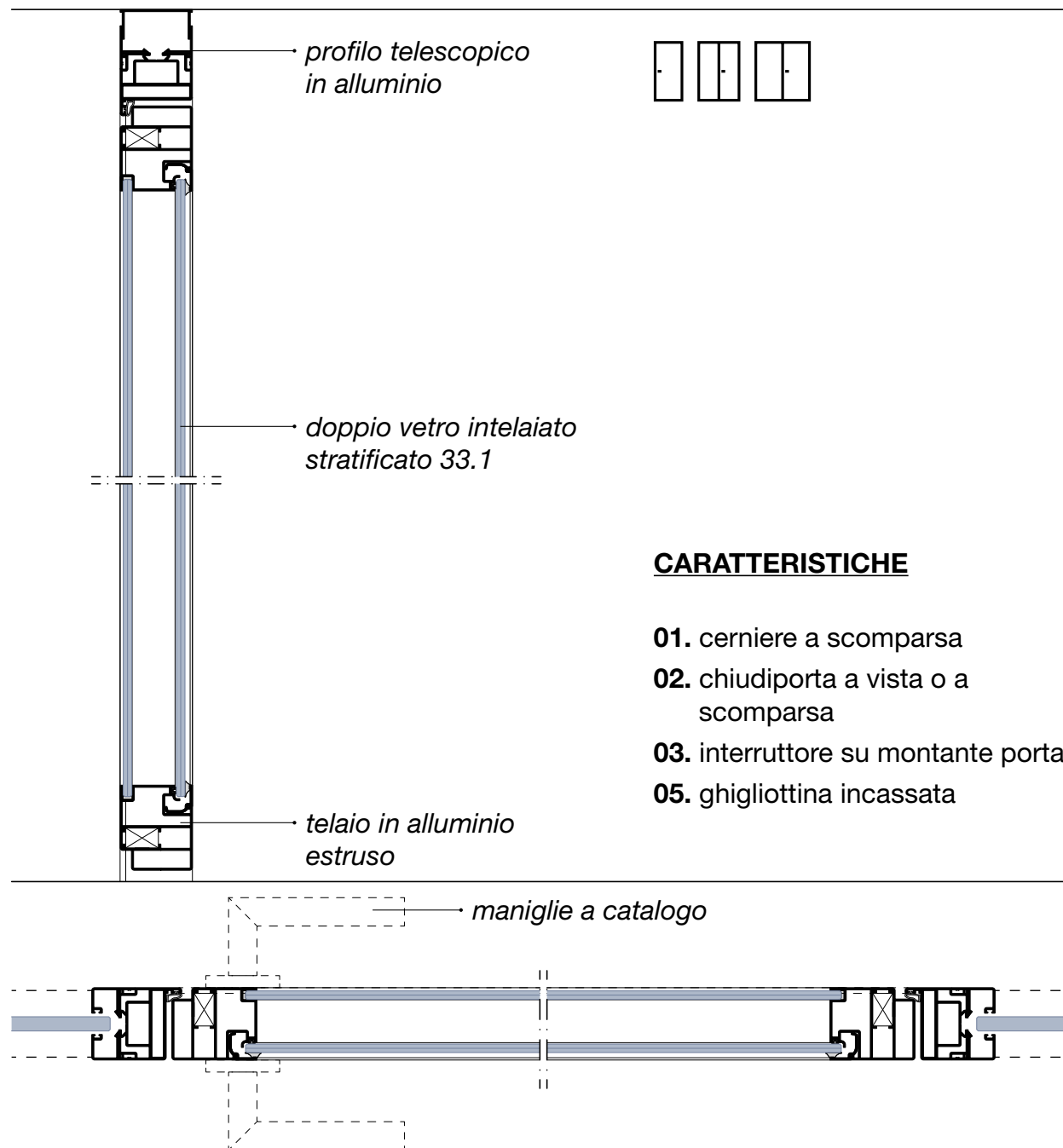

ANTA INTELAIATA VETRO DOPPIO sp. 51 mm

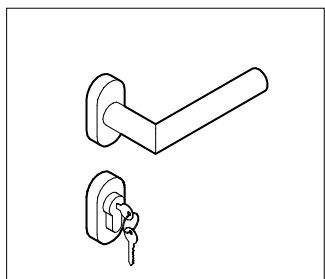

ML5

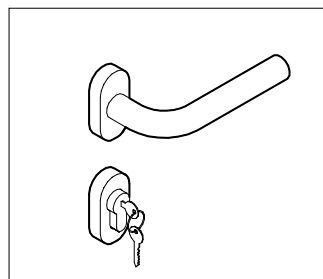

ML6

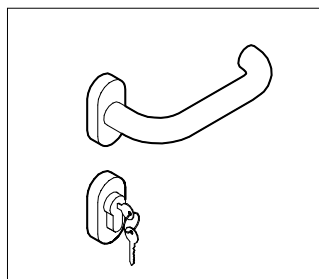

ML7

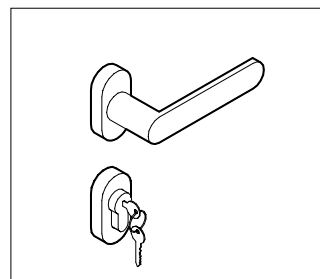

ML8

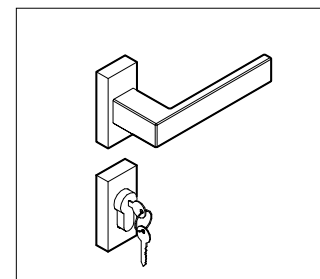

ML9

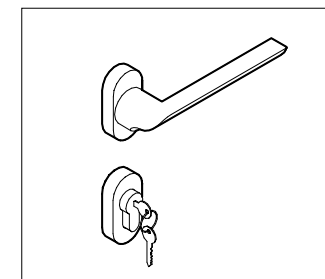

ML11

TELAI PORTE SCORREVOLI



Telaio porta su **Unica Slim**

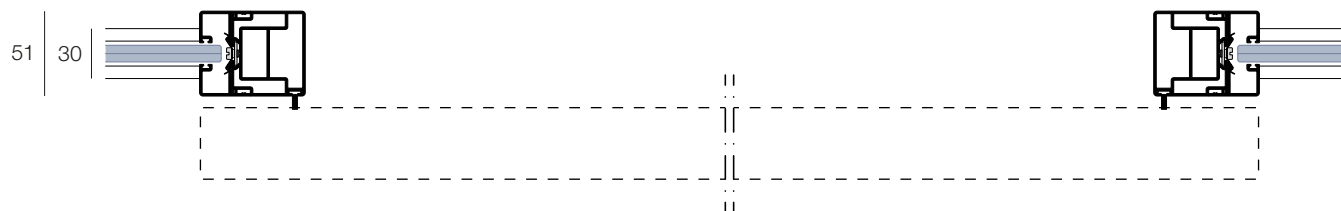

Telaio porta su **Unica U**

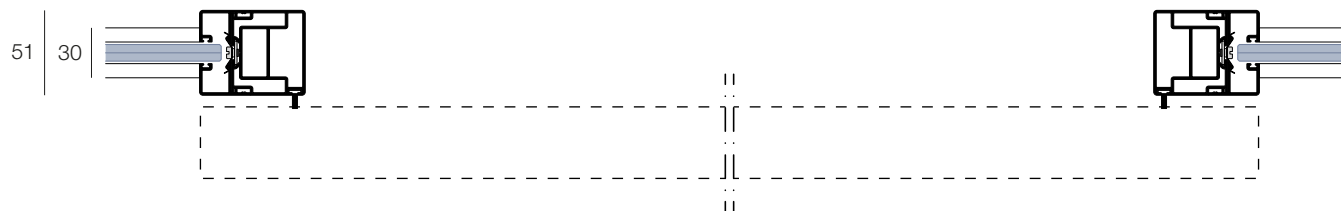

Telaio porta su **Unica SC1/SC2/SC3**

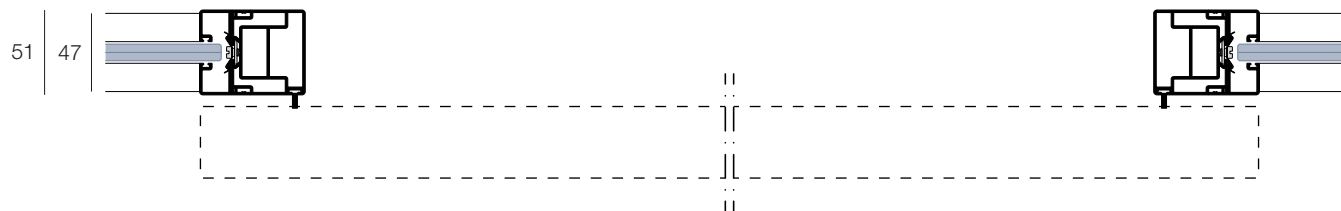

Telaio porta su **Unica R**

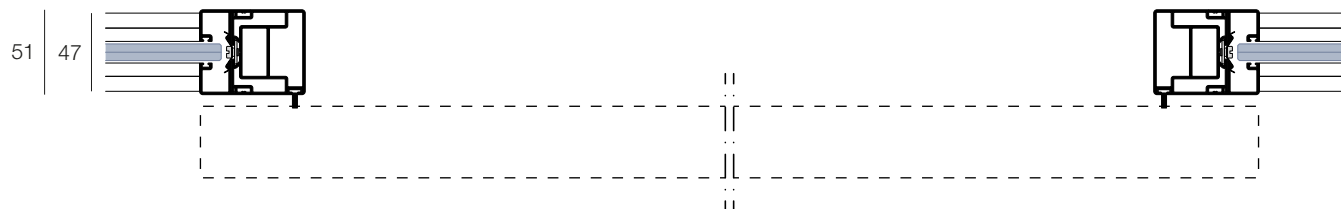

Telaio porta su **Unica D**

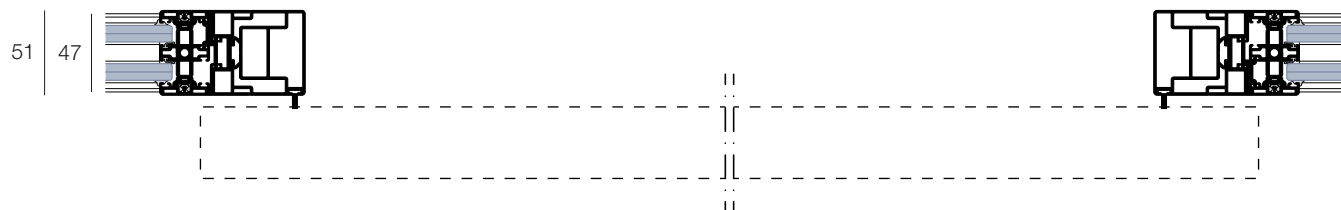

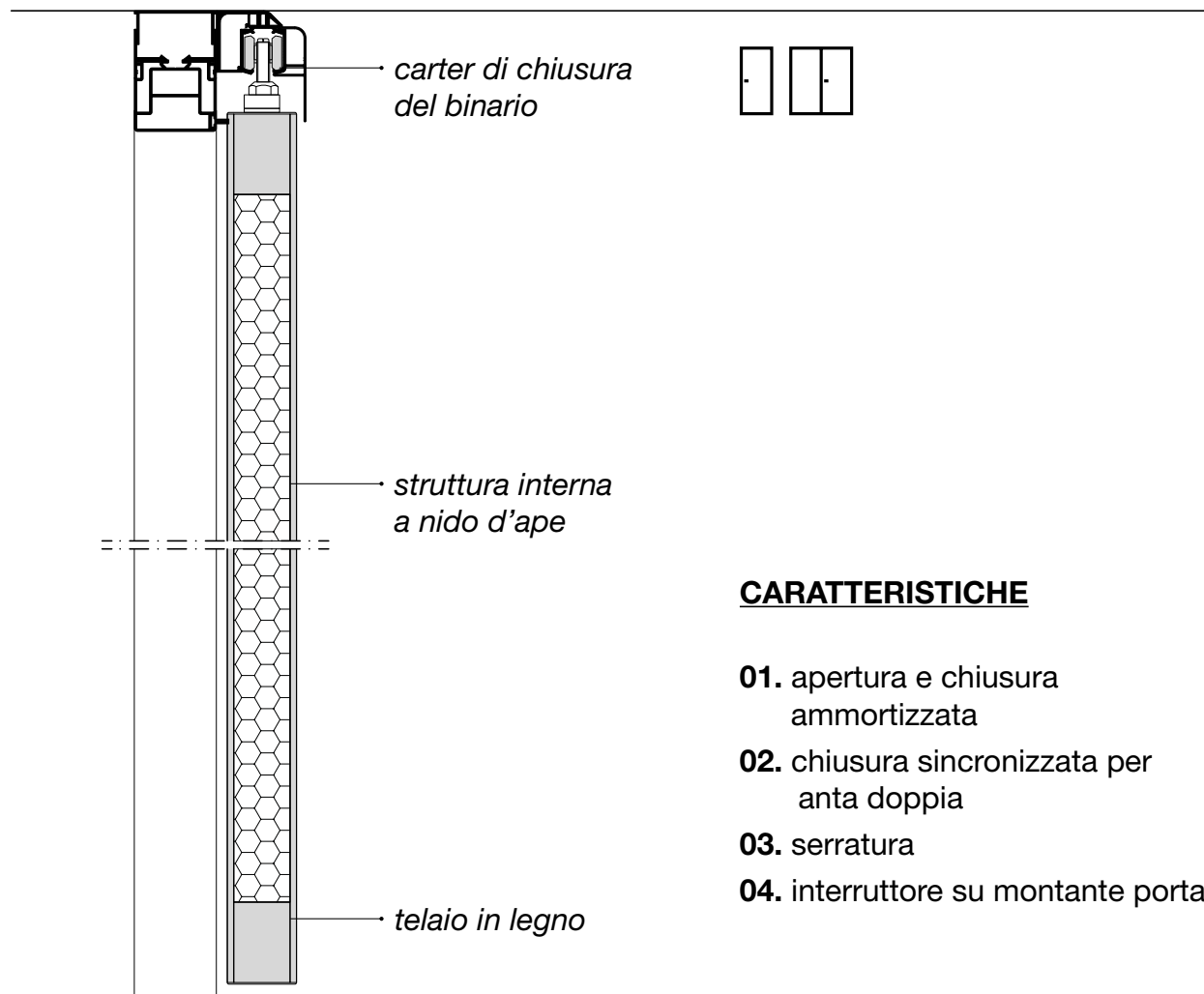

CARATTERISTICHE

- 01.** apertura e chiusura ammortizzata
- 02.** chiusura sincronizzata per anta doppia
- 03.** serratura
- 04.** interruttore su montante porta

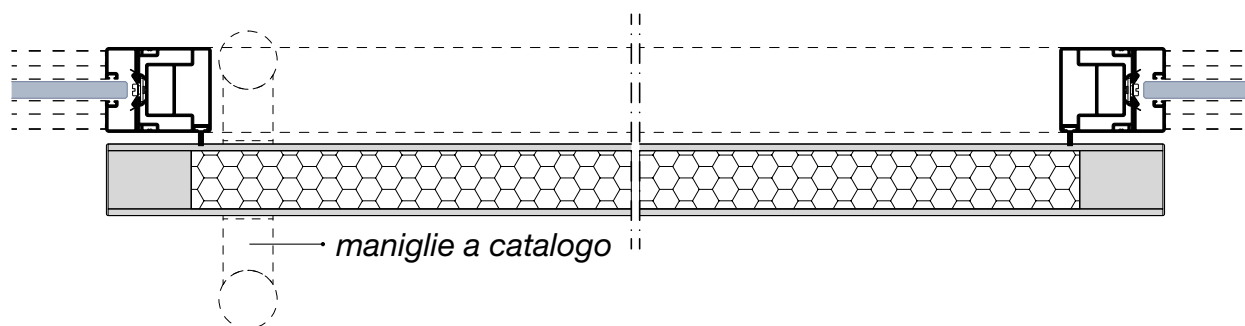

ANTA VETRO TEMPERATO sp. 10 mm

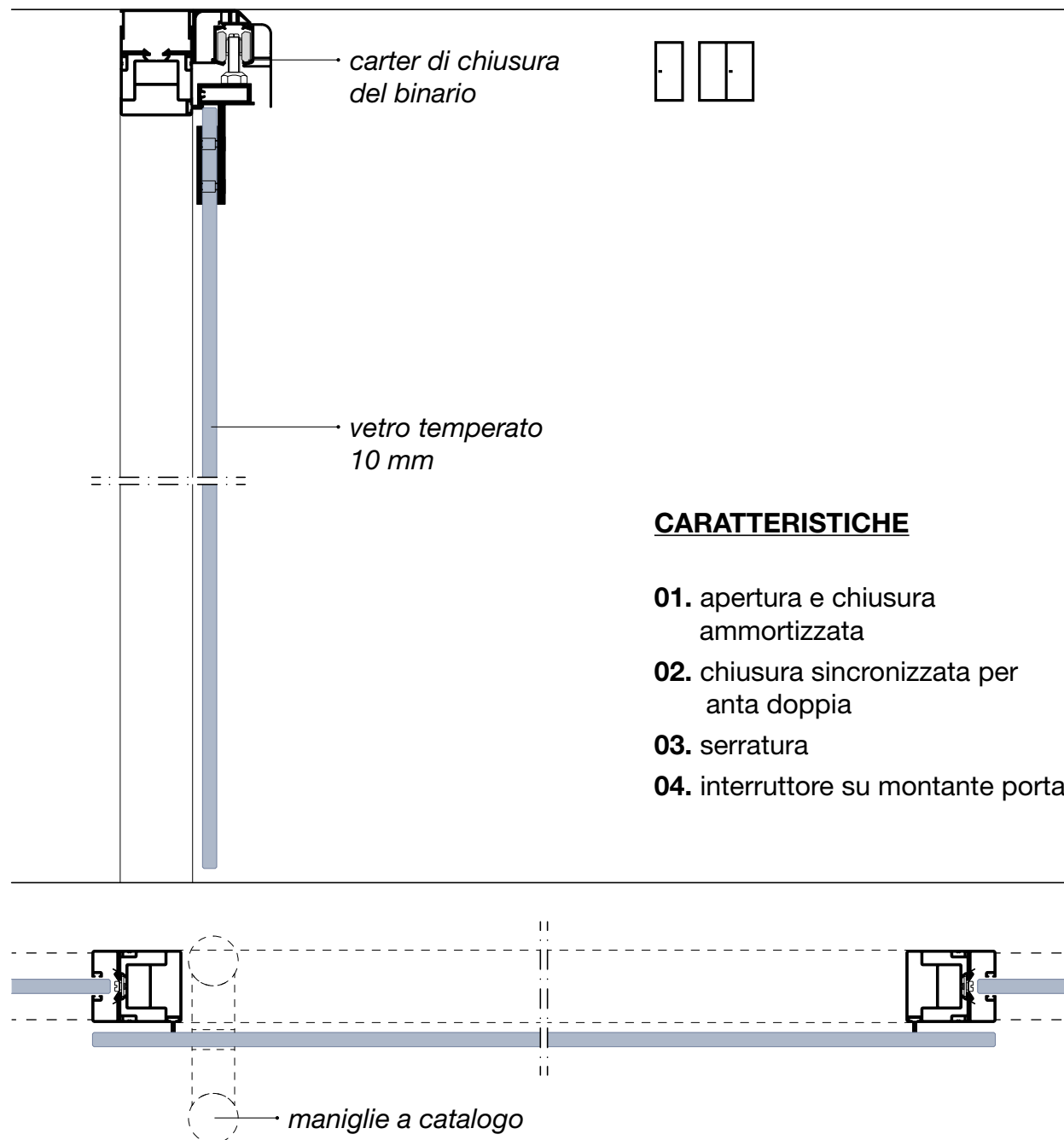

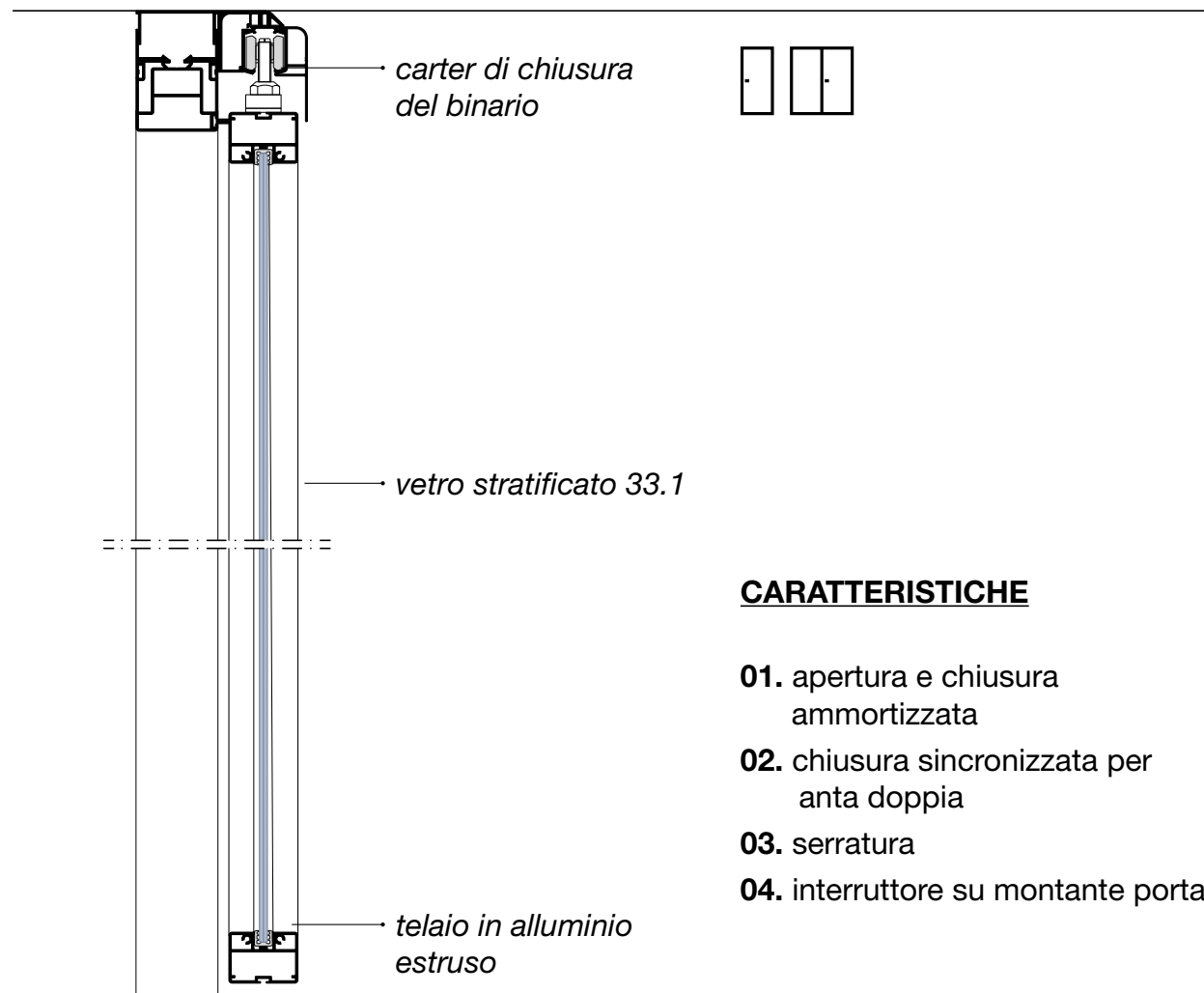

CARATTERISTICHE

- 01.** apertura e chiusura ammortizzata
- 02.** chiusura sincronizzata per anta doppia
- 03.** serratura
- 04.** interruttore su montante porta

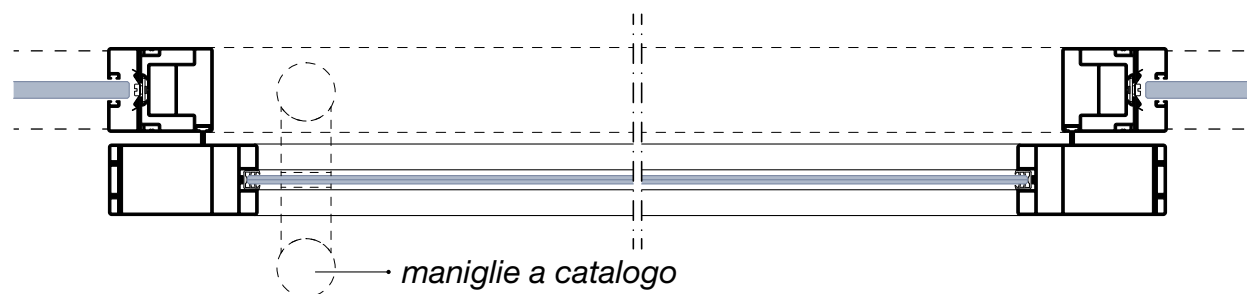

ANTA INTELAIATA MEDIA sp. 43 mm

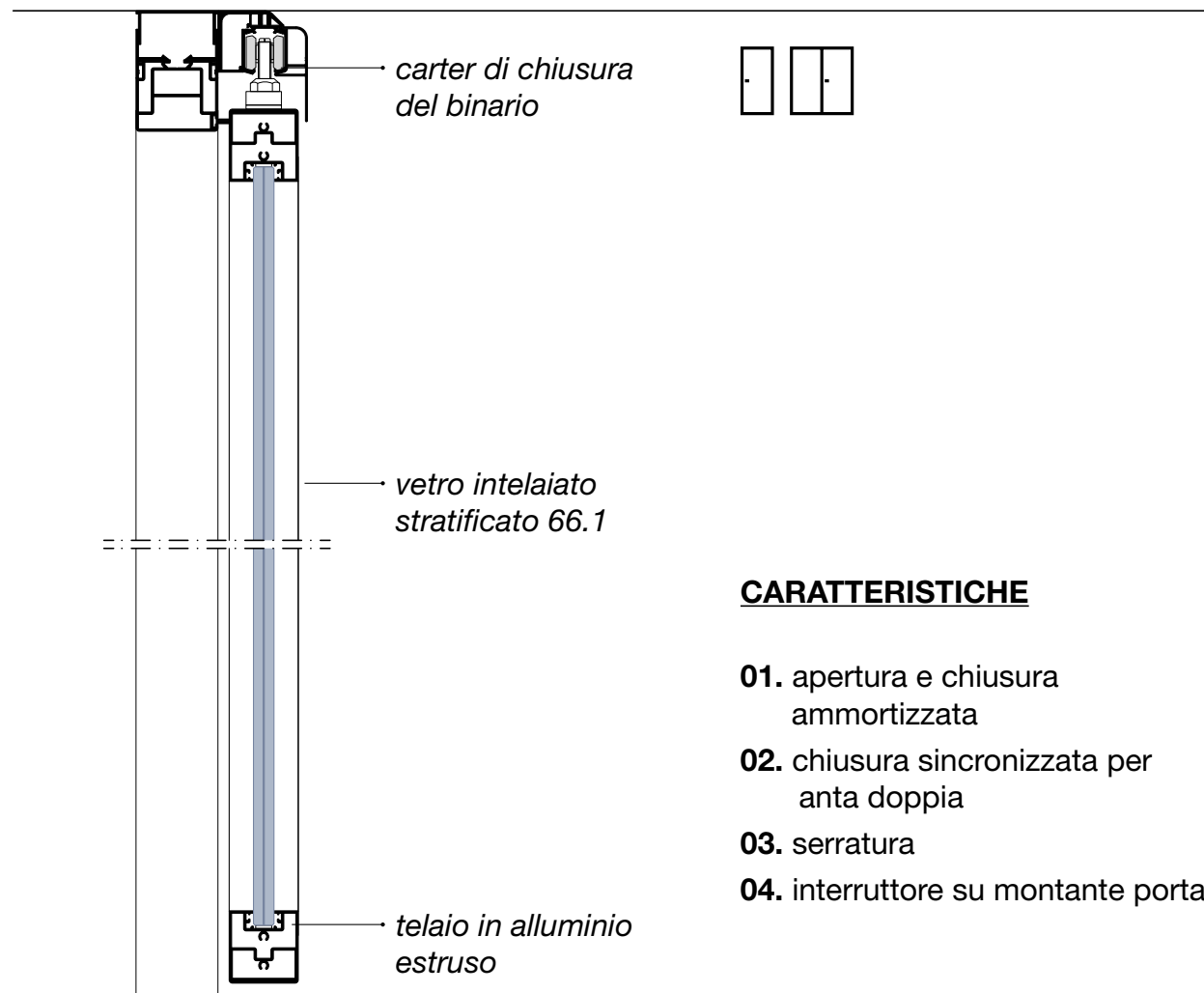
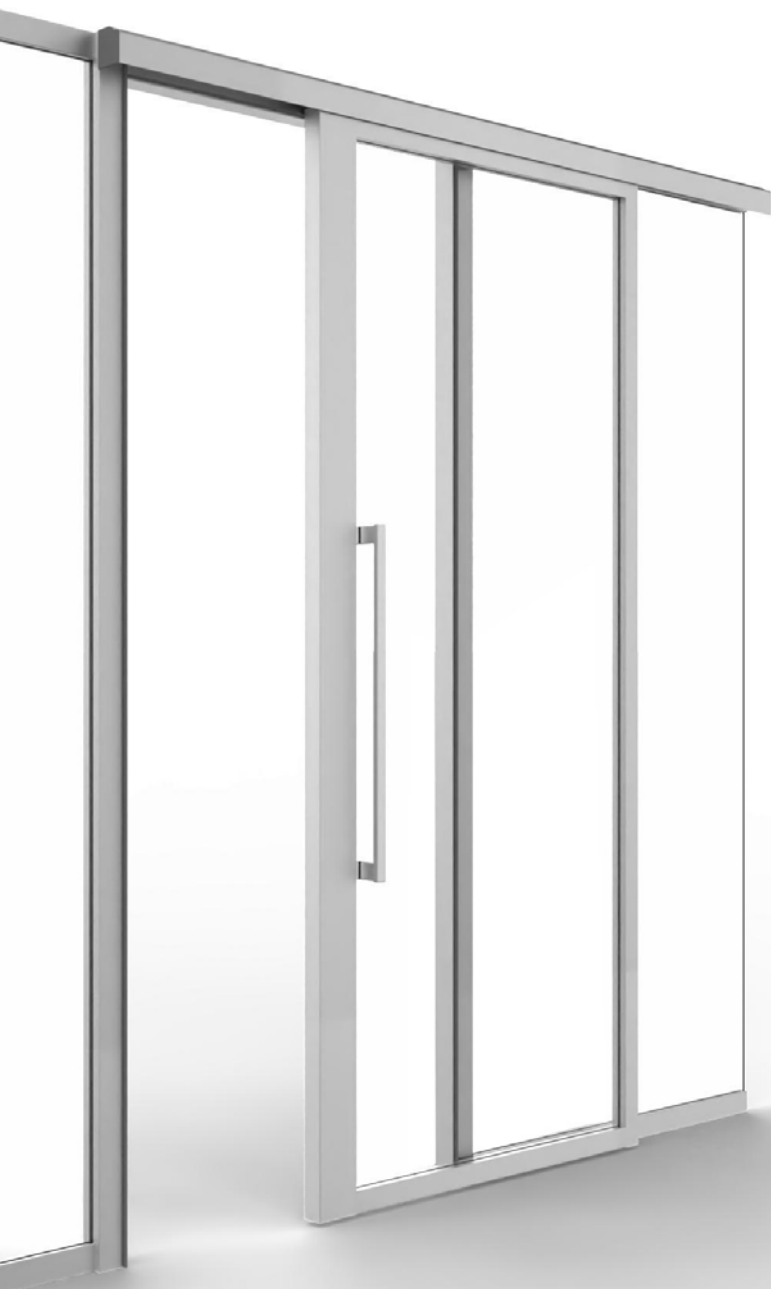

CARATTERISTICHE

- 01. apertura e chiusura ammortizzata
- 02. chiusura sincronizzata per anta doppia
- 03. serratura
- 04. interruttore su montante porta

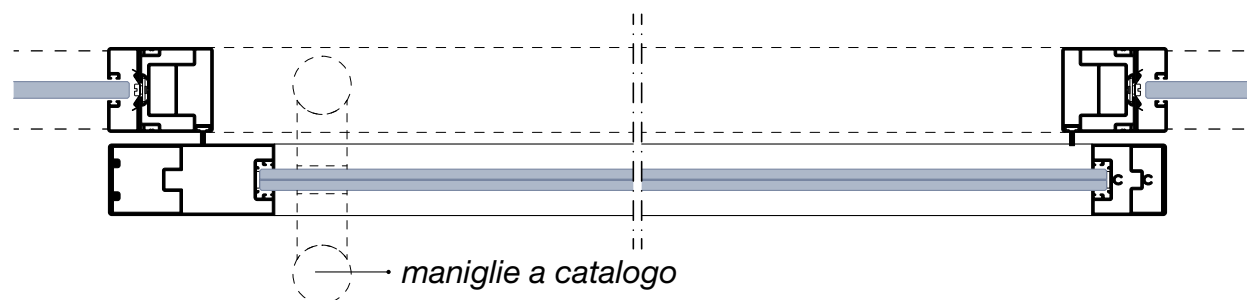

ANTA INTELAIATA SOTTILE sp. 43 mm

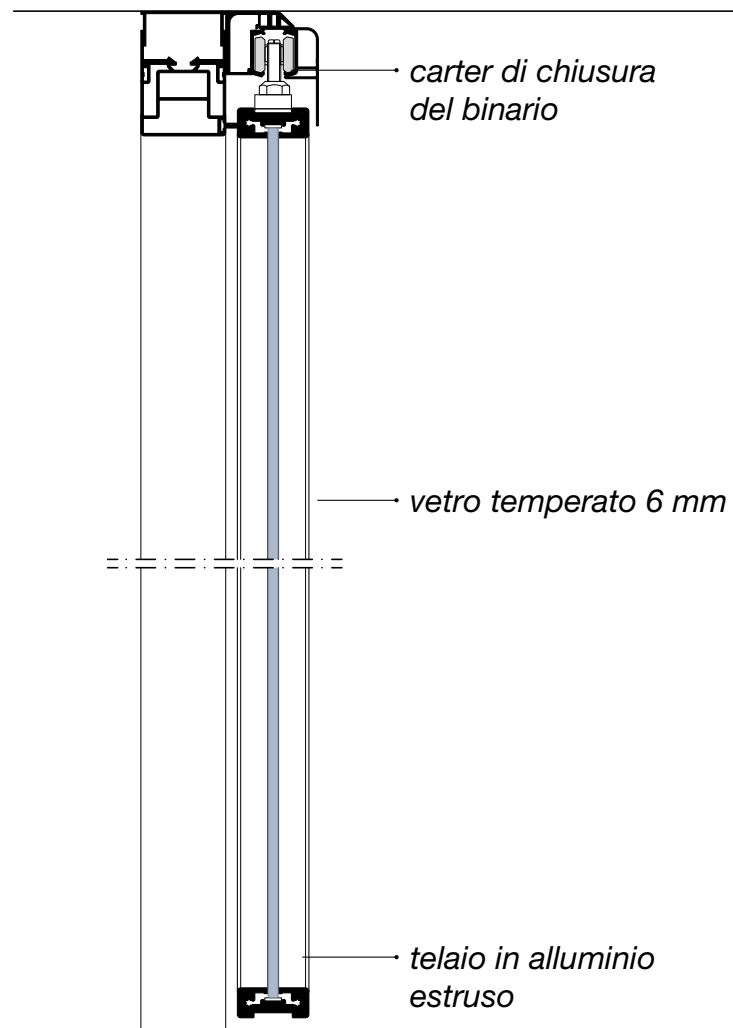

CARATTERISTICHE

- 01. apertura e chiusura ammortizzata
- 02. chiusura sincronizzata per anta doppia
- 03. serratura
- 04. interruttore su montante porta

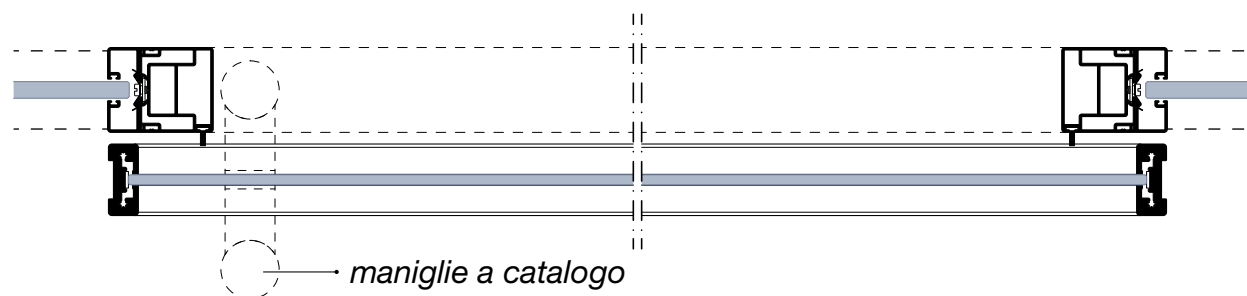

Porte in vetro



ACCIAIO

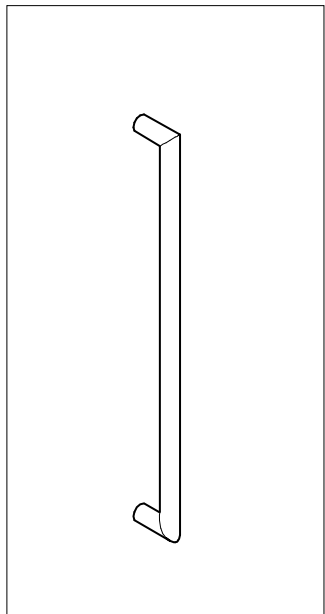

MPOMGH1_H2_H3

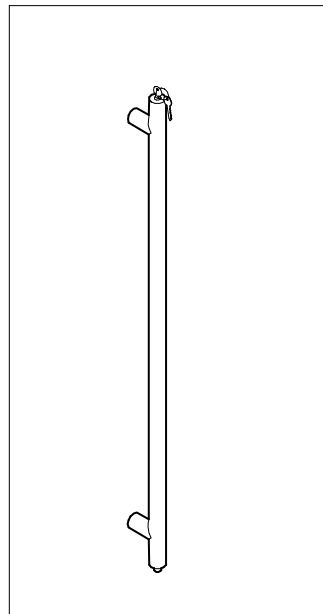

MPOM2

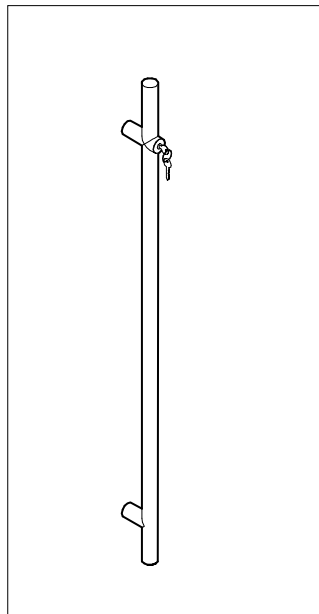

MPOM3

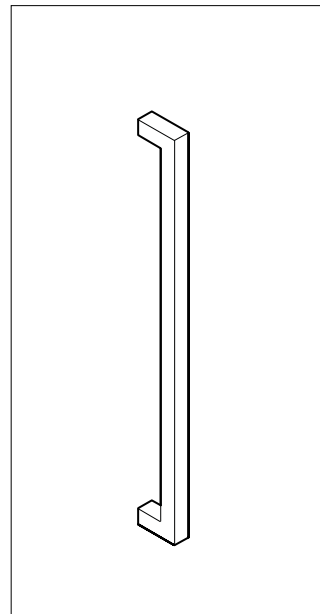

MPOMGH1Q_GH2Q_GH3Q

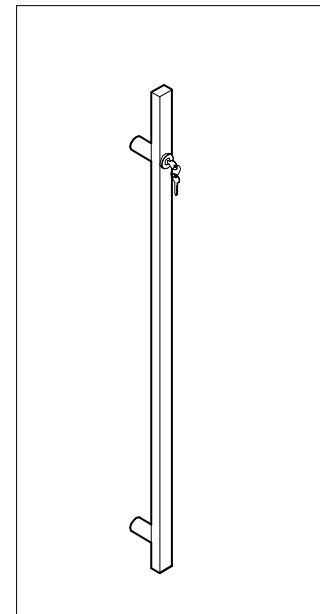

MPOM3Q

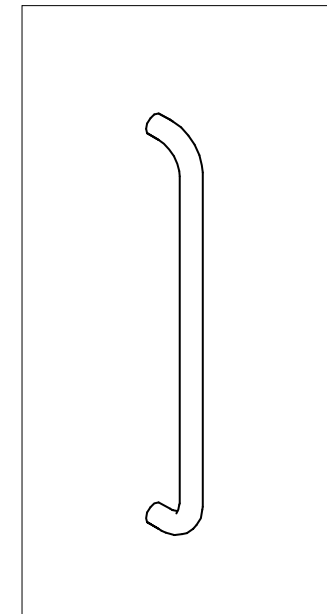

MPOM8

ALLUMINIO

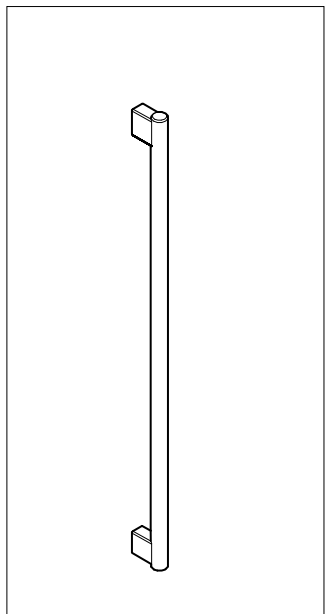

MPOMTH1_TH2

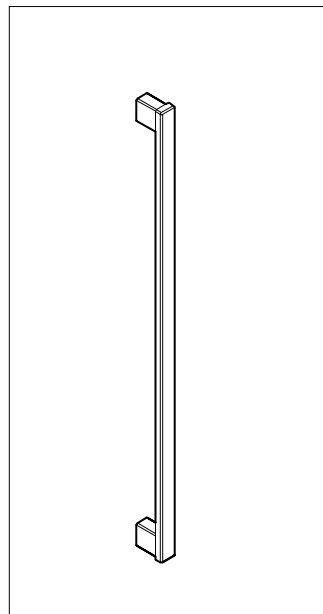

MPOMQH1_QH2

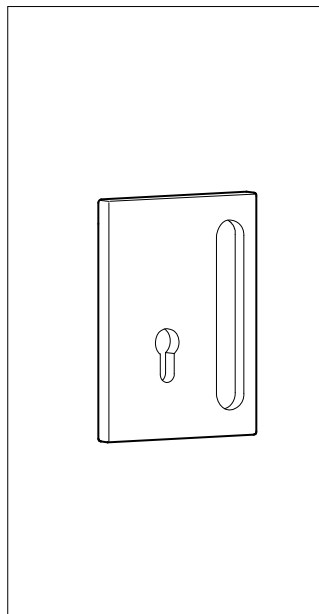

MPOM6

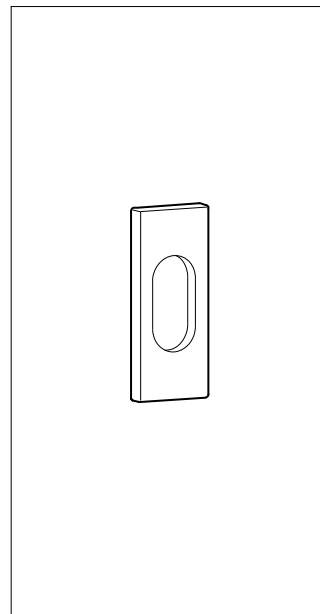

MPOM7

Porte cieche



ACCIAIO

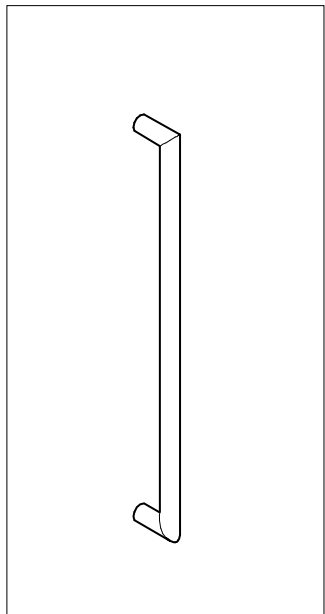

MPOMGH1_H2_H3

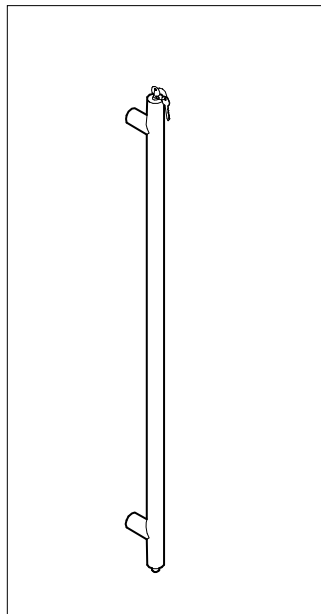

MPOM2

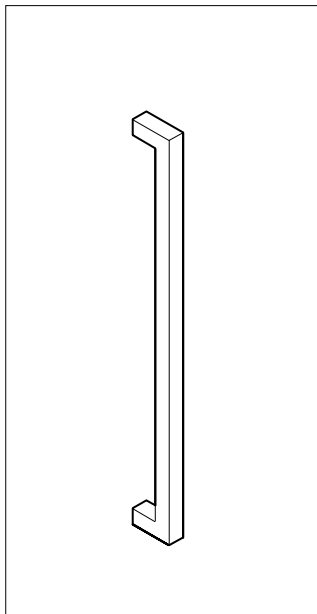

MPOMGH1Q_GH2Q_GH3Q

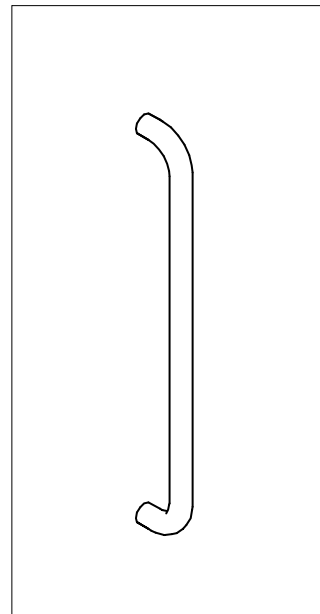

MPOM8

ALLUMINIO

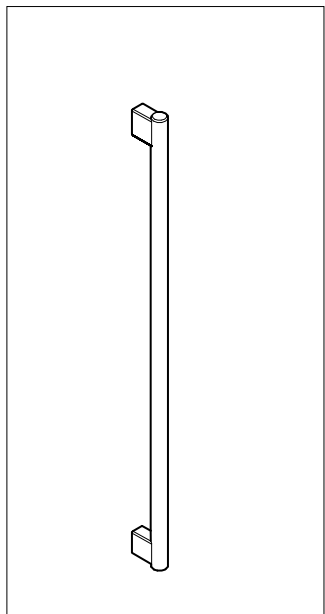

MPOMTH1_TH2

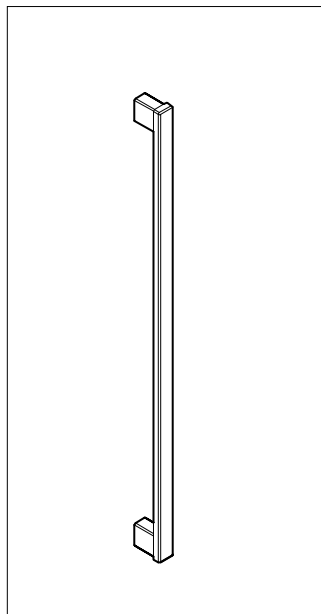

MPOMQH1_QH2

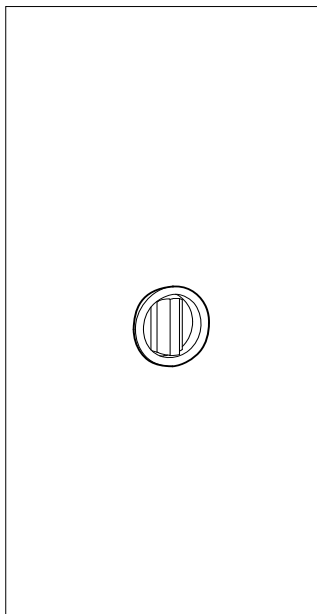

MPOM4

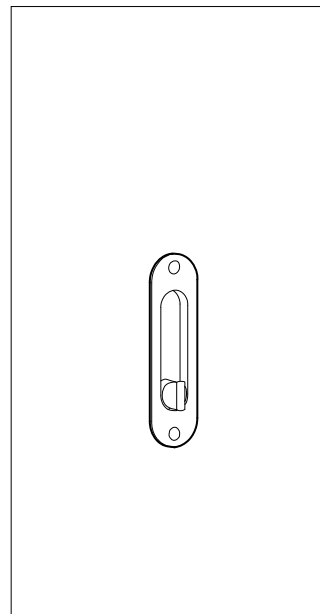

MPOM5

UNICA®

Accessori



Chiudiporta aerei

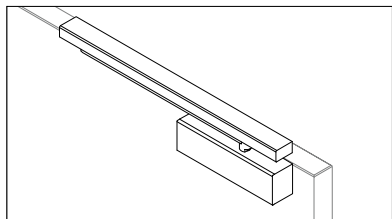

01 esterno a slitta
per anta cieca/intelaiata

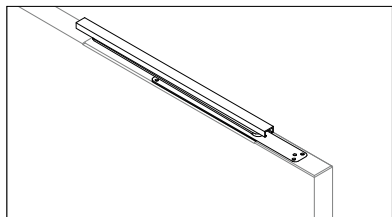

02 a scomparsa
per anta cieca/intelaiata

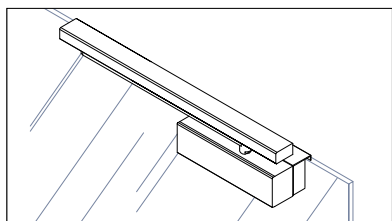

03 esterno a slitta con supporto
per anta in vetro temperato

Chiudiporta a terra

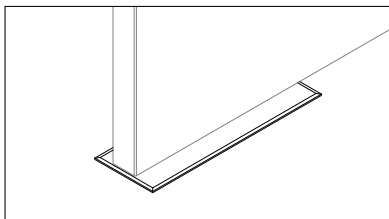

01 a pavimento
per anta cieca

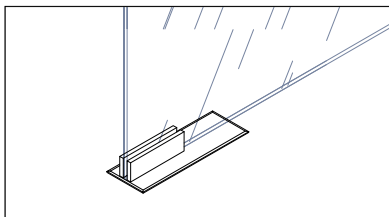

02 a pavimento
per anta in vetro temperato

Cerniere in alluminio

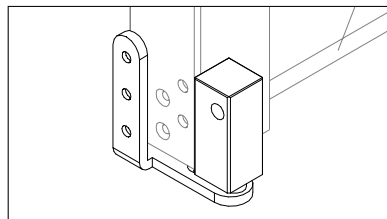

01 a bilico esterno
per anta cieca/intelaiata

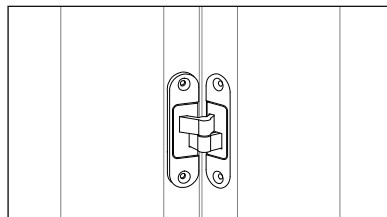

02 a scomparsa
per anta cieca/intelaiata

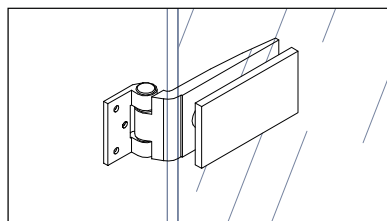

03 apertura 180°
per anta in vetro temperato

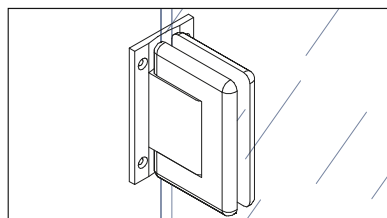

04 va e vieni velocità regolabile
per anta in vetro temperato

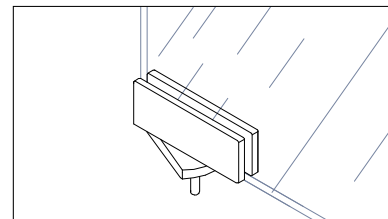

05 va e vieni velocità regolabile
per anta in vetro temperato

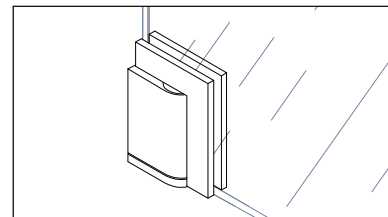

06 va e vieni velocità regolabile
per anta in vetro temperato

Accessori

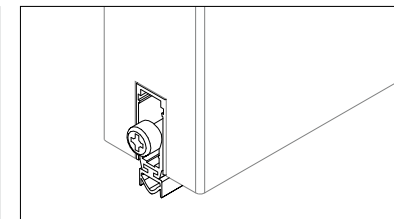

01 antispiffero insonorizzante
per anta cieca/intelaiata

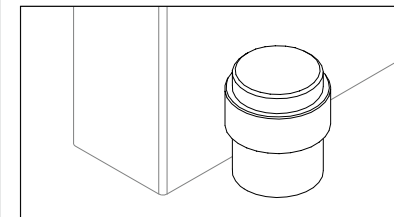

02 fermaporte
per anta cieca/intelaiata/vetro temperato

UNICA®

Finiture



Anodizzati



01 Alluminio naturale

Finiture RAL



01 Bianco



02 Bronzo



02 Nero

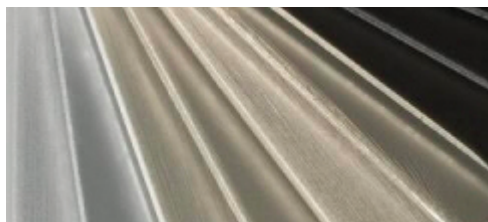

03 Colore a campione



03 Colore a campione

Lucidatura

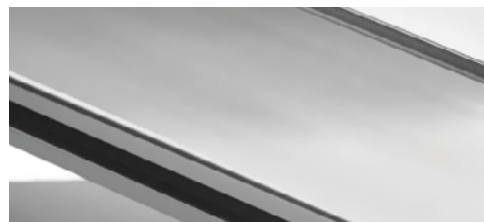

01 Brillantato

Legni



01 Rovere chiaro

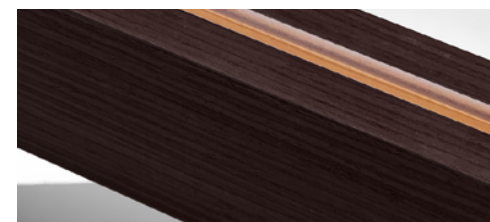

02 Rovere scuro

Pannelli ciechi



CAT. 1

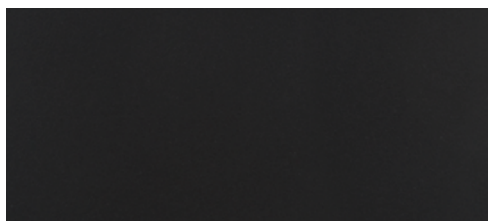

055 Nero grafite

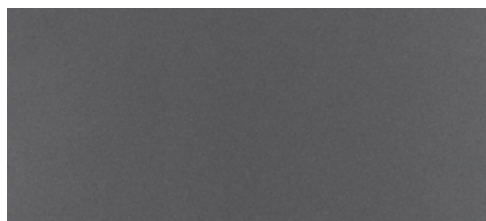

420 Piombo



418 Grigio cenere

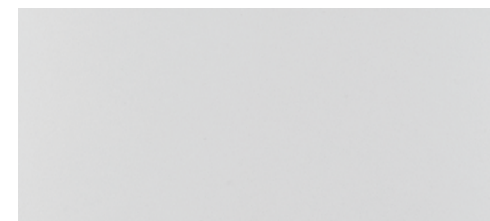

419 Grigio chiaro

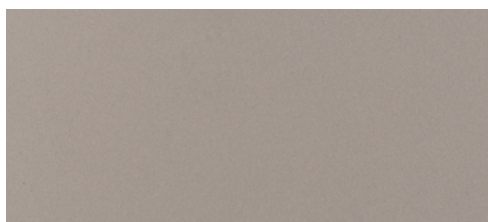

393 Tortora



417 Vaniglia

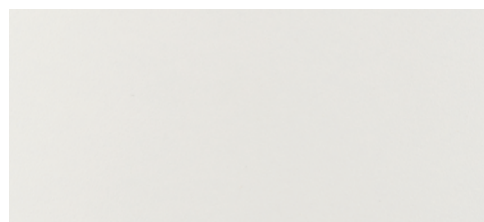

429 Bianco caldo

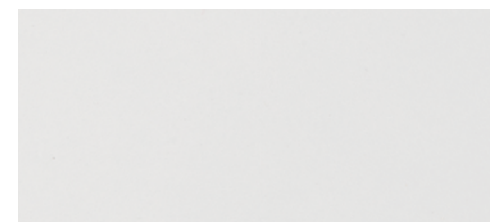

428 Bianco freddo

CAT. 2



422 Argento

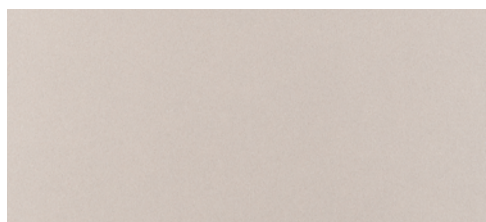

423 Champagne



CAT. 1

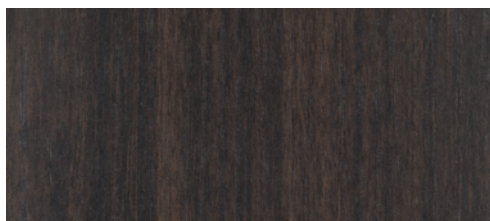

421 Eucalipto

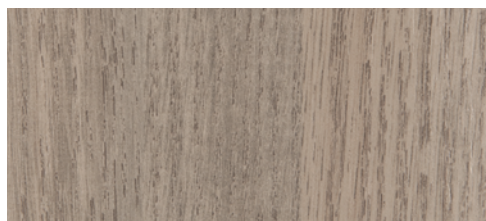

426 Rovere medio



274 Acacia



416 Bianco venato

CAT. 2

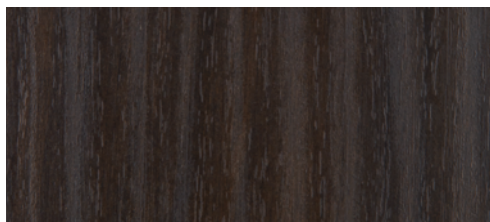

425 Noce scuro

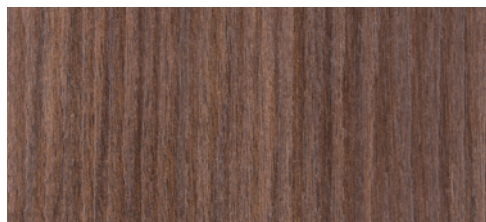

318 Noce medio

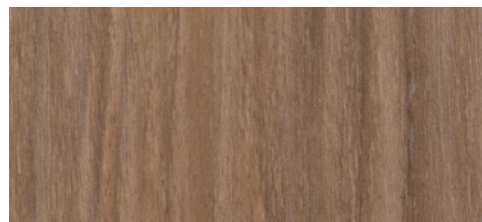

427 Noce chiaro

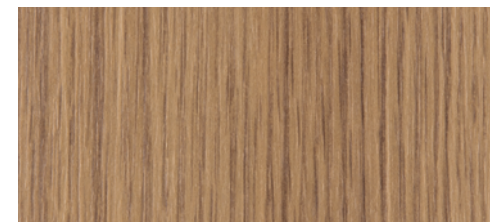

382 Rovere naturale

CAT. 3

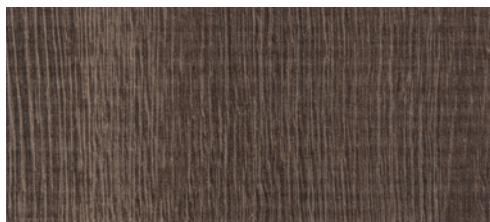

138 Rovere invecchiato - taglio seta

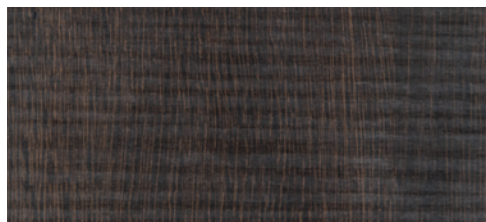

197 Eucalipto - taglio seta

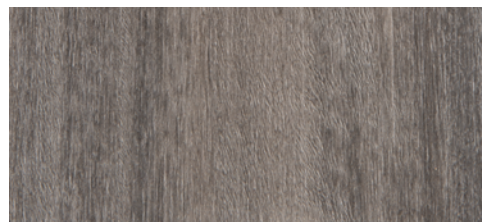

408 Rovere grigio

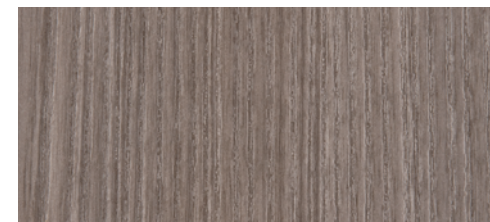

400 Rovere Danubio

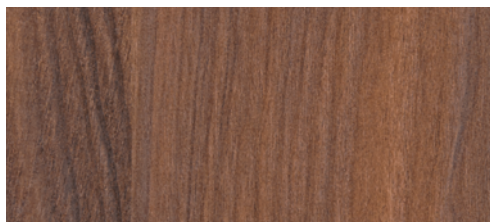

414 Noce rosso

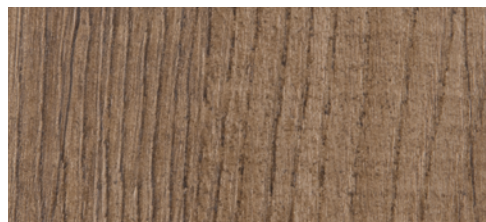

412 Rovere vintage



413 Rovere champagne



410 Rovere chiaro



CAT. 2

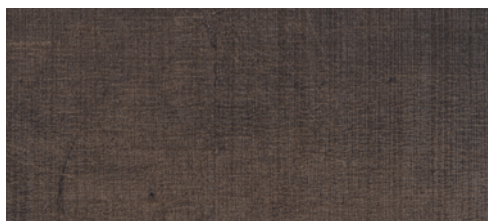

304 Tessuto scuro

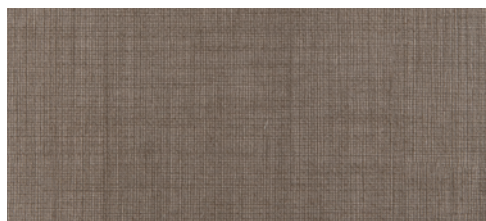

123 Tessuto medio

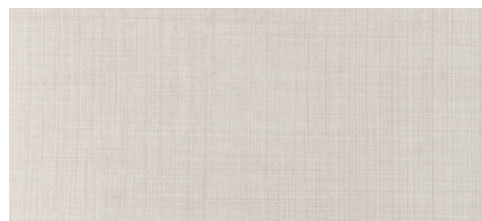

305 Tessuto chiaro



424 Ossido

CAT. 3

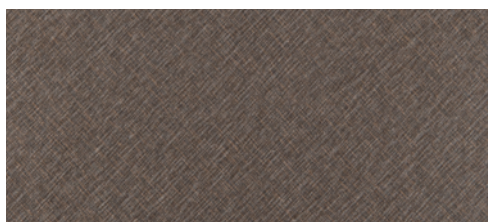

385 Lino bronzo

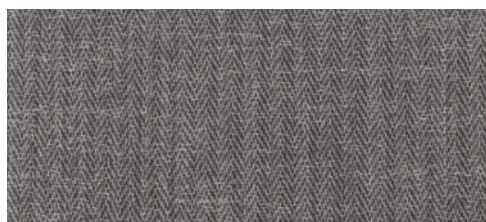

409 Corteccia

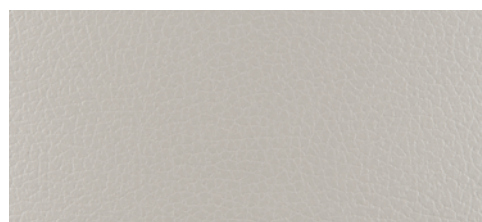

406 Primo fiore grigio

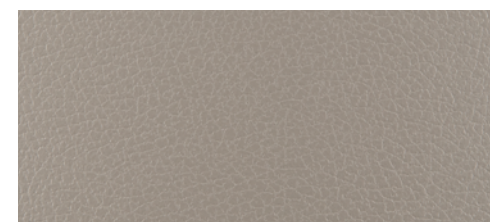

405 Primo fiore tortora



404 Primo fiore beige

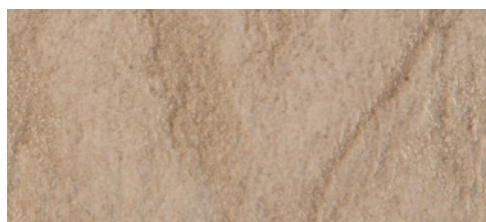

415 Deserto



01 Trasparente



03 Satinato

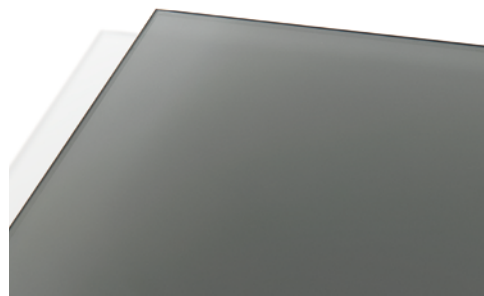

05 Fumé



02 Extrachiaro

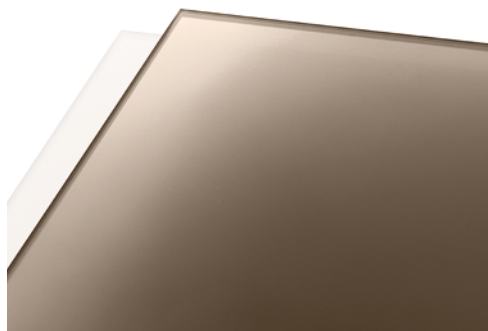

04 Bronzo



06 Verniciato a campione



Etoile s.r.l. - Società Unipersonale

Via D. Albertario, 50 61032 Zona Ind.le Bellocchi - Fano (PU) Italy
P. +39.0721.85.59.34 - F. +39.0721.85.92.14
info@etoilesrl.it - www.etoilesrl.it