



☐ ETOILE

**UNICA®**

---



**Unica è una parete monovetro, doppiovetro e cieca** con funzione separante, fornita in **sette versioni distinte** per le caratteristiche dei vetri e dei profili.



**UNICA® SLIM**  
sezione ridotta

**UNICA® U**  
sezione a "U"

**UNICA® SC1/SC2/SC3**  
sezione rettangolare

**UNICA® R**  
sezione a "T" rovescia

**UNICA® D**  
sezione rettangolare  
doppio vetro

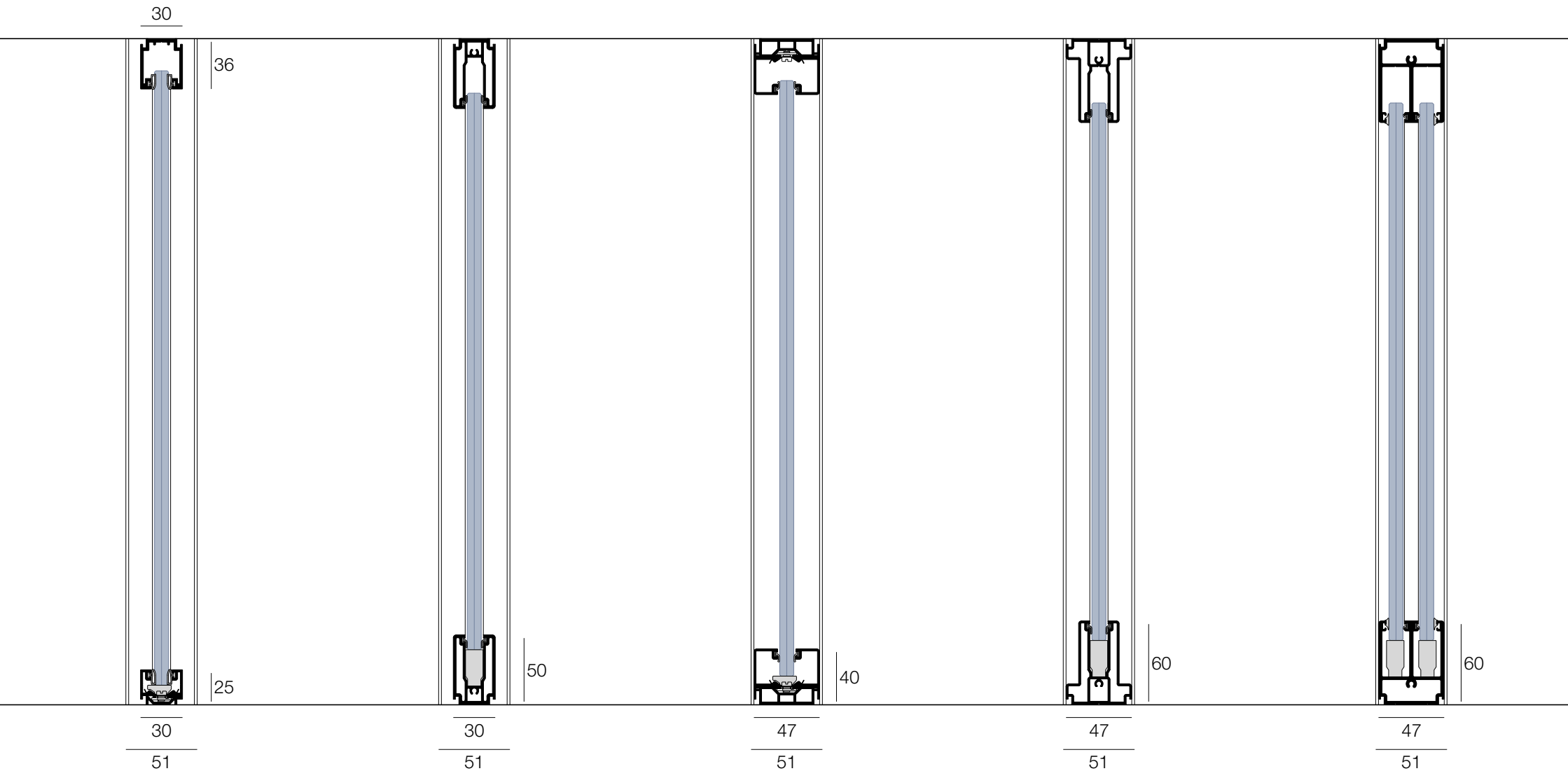







## CARATTERISTICHE

- 01.** Spessore 51 mm
- 02.** Profili a pavimento, a soffitto, angoli e partenze in estruso di alluminio 6060 UNI 9006/1
- 03.** 7 versioni di pareti in vetro - vetro singolo centrale e doppio intelaiato in diversi spessori
- 04.** 3 spessori di vetri di sicurezza o acustici impiegabili
- 05.** Pannello cieco in vari formati autoportante o ancorato al vetro
- 06.** Profili d'angolo fissi e variabili - connessioni 2/3/4 vie
- 07.** Giunzioni verticali tra elementi vetrati in alluminio, policarbonato e biadesivo trasparente
- 08.** Telaio porta cablabile
- 09.** Modulo tecnico ispezionabile
- 10.** 7 versioni di porte battenti - cieche, in vetro temperato e intelaiate
- 11.** 5 versioni di porte scorrevoli esterne - cieche, in vetro temperato e intelaiate

**UNICA® SLIM**

---







- 01.** Spessore 51 mm
- 02.** Profilo fermavetro - dimensioni 30 x 25 mm
- 03.** Profili a pavimento, a soffitto, angoli e partenze in estruso di alluminio 6060 UNI 9006/1
- 04.** Vetro singolo centrale - spessore 55.1/66.1/66.2 o temperato 10/12 mm
- 05.** Pannello cieco in vari formati autoportante o ancorato al vetro
- 06.** Profili d'angolo fissi e variabili - connessioni 2/3/4 vie
- 07.** Giunzioni verticali tra elementi vetrati in alluminio, policarbonato e biadesivo trasparente
- 08.** Telaio porta cablabile
- 09.** Modulo tecnico ispezionabile
- 10.** 7 versioni di porte battenti - cieche, in vetro temperato e intelaiate
- 11.** 5 versioni porte scorrevoli esterne - cieche, in vetro temperato e intelaiate

- 01.** Vetro 55.1 - **32 dB**
- 02.** Vetro 55 + 0,5 PVB acustico + isolante - **35 dB**
- 03.** Vetro 66.1 - **36 dB**
- 04.** Vetro 66.2 + pellicola acustica - **38 dB**

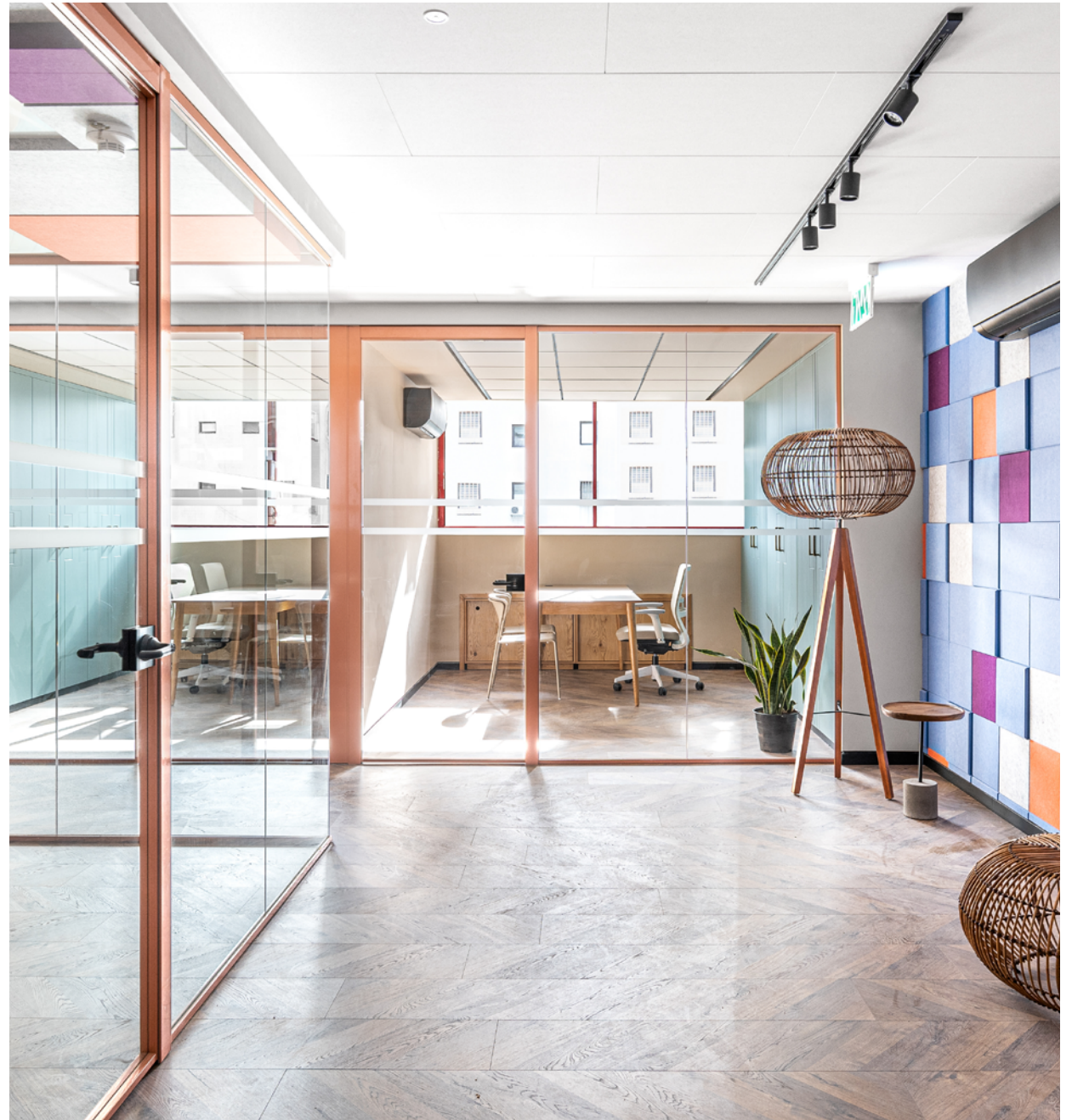

# Partenze

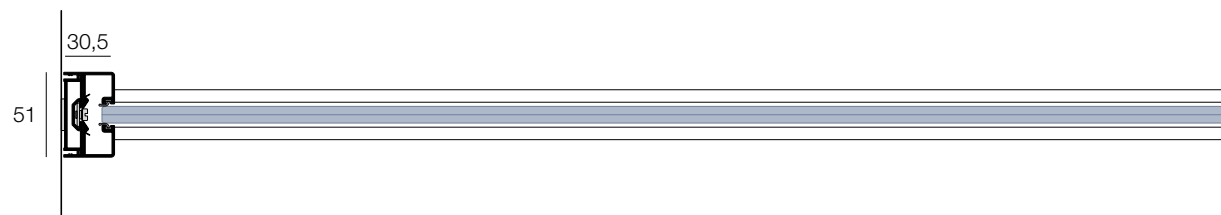
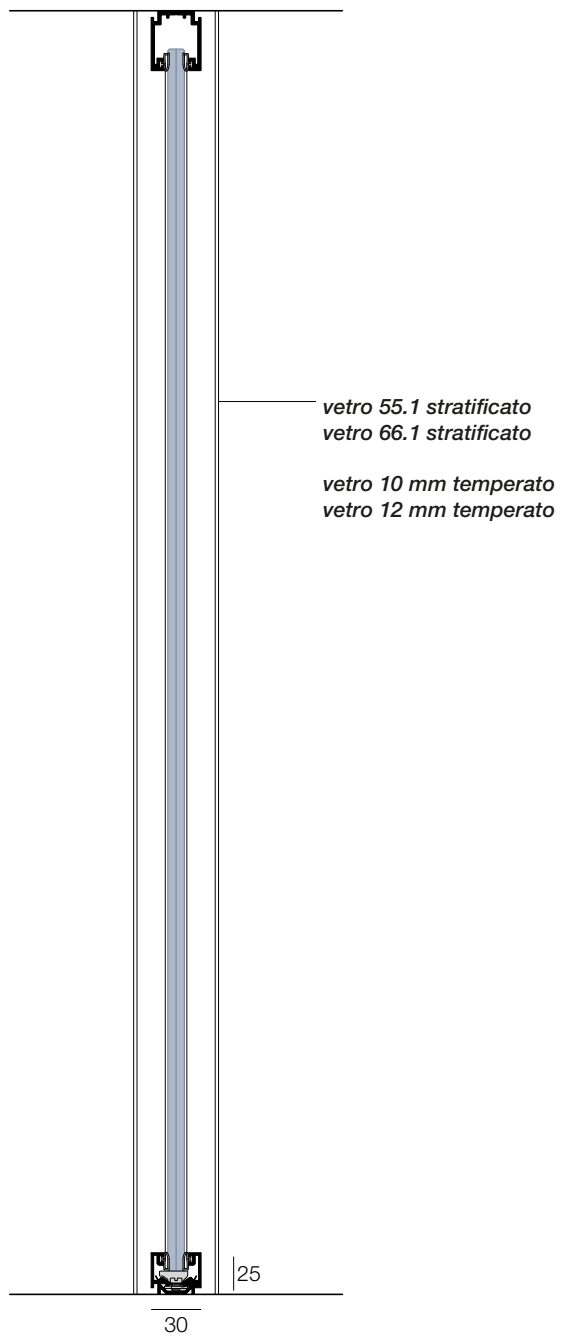

**Partenza fissa da parete**

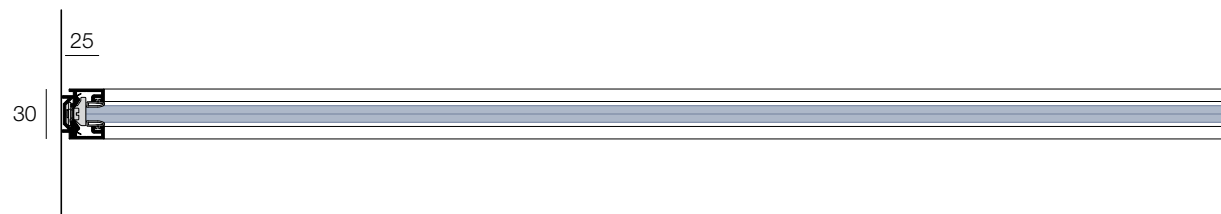

**Partenza fissa da parete**

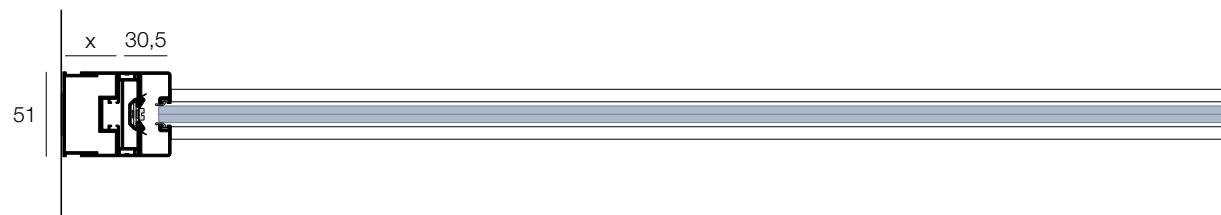

**Partenza telescopica da parete**

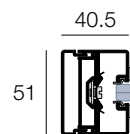

Profilo terminale

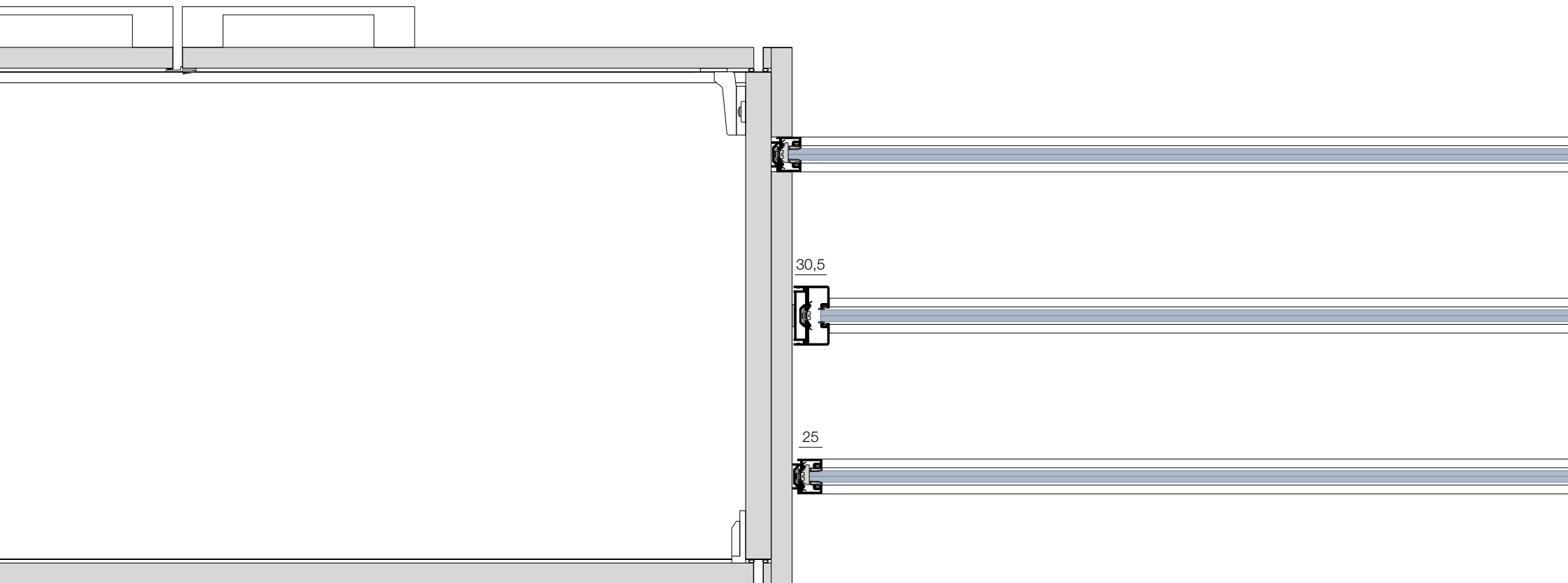

Partenze da contenitore





variabile



**Connessione  
in alluminio**



**Connessione  
in policarbonato**



**Connessione  
con biadesivo tecnico**

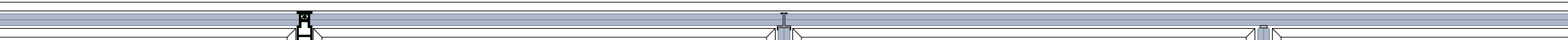

**Connessione  
a tre vie  
in alluminio**

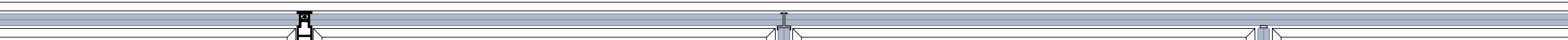

**Connessione  
a tre vie  
in policarbonato**

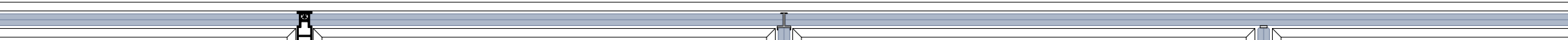

**Connessione  
a tre vie  
con biadesivo tecnico**

# Angoli



Angolo a 90°  
in policarbonato/alluminio

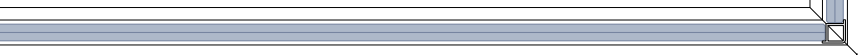

Angolo a 90°  
con biadesivo tecnico



Angolo 2 vie

Angolo variabile

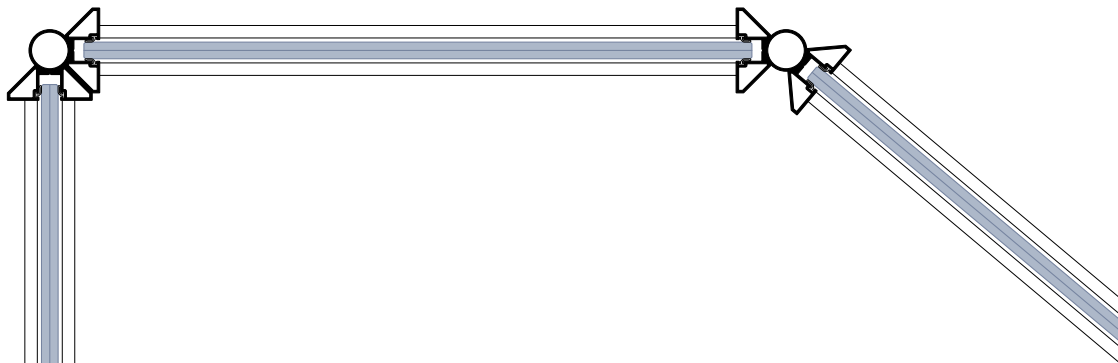

Angolo 3 vie

Angolo 4 vie

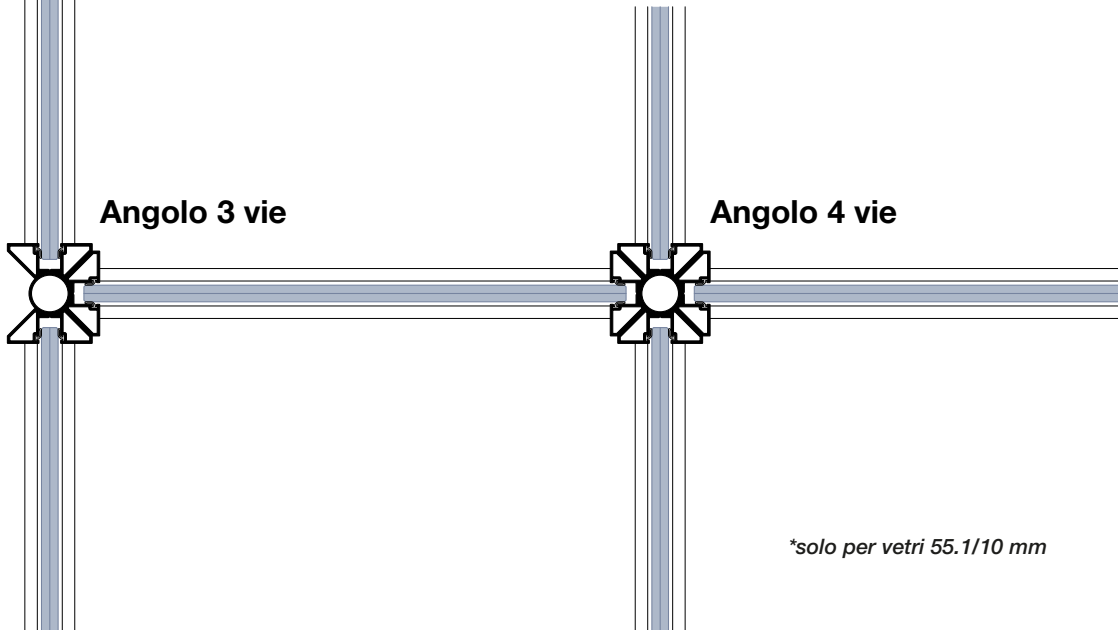

*\*solo per vetri 55.1/10 mm*

# Cablaggio e modulo tecnico della porta a battente



## Modulo tecnico

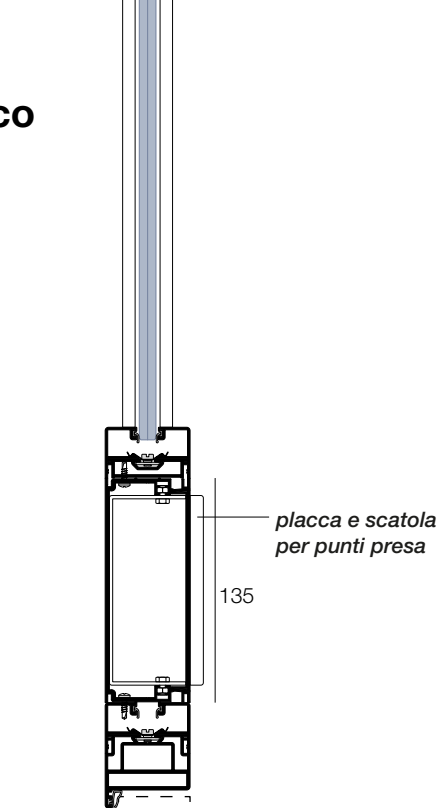

## Soluzione di cablaggio

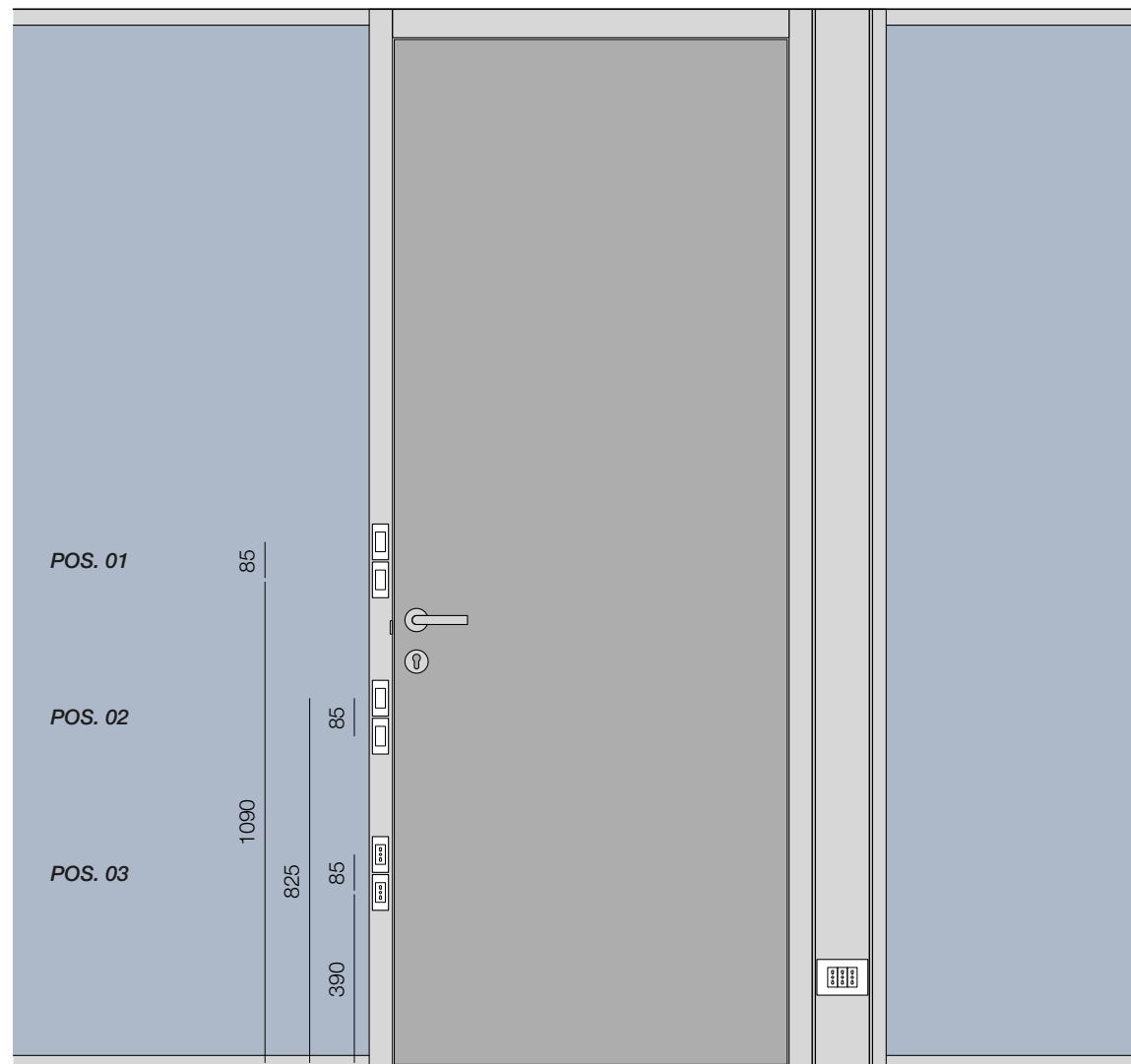
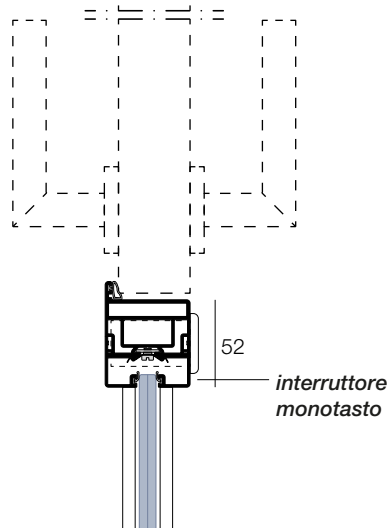

*\*posizioni possibili di interruttori e prese su telaio porta*

# Cablaggio e modulo tecnico della porta scorrevole



## Modulo tecnico

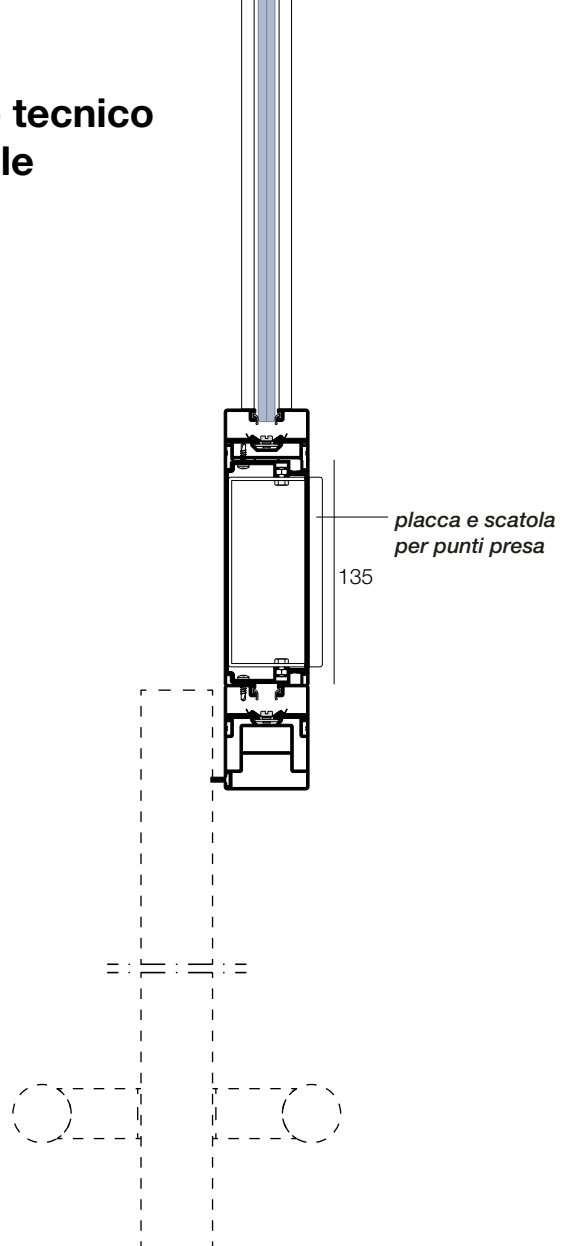

## Soluzione di cablaggio

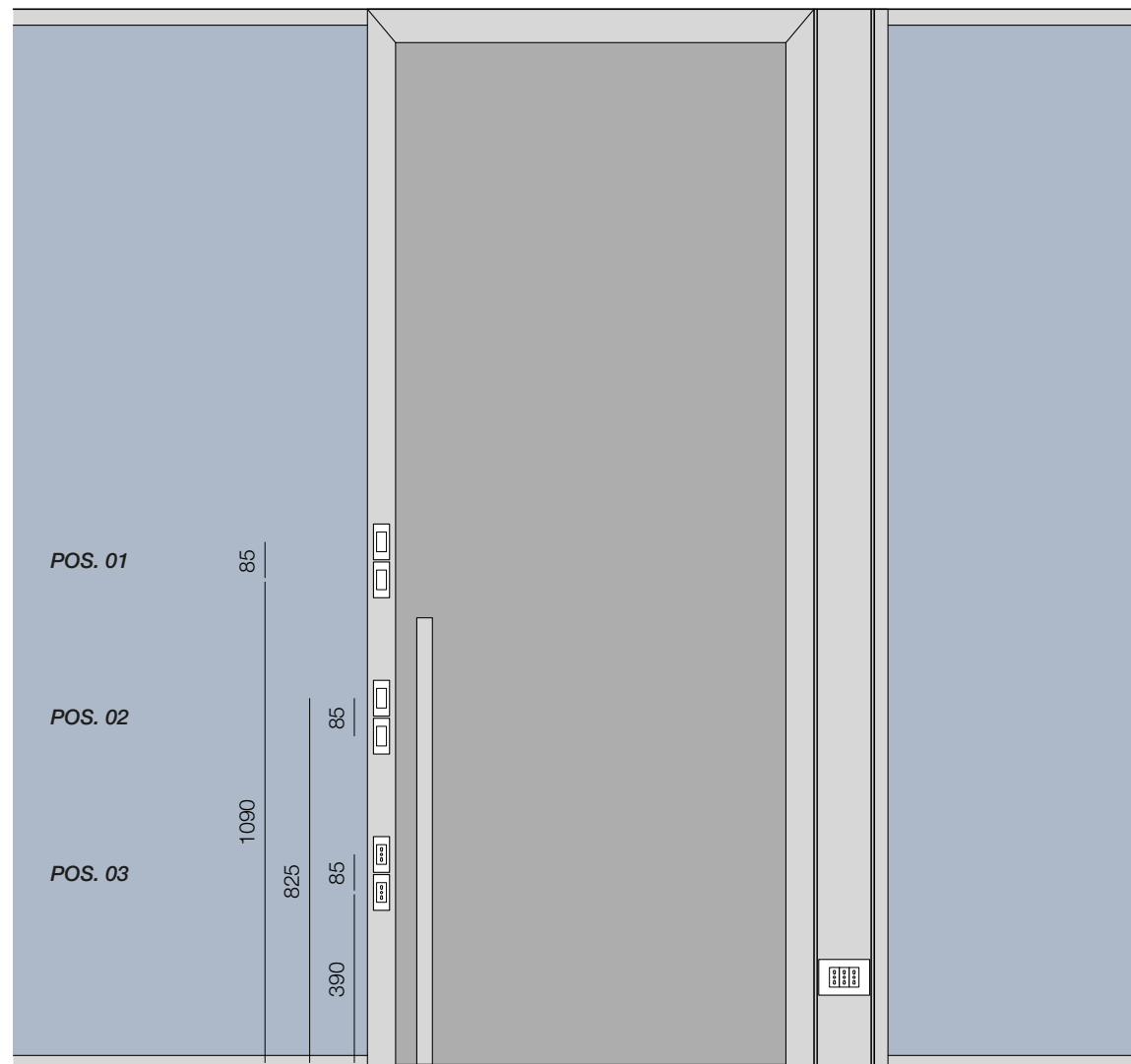
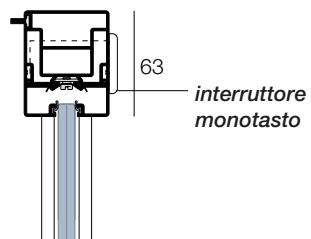

\*posizioni possibili di interruttori e prese su telaio porta



# Pannello cieco



## Parete con pannello sospeso

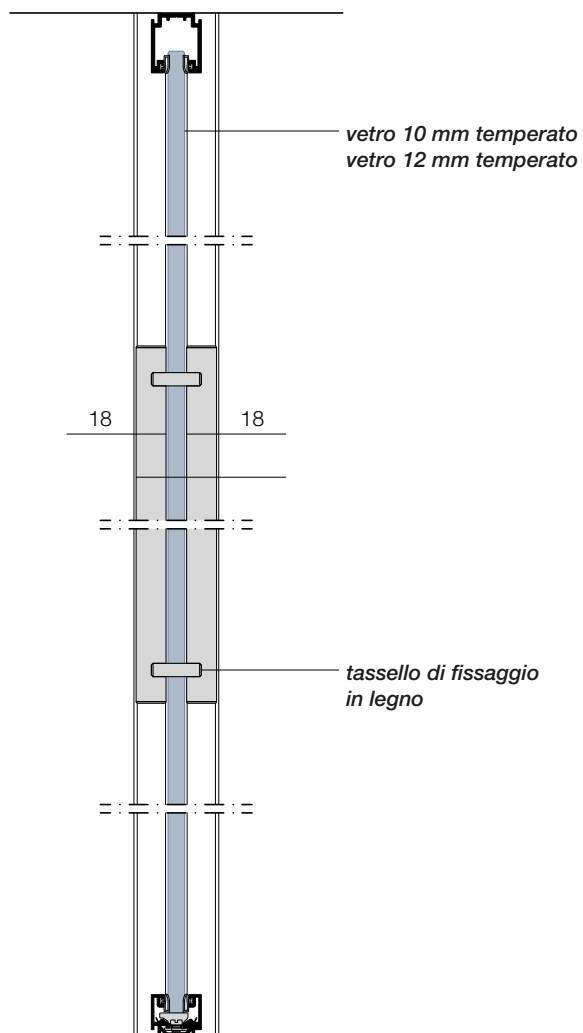

## Parete con pannello intero

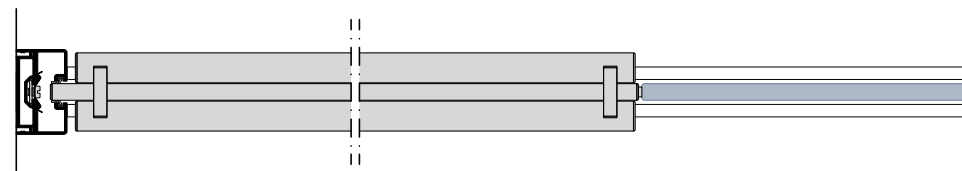
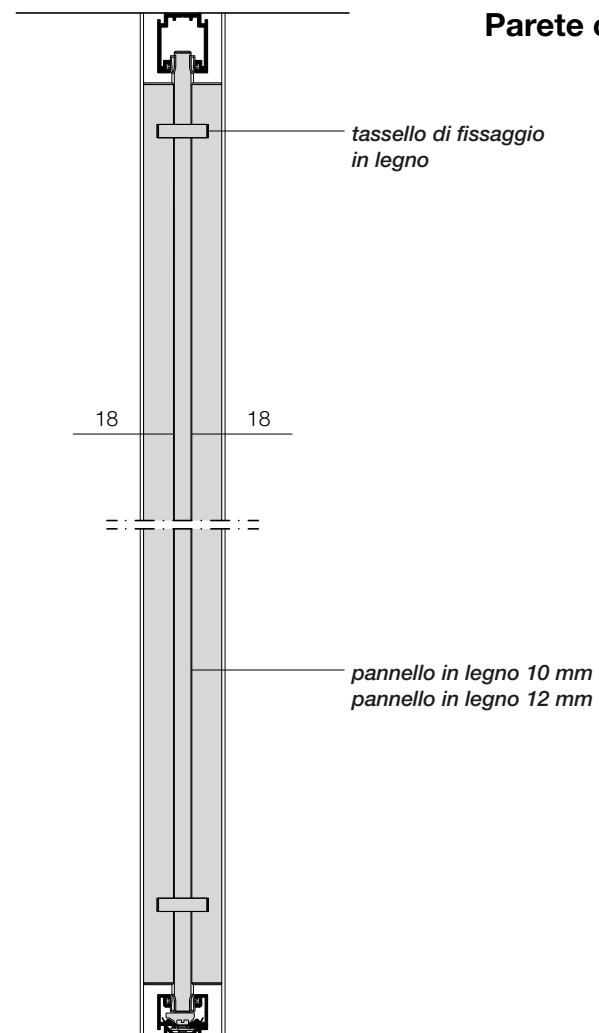

**UNICA® U**

---

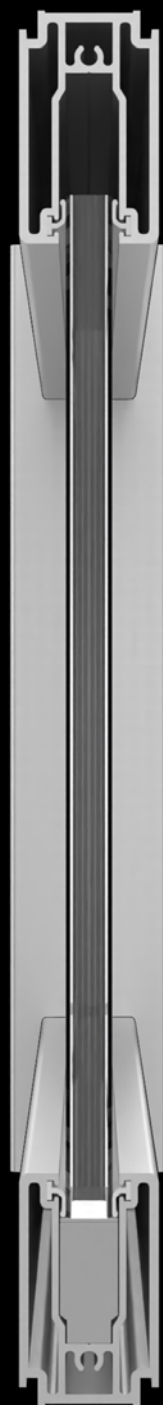



- 01.** Spessore 51 mm
- 02.** Profilo fermavetro - dimensioni 30 x 50 mm
- 03.** Profili a pavimento, a soffitto, angoli e partenze in estruso di alluminio 6060 UNI 9006/1
- 04.** Vetro singolo centrale - spessore 55.1/55.2 o temperato 10 mm
- 05.** Pannello cieco in vari formati autoportante o ancorato al vetro
- 06.** Profili d'angolo fissi e variabili - connessioni 2/3/4 vie
- 07.** Giunzioni verticali tra elementi vetrati in alluminio, policarbonato e biadesivo trasparente
- 08.** Telaio porta cablabile
- 09.** Modulo tecnico ispezionabile
- 10.** 7 versioni di porte battenti - cieche, in vetro temperato e intelaiate
- 11.** 5 versioni di porte scorrevoli esterne - cieche, in vetro temperato e intelaiate

**01.** Vetro 55.1 - **32 dB**

**02.** Vetro 55 + 0,5 PVB acustico + isolante - **35 dB**





# Partenze

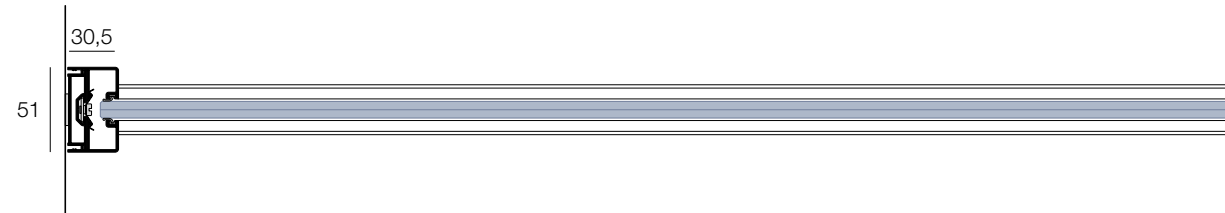
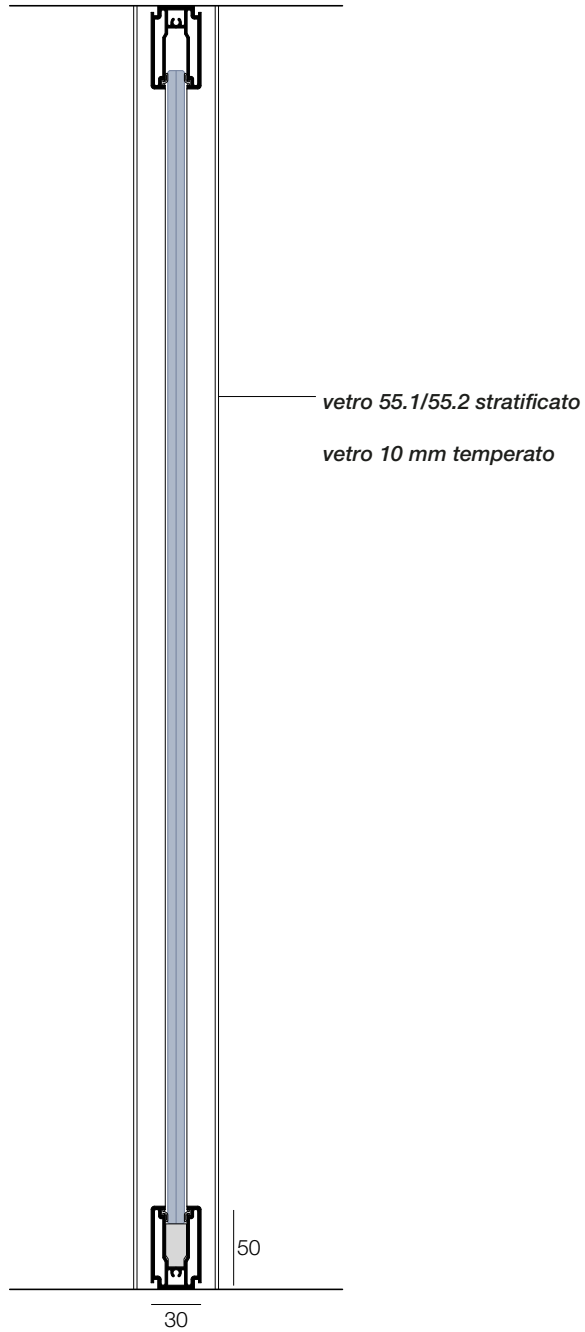

**Partenza fissa da parete**

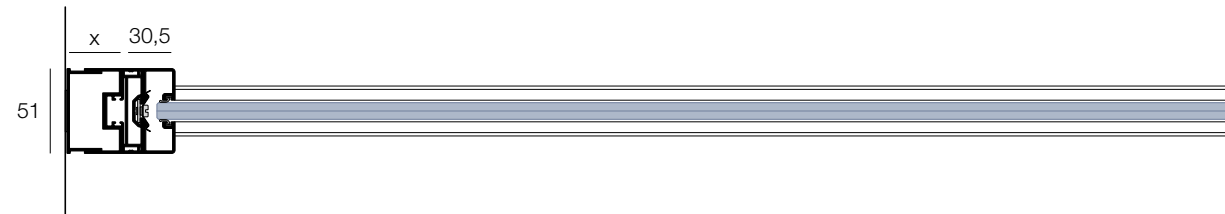

**Partenza telescopica da parete**

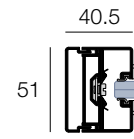

**Profilo terminale**

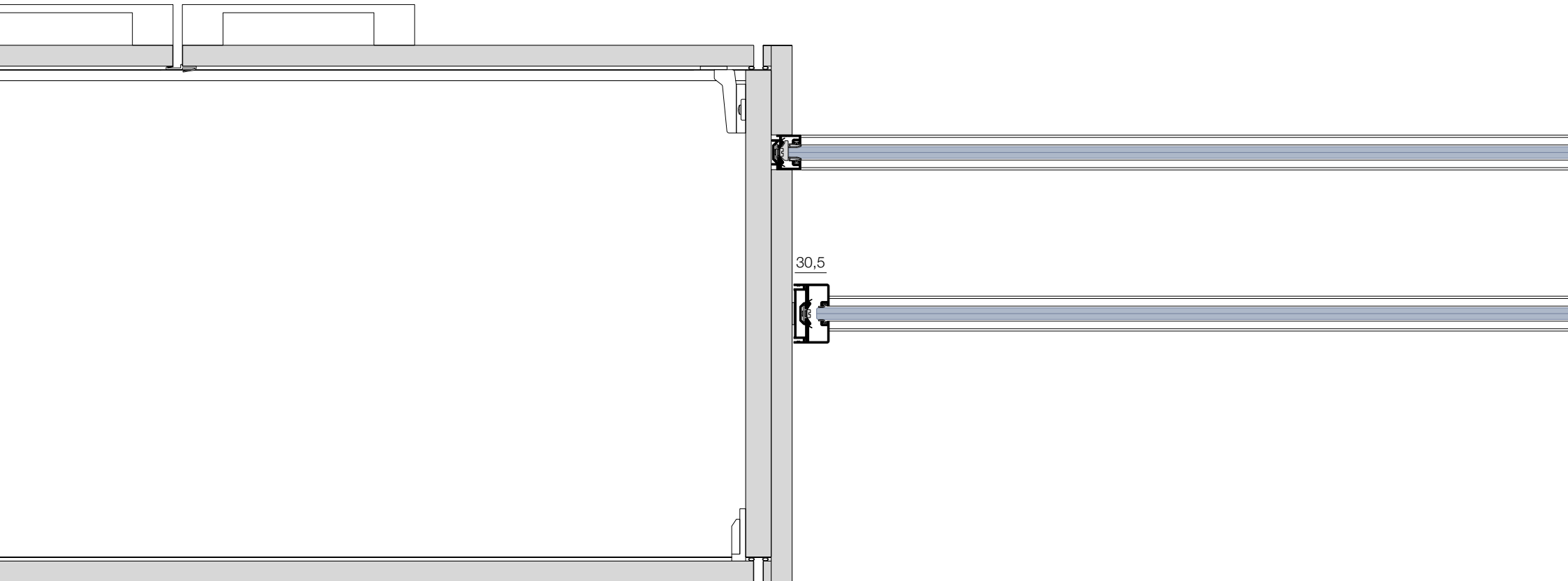

**Partenze da contenitore**



variabile

**Connessione  
in alluminio**

**Connessione  
in policarbonato**

**Connessione  
con biadesivo tecnico**

**Connessione  
a tre vie  
in alluminio**

**Connessione  
a tre vie  
in policarbonato**

**Connessione  
a tre vie  
con biadesivo tecnico**

# Angoli



Angolo a 90°  
in policarbonato/alluminio

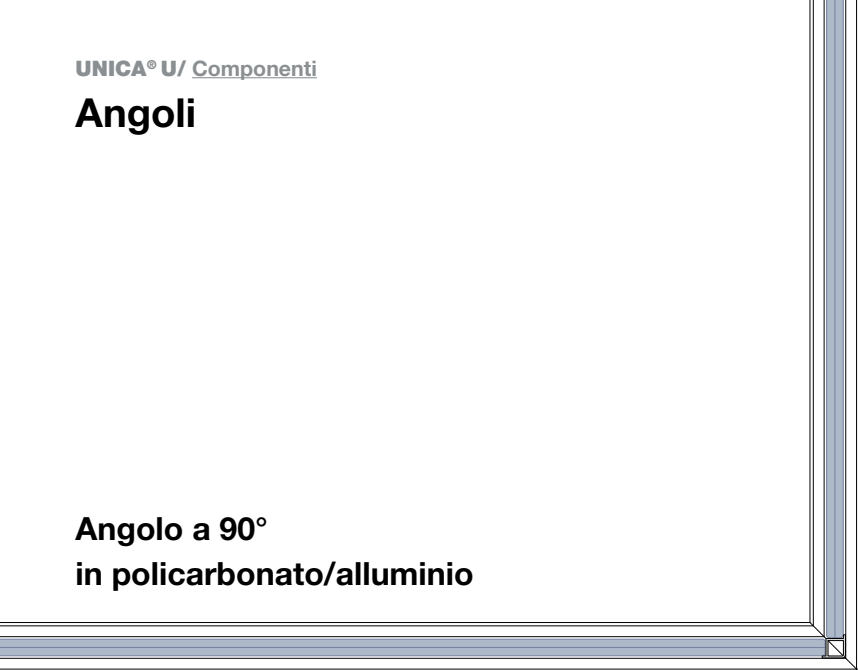

Angolo a 90°  
con biadesivo tecnico



Angolo 2 vie

Angolo variabile

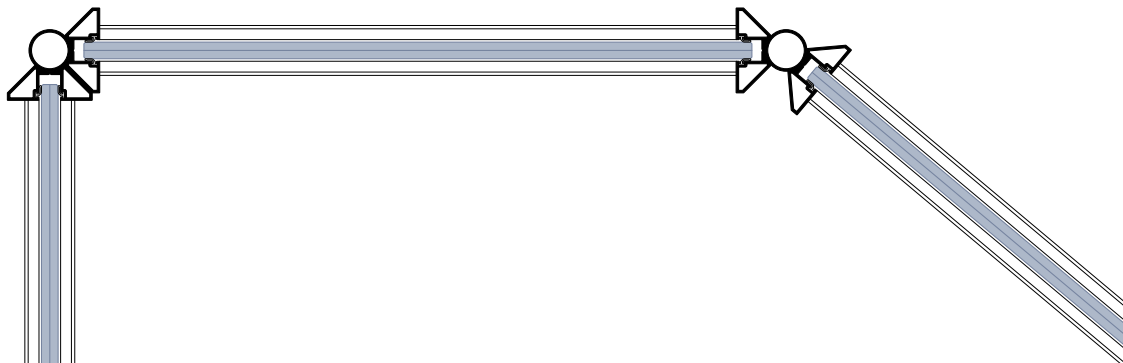

Angolo 3 vie

Angolo 4 vie

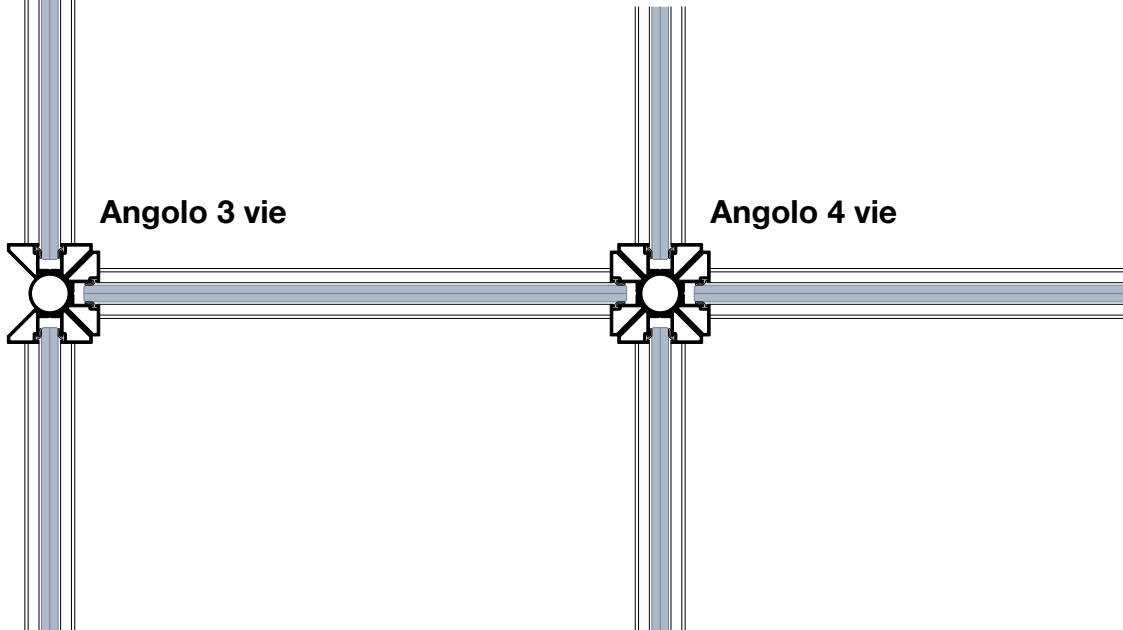

# Cablaggio e modulo tecnico della porta a battente



## Modulo tecnico

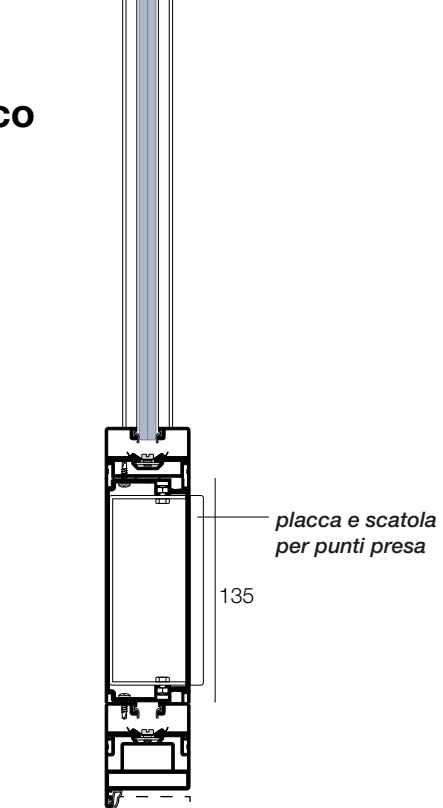

## Soluzione di cablaggio

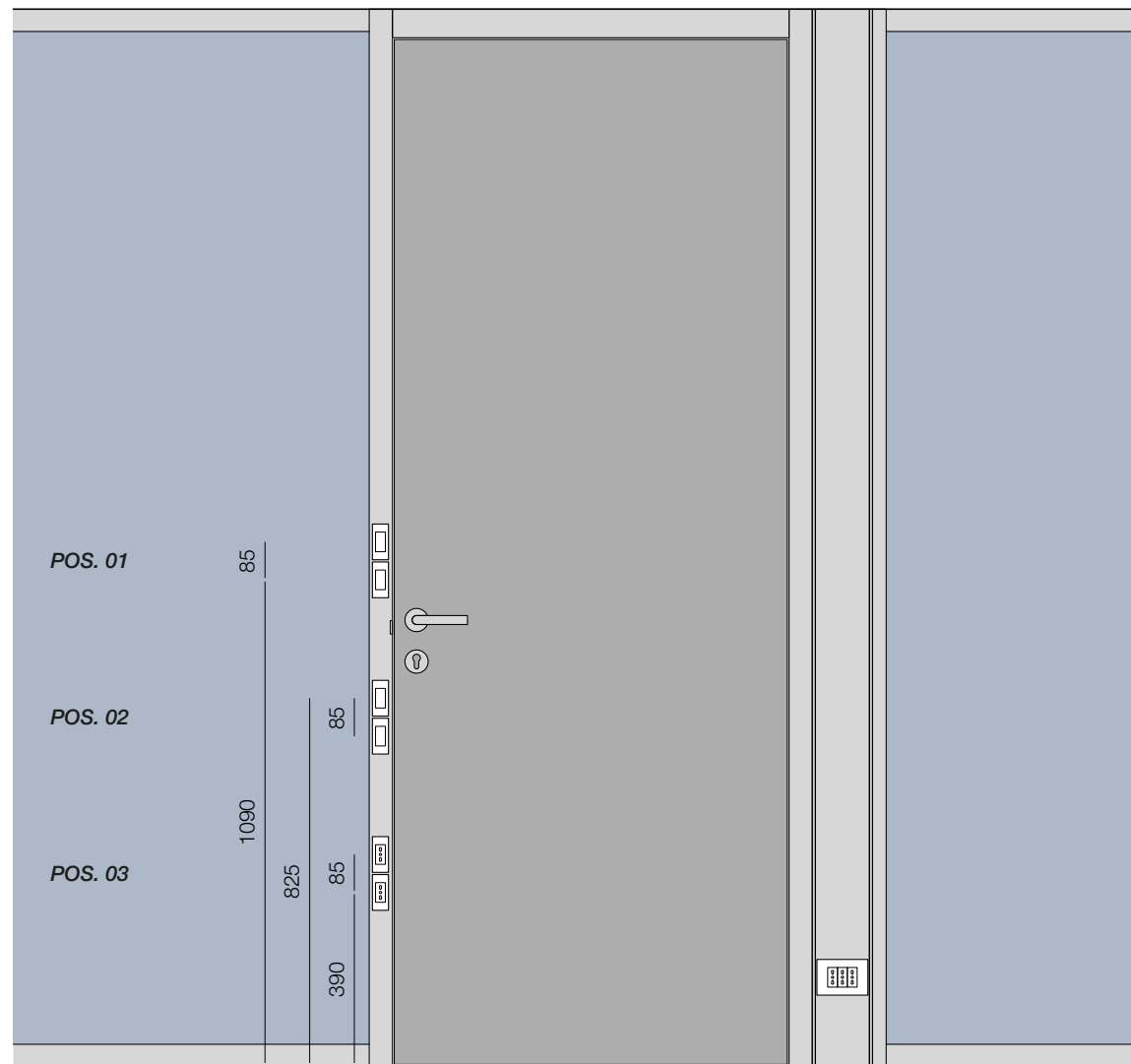
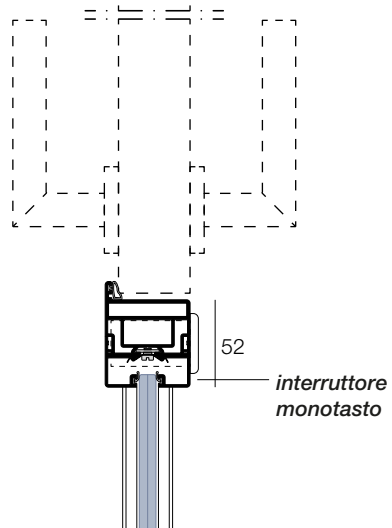

\*posizioni possibili di interruttori e prese su telaio porta

# Cablaggio e modulo tecnico della porta scorrevole



## Modulo tecnico

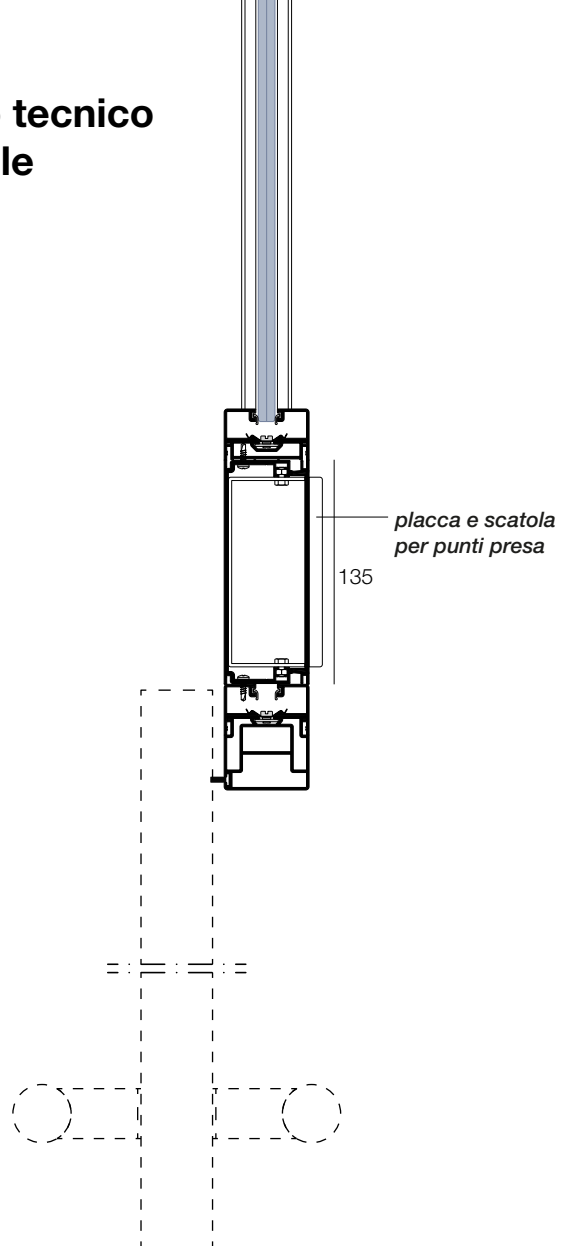

## Soluzione di cablaggio

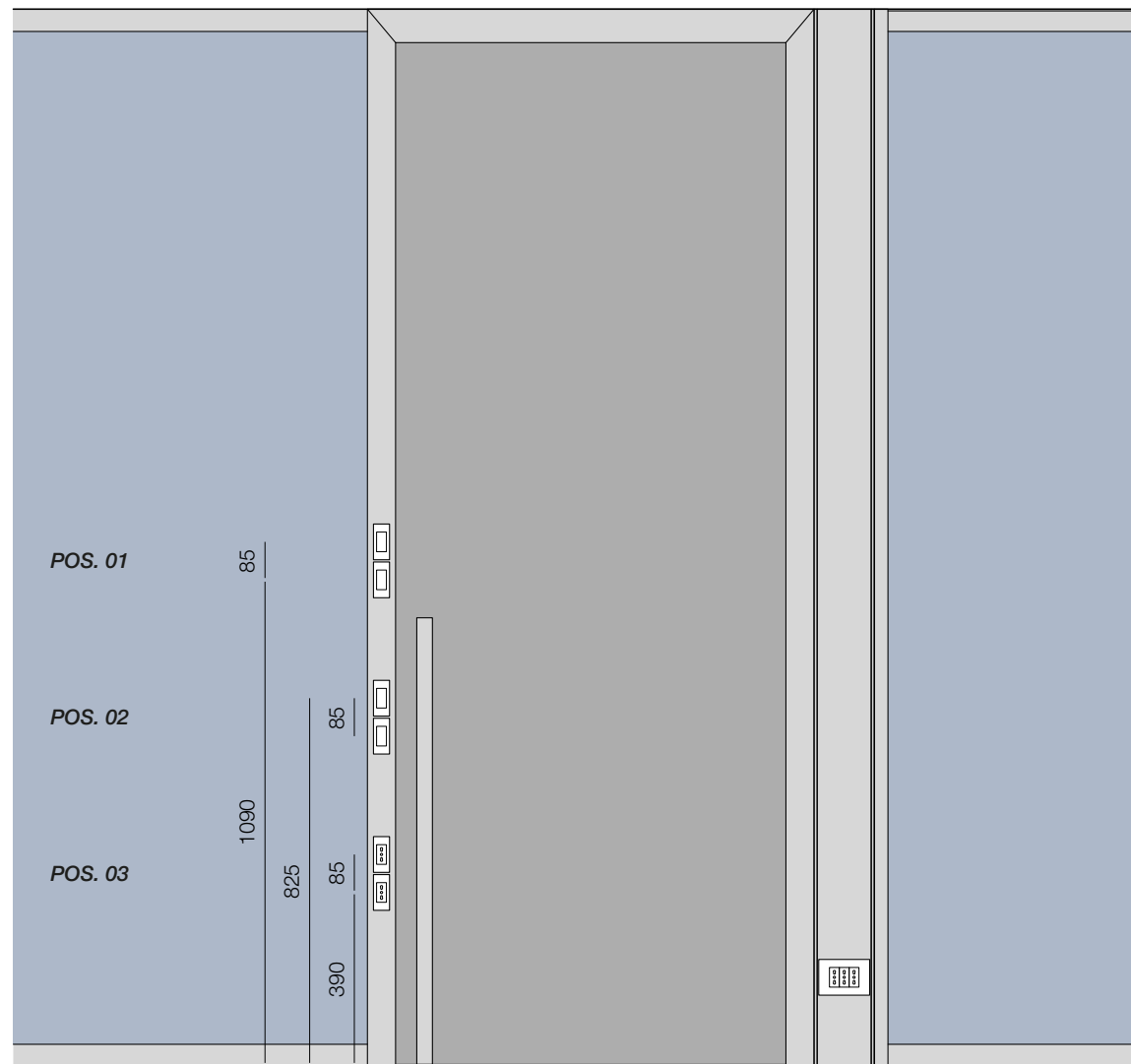
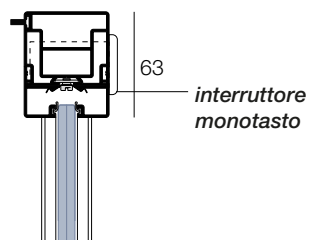

*\*posizioni possibili di interruttori e prese su telaio porta*



# Pannello cieco



### Parete con pannello sospeso

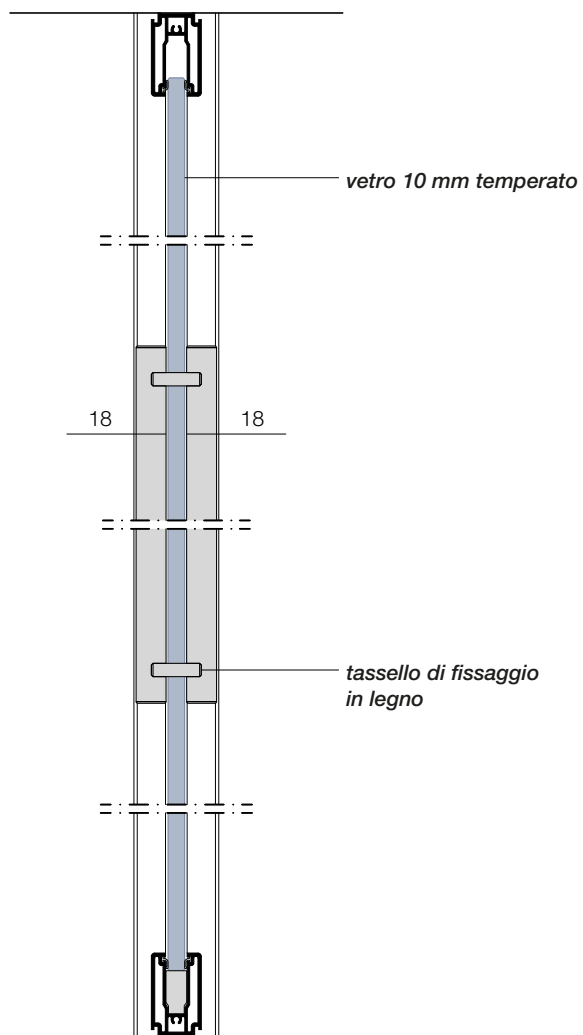

### Parete con pannello intero

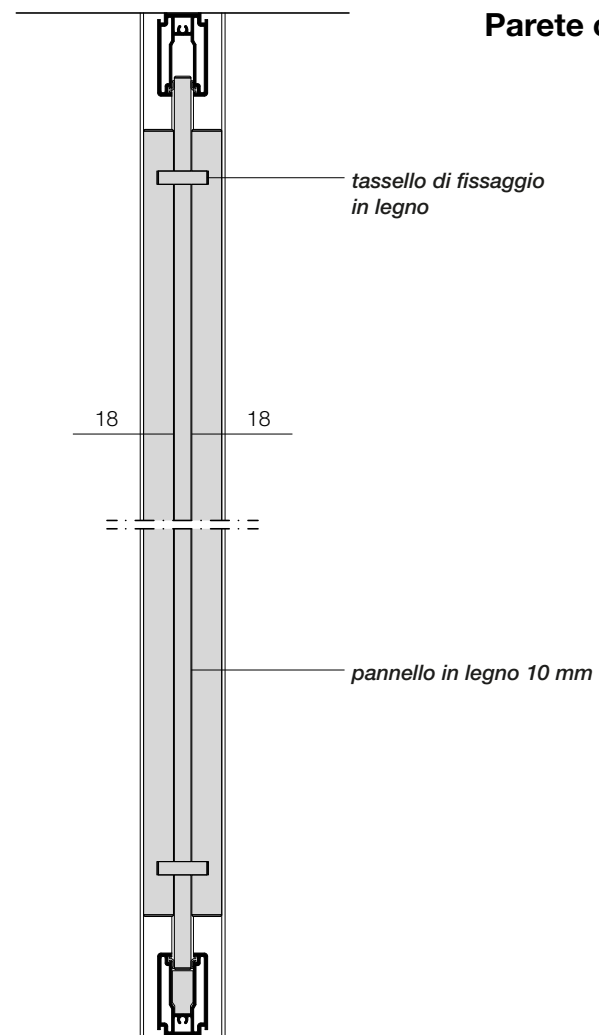

**UNICA® SC1/SC2/SC3**

---

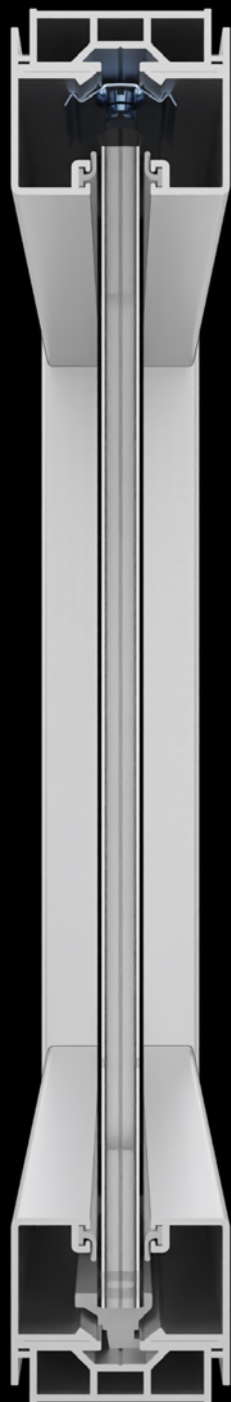

UNICA® SC3/ 5+5

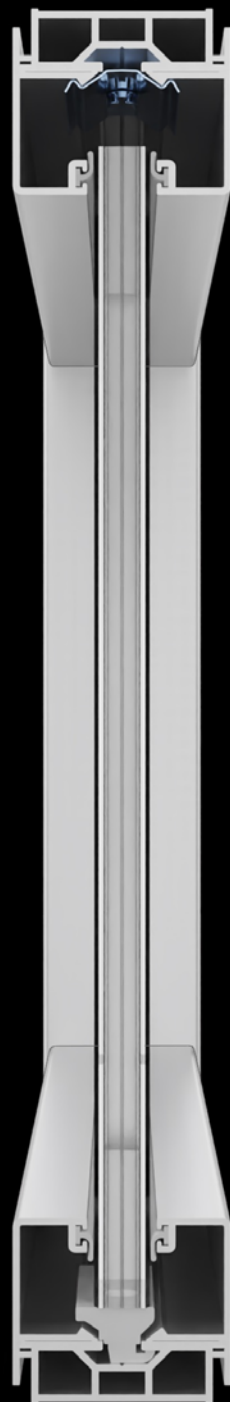

UNICA® SC1/ 6+6

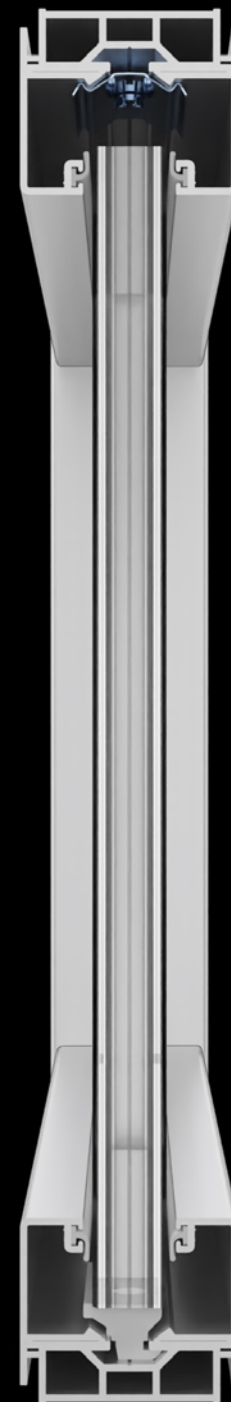

UNICA® SC2/ 8+8

## Plus e Prestazioni acustiche



- 01.** Spessore 51 mm
- 02.** Profilo fermavetro - dimensioni 47 x 40 mm
- 03.** Profili a pavimento, a soffitto, angoli e partenze in estruso di alluminio 6060 UNI 9006/1
- 04.** SC3: vetro singolo centrale - spessore 55.1/55.2 o temperato 10 mm
- 05.** SC1: vetro singolo centrale - spessore 66.1/66.2 o temperato 12 mm
- 06.** SC2: vetro singolo centrale - spessore 88.1/88.2 o temperato 16 mm
- 07.** Pannello cieco autoportante o ancorato al vetro
- 08.** Profili d'angolo fissi e variabili - connessioni 2/3/4 vie
- 09.** Giunzioni verticali tra elementi vetrati in alluminio e policarbonato e biadesivo trasparente
- 10.** Telaio porta cablabile
- 11.** Modulo tecnico ispezionabile
- 12.** 7 versioni di porte battenti - cieche, in vetro temperato e intelaiate
- 13.** 5 versioni di porte scorrevoli esterne - cieche, in vetro temperato e intelaiate

- 01. SC3:** Vetro 55.1 - **32 dB**
- 02. SC3:** Vetro 55 + 0,5 PVB acustico + isolante - **35 dB**
- 03. SC1:** Vetro 66.1 - **36 dB**
- 04. SC1:** Vetro 66.2 + pellicola acustica - **38 dB**
- 05. SC2:** Vetro 88.1 - **37 dB**
- 06. SC2:** Vetro 88.2 + pellicola acustica - **40 dB**



# Partenze

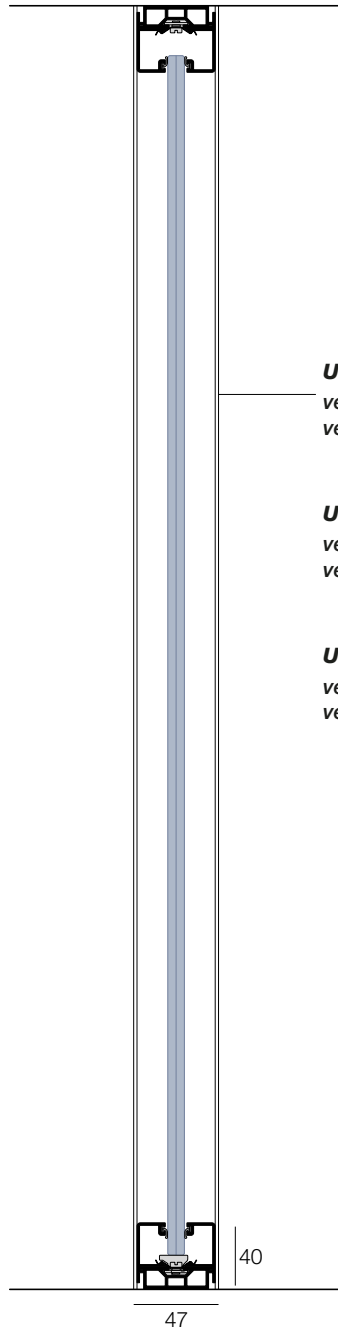

**Unica SC3**  
vetro 55.1/55.2 stratificato  
vetro 10 mm temperato

**Unica SC1**  
vetro 66.1/66.2 stratificato  
vetro 12 mm temperato

**Unica SC2**  
vetro 88.1/88.2 stratificato  
vetro 16 mm temperato

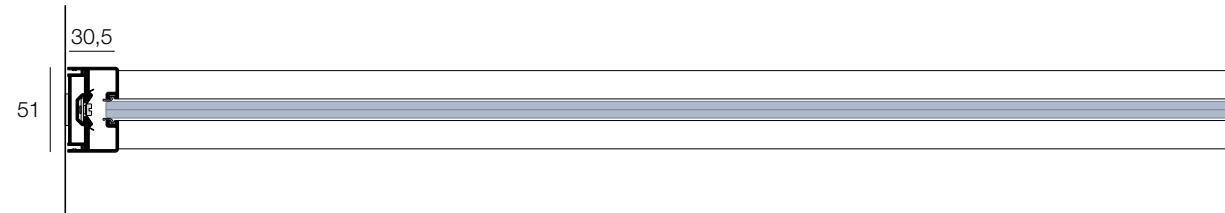

**Partenza fissa da parete**

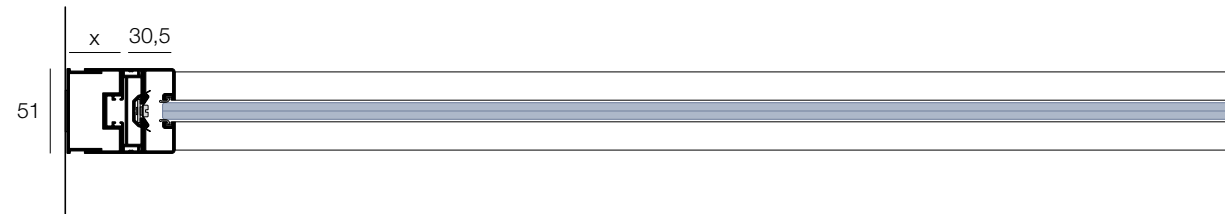

**Partenza telescopica da parete**

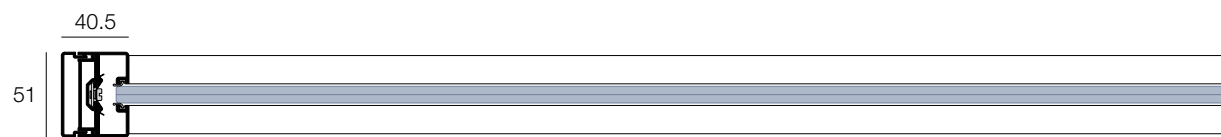

**Profilo terminale**

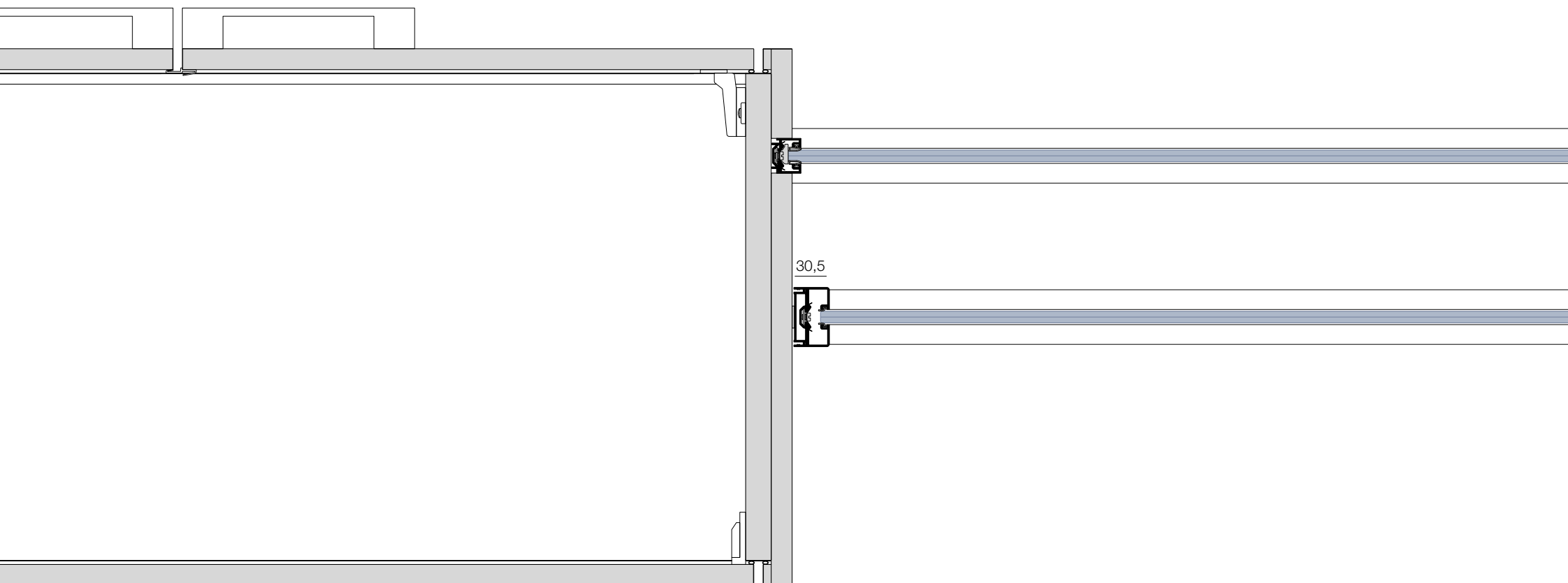

**Partenze da contenitore**



# Connessioni



variabile



**Connessione  
in alluminio**



**Connessione  
in policarbonato**



**Connessione  
con biadesivo tecnico**



**Connessione  
a tre vie  
in alluminio**

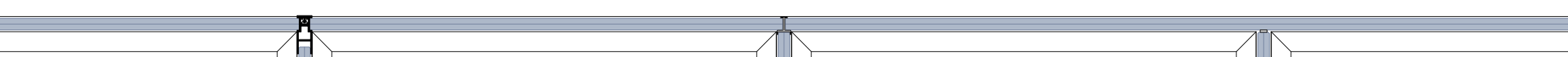

**Connessione  
a tre vie  
in policarbonato**

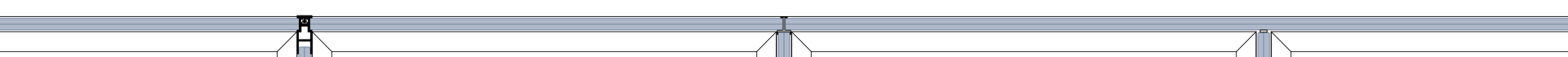

**Connessione  
a tre vie  
con biadesivo tecnico**

# Angoli per Unica SC3



Angolo a 90°  
in policarbonato/alluminio

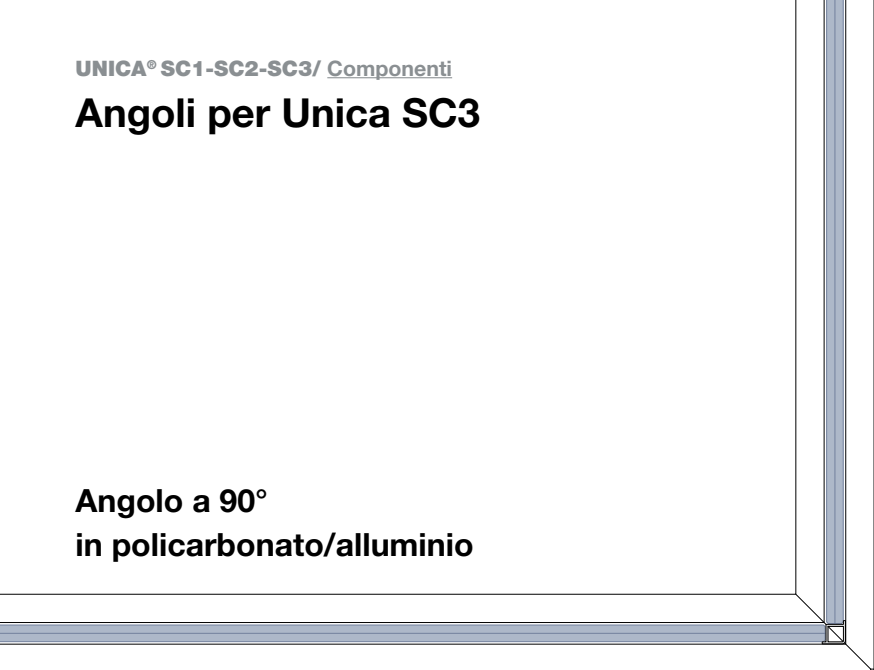

Angolo a 90°  
con biadesivo tecnico

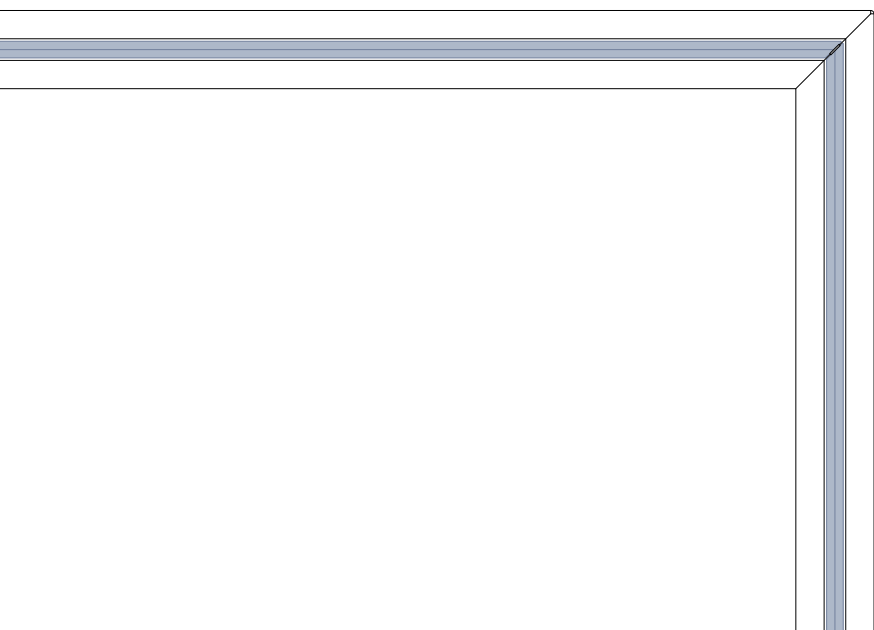

Angolo 2 vie

Angolo variabile

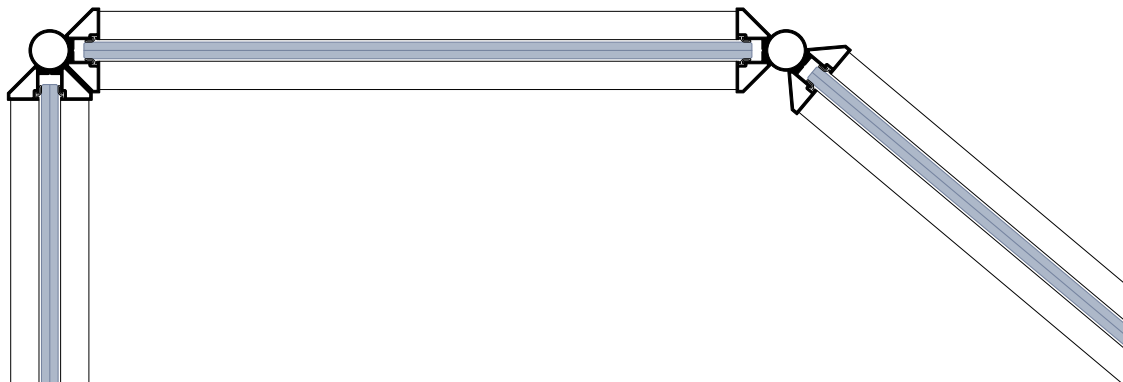

Angolo 3 vie

Angolo 4 vie

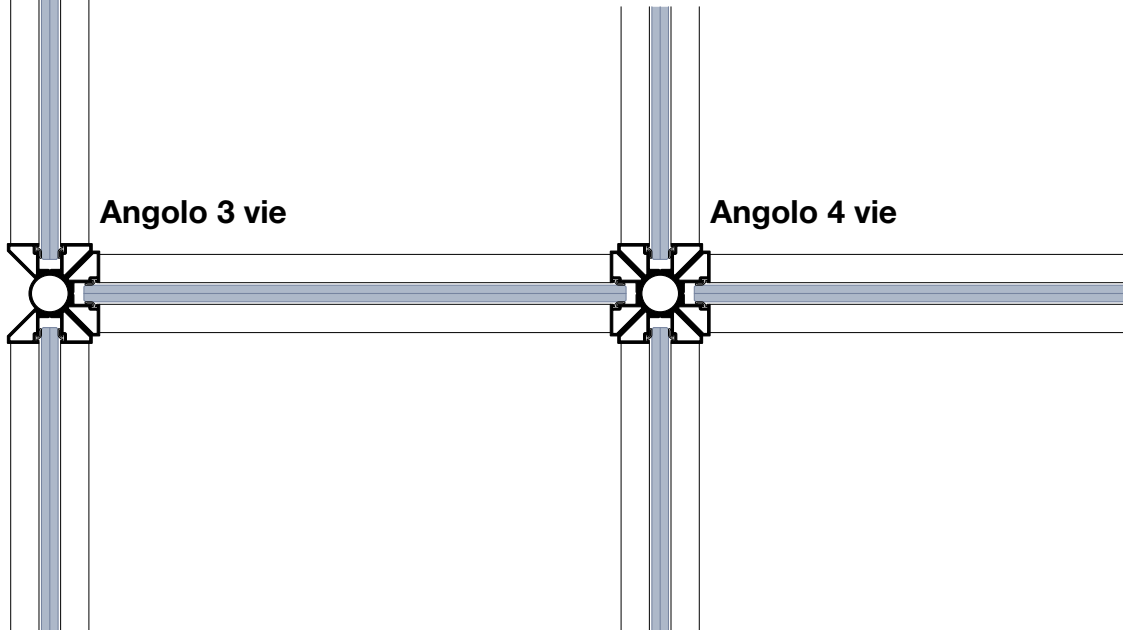

# Angoli per Unica SC1 e SC2



Angolo a 90°  
in policarbonato/alluminio

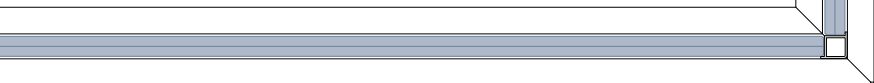

Angolo a 90°  
con biadesivo tecnico

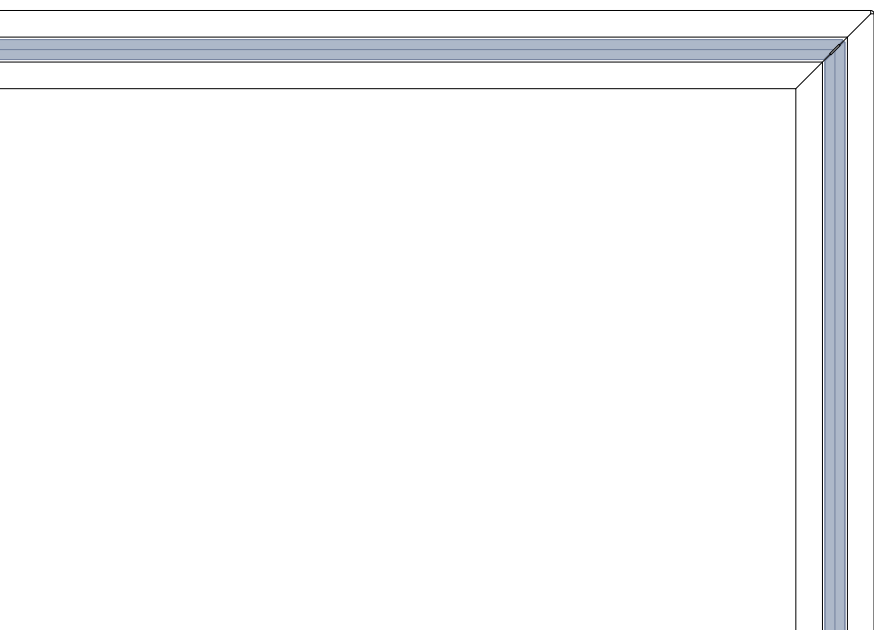

Angolo 2 vie

Angolo variabile

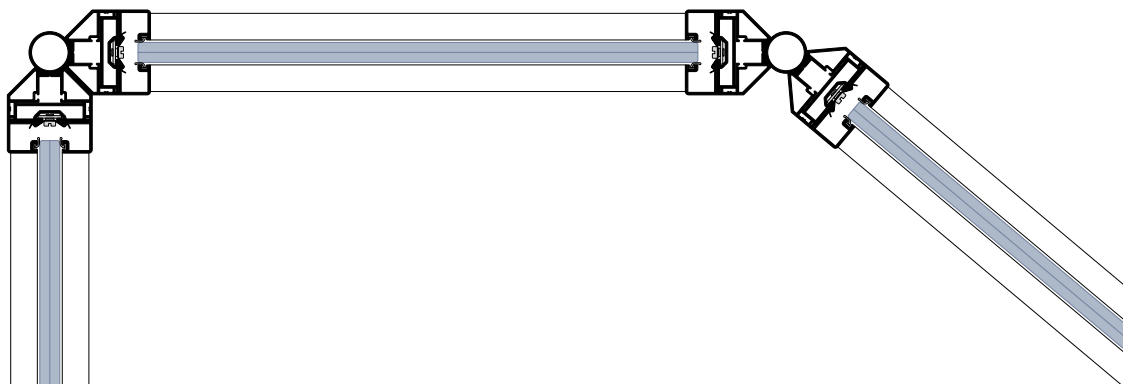

Angolo 3 vie

Angolo 4 vie

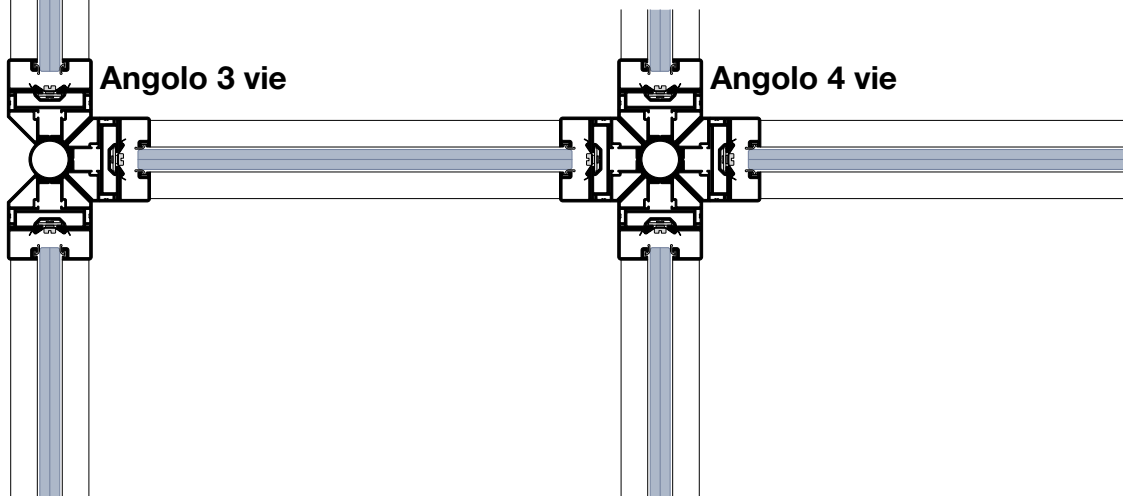

# Cablaggio e modulo tecnico della porta a battente



## Modulo tecnico

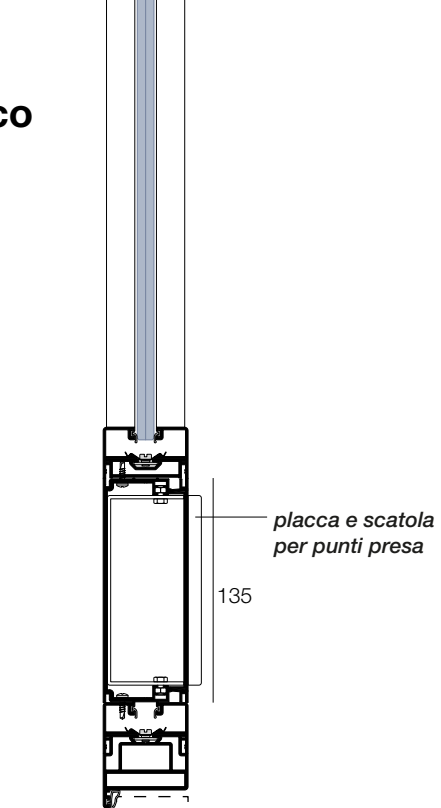

## Soluzione di cablaggio

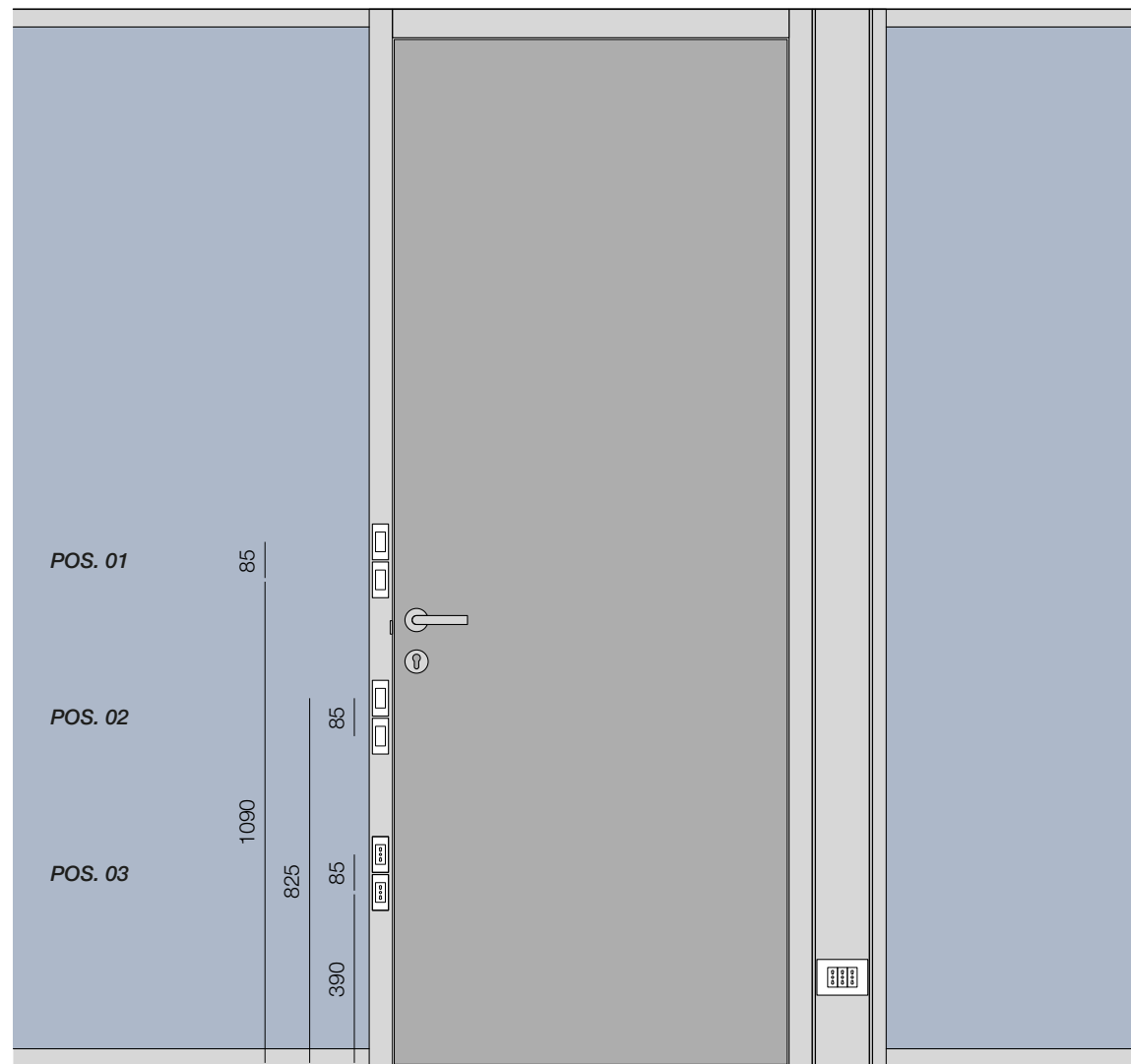
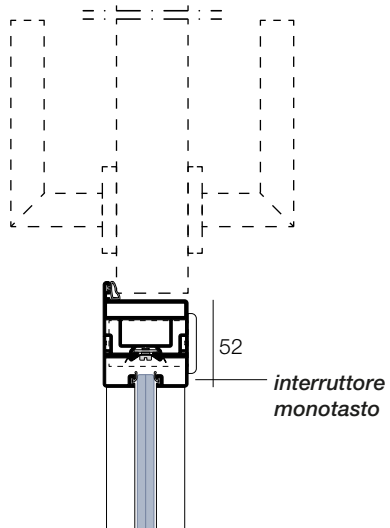

*\*posizioni possibili di interruttori e prese su telaio porta*

# Cablaggio e modulo tecnico della porta scorrevole



## Modulo tecnico

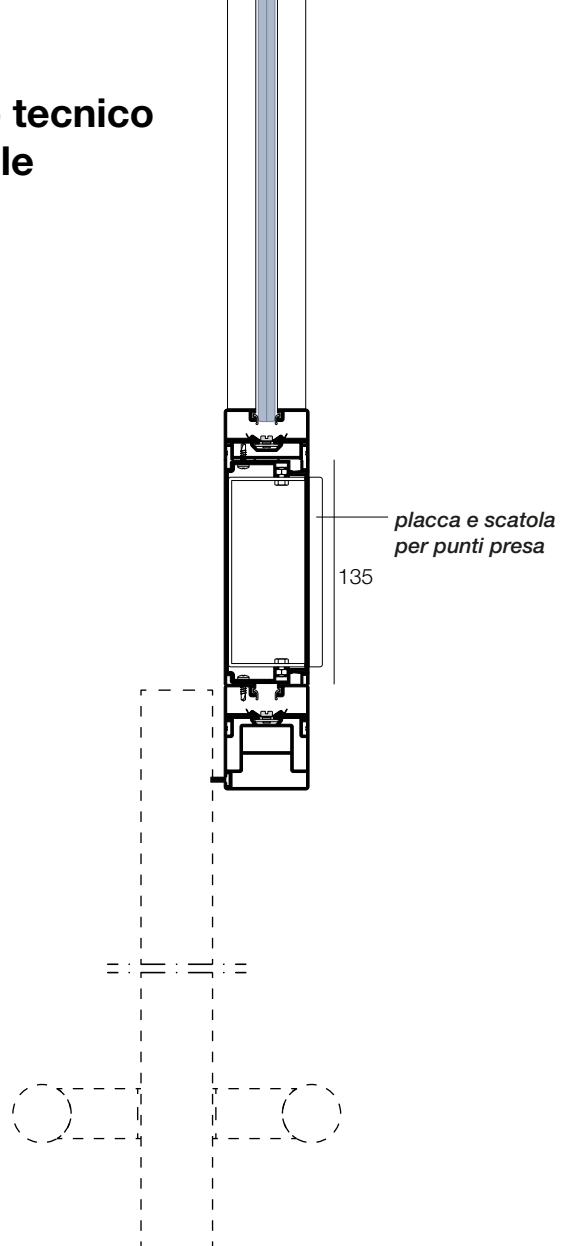

## Soluzione di cablaggio

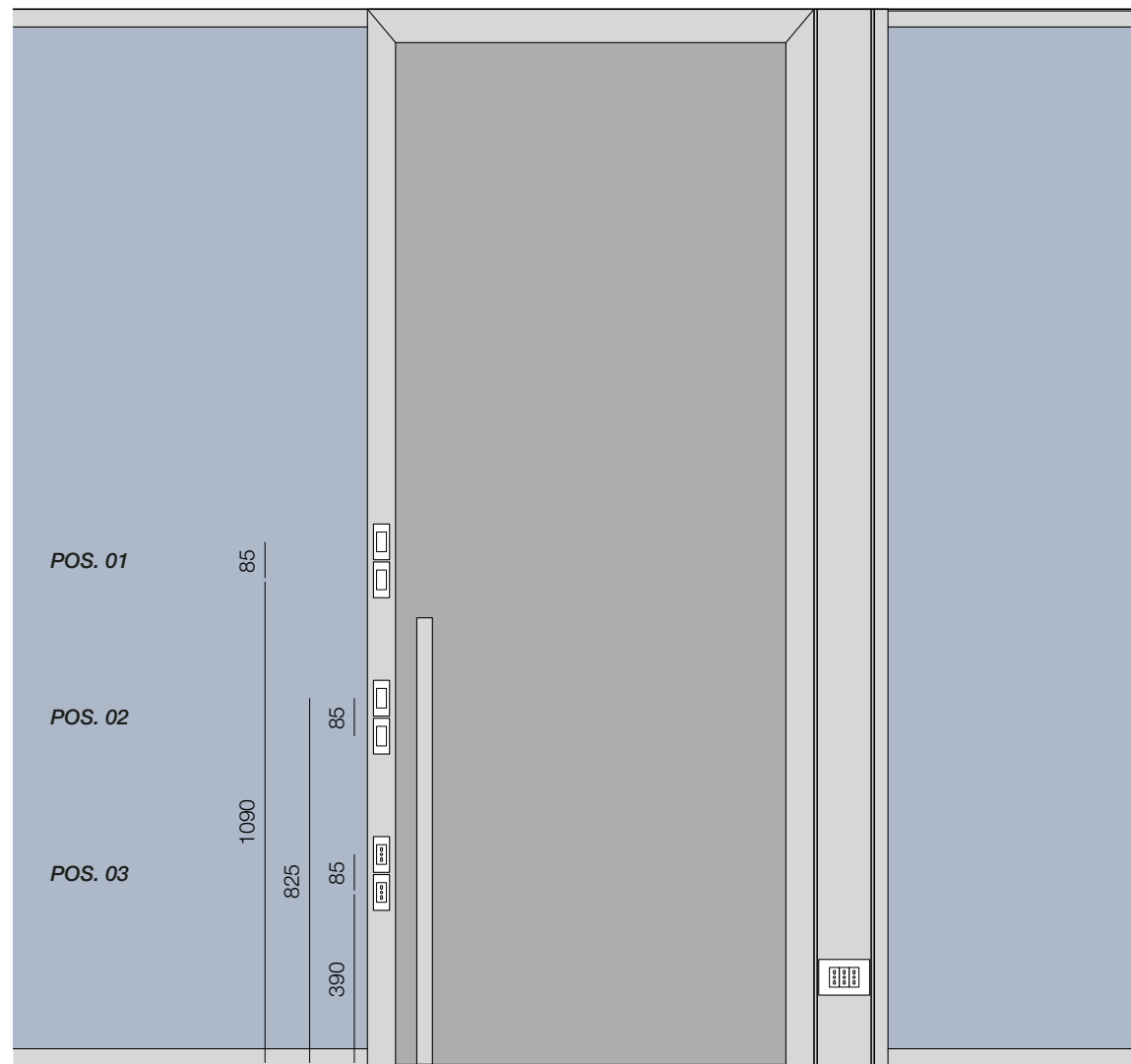
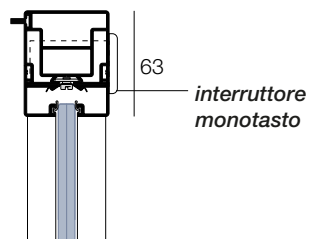

*\*posizioni possibili di interruttori e prese su telaio porta*

# Pannello cieco



## Parete con pannello sospeso

**Unica SC3**  
vetro 10 mm temperato

**Unica SC1**  
vetro 12 mm temperato

**Unica SC2**  
vetro 16 mm temperato

tassello di fissaggio  
in legno

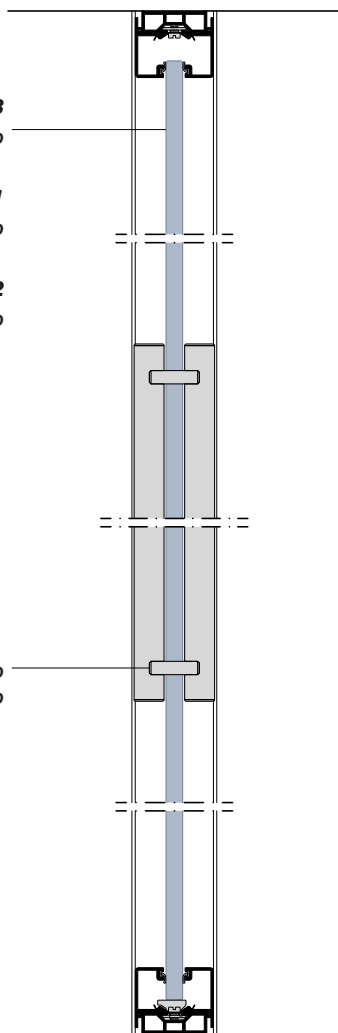

## Parete con pannello intero

tassello di fissaggio  
in legno

**Unica SC3**  
pannello in legno 10 mm

**Unica SC1**  
pannello in legno 12 mm

**Unica SC2**  
pannello in legno 18 mm

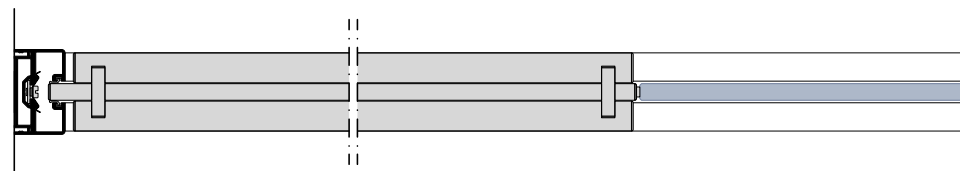
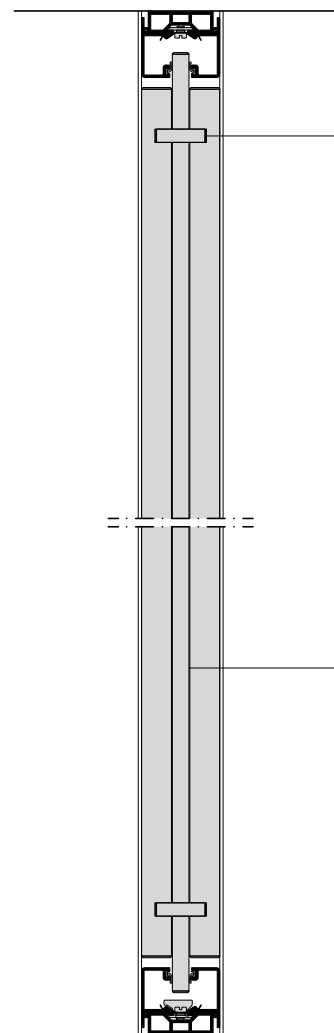

**UNICA® R**

---



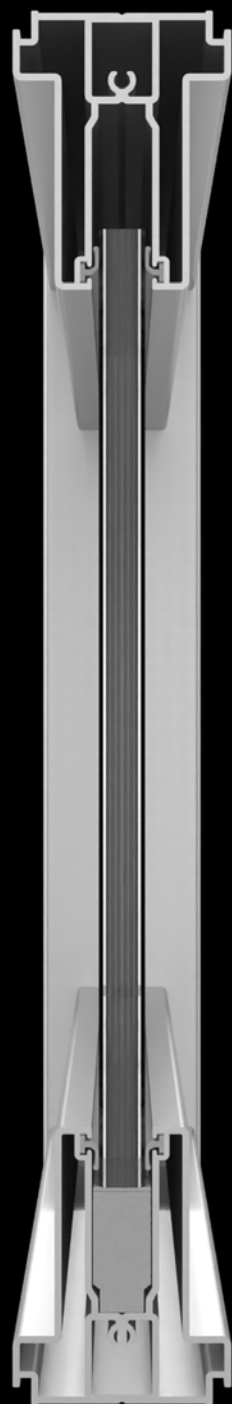



- 01.** Spessore 51 mm
- 02.** Profilo fermavetro - dimensioni 47 x 60 mm
- 03.** Profili a pavimento, a soffitto, angoli e partenze in estruso di alluminio 6060 UNI 9006/1
- 04.** Vetro singolo centrale - spessore 55.1/55.2 o temperato 10 mm
- 05.** Pannello cieco in vari formati autoportante o ancorato al vetro
- 06.** Profili d'angolo fissi e variabili - connessioni 2/3/4 vie
- 07.** Giunzioni verticali tra elementi vetrati in alluminio, policarbonato e biadesivo trasparente
- 08.** Telaio porta cablabile
- 09.** Modulo tecnico ispezionabile
- 10.** 7 versioni di porte battenti - cieche, in vetro temperato e intelaiate
- 11.** 5 versioni di porte scorrevoli esterne - cieche, in vetro temperato e intelaiate

**01.** Vetro 55.1 - **32 dB**

**02.** Vetro 55 + 0,5 PVB acustico + isolante - **35 dB**



# Partenze

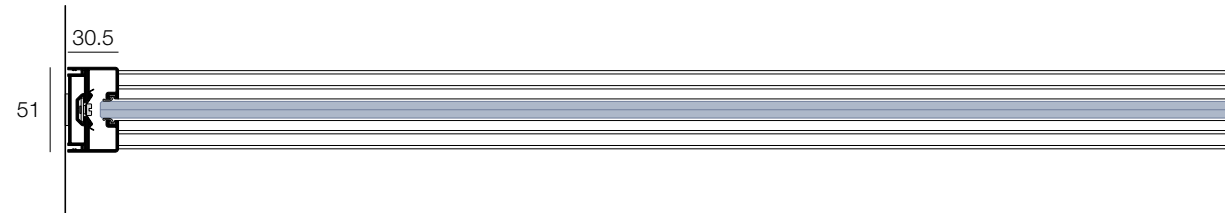
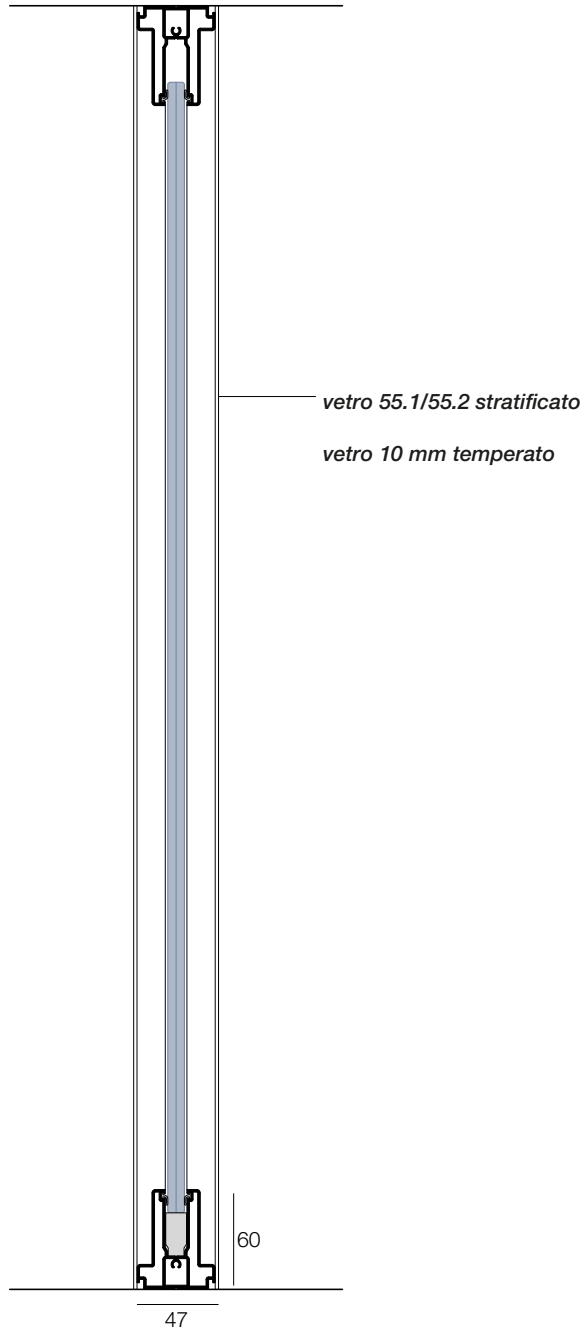

**Partenza fissa da parete**

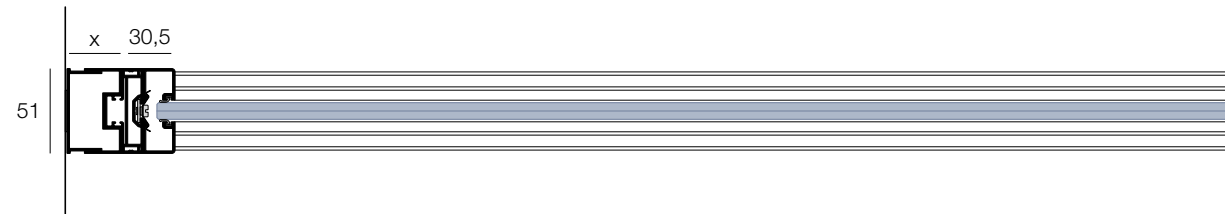

**Partenza telescopica da parete**



**Profilo terminale**

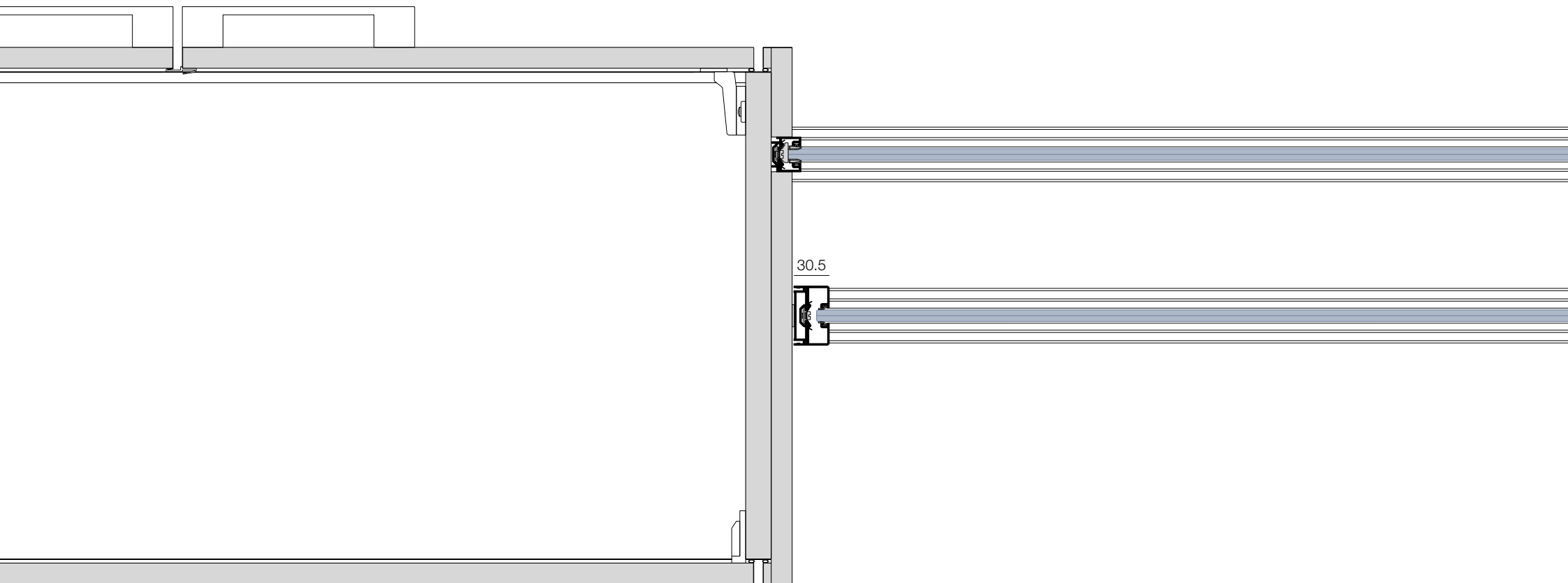

**Partenze da contenitore**



variabile



**Connessione  
in alluminio**



**Connessione  
in policarbonato**



**Connessione  
con biadesivo tecnico**



**Connessione  
a tre vie  
in alluminio**



**Connessione  
a tre vie  
in policarbonato**



**Connessione  
a tre vie  
con biadesivo tecnico**

# Angoli



Angolo a 90°  
in policarbonato/alluminio

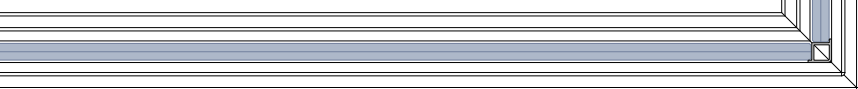

Angolo a 90°  
con biadesivo tecnico



Angolo 2 vie

Angolo variabile

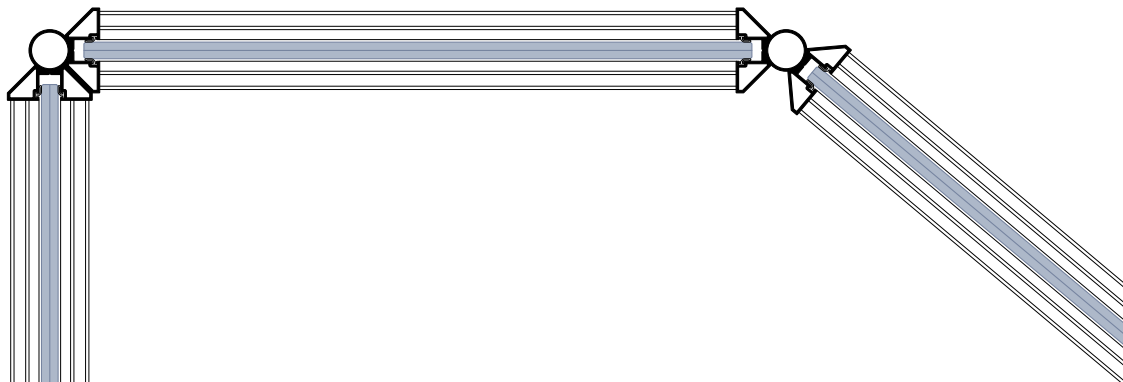

Angolo 3 vie

Angolo 4 vie

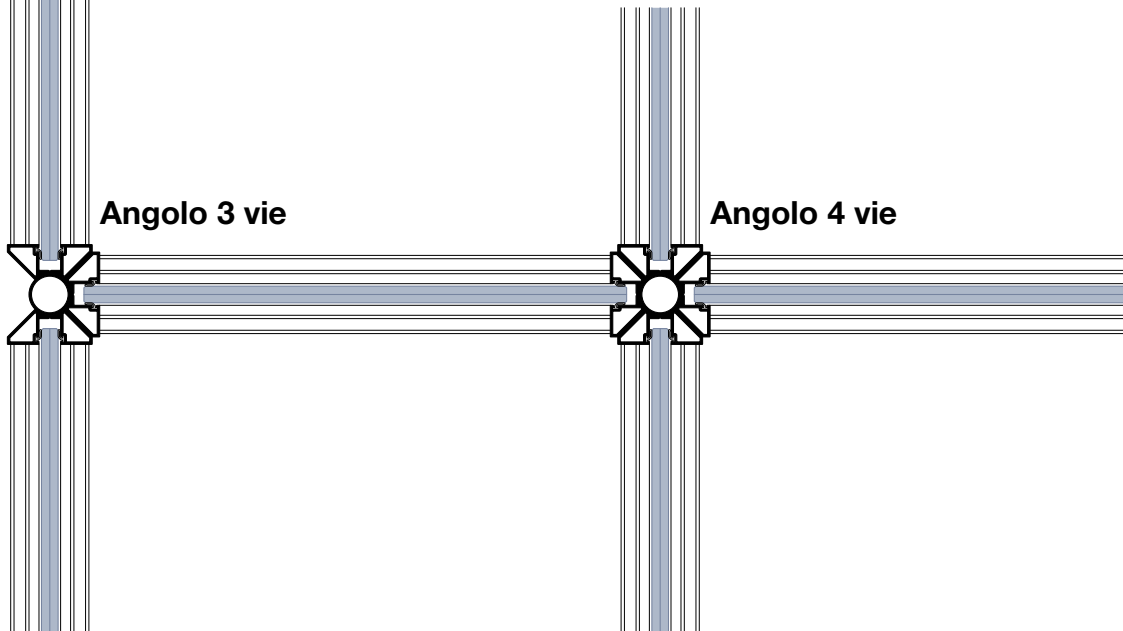



# Cablaggio e modulo tecnico della porta a battente



## Modulo tecnico

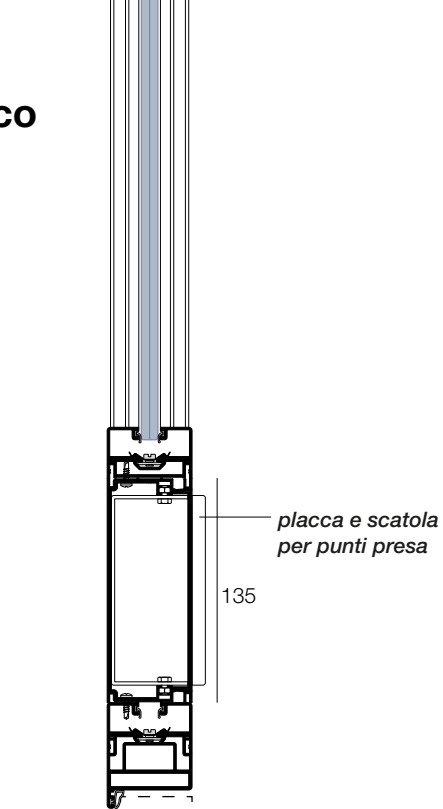

## Soluzione di cablaggio

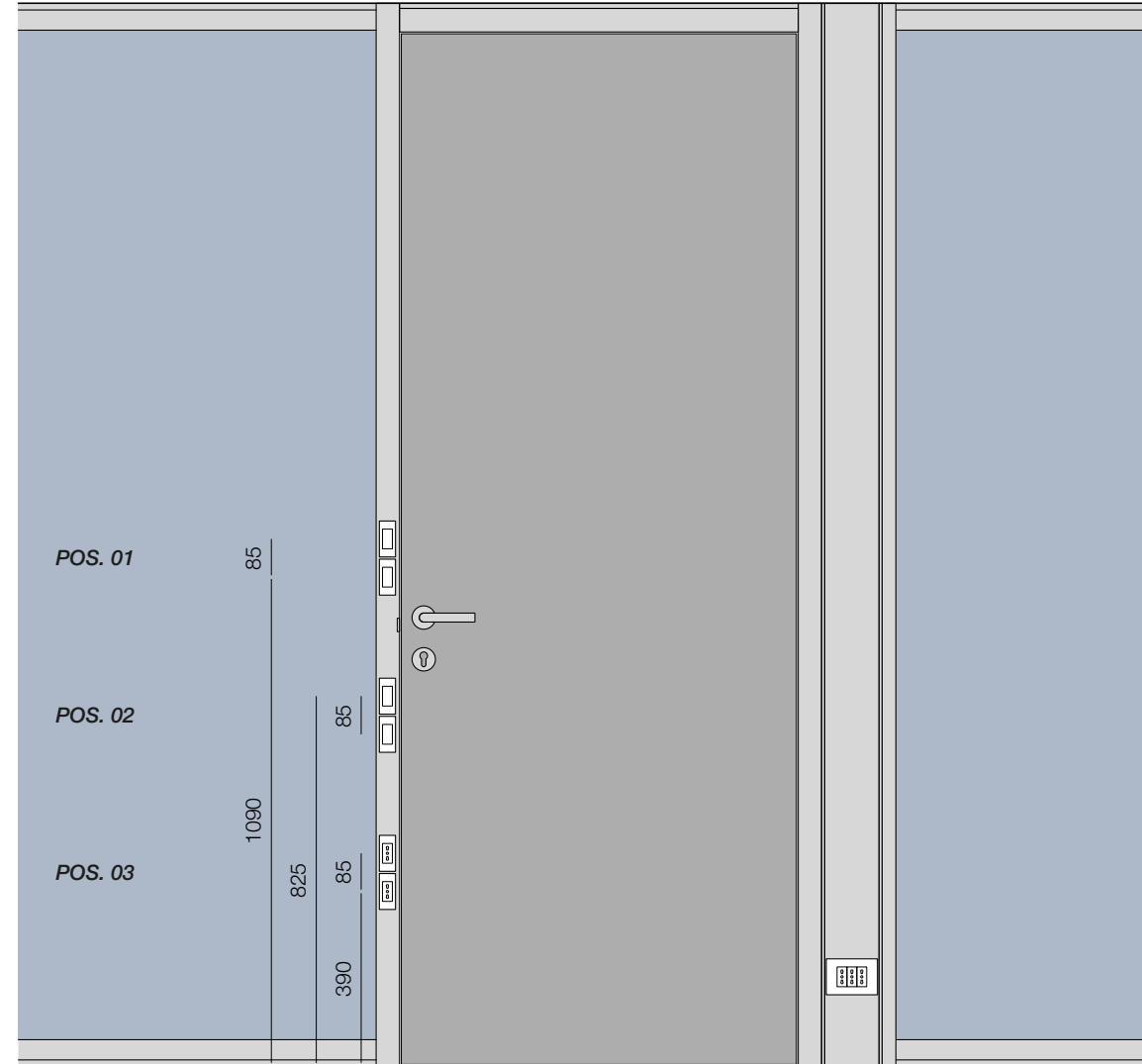
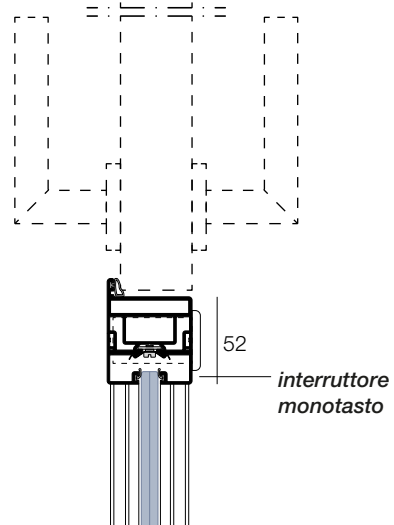

\*posizioni possibili di interruttori e prese su telaio porta

# Cablaggio e modulo tecnico della porta scorrevole



## Modulo tecnico

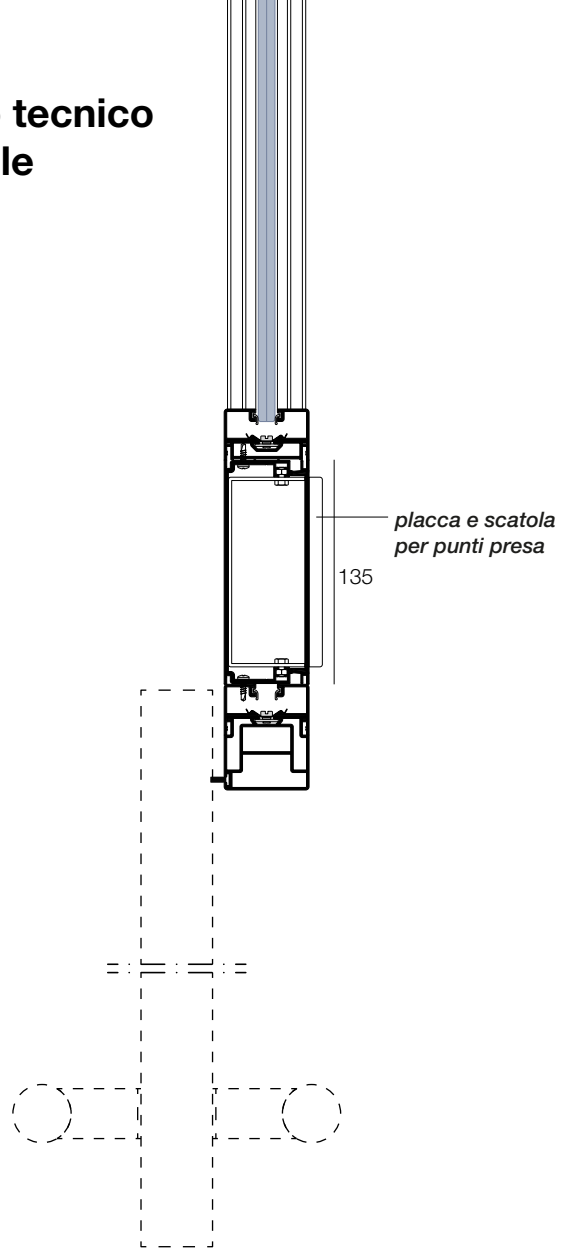

## Soluzione di cablaggio

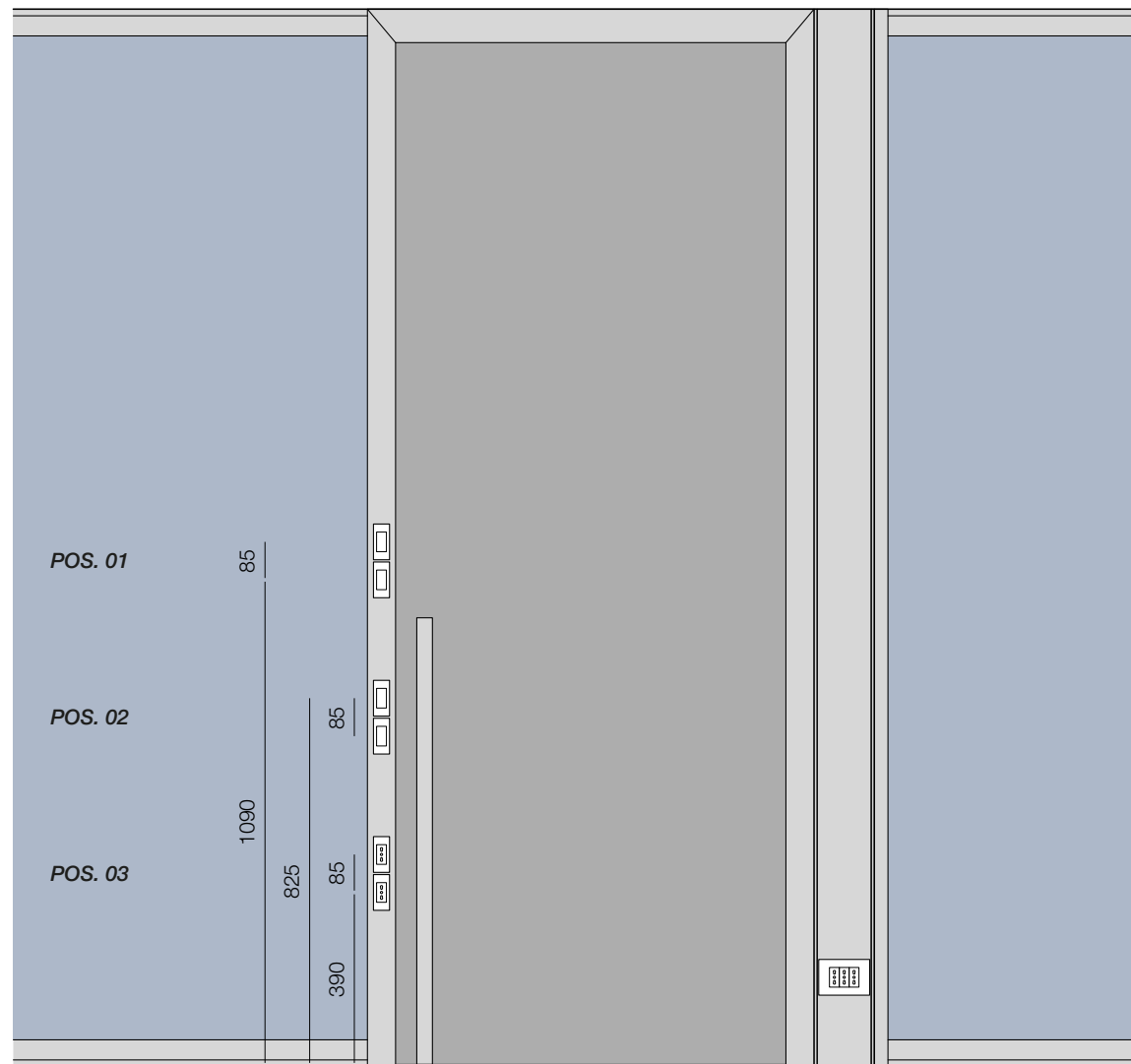
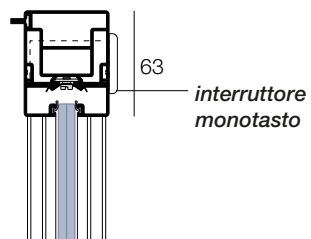

\*posizioni possibili di interruttori e prese su telaio porta

# Pannello cieco



### Parete con pannello sospeso

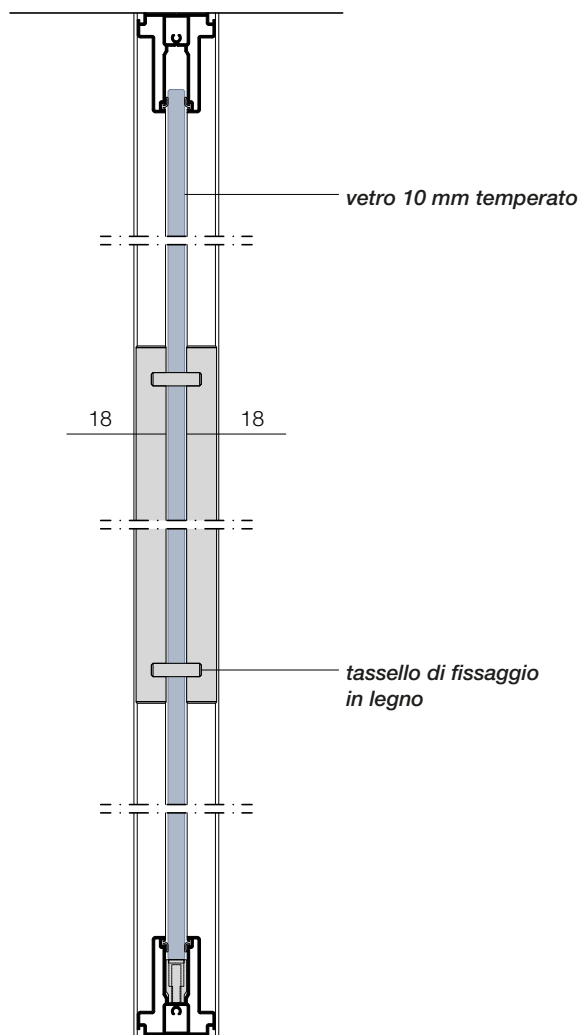

### Parete con pannello intero

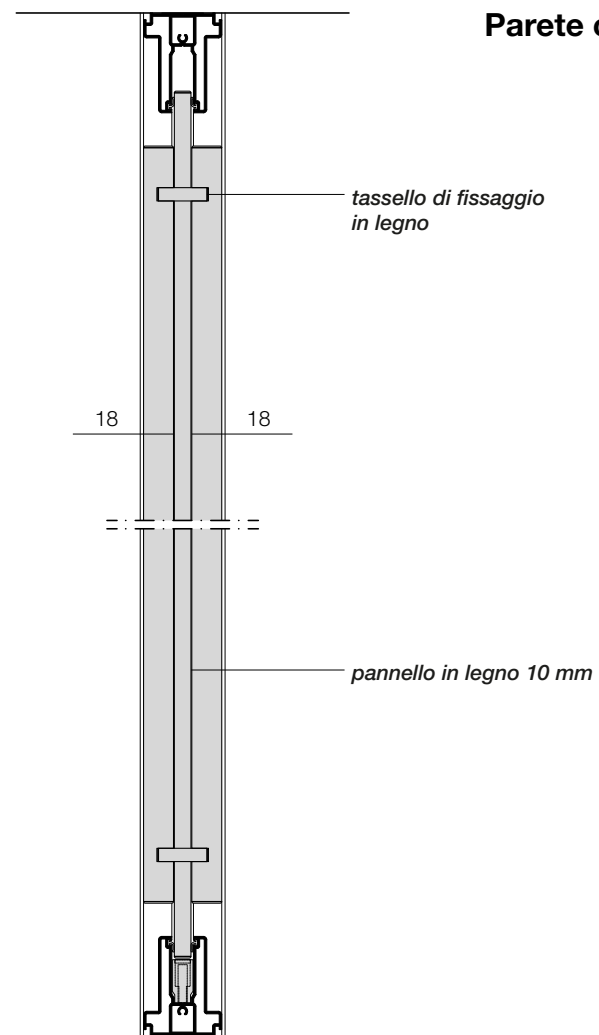

**UNICA<sup>®</sup> D**

---

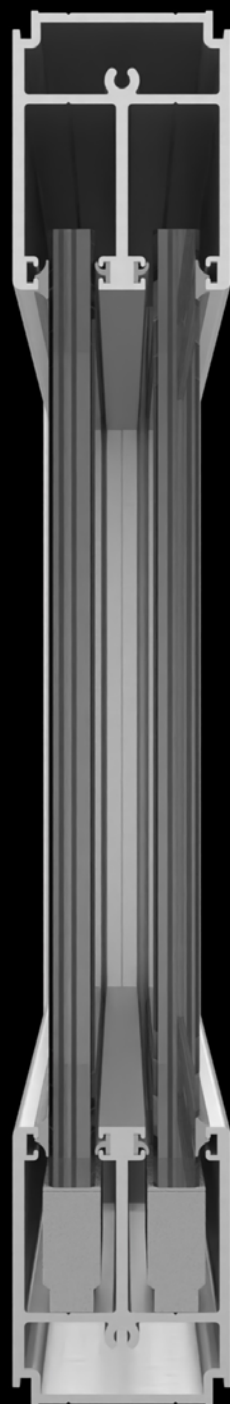



- 01.** Spessore 51 mm
- 02.** Profilo fermavetro - dimensioni 47 x 60 mm
- 03.** Profili a pavimento, a soffitto, angoli e partenze in estruso di alluminio 6060 UNI 9006/1
- 04.** Vetro doppio - spessore 55.1/55.2 o temperato 10 mm
- 05.** Profili d'angolo fissi e variabili - connessioni 2/3/4 vie
- 06.** Giunzioni verticali tra elementi vetrati in alluminio, policarbonato e biadesivo trasparente
- 07.** Telaio porta cablabile
- 08.** Modulo tecnico ispezionabile
- 09.** 7 versioni di porte battenti - cieche, in vetro temperato e intelaiate
- 10.** 5 versioni di porte scorrevoli esterne - cieche, in vetro temperato e intelaiate

**01.** Vetro 55.1 - **37 dB**

**02.** Vetro 55.2 + pellicola acustica - **39 dB**

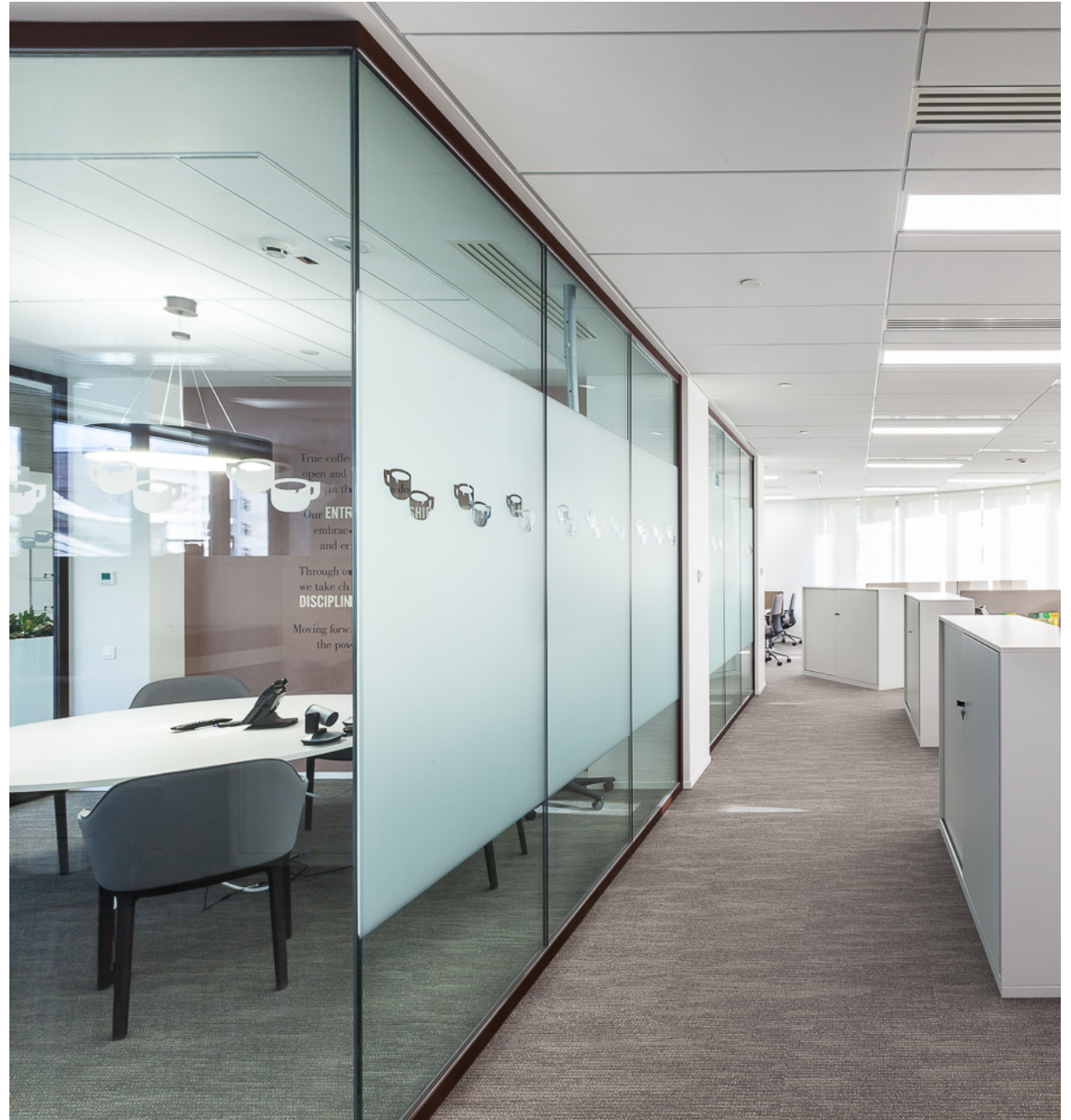

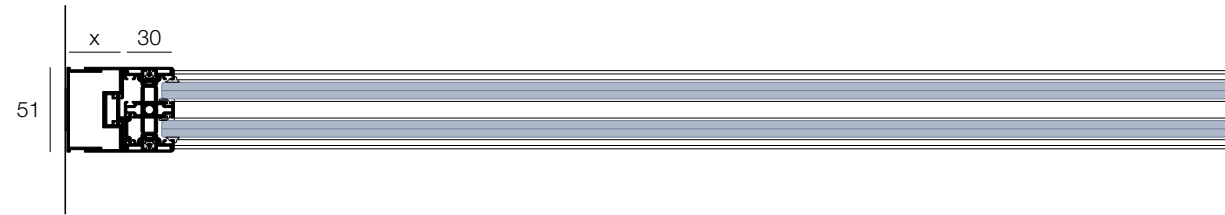
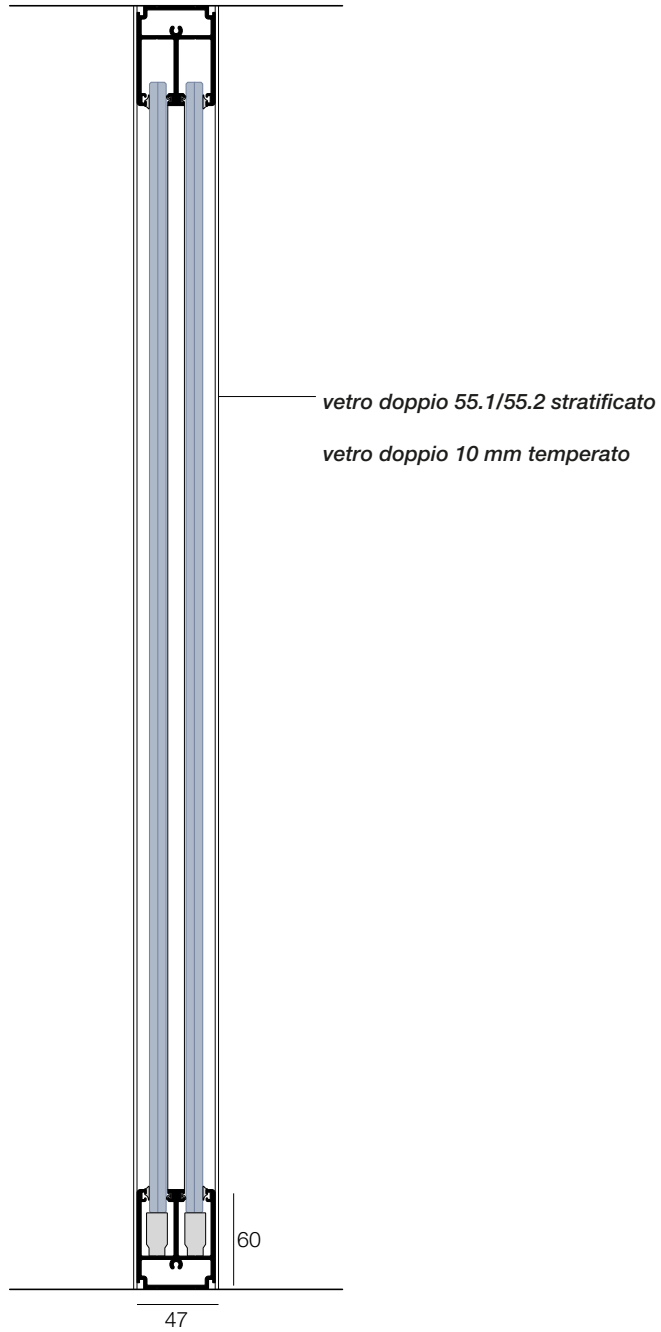

Partenza telescopica da parete





Profilo terminale

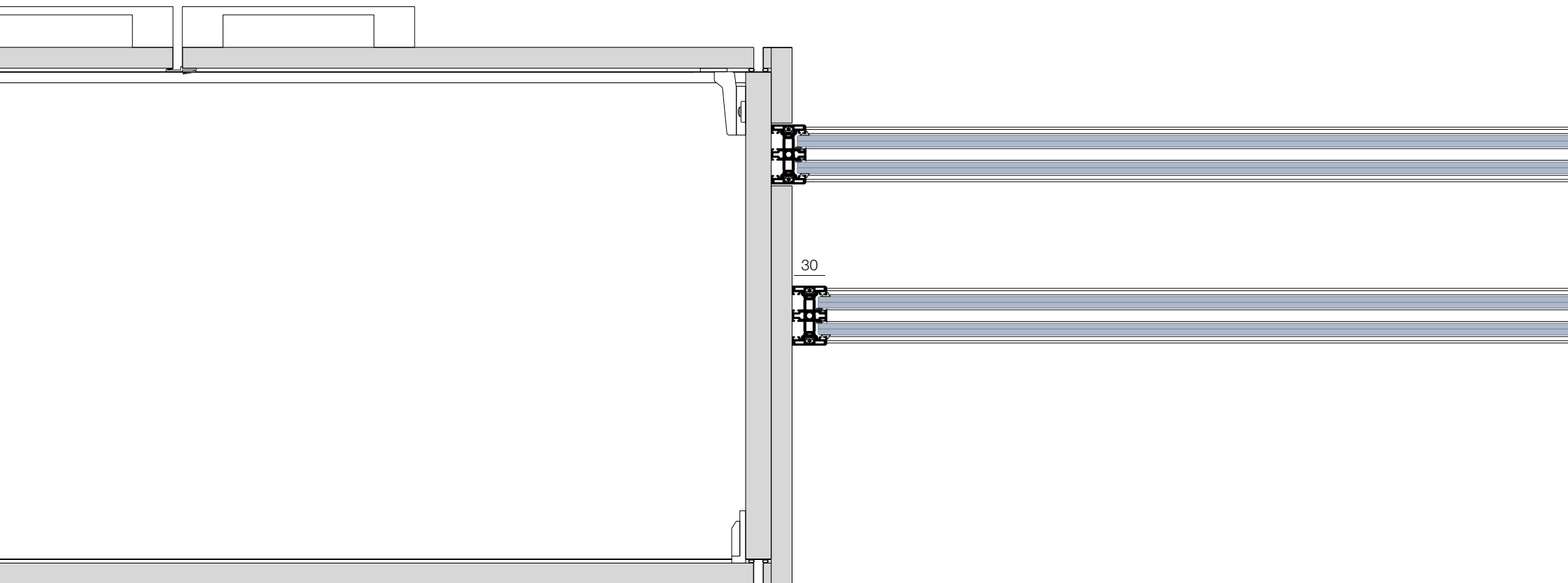

Partenze da contenitore



**Connessione  
con montante apribile**

variabile

**Connessione  
in alluminio**

**Connessione  
in policarbonato**

**Connessione  
con biadesivo tecnico**

**Connessione  
a tre vie  
con biadesivo tecnico**

# Angoli



Angolo a 90°  
in policarbonato/alluminio

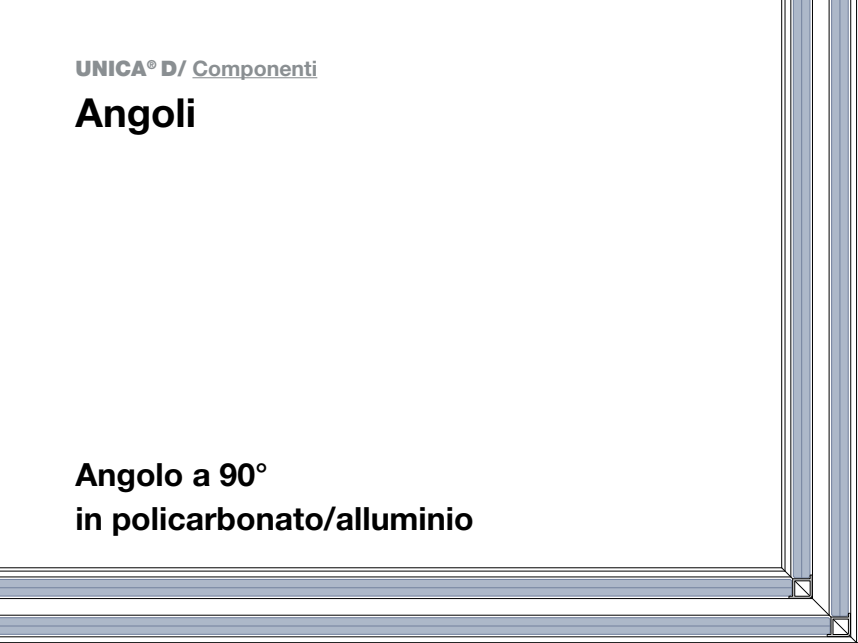

Angolo a 90°  
con biadesivo tecnico



Angolo 2 vie

Angolo variabile

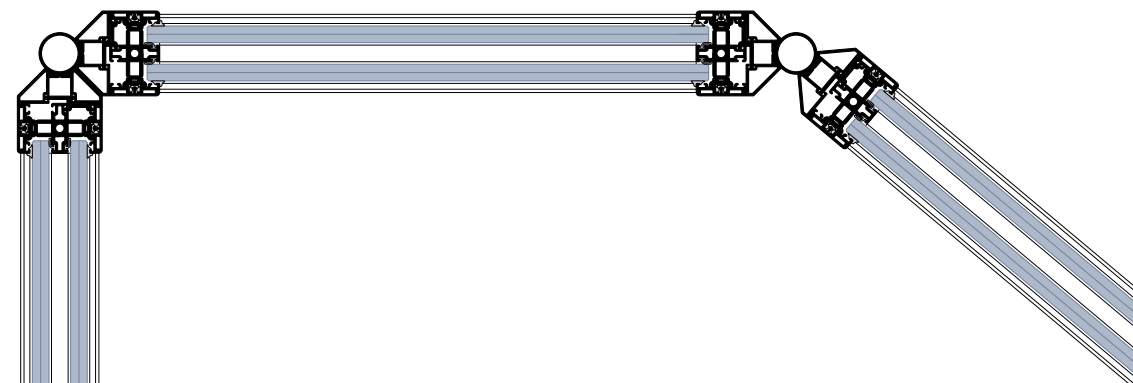

Angolo 3 vie

Angolo 4 vie

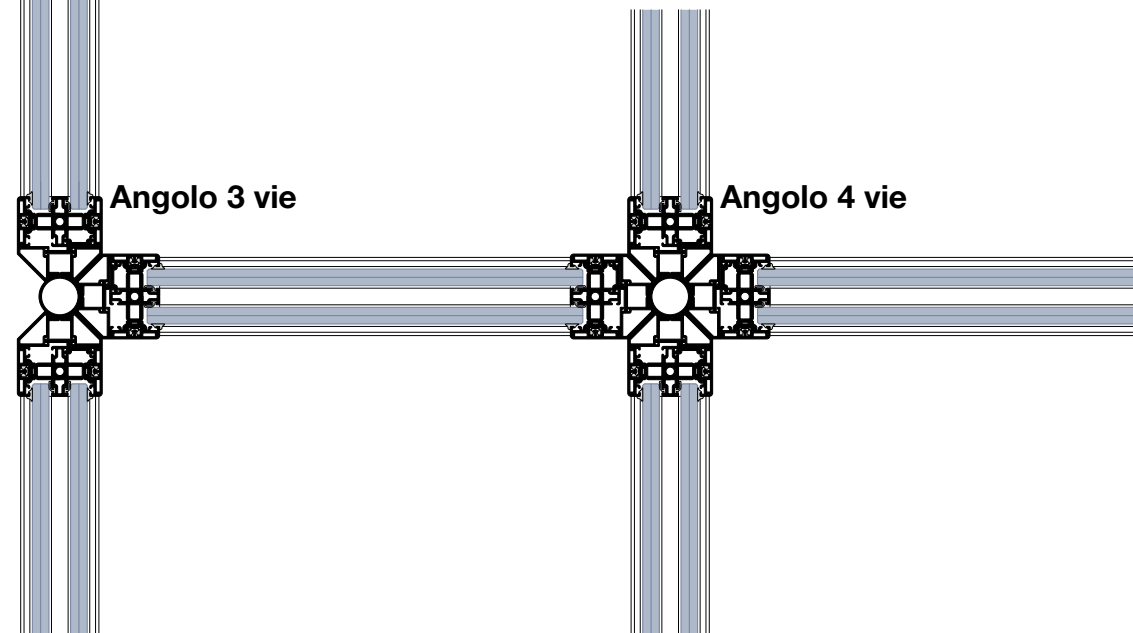

# Cablaggio e modulo tecnico della porta a battente



## Modulo tecnico

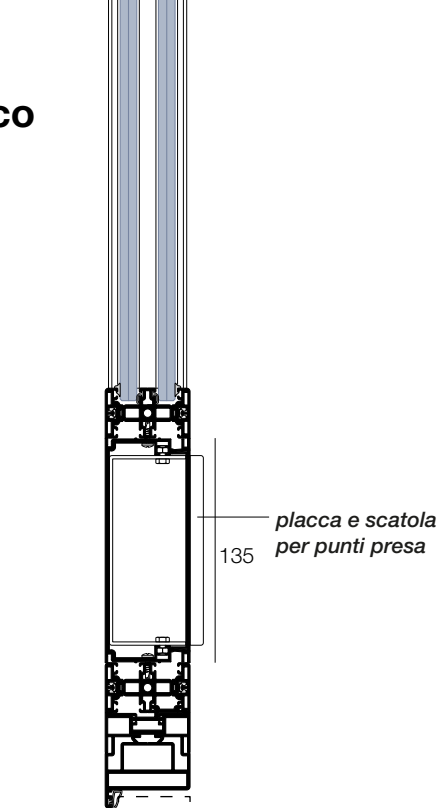

## Soluzione di cablaggio

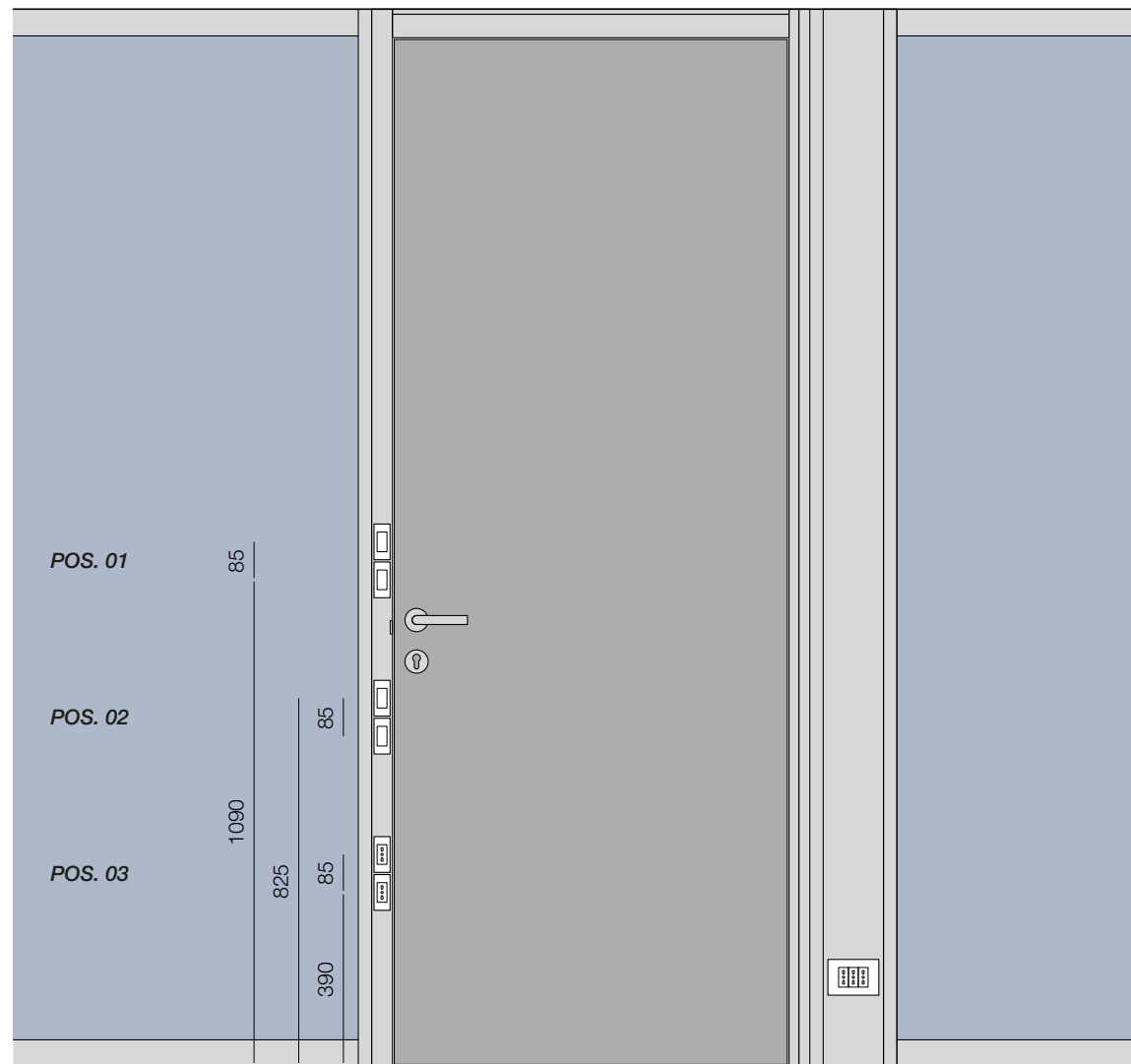
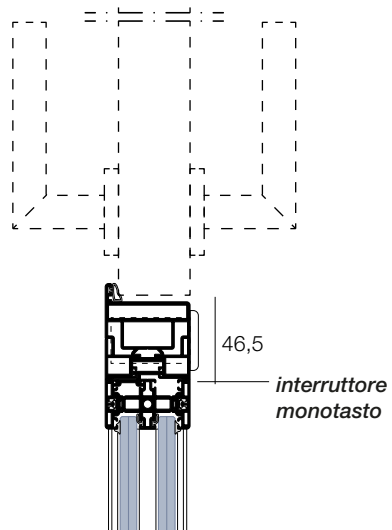

\*posizioni possibili di interruttori e prese su telaio porta

# Cablaggio e modulo tecnico della porta scorrevole



## Modulo tecnico

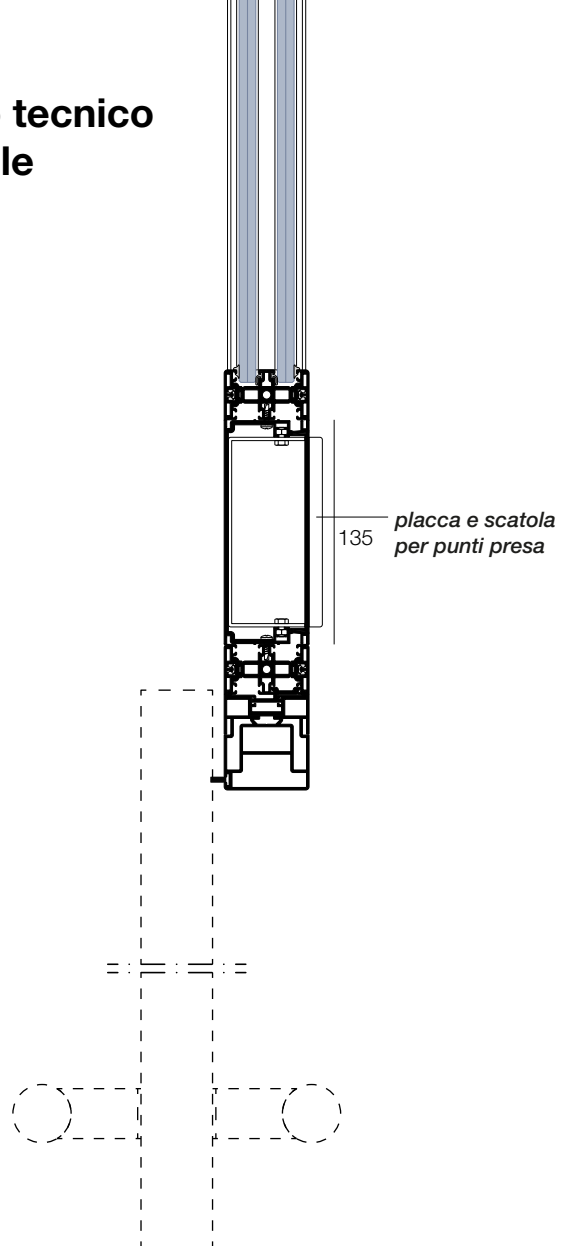

## Soluzione di cablaggio

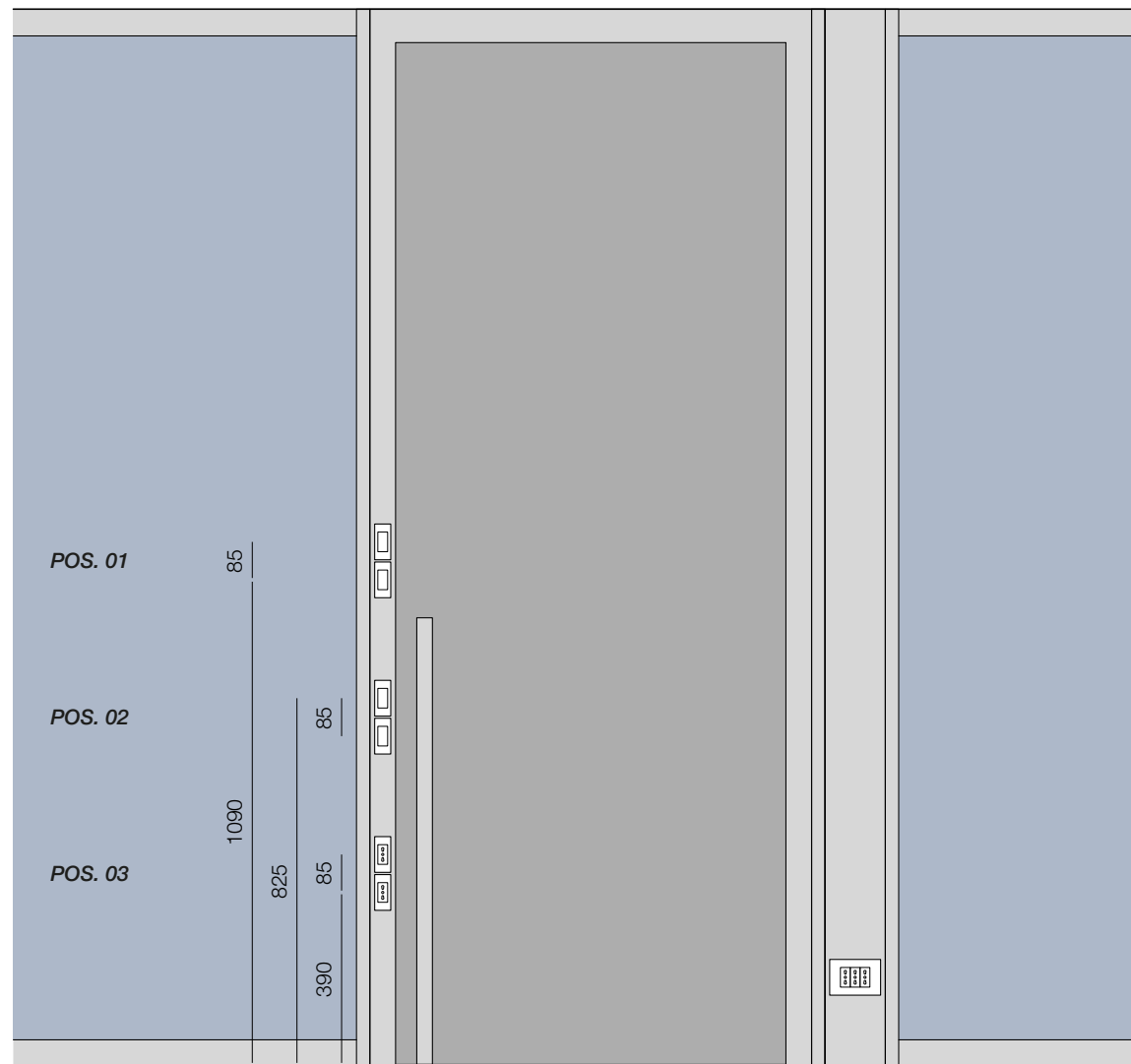
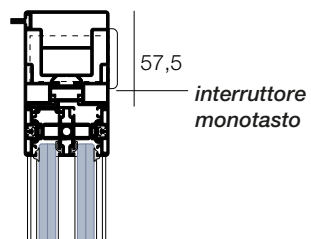

\*posizioni possibili di interruttori e prese su telaio porta

**UNICA®**

Porte e maniglie

---

# TELAI PORTE BATTENTI



Telaio porta su **Unica Slim**

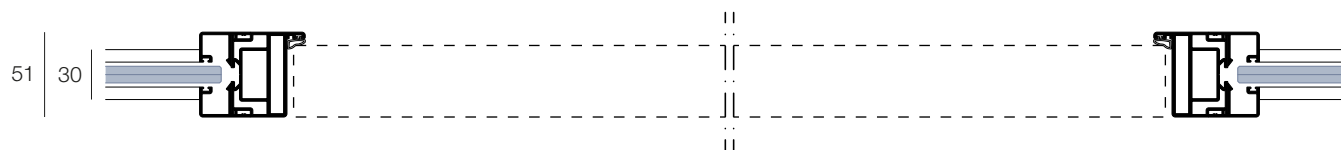

Telaio porta su **Unica U**

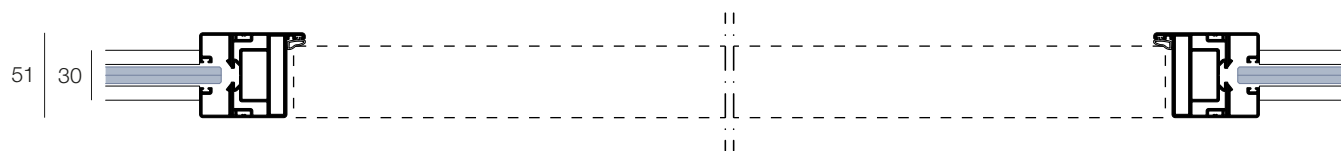

Telaio porta su **Unica SC**

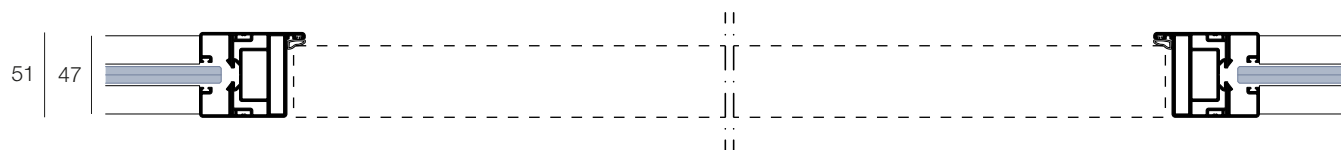

Telaio porta su **Unica R**

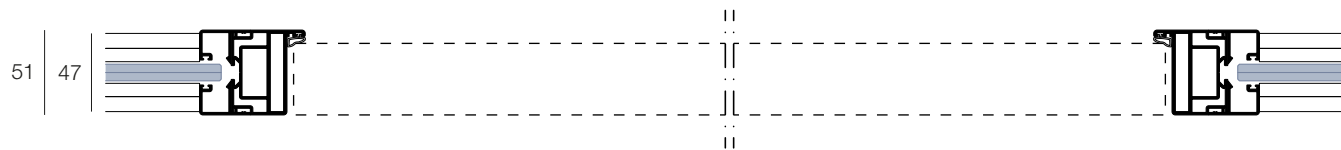

Telaio porta su **Unica D**

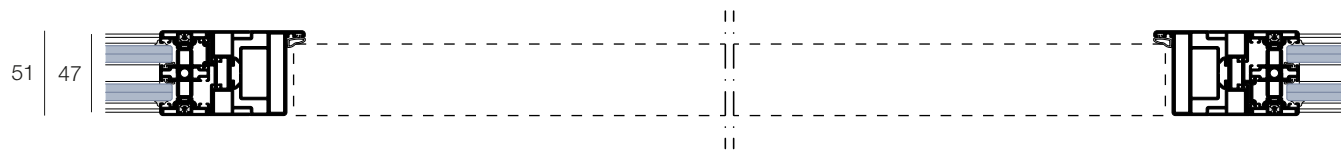

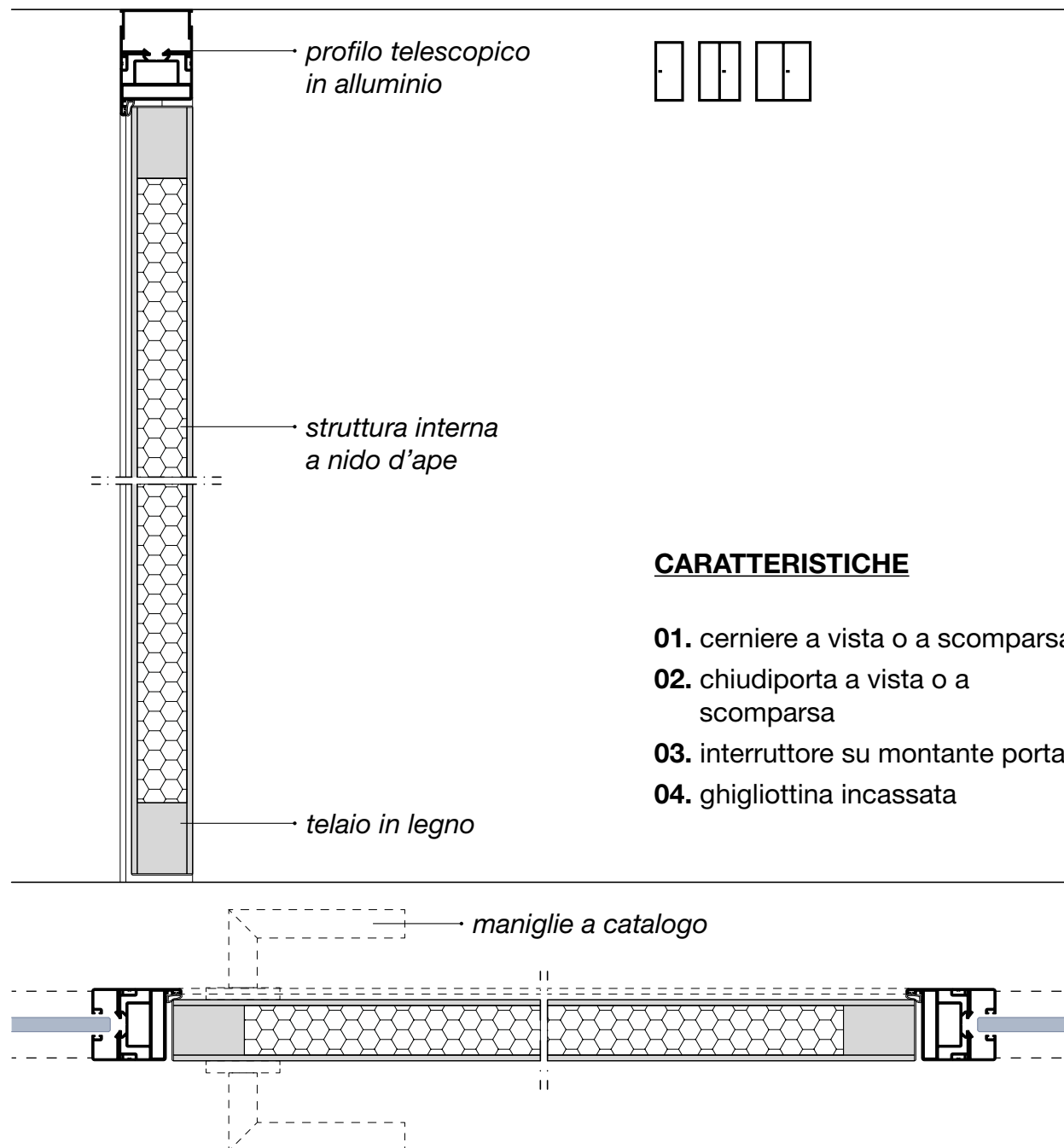



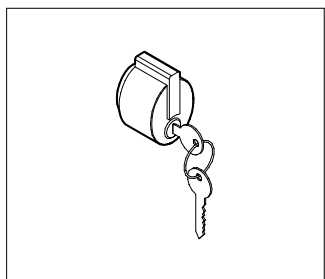

**ML1**

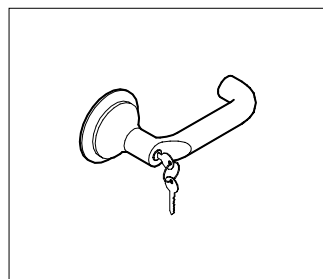

**ML4**

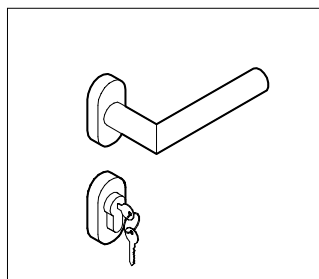

**ML5**

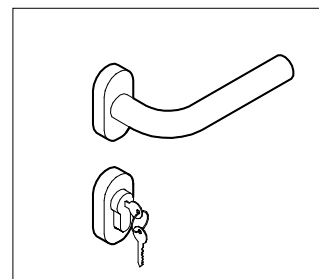

**ML6**

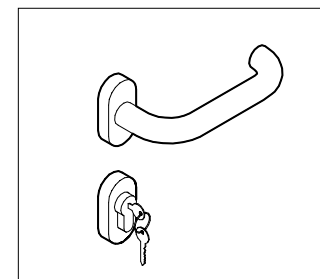

**ML7**

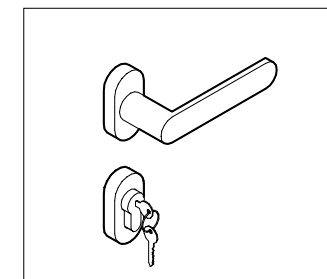

**ML8**

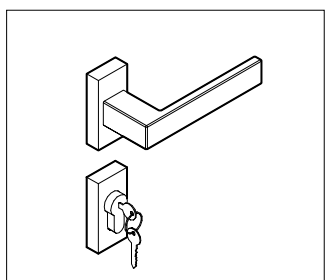

**ML9**

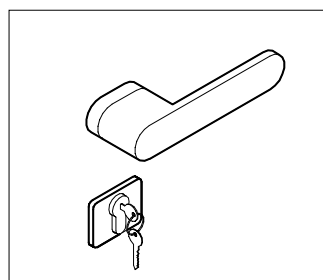

**ML10**

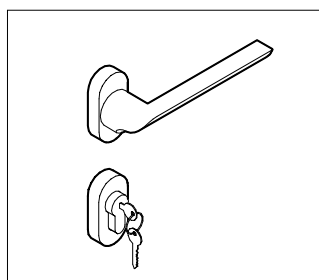

**ML11**

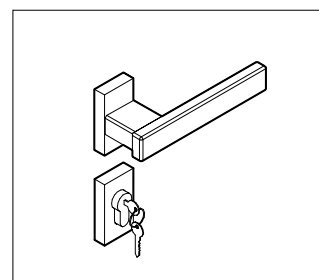

**MLQ**

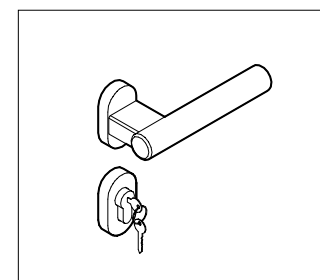

**MLT**

# ANTA VETRO TEMPERATO\_CERNIERE A VISTA sp. 10 mm

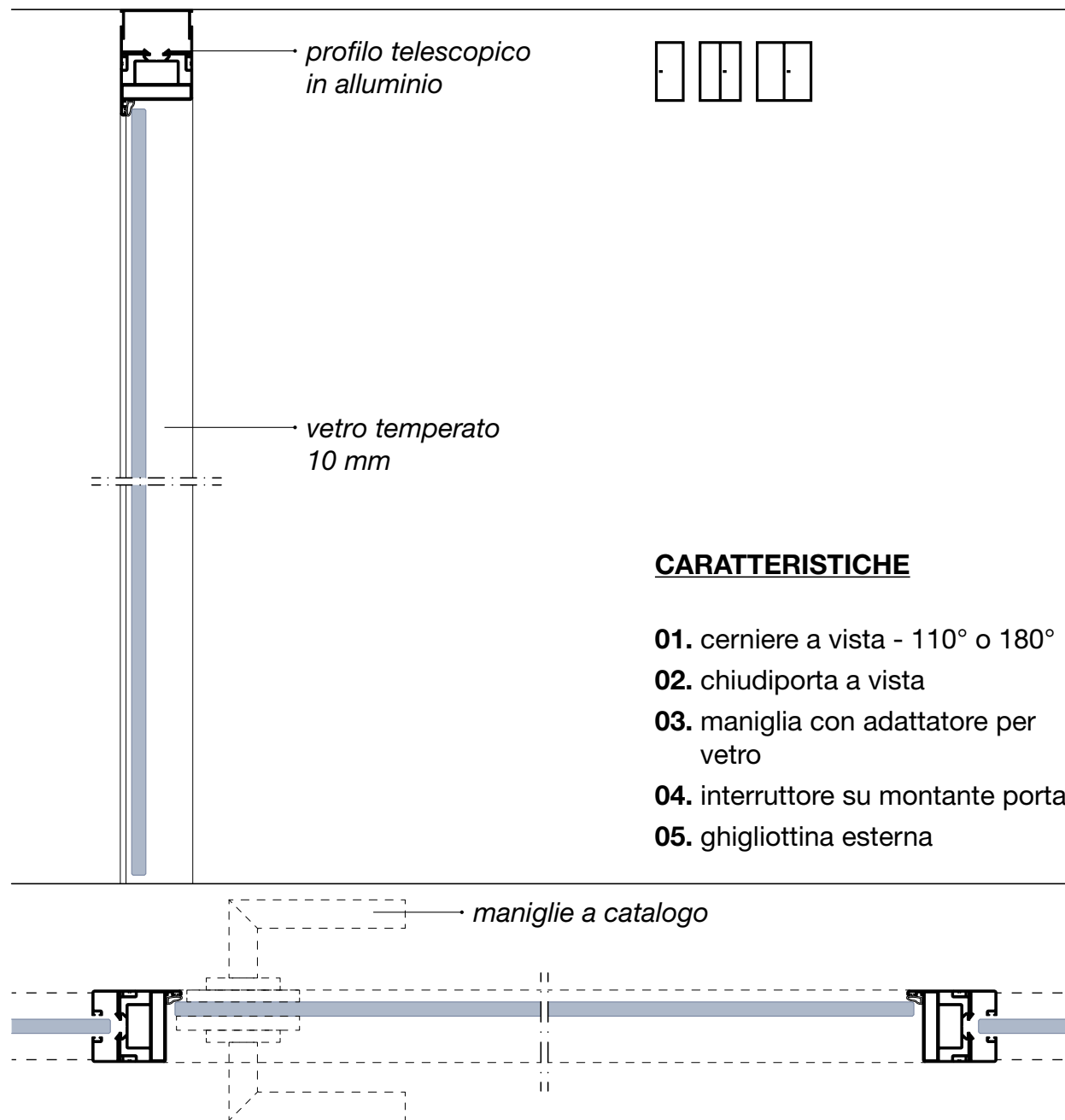

# ANTA VETRO TEMPERATO\_CERNIERE A VISTA sp. 10 mm

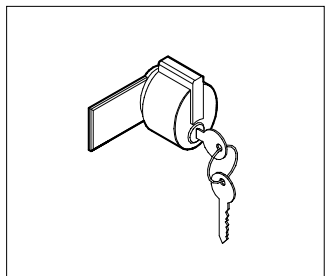

MC1

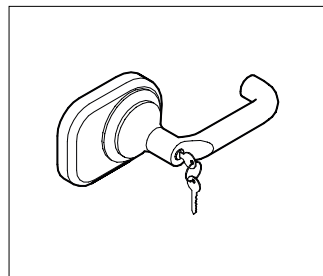

MC4

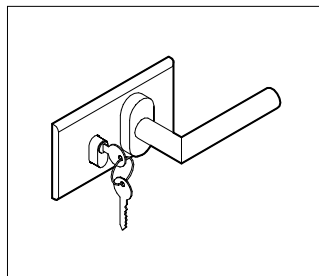

MC5

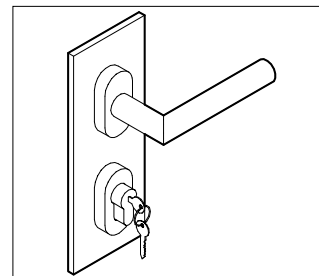

MC5V

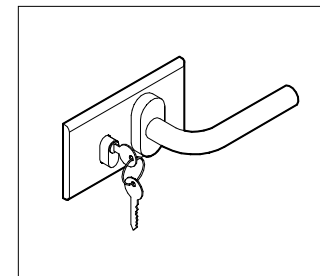

MC6

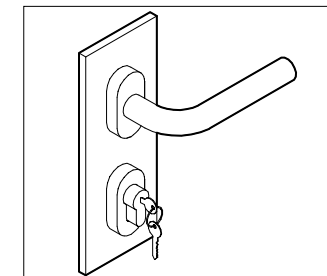

MC6V

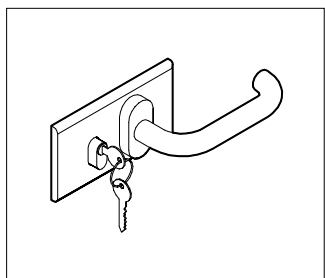

MC7

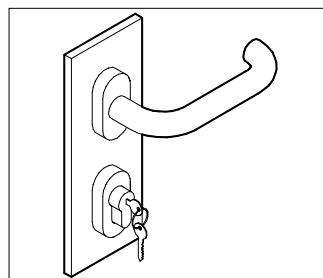

MC7V

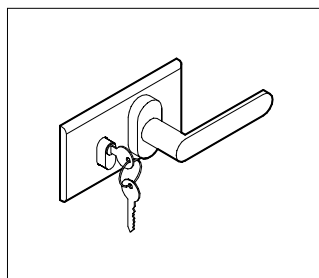

MC8

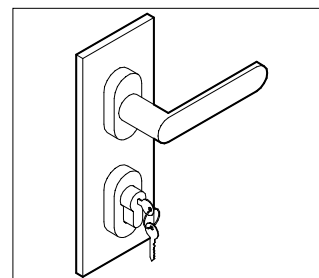

MC8V

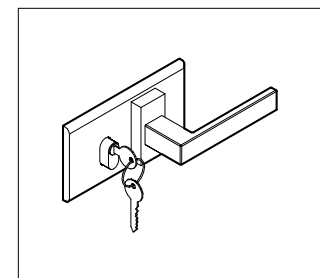

MC9

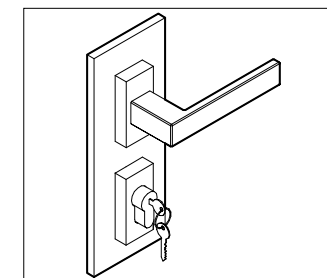

MC9V

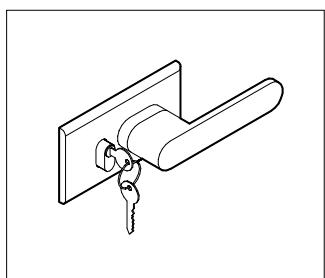

MC10

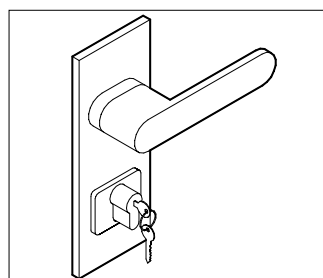

MC10V

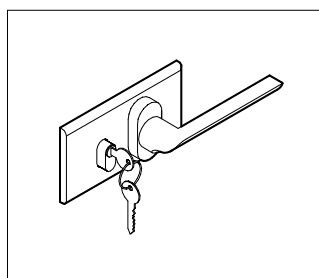

MC11

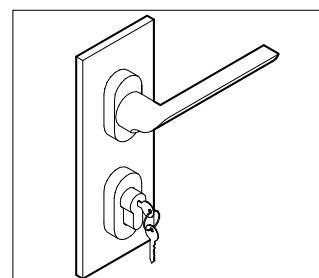

MC11V

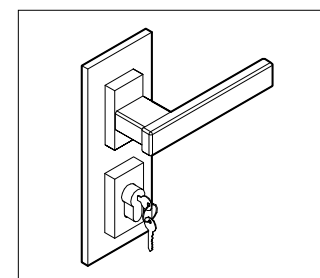

MCQ

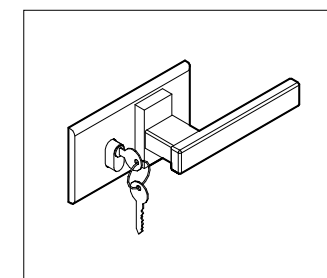

MCQO

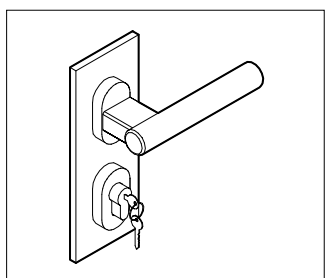

MCT

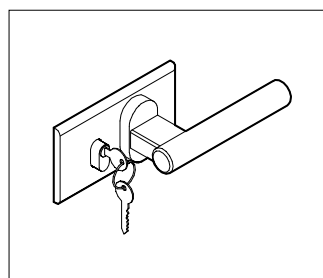

MCTO

# ANTA VETRO TEMPERATO\_CERNIERA CONTINUA sp. 10 mm

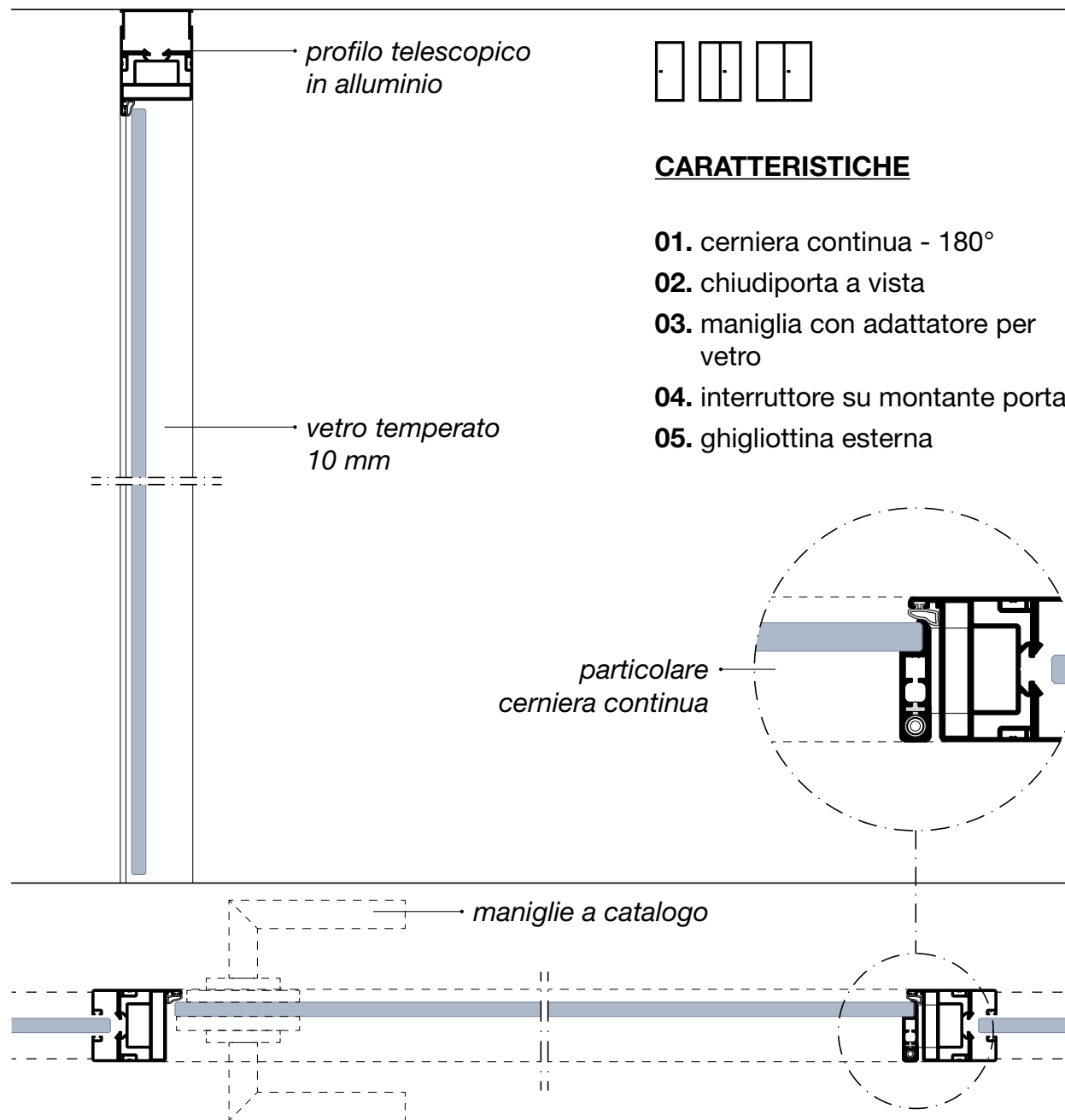

# ANTA VETRO TEMPERATO\_CERNIERA CONTINUA sp. 10 mm

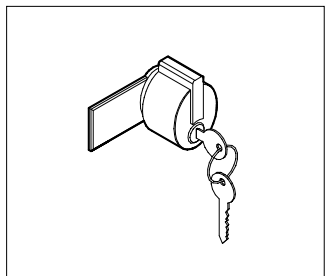

MC1

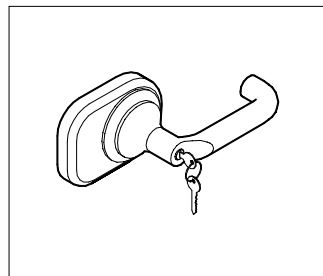

MC4

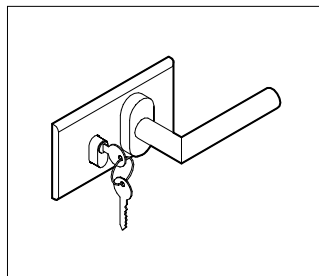

MC5

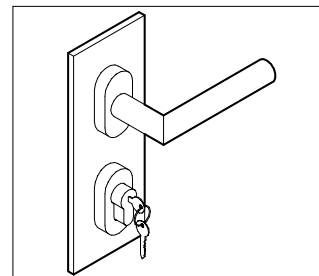

MC5V

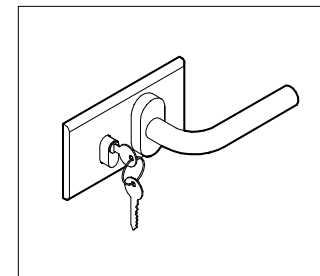

MC6

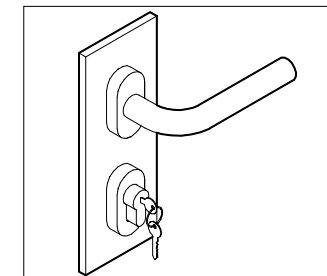

MC6V

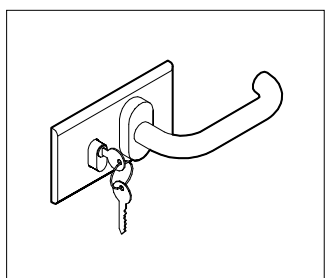

MC7

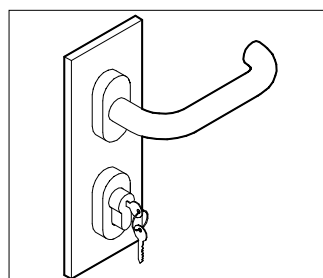

MC7V

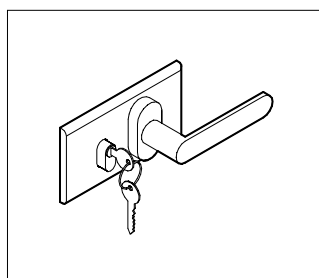

MC8

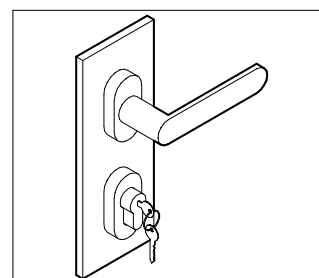

MC8V

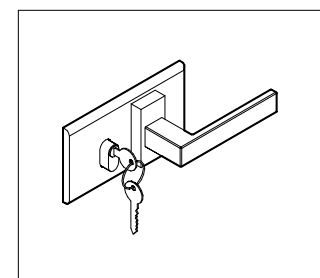

MC9

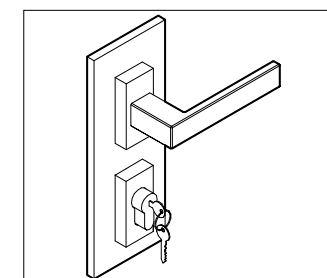

MC9V

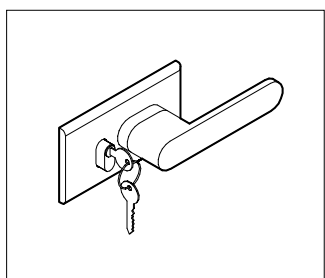

MC10

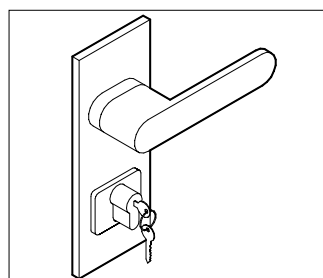

MC10V

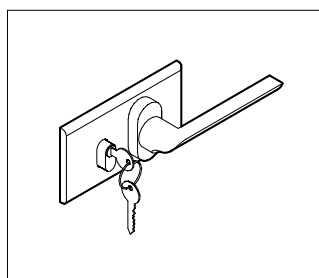

MC11

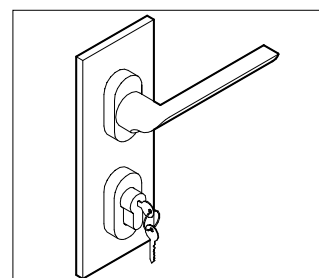

MC11V

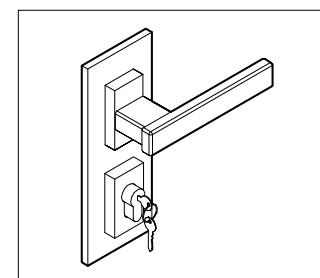

MCQ

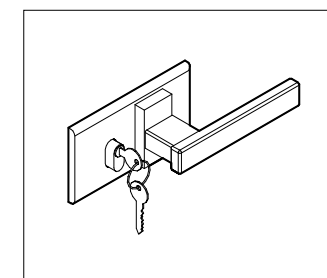

MCQO

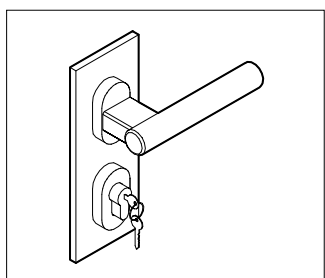

MCT

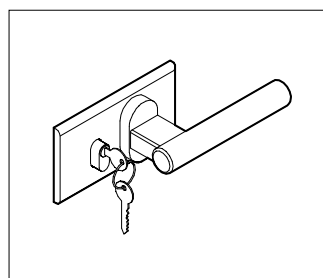

MCTO

# ANTA INTELAIATA GRANDE CON PANNELLO sp. 43 mm

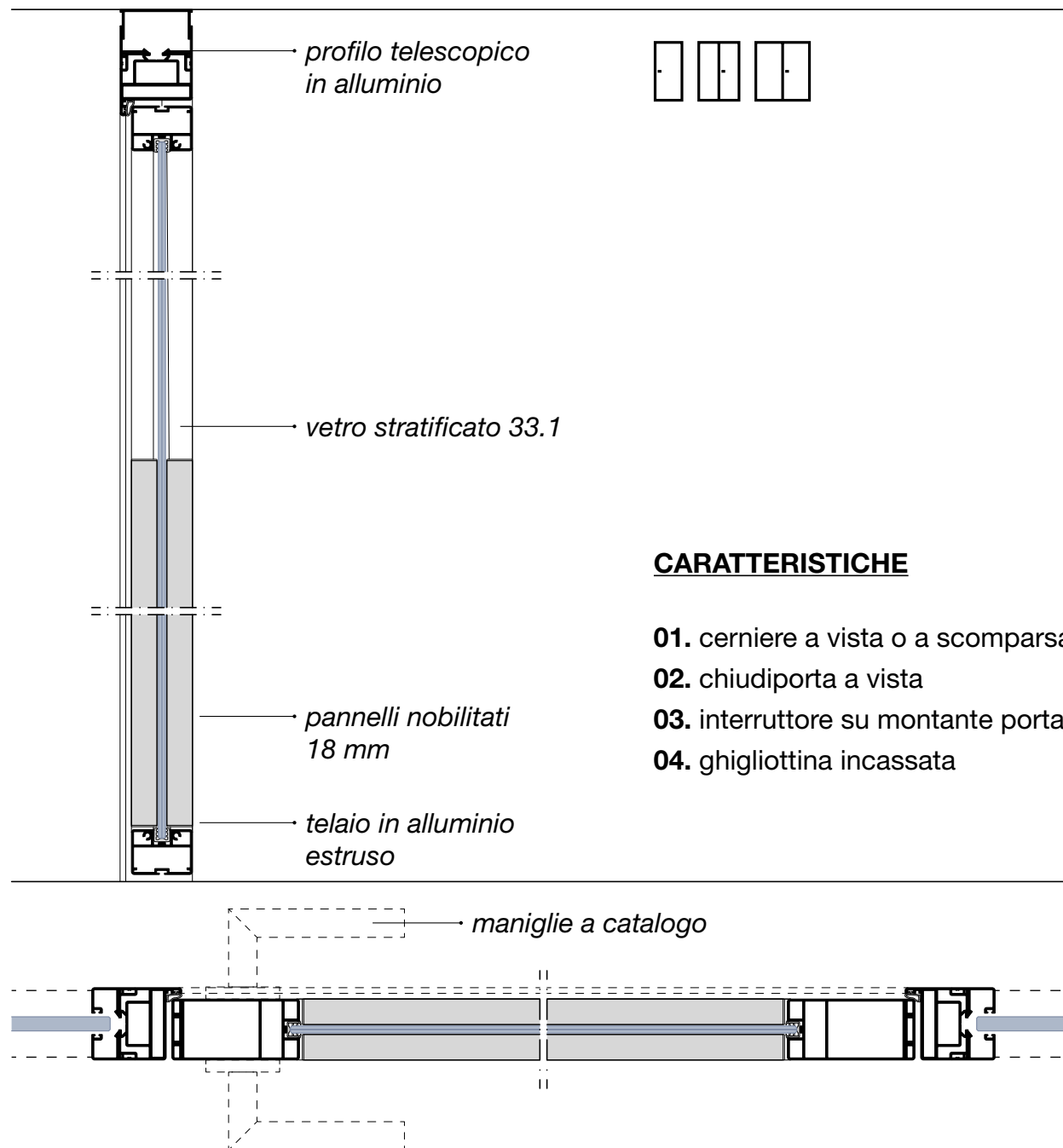

# ANTA INTELAIATA GRANDE CON PANNELLO sp. 43 mm

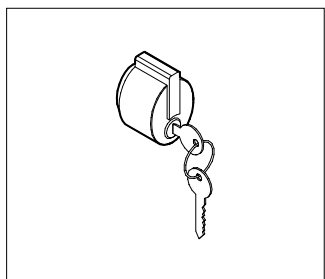

ML1

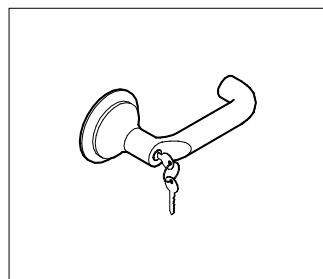

ML4

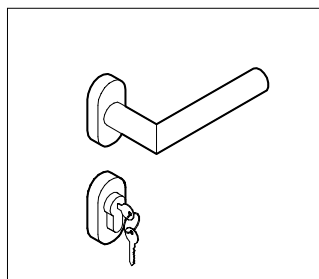

ML5

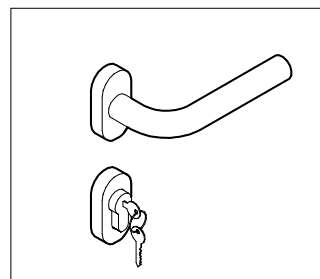

ML6

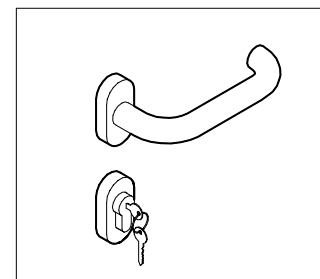

ML7

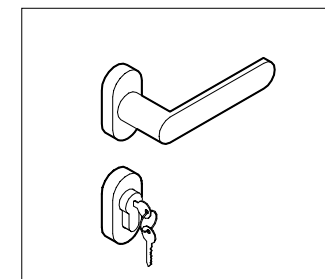

ML8

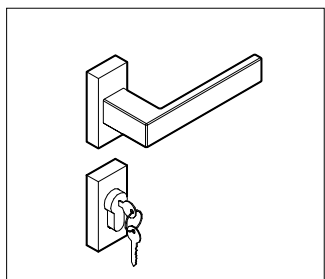

ML9

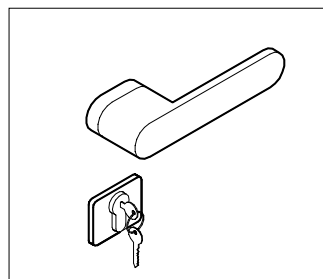

ML10

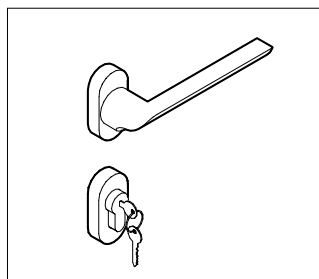

ML11

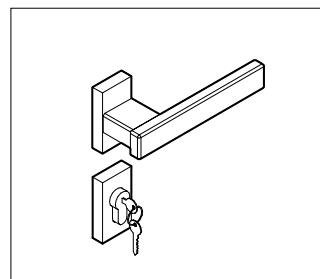

MLQ

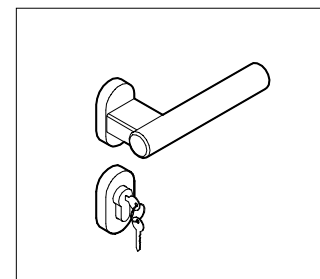

MLT

# ANTA INTELAIATA GRANDE sp. 43 mm

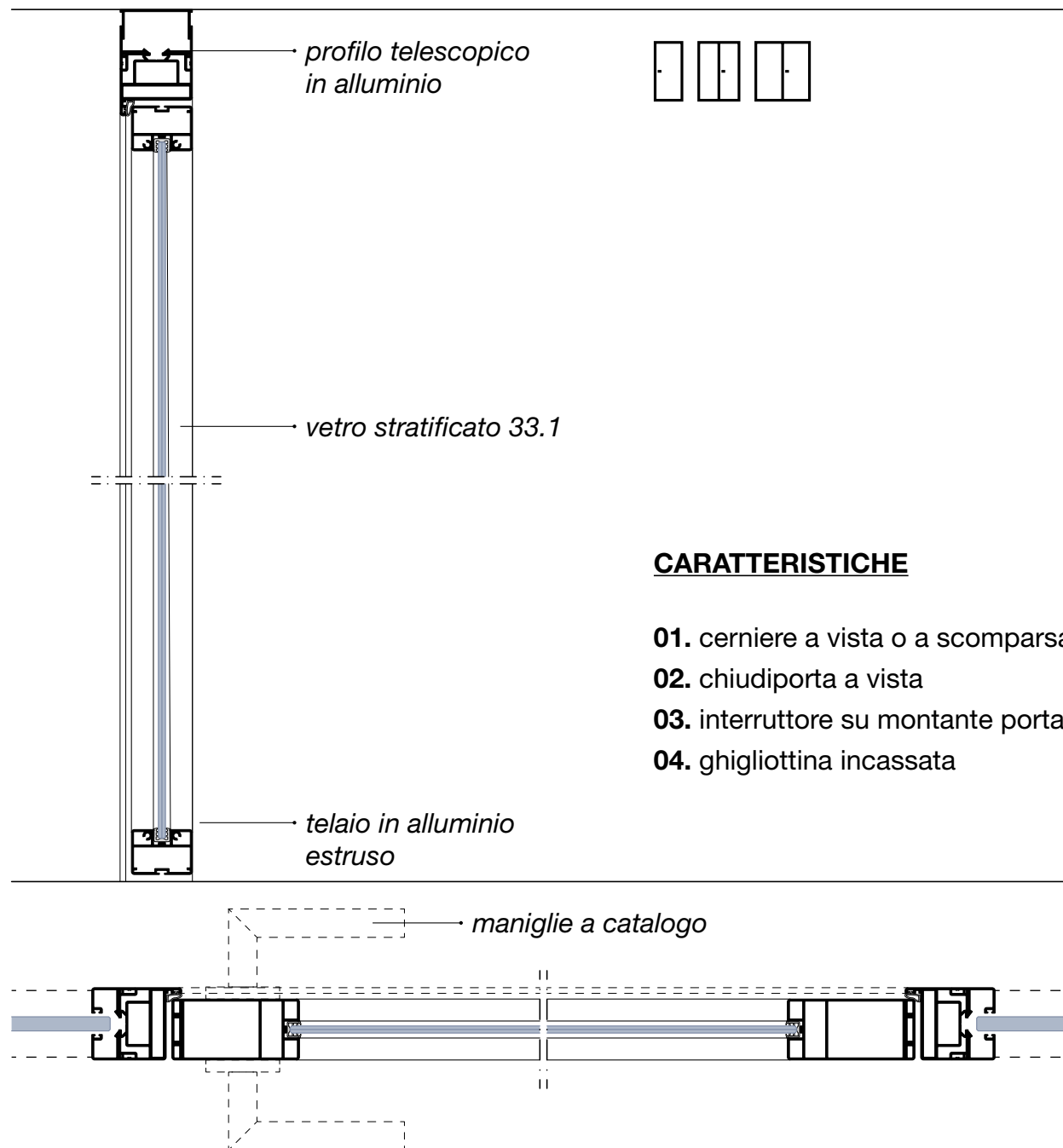
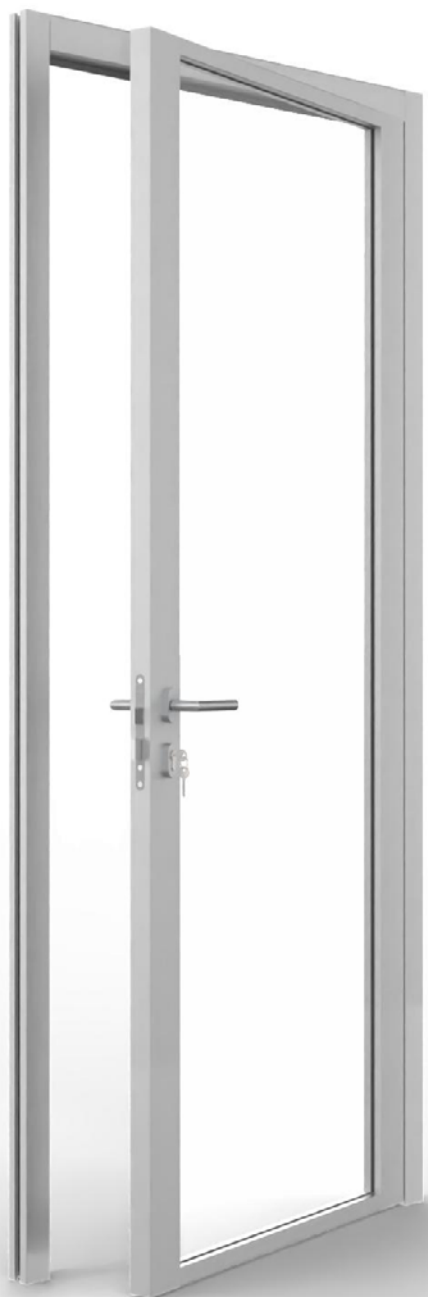



# ANTA INTELAIATA GRANDE sp. 43 mm

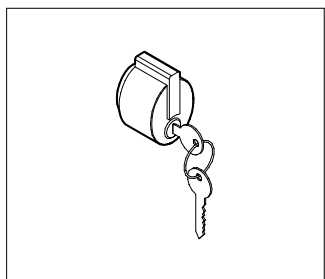

ML1

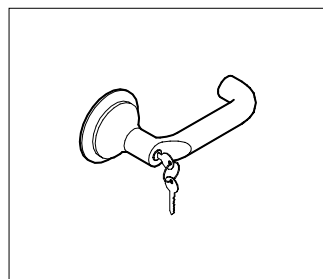

ML4

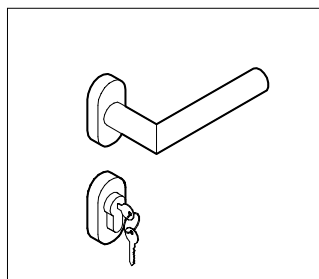

ML5

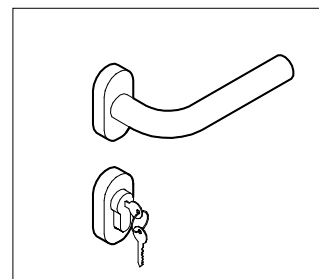

ML6

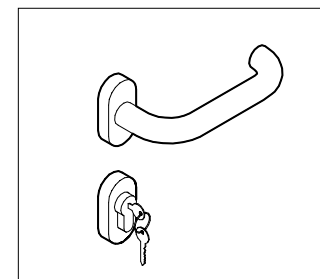

ML7

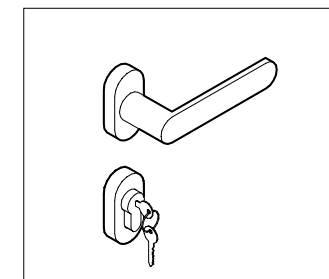

ML8

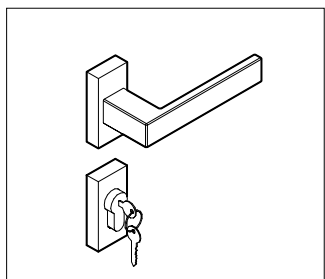

ML9

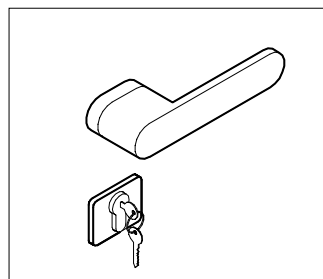

ML10

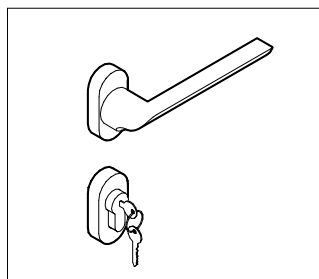

ML11

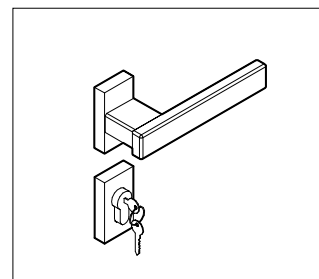

MLQ

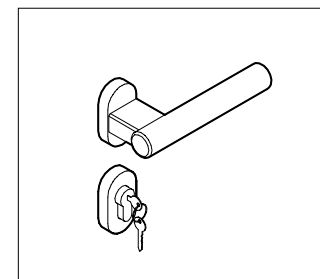

MLT

# ANTA INTELAIATA MEDIA sp. 43 mm

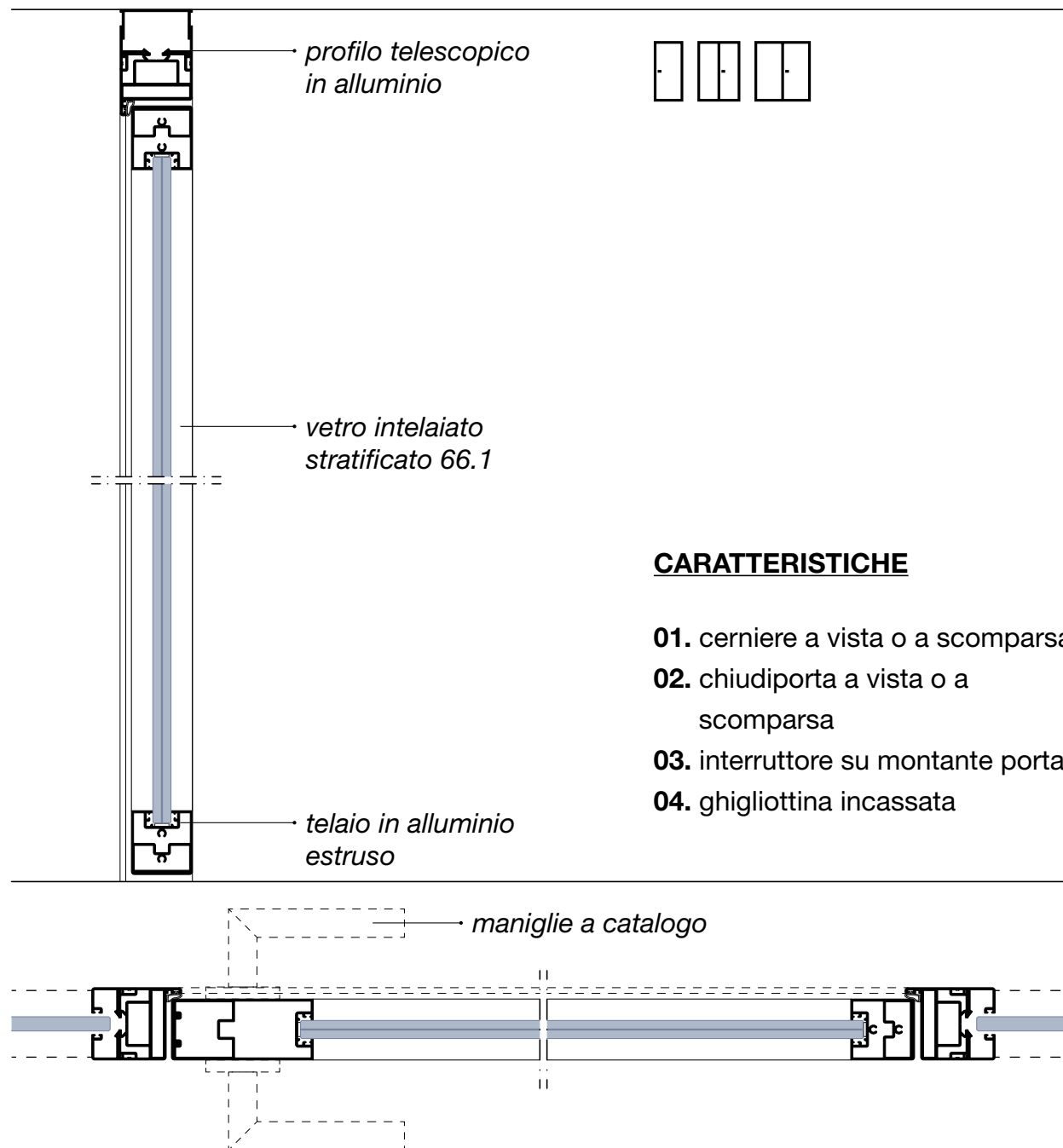

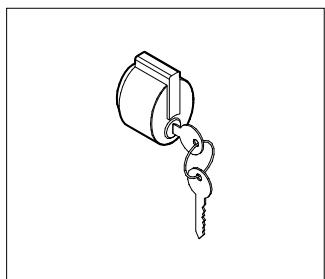

ML1

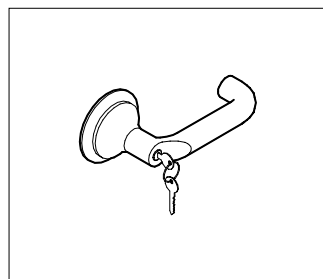

ML4

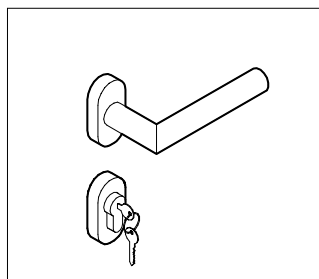

ML5

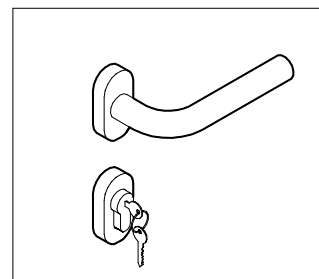

ML6

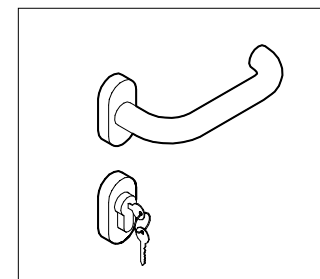

ML7

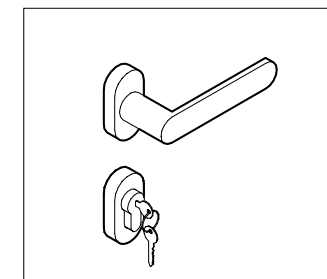

ML8

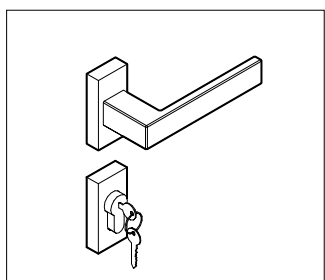

ML9

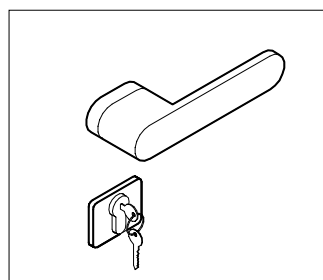

ML10

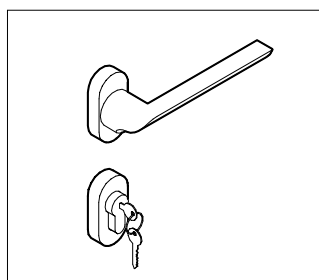

ML11

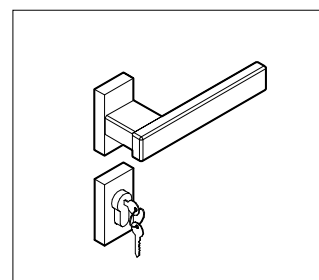

MLQ

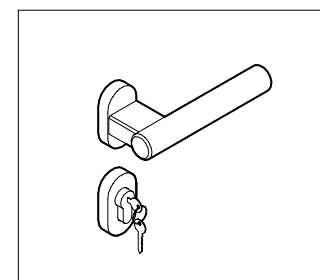

MLT

# ANTA INTELAIATA SOTTILE sp. 43 mm

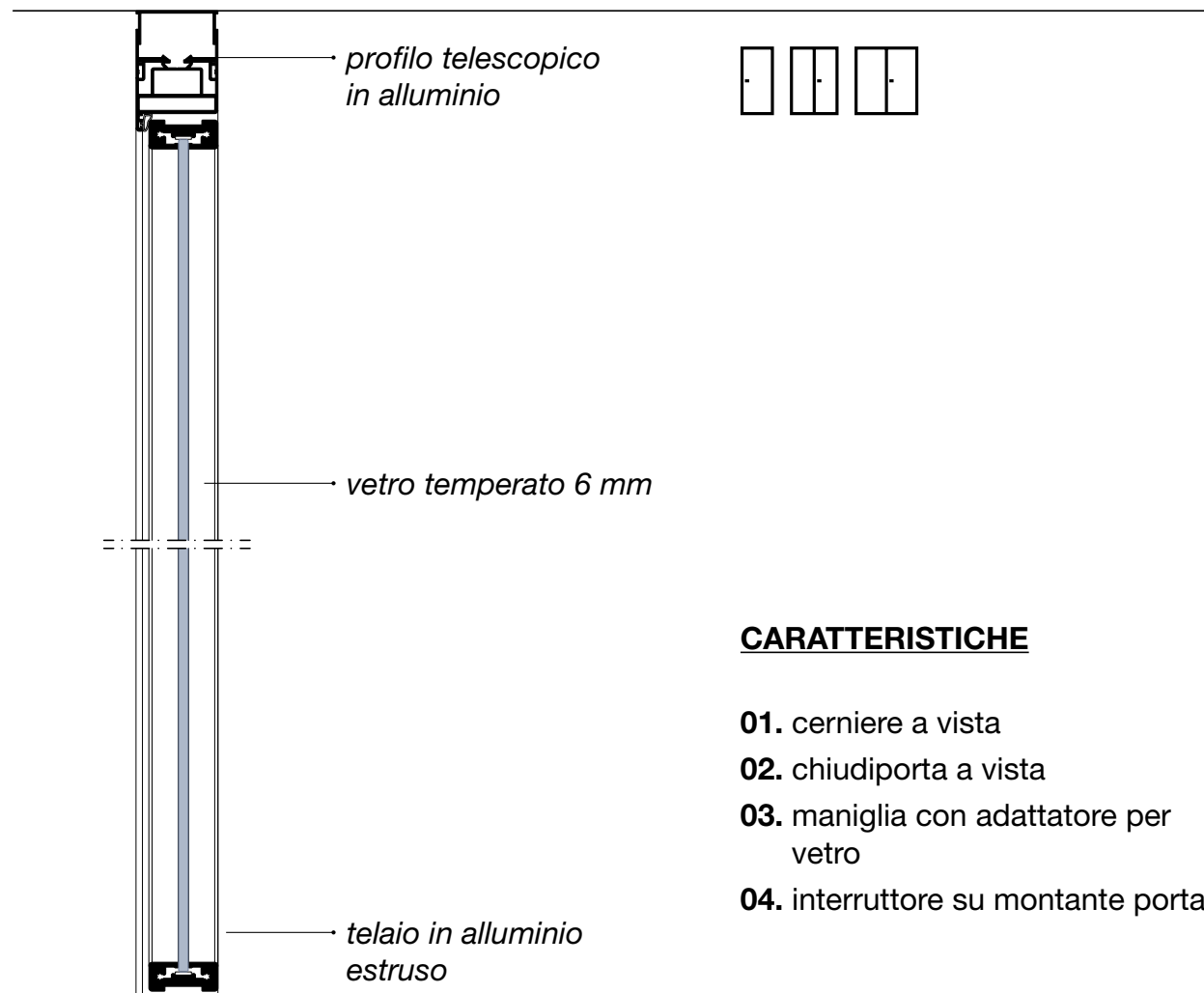

## **CARATTERISTICHE**

- 01.** cerniere a vista
- 02.** chiudiporta a vista
- 03.** maniglia con adattatore per vetro
- 04.** interruttore su montante porta

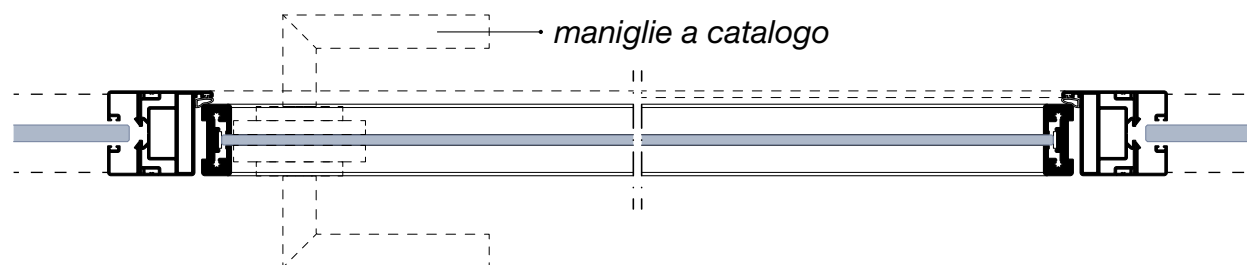

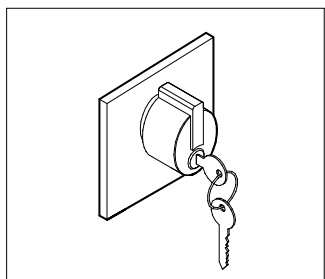

**ML1**

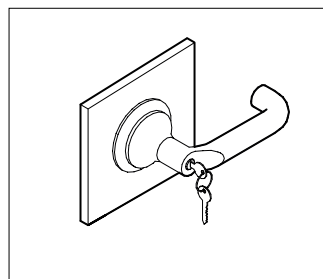

**ML4**

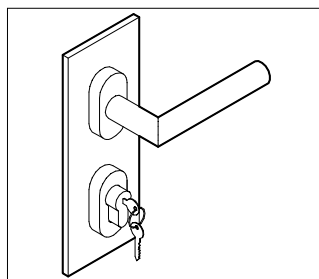

**ML5**

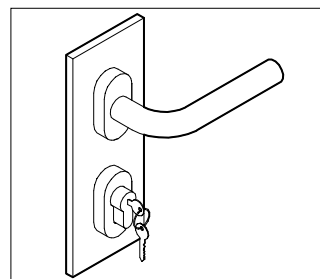

**ML6**

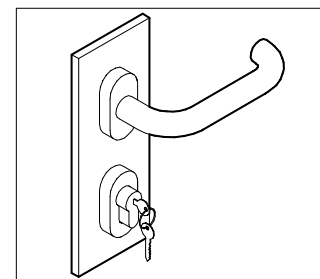

**ML7**

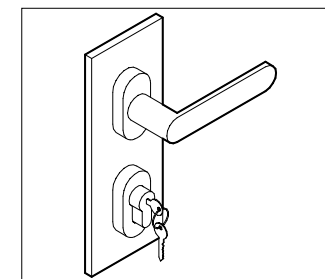

**ML8**

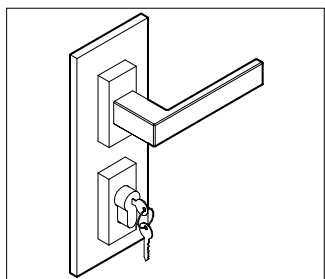

**ML9**

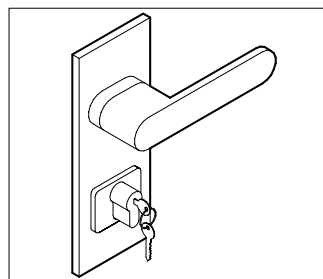

**ML10**

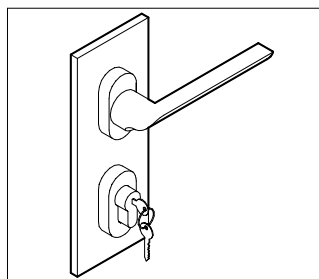

**ML11**

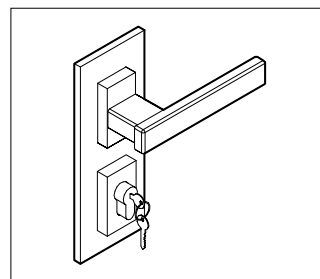

**MLQ**

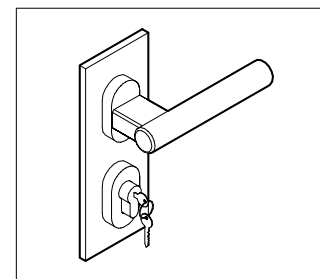

**MLT**

# ANTA INTELAIATA VETRO DOPPIO sp. 51 mm

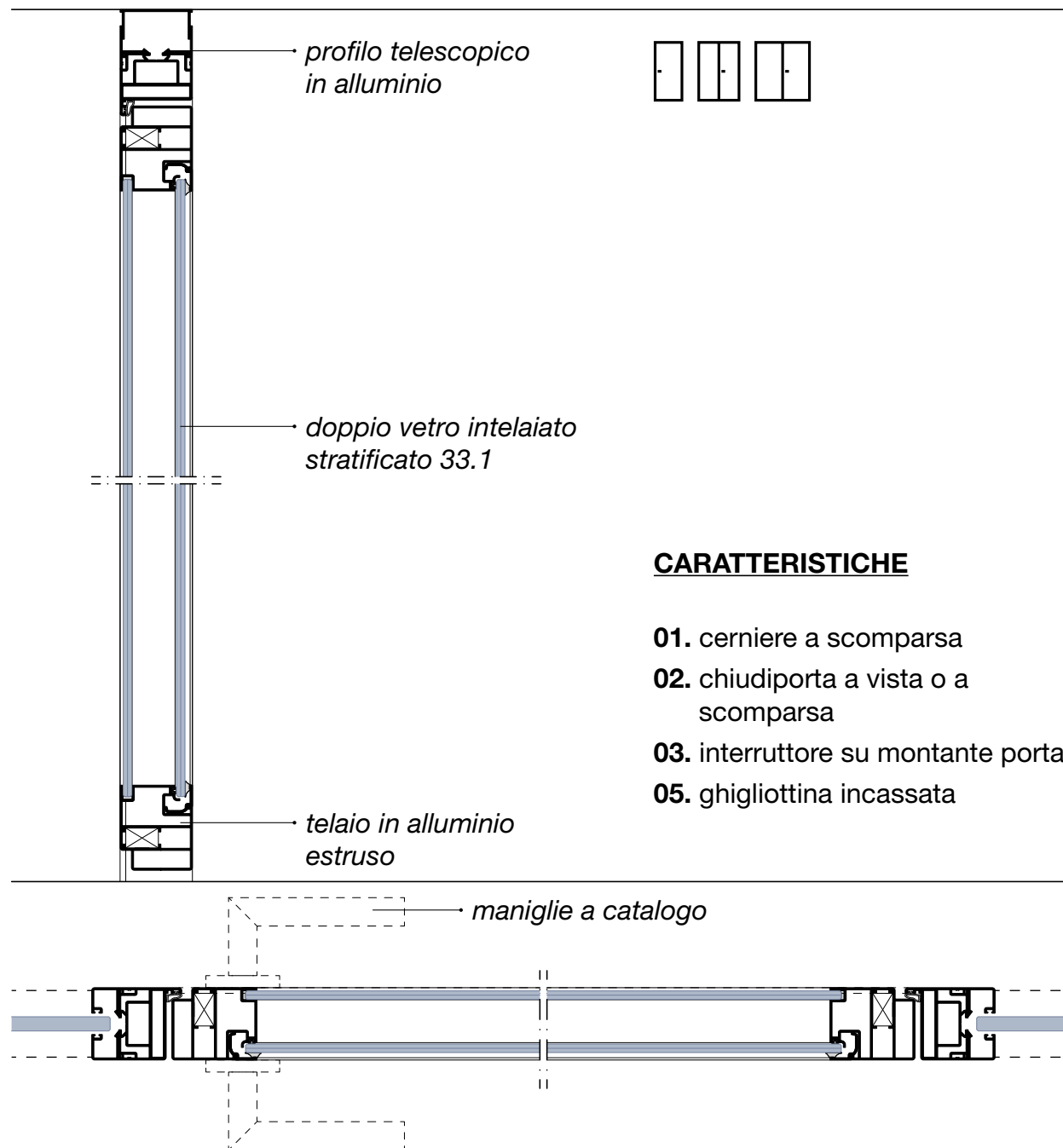

# ANTA INTELAIATA VETRO DOPPIO sp. 51 mm

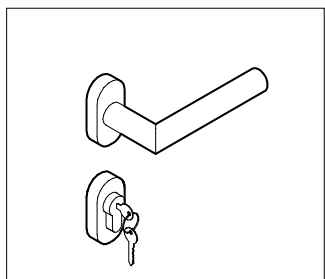

ML5

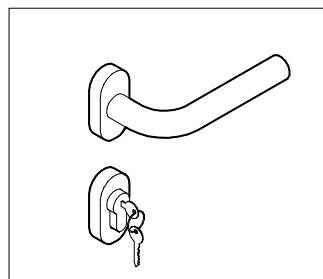

ML6

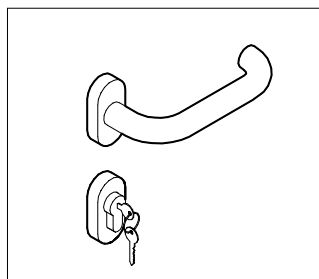

ML7

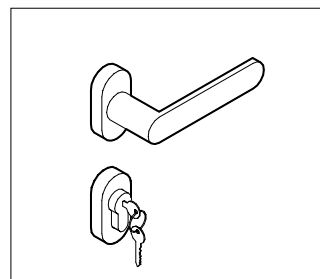

ML8

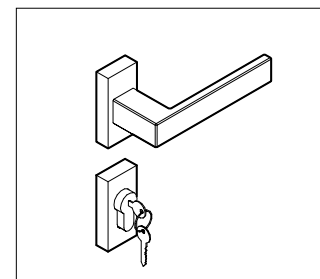

ML9

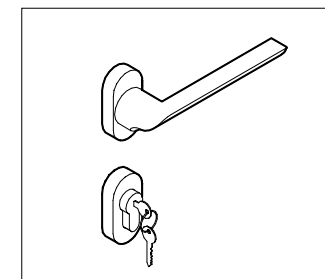

ML11

# TELAI PORTE SCORREVOLI



Telaio porta su **Unica Slim**

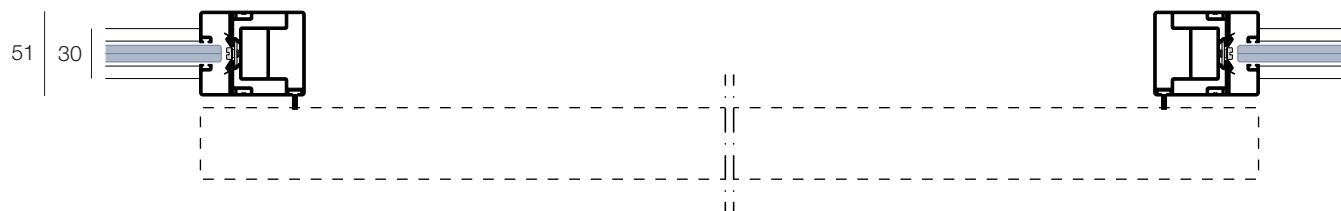

Telaio porta su **Unica U**

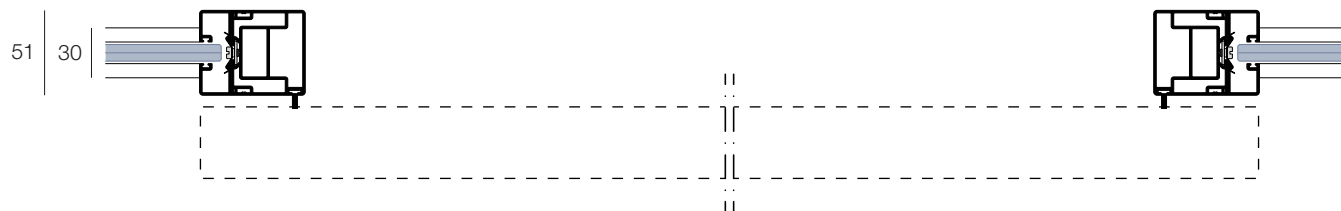

Telaio porta su **Unica SC1/SC2/SC3**

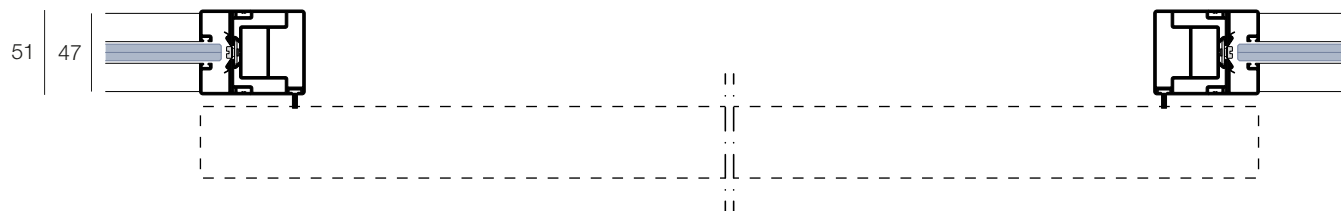

Telaio porta su **Unica R**

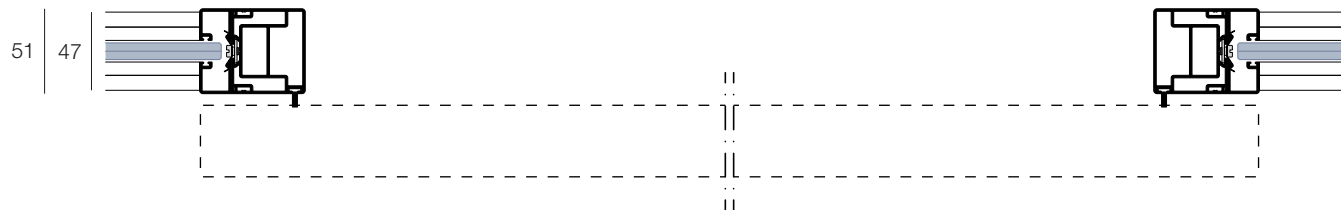

Telaio porta su **Unica D**

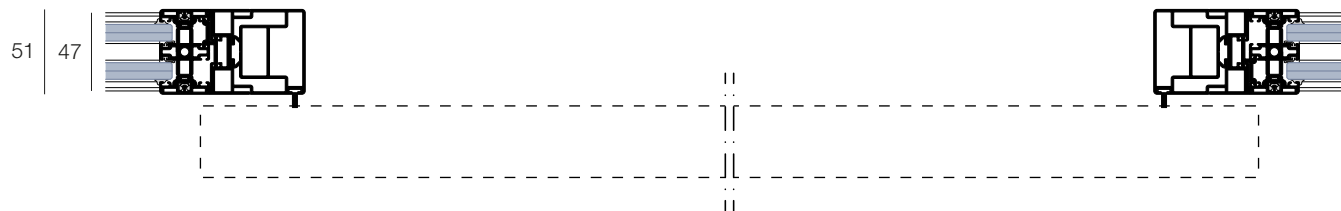



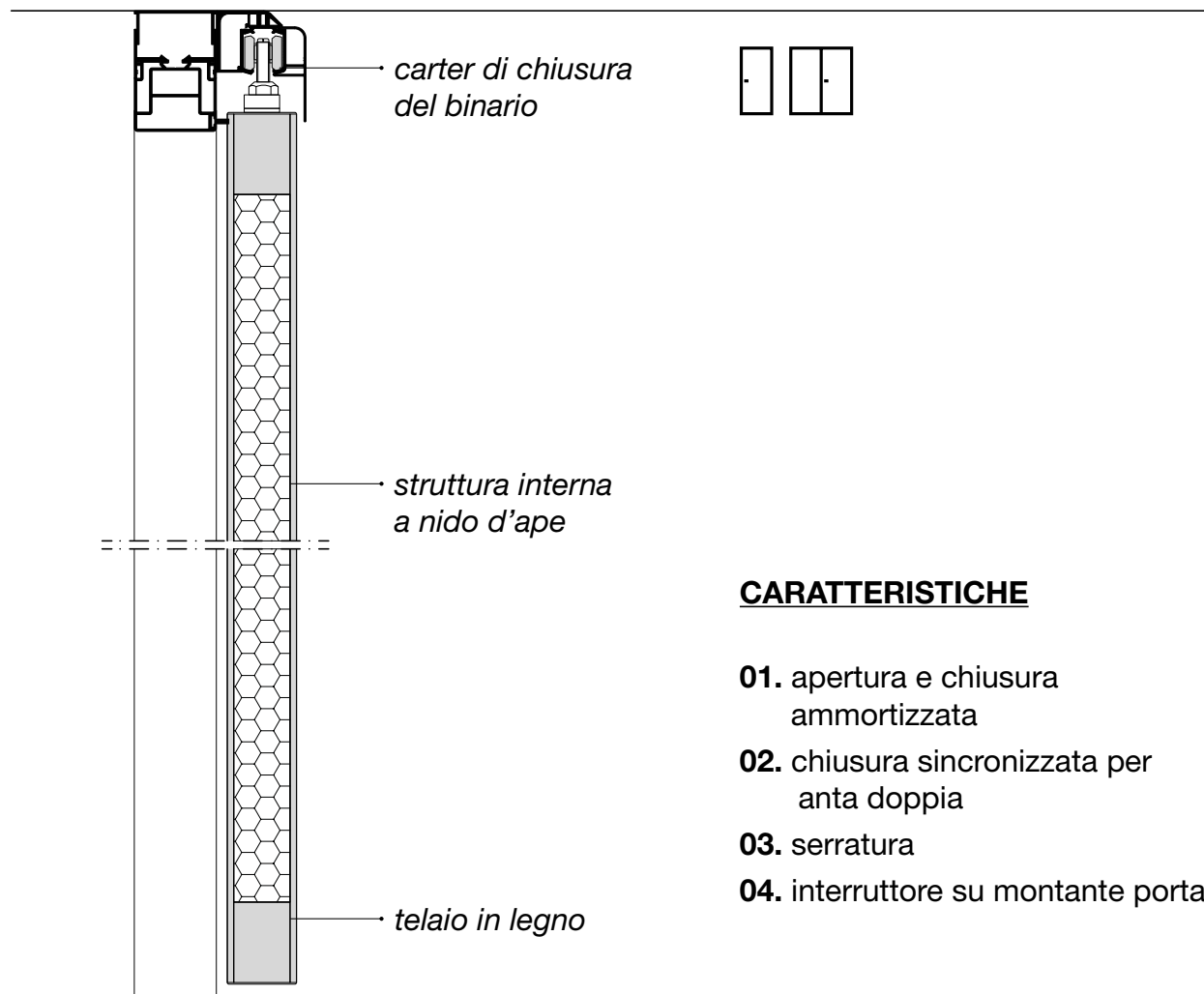

### **CARATTERISTICHE**

- 01.** apertura e chiusura ammortizzata
- 02.** chiusura sincronizzata per anta doppia
- 03.** serratura
- 04.** interruttore su montante porta

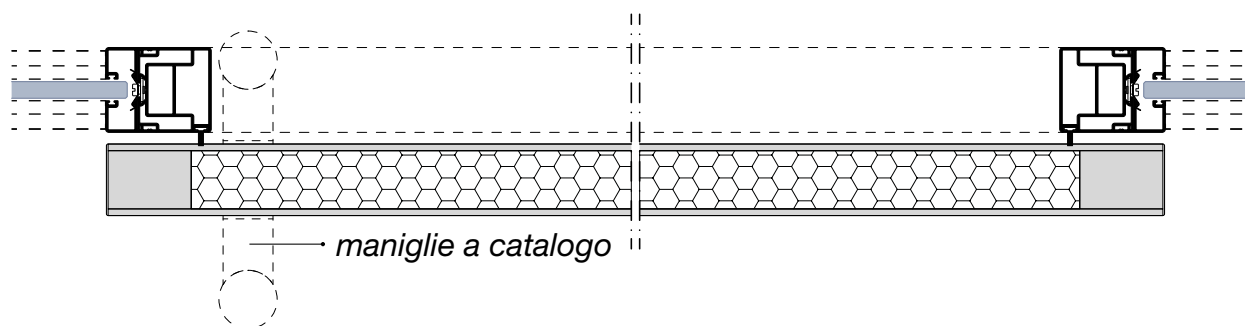

# ANTA VETRO TEMPERATO sp. 10 mm

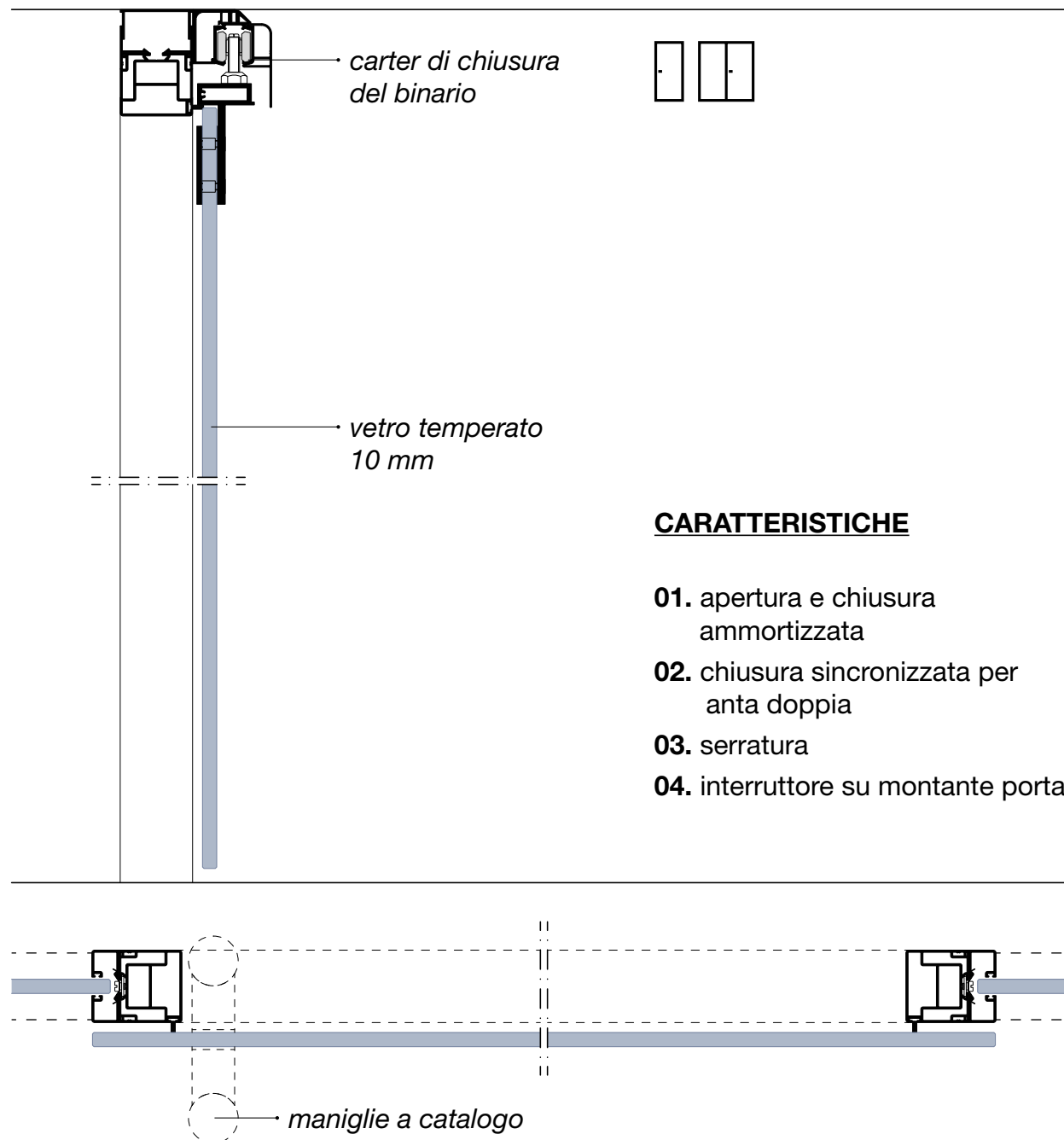

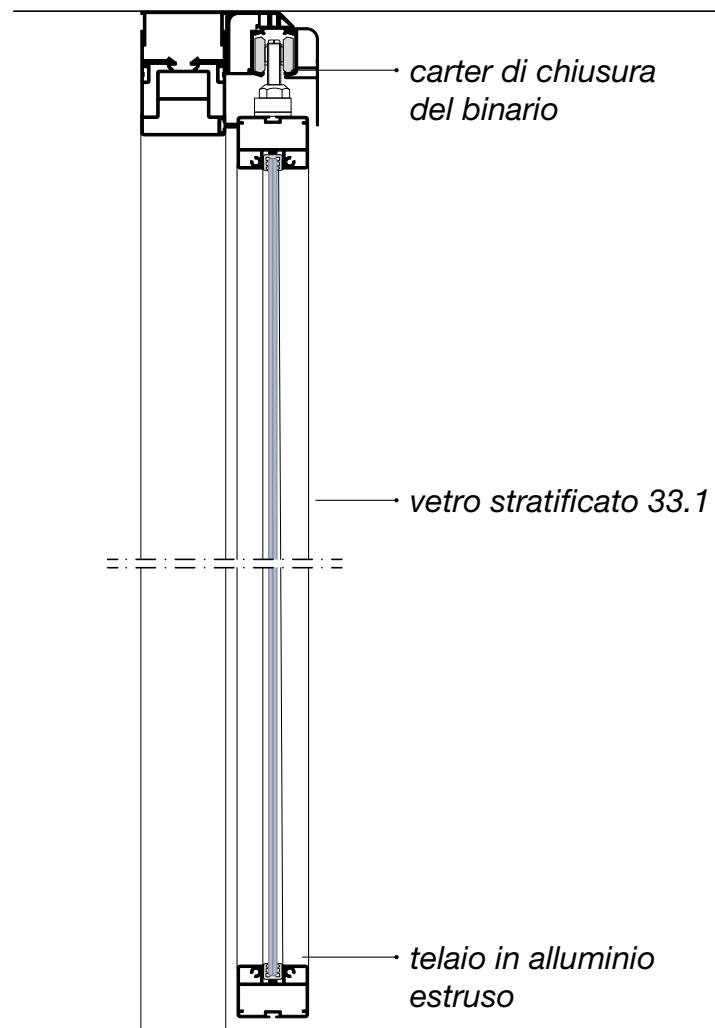
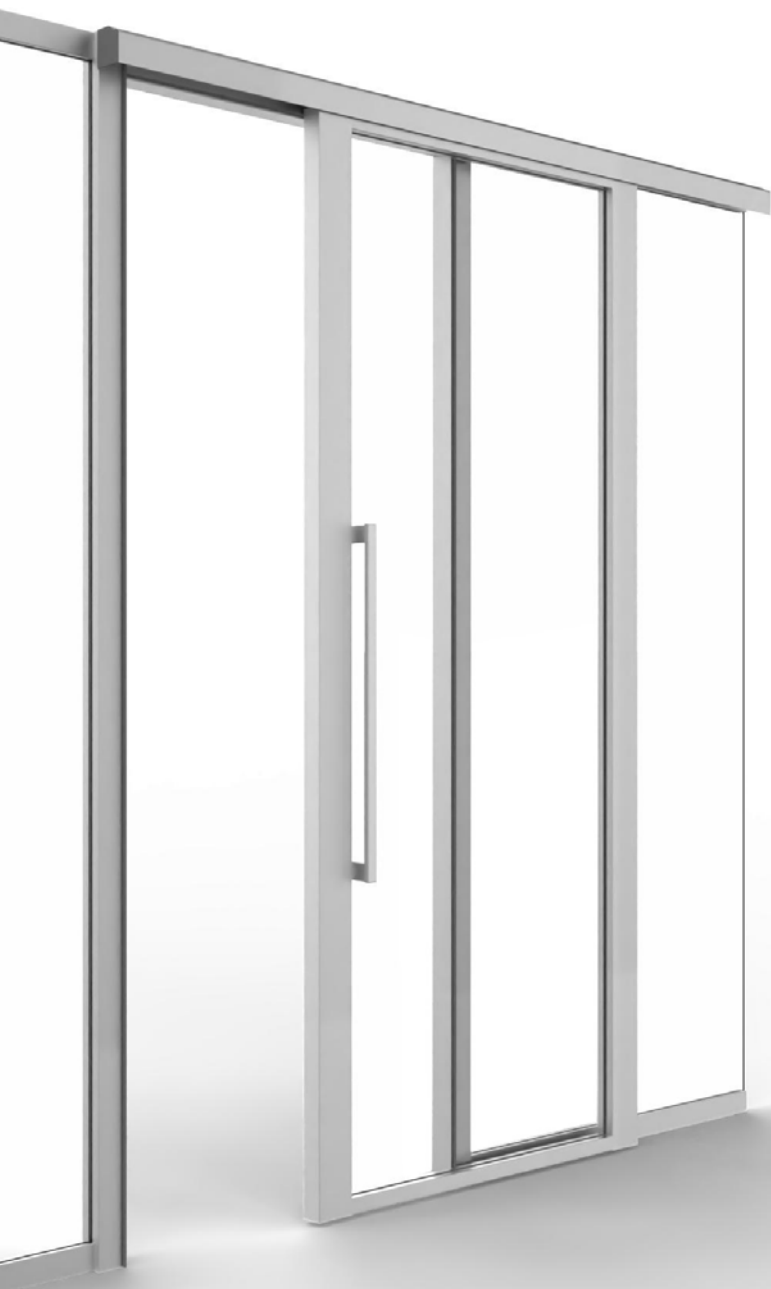

### CARATTERISTICHE

- 01. apertura e chiusura ammortizzata
- 02. chiusura sincronizzata per anta doppia
- 03. serratura
- 04. interruttore su montante porta

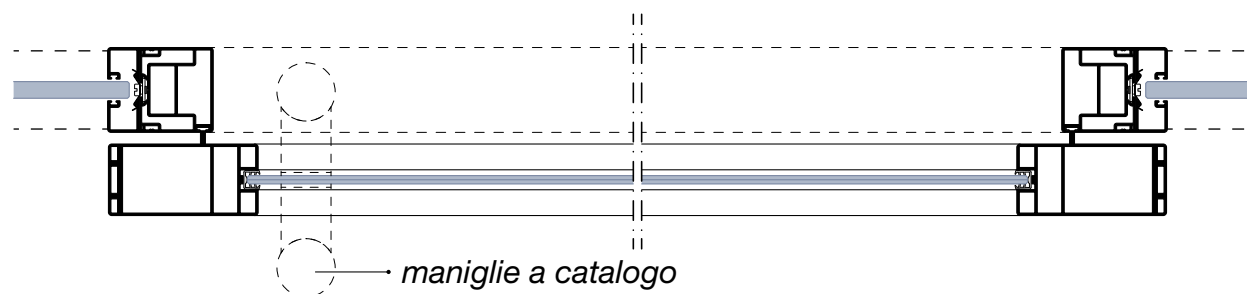

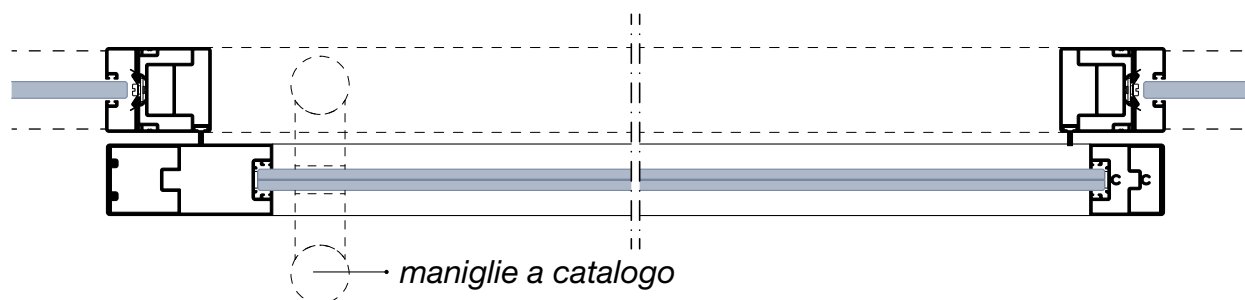
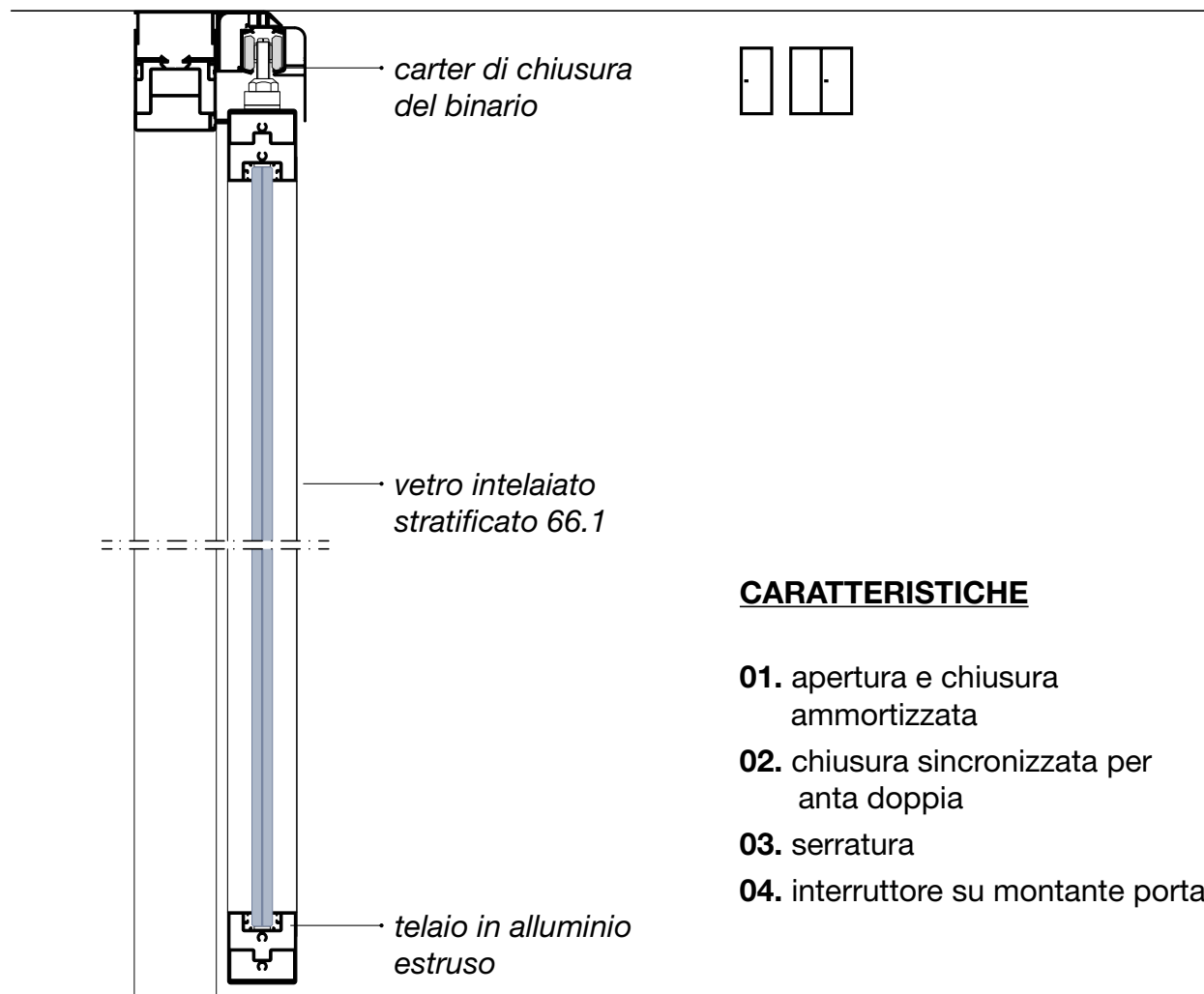
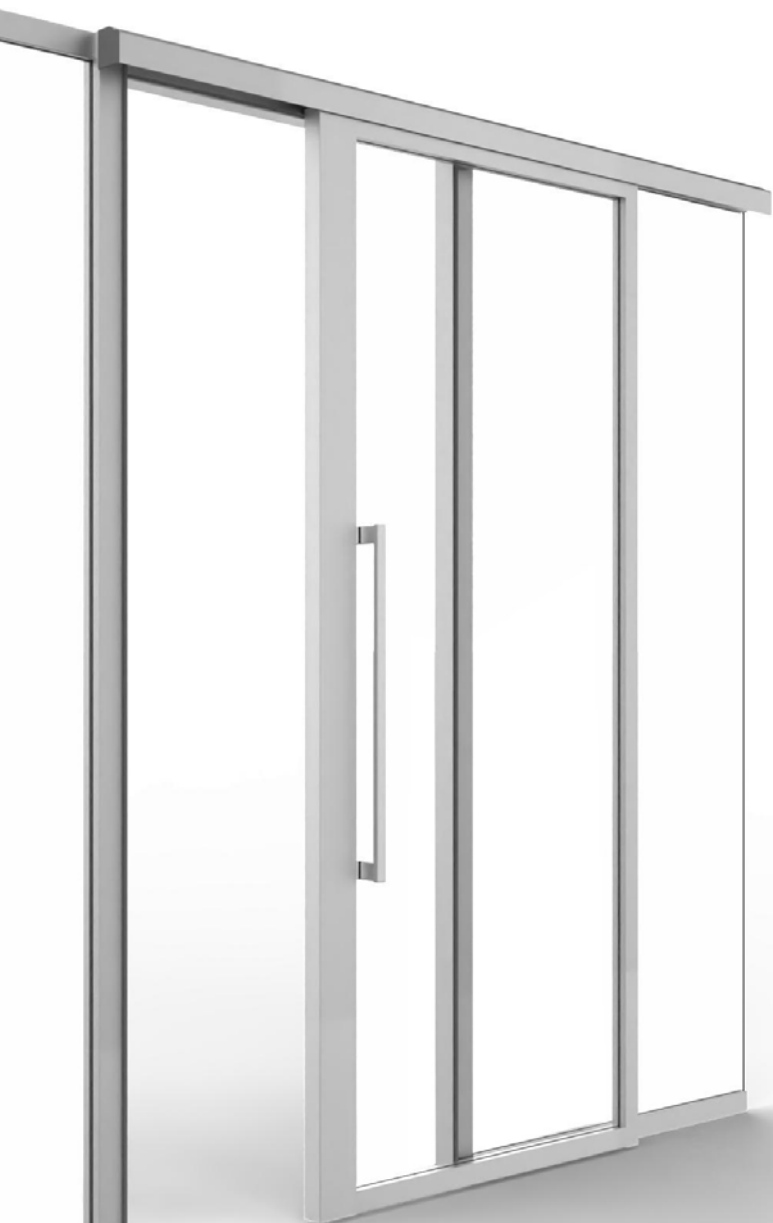

# ANTA INTELAIATA SOTTILE sp. 43 mm

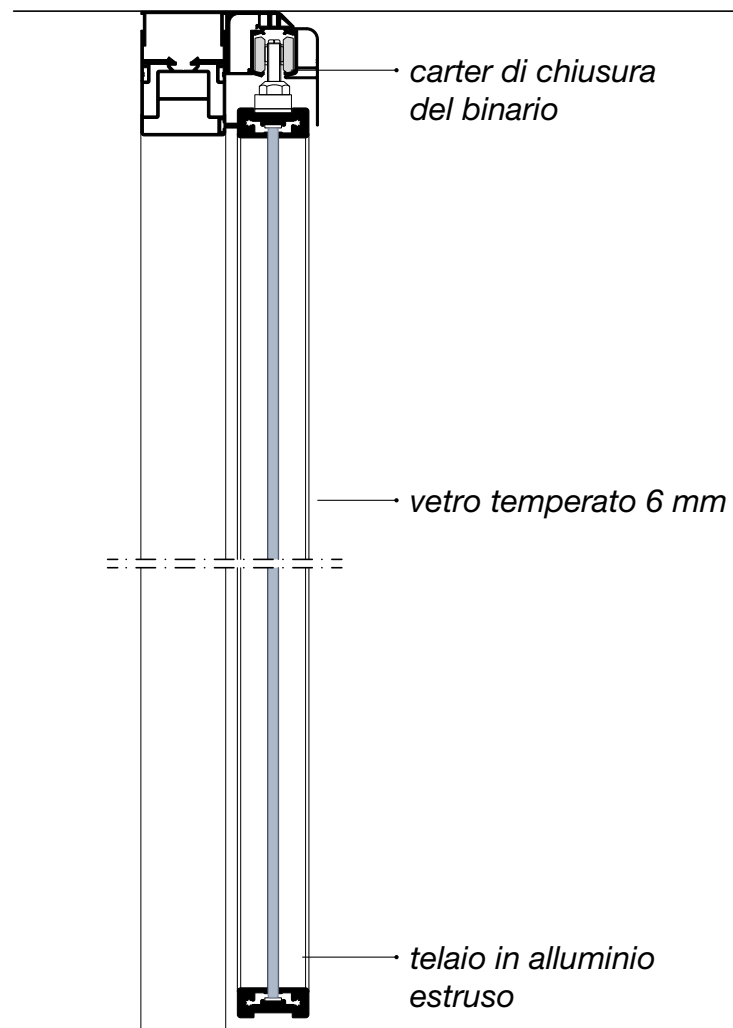

## CARATTERISTICHE

01. apertura e chiusura ammortizzata
02. chiusura sincronizzata per anta doppia
03. serratura
04. interruttore su montante porta

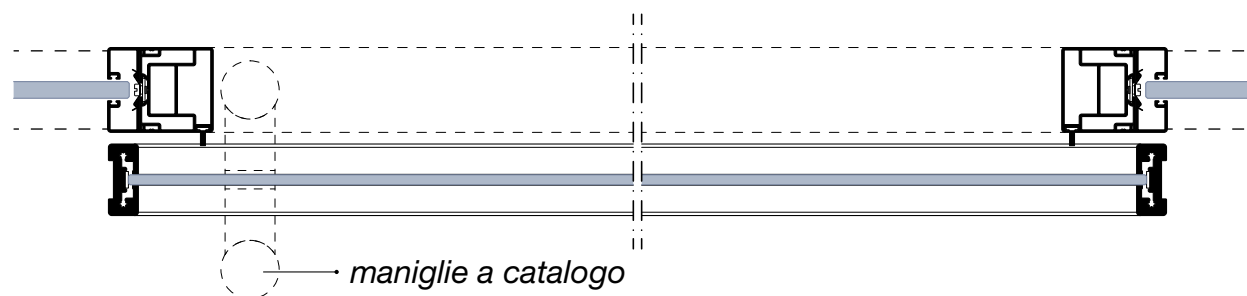

# Porte in vetro



ACCIAIO

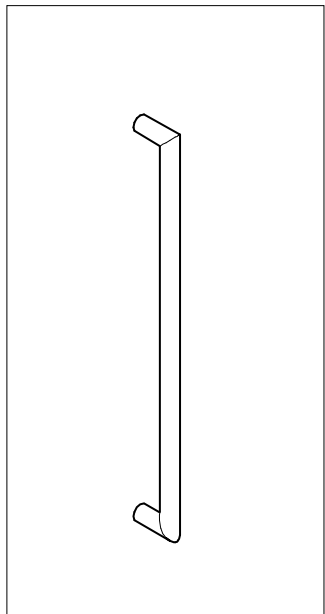

**MPOMGH1\_H2\_H3**

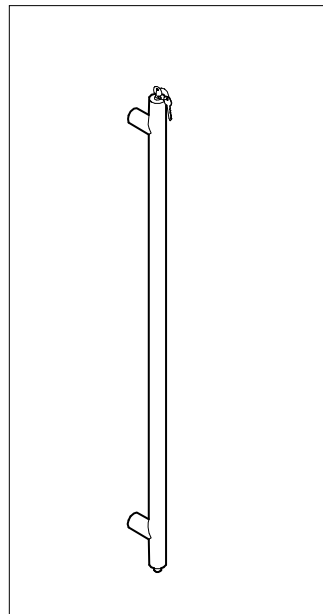

**MPOM2**

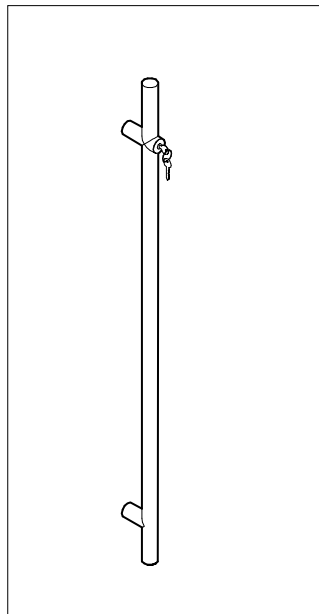

**MPOM3**

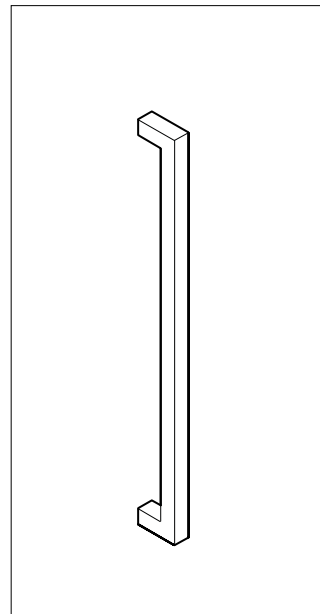

**MPOMGH1Q\_GH2Q\_GH3Q**

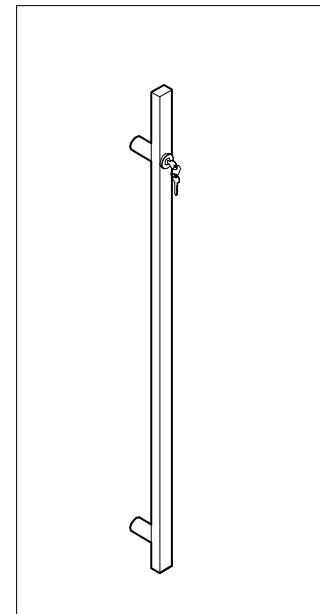

**MPOM3Q**

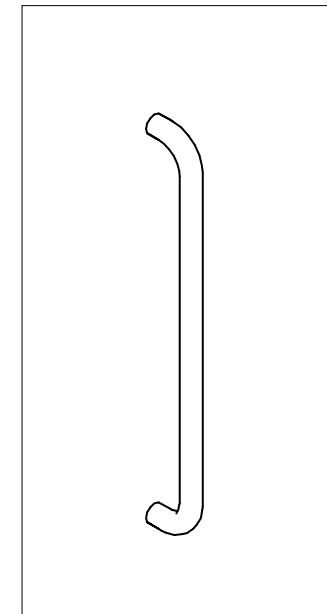

**MPOM8**

ALLUMINIO

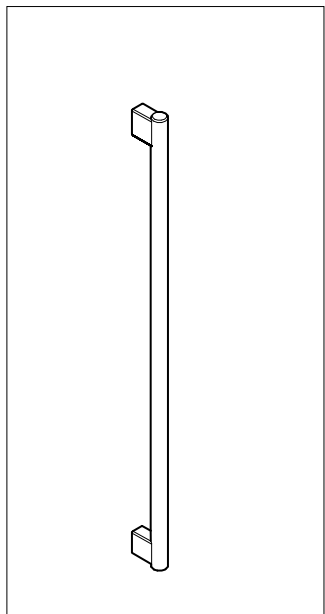

**MPOMTH1\_TH2**

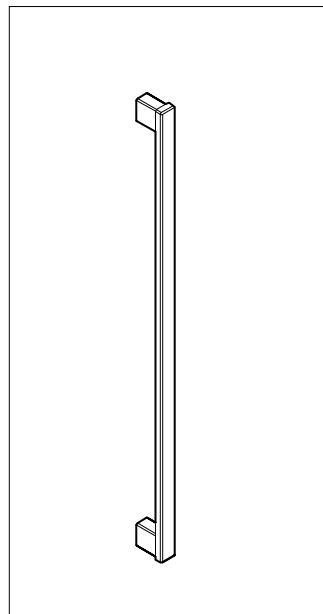

**MPOMQH1\_QH2**

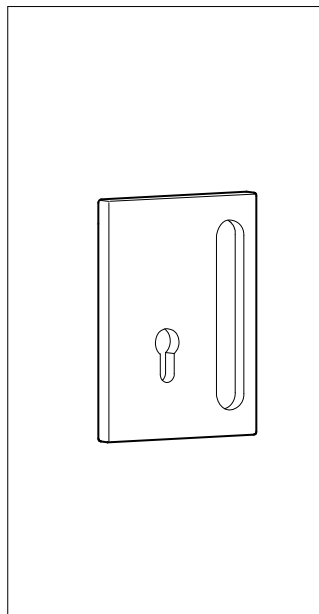

**MPOM6**

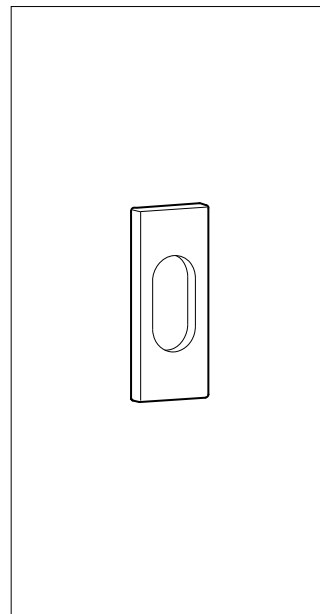

**MPOM7**

# Porte cieche



ACCIAIO

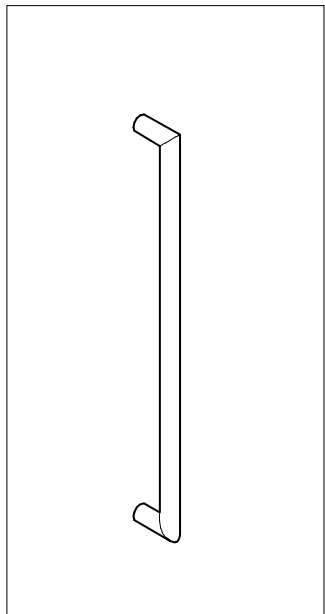

**MPOMGH1\_H2\_H3**

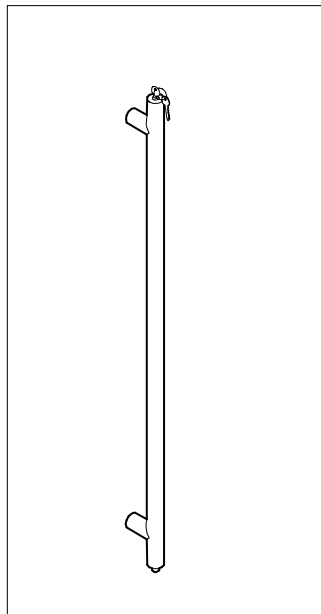

**MPOM2**

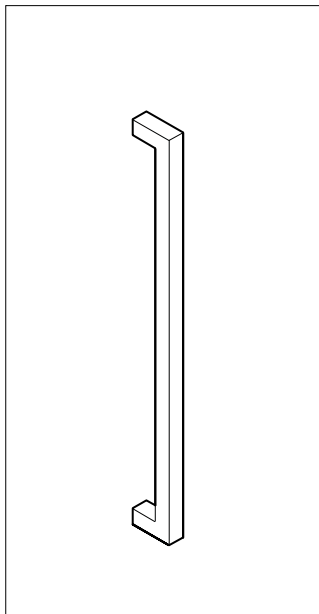

**MPOMGH1Q\_GH2Q\_GH3Q**

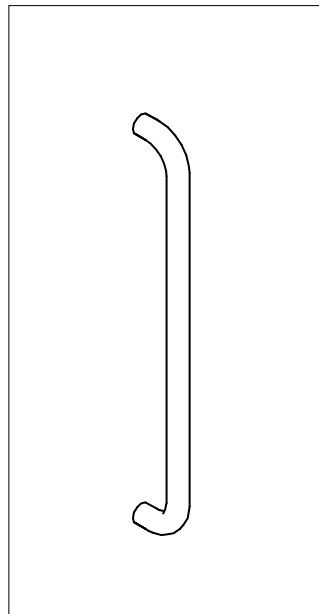

**MPOM8**

ALLUMINIO

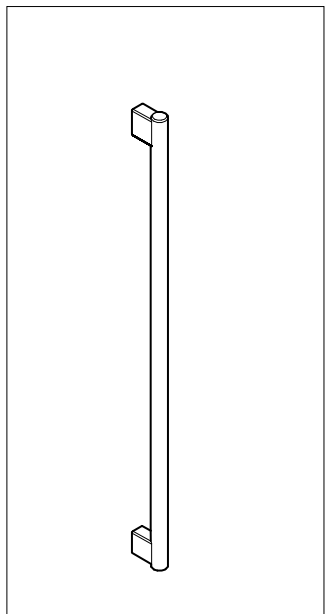

**MPOMTH1\_TH2**

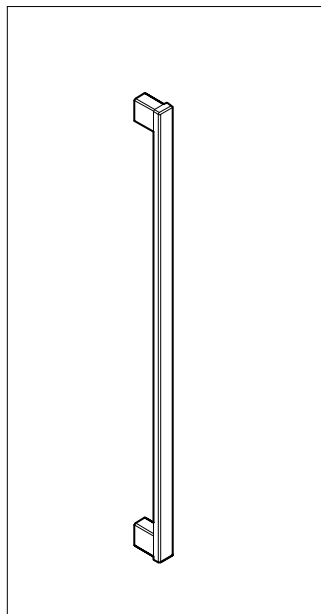

**MPOMQH1\_QH2**

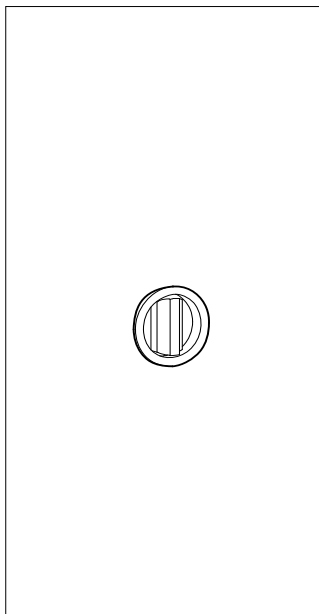

**MPOM4**

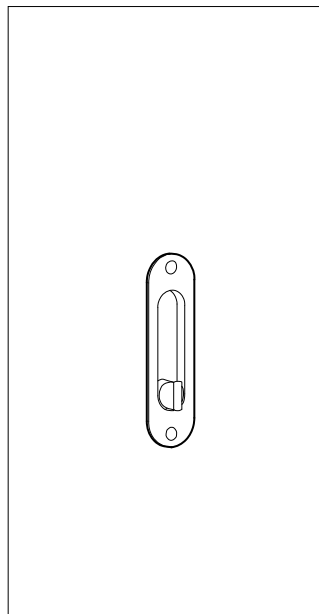

**MPOM5**

**UNICA®**

Accessori

---





## Chiudiporta aerei

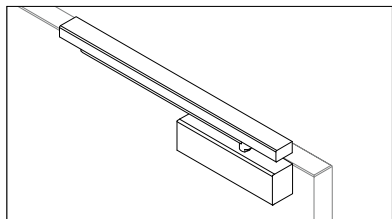

**01 esterno a slitta**  
*per anta cieca/intelaiata*

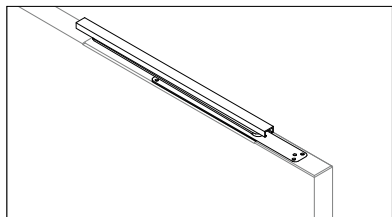

**02 a scomparsa**  
*per anta cieca/intelaiata*

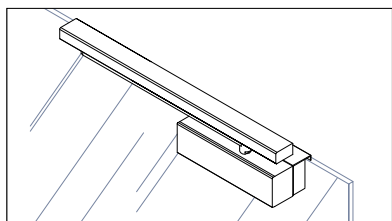

**03 esterno a slitta con supporto**  
*per anta in vetro temperato*

## Chiudiporta a terra

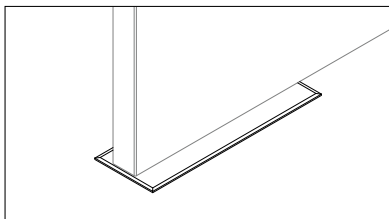

**01 a pavimento**  
*per anta cieca*

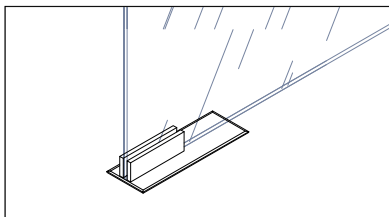

**02 a pavimento**  
*per anta in vetro temperato*

## Cerniere in alluminio

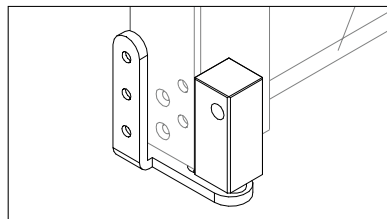

**01 a bilico esterno**  
*per anta cieca/intelaiata*

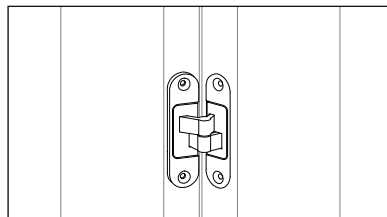

**02 a scomparsa**  
*per anta cieca/intelaiata*

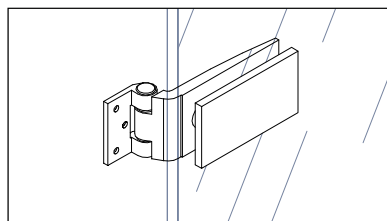

**03 apertura 180°**  
*per anta in vetro temperato*

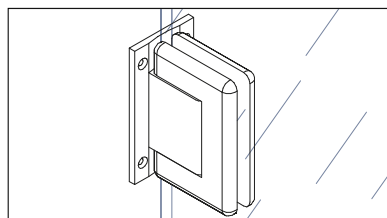

**04 va e vieni velocità regolabile**  
*per anta in vetro temperato*

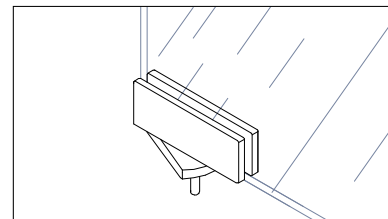

**05 va e vieni velocità regolabile**  
*per anta in vetro temperato*

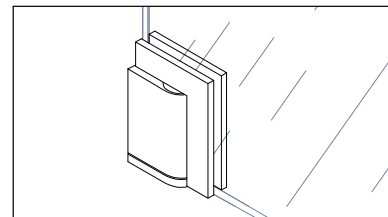

**06 va e vieni velocità regolabile**  
*per anta in vetro temperato*

## Accessori

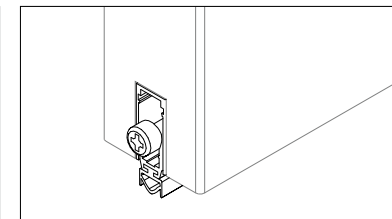

**01 antispiffero insonorizzante**  
*per anta cieca/intelaiata*

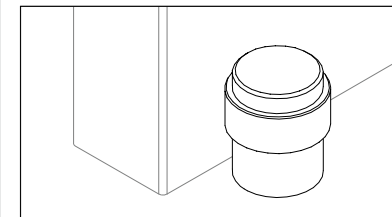

**02 fermaporte**  
*per anta cieca/intelaiata/vetro temperato*

**UNICA®**

Finiture

---



**Anodizzati**



**01** Alluminio naturale

**Finiture RAL**



**01** Bianco



**02** Bronzo

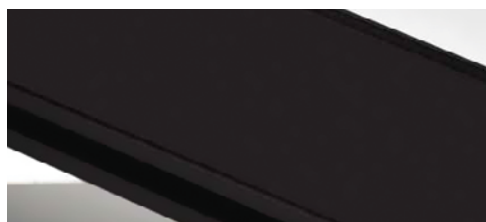

**02** Nero

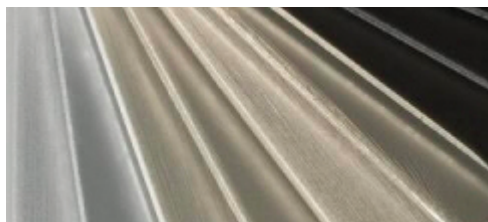

**03** Colore a campione



**03** Colore a campione

**Lucidatura**



**01** Brillantato

**Legni**



**01** Rovere chiaro

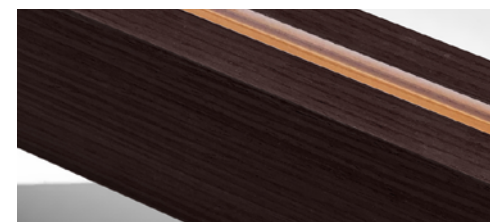

**02** Rovere scuro

# Pannelli ciechi



CAT. 1

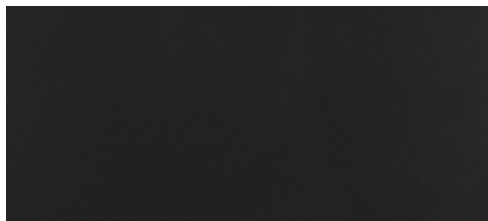

**055** Nero grafite

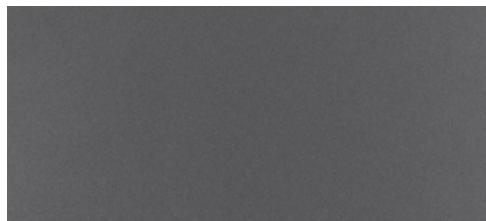

**420** Piombo



**418** Grigio cenere

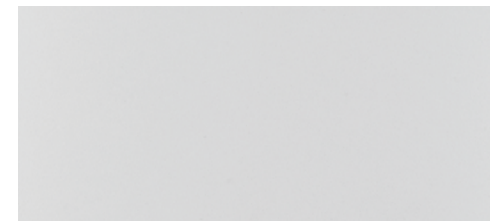

**419** Grigio chiaro

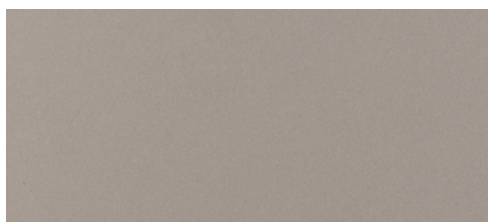

**393** Tortora



**417** Vaniglia

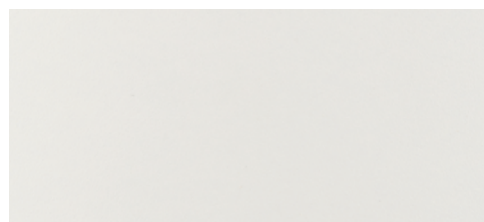

**429** Bianco caldo

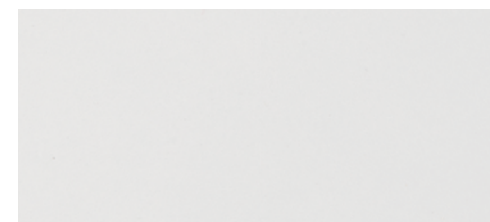

**428** Bianco freddo

CAT. 2



**422** Argento

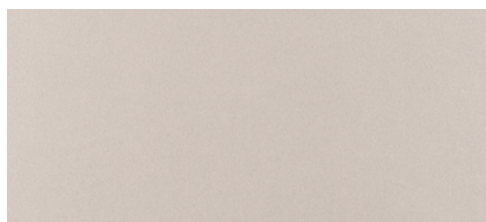

**423** Champagne





CAT. 1

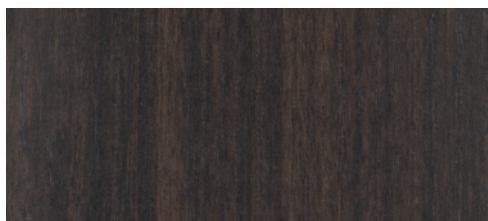

**421** Eucalipto

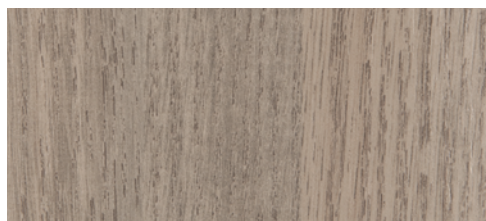

**426** Rovere medio



**274** Acacia



**416** Bianco venato

CAT. 2

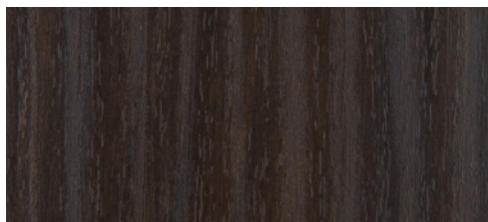

**425** Noce scuro

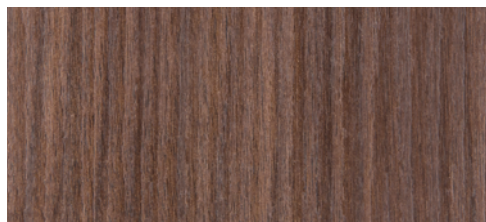

**318** Noce medio

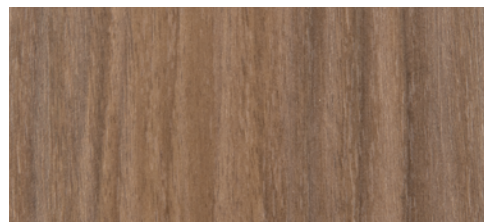

**427** Noce chiaro

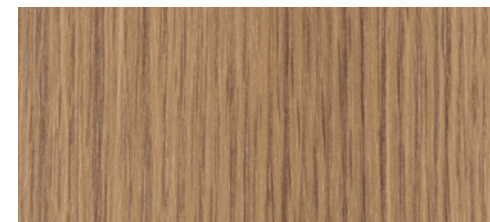

**382** Rovere naturale

CAT. 3



**138** Rovere invecchiato - taglio seta

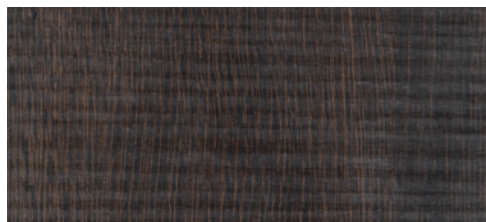

**197** Eucalipto - taglio seta

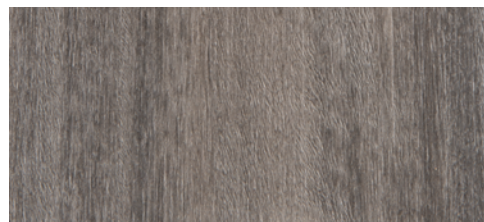

**408** Rovere grigio

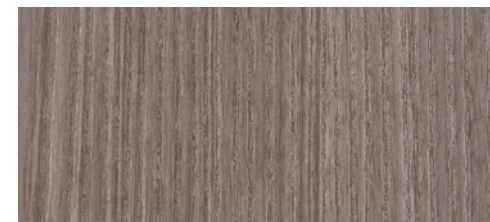

**400** Rovere Danubio

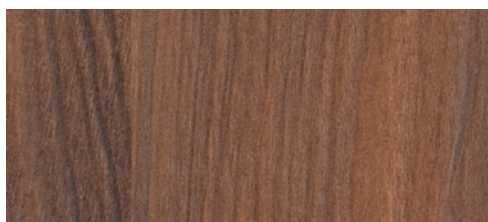

**414** Noce rosso

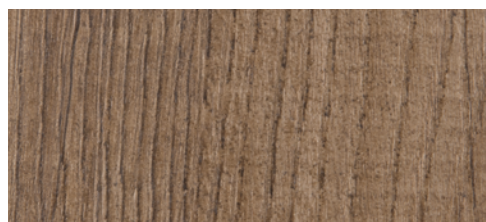

**412** Rovere vintage



**413** Rovere champagne



**410** Rovere chiaro



CAT. 2

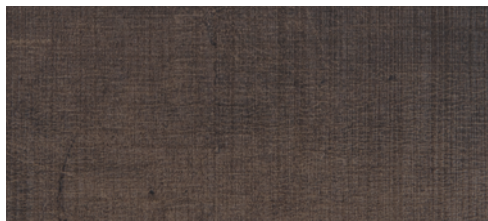

**304** Tessuto scuro



**123** Tessuto medio

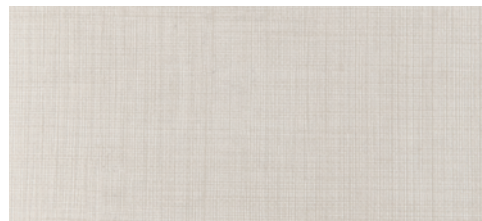

**305** Tessuto chiaro



**424** Ossido

CAT. 3

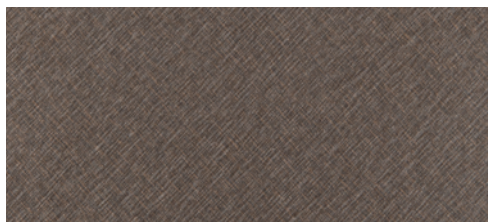

**385** Lino bronzo

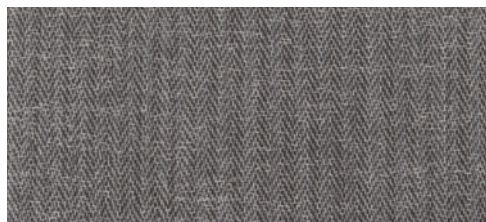

**409** Corteccia

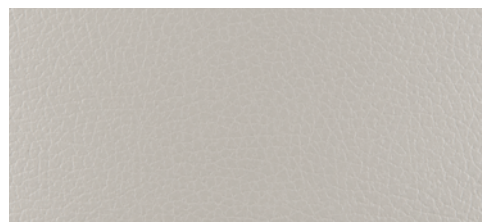

**406** Primo fiore grigio

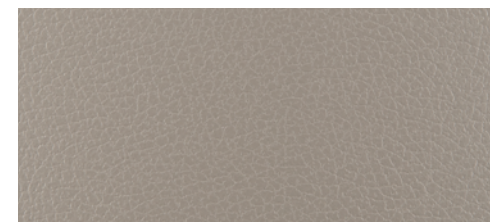

**405** Primo fiore tortora



**404** Primo fiore beige

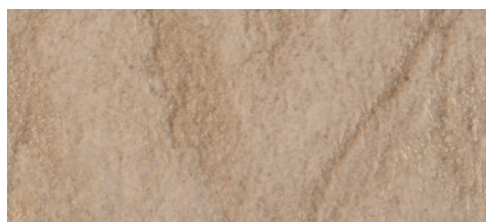

**415** Deserto





**01** Trasparente



**03** Satinato

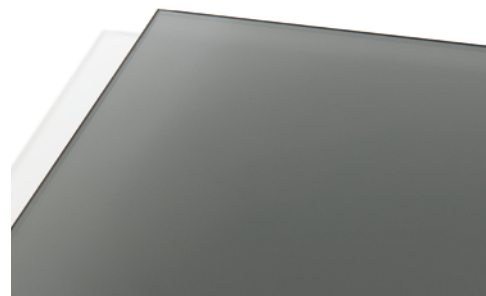

**05** Fumé



**02** Extrachiaro

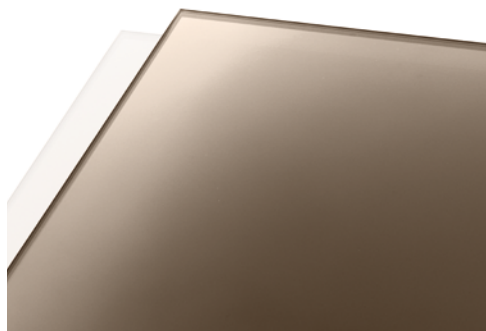

**04** Bronzo



**06** Verniciato a campione

**UNICA®**

Capitolato tecnico

---





**UNICA®** è una parete interna mobile monovetro e doppiovetro, con spessore nominale **51 mm**, con sola funzione di separazione, fornita in **sette soluzioni** formalmente diverse.

### **VERSIONI**

#### **UNICA® SLIM**

Guida a sezione rettangolare - L.30 mm x H.25 mm e superiore 36 mm, vetro singolo sp. 55.1/66.1 o temperato 10/12 mm

#### **UNICA® U**

Guida a sezione rettangolare - L.30 mm x H.50 mm, vetro singolo sp. 55.1/55.2 o temperato 10 mm

#### **UNICA® SC1**

Guida a sezione rettangolare - L.47 mm x H.40 mm, vetro singolo sp. 66.1/66.2 o temperato 12 mm

#### **UNICA® SC2**

Guida a sezione rettangolare - L.47 mm x H.40 mm, vetro singolo sp. 88.1/88.2 o temperato 16 mm

#### **UNICA® SC3**

Guida a sezione rettangolare - L.47 mm x H.40 mm, vetro singolo sp. 55.1/55.2 o temperato 10 mm

#### **UNICA® R**

Guida a sezione a T - L.47 mm x H.60 mm, vetro singolo sp. 55.1/55.2 o temperato 10 mm

#### **UNICA® D**

Guida a sezione rettangolare - L.47 mm x H.60 mm, vetro doppio sp. 55.1/55.2 o temperato 10 mm

### **DESCRIZIONE GENERALE**

La parete, di spessore totale 51 mm, è costituita da una struttura in **estrusi di lega di alluminio 6060 UNI 9006/1** (guide a pavimento e soffitto, montanti, partenze a muro) predisposta per accogliere pannelli di chiusura in cristallo di sicurezza, pannelli speciali in vetro e legno prodotti in esclusiva e brevettati, e pannelli completamente ciechi o altri materiali monolitici a richiesta del Cliente.

Le **guide** a pavimento e soffitto ed i profili a muro consentono il perfetto livellamento della parete sia in orizzontale che in verticale e la perfetta chiusura contro i paramenti murari esistenti.



La corretta **connessione** tra i profili guida, in incroci a due o tre vie, è assicurata da raccordi angolari in alluminio, ancorati meccanicamente.

Il sistema è dotato di **profili verticali d'angolo**, fissi e variabili, ed **intermedi** in alluminio la cui funzionalità è quella di aumentare la resistenza meccanica dei pannelli nei punti di giunzione e migliorarne la chiusura.

A questi raccordi si aggiungono elementi di **connessione lineare**, a due e a tre vie in polycarbonato.

Le **porte**, disponibili nella tipologia a battente o scorrevole esterna, possono essere fornite sia ad altezza standard sia ad altezza di parete. Entrambe le tipologie sono previste ad anta singola e doppia.

Il **tipo a battente** può avere l'anta in legno, in vetro intelaiato singolo e doppio, e solo in vetro. La versione intelaiata permette l'alloggiamento di chiudiporta superiori ad incasso e ghigliottine acustiche inferiori; quella vetrata permette unicamente l'installazione del chiudiporta esterno.

Il **tipo scorrevole** è realizzabile in legno, in vetro intelaiato singolo o solo vetro filo lucido. Il corretto scorrimento è garantito da carrelli con ammortizzatore di chiusura ed apertura delle ante.

L'**anta in legno tamburato**, spessore 43 mm, è realizzata con struttura interna a nido d'ape inserita in un telaio perimetrale in legno di abete e pannelli fibrolegnosi sui due lati e rifinita con laminato HPL bordato in ABS, sp=10/10 mm.

L'**anta in vetro intelaiata**, perimetralmente presenta profili estrusi in lega di alluminio 6060 UNI 9006/1, di larghezza differenziata, e lastra interna in vetro temperato o stratificato (3+3 mm), con finitura trasparente o acidata.

Nelle ante in legno o con vetro intelaiato, le cerniere previste sono: esterne a bilico, con apertura a 180°; a scomparsa nel telaio, regolabili su tre assi, con apertura a 180°.

L'**anta in vetro** è costituita da una lastra temperata, con finitura trasparente o acidata, di spessore 10 mm.

Le cerniere previste nelle ante filo lucido sono: pressofuse in alluminio con apertura a 110° o 180°; a bilico, in alluminio e acciaio, con apertura a 180°; lineari, in alluminio e acciaio, con apertura a 180°.

Gli **stipiti** delle porte ed i montanti, sono realizzati in profili estrusi di alluminio a "cannocchiale" con guarnizioni di battuta in PVC, in colore grigio RAL 9006, e permettono l'alloggiamento di eventuali cavi elettrici e l'inserimento di punti di comando a frutto singolo.

In corrispondenza del punto di battuta della serratura, sono previsti controbordi in acciaio incassati nel telaio di alluminio, che garantiscono precisione di chiusura dello scrocco ed estrema robustezza.



Per consentire un adeguato **cablaggio** della parete, è previsto un **modulo tecnico** apribile in alluminio estruso (sp=51 mm) studiato per favorire l'installazione di punti luce, punti presa, termostati, sensori di allarmi ed altre apparecchiature dimensionalmente compatibili.

Le porte sono dotate di una ricca **gamma di maniglie** di serie che può essere ulteriormente incrementata grazie all'impiego di serrature con piastra universale adatte anche all'installazione di articoli fuori catalogo.

La parete è perfettamente **integrabile** con la versione a contenitore Quadra.



### **UNICA SC3**

**01.** Parete vetro singolo (stratificato 5+5+pvb 0,38) - Prova Meccanica -  
**Certificato n. 287871 IT/EN - UNI 8201:1981 secondo il D.M. infrastrutture del 14/01/2008**

### **UNICA SC1**

**01.** Parete vetro singolo 66.1 (stratificato 6+6+pvb 0,38) - Prova Acustica -  
**Certificato n. 355037 IT/EN - UNI EN ISO 10140-2:2010 ed UNI EN ISO 717-1:2013**

**02.** Parete vetro singolo 66.2a (stratificato 6+6+pvb 0,76+pellicola acustica) - Prova Acustica -  
**Certificato n. 355038 IT/EN - UNI EN ISO 10140-2:2010 ed UNI EN ISO 717-1:2013**

**03.** Parete vetro singolo (stratificato 6+6+pvb 0,38) - Prova Meccanica -  
**Certificato n. 356911 IT/EN - GUIDA ETAG 003:2012 e norma UNI ISO 7892:1990**

### **UNICA SC2**

**01.** Parete vetro singolo 88.1 (stratificato 8+8+pvb 0,38) - Prova Acustica -  
**Certificato n. 355039 IT/EN - UNI EN ISO 10140-2:2010 ed UNI EN ISO 717-1:2013**

**02.** Parete vetro singolo 88.2a (stratificato 8+8+pvb 0,76+pellicola acustica) - Prova Acustica -  
**Certificato n. 355040 IT/EN - UNI EN ISO 10140-2:2010 ed UNI EN ISO 717-1:2013**

**03.** Parete vetro singolo (stratificato 8+8+pvb 0,38) - Prova Meccanica -  
**Certificato n. 356910 IT/EN - GUIDA ETAG 003:2012 e norma UNI ISO 7892:1990**



**01.** Parete vetro singolo (stratificato 5+5+pvb 0,38) - Prova Acustica -  
**Certificato n. 243251 IT/EN - UNI EN ISO 140-3:2006 ed UNI EN ISO 717-1:2007**

**02.** Parete con modulo cieco - Prova Acustica -  
**Certificato n. 243249 IT/EN - UNI EN ISO 140-3:2006 ed UNI EN ISO 717-1:2007**

**03.** Parete vetro singolo (stratificato 5+5+pvb 0,50) - Prova Acustica -  
**Certificato n. 256187 IT/EN - UNI EN ISO 140-3:2006 ed UNI EN ISO 717-1:2007**

**04.** Parete vetro singolo (vetro 5+5+pvb 0,38) - Prova Meccanica -  
**Certificato n. 242460 IT/EN - UNI 8201:1981**

**05.** Parete con modulo cieco - Prova Meccanica -  
**Certificato n. 242461 IT/EN - UNI 8201:1981**



**01.** Parete vetro doppio (stratificato 5+5+pvb 0,38) - Prova Acustica -  
**Certificato n. 243250 IT/EN - UNI EN ISO 140-3:2006 ed UNI EN ISO 717-1:2007**

**02.** Parete vetro doppio (stratificato 5+5+pvb 0,50+pellicola acustica) - Prova Acustica -  
**Certificato n. 248051 IT/EN - UNI EN ISO 140-3: 2006 ed UNI EN ISO 717-1:2007**

**03.** Parete vetro doppio (stratificato 5+5+pvb 0,38) - Prova Meccanica -  
**Certificato n. 242467 IT/EN - UNI 8201:1981**



**01.** Porta in legno - Prova Acustica -

**Certificato n. 243518 IT/EN - UNI EN ISO 140-3:2006 ed UNI EN ISO 717-1:2007**

**02.** Porta in vetro temperato 10 mm - Prova Acustica -

**Certificato n. 243519 IT/EN - UNI EN ISO 140-3:2006 ed UNI EN ISO 717-1:2007**

**03.** Porta a battente intelaiata grande, vetro stratificato 6/7 intelaiato - Prova Acustica -

**Certificato n. 243517 IT/EN - UNI EN ISO 140-3:2006 ed UNI EN ISO 717-1:2007**

**04.** Porta a battente intelaiata sottile, vetro singolo centrale 6 mm - Prova Acustica -

**Certificato n. 355042 IT/EN - UNI EN ISO 10140-2:2010 ed UNI EN ISO 717-1:2013**

**05.** Porta a battente intelaiata da 51 mm a doppio vetro 6 mm - Prova Acustica -

**Certificato n. 355043 IT/EN - UNI EN ISO 10140-2:2010 ed UNI EN ISO 717-1:2013**

**06.** Porta a battente intelaiata sottile, vetro singolo centrale 6 mm - Prova Meccanica -

**Certificato n. 356933 IT/EN - GUIDA ETAG 003:2012 e norma UNI ISO 7892:1990**

**07.** Porta a battente intelaiata da 51 mm a doppio vetro 6 mm - Prova Meccanica -

**Certificato n. 356932 IT/EN - GUIDA ETAG 003:2012 e norma UNI ISO 7892:1990**



**Etoile s.r.l. - Società Unipersonale**

Via D. Albertario, 50 61032 Zona Ind.le Bellocchi - Fano ( PU ) Italy  
P. +39.0721.85.59.34 - F. +39.0721.85.92.14  
info@etoilesrl.it - www.etoilesrl.it