



☐ ETOILE

RITMICA® WOOD D2





- 01.** Thickness: 92 mm
- 02.** Veneered laminated wood structure
- 03.** Wood slats are joined with the “finger joint” technique
- 04.** Floor profiles are in 6060 UNI 9006/1 extruded aluminium, concealed to ensure impermeability
- 05.** Double glass - 55.1 laminated glass or 10 mm thick tempered glass
- 06.** Fixed corner profiles
- 07.** Vertical junctions between glazed elements, made of wood, aluminium, polycarbonate or transparent two-sided tape
- 08.** Door frame with cable routing
- 09.** Utility module
- 10.** 5 versions of hinged doors - solid, tempered glass and framed
- 11.** 3 versions of external sliding doors - solid, tempered glass and framed

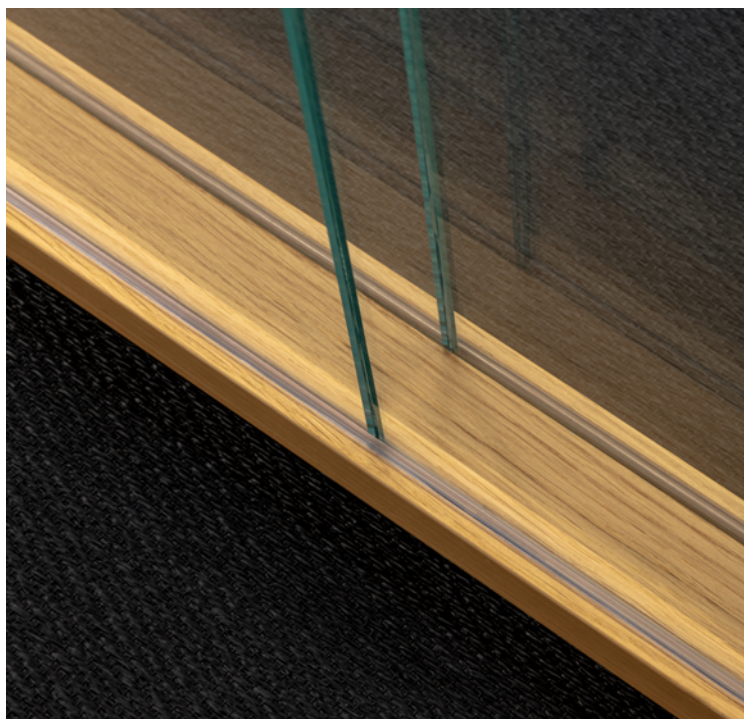

Wall-end uprights

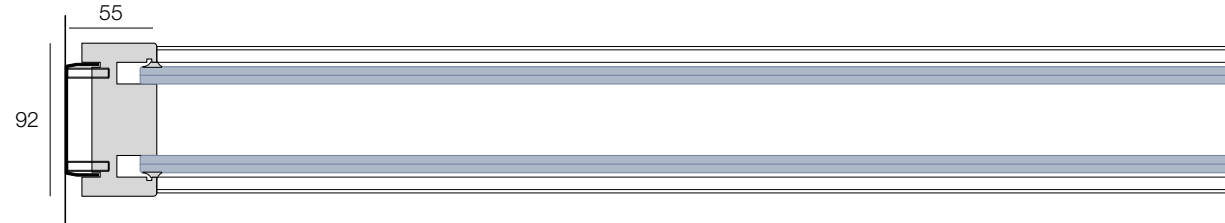
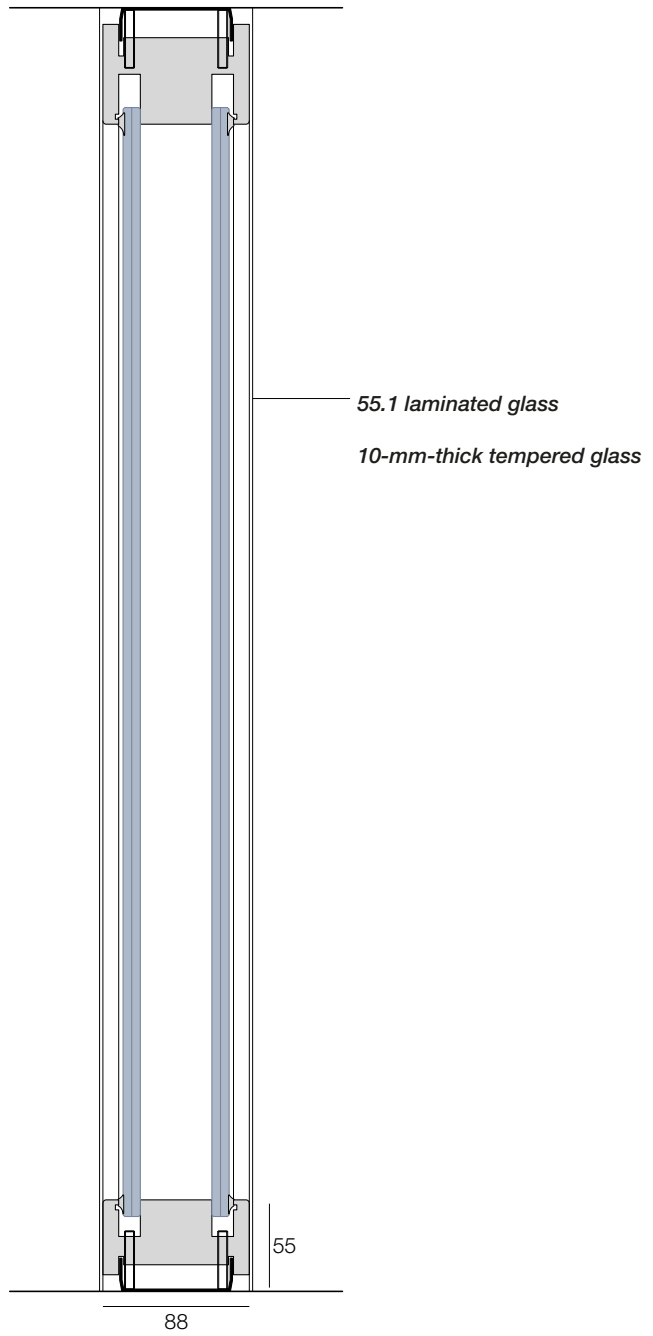

Fixed wall-end upright

Wall-end uprights

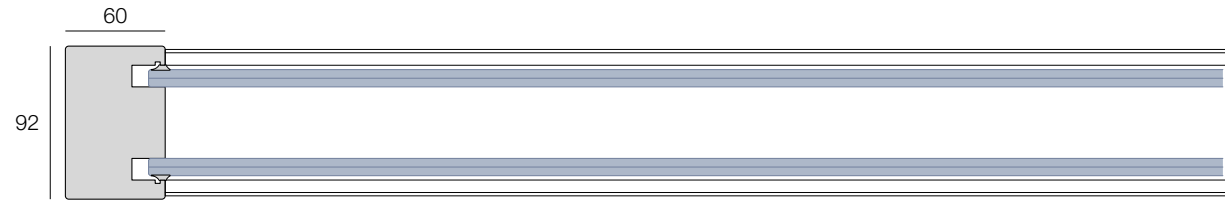

End profile

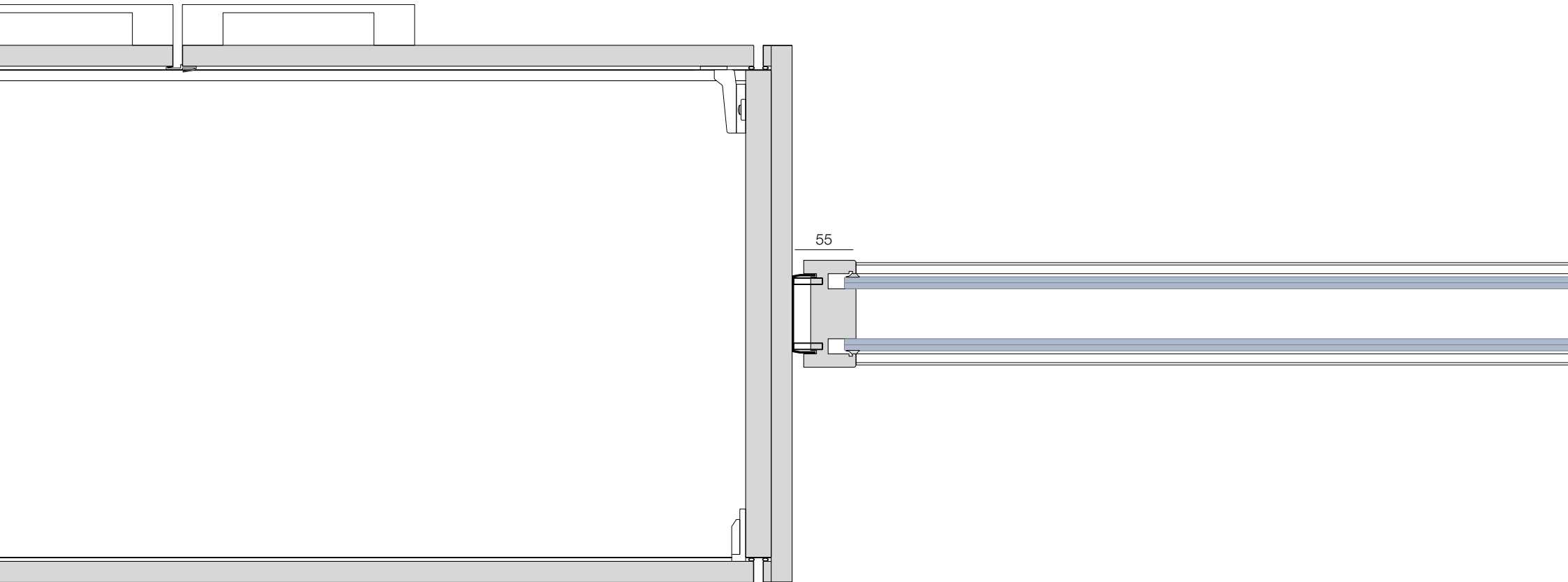

Storage-end upright

Junction profiles

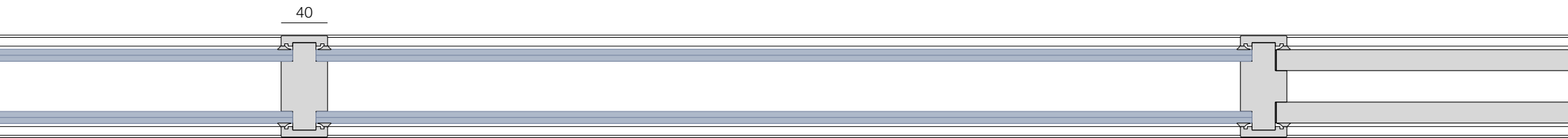

40

Junction

ritmica wood d2 - ritmica wood d2

Junction

ritmica wood d2 - ritmica wood solid

Junction profiles



variabile



**Polycarbonate
junction profile**



**Two-sided technical tape
junction**



**Two-sided technical tape
three-way junction**

Corner profiles

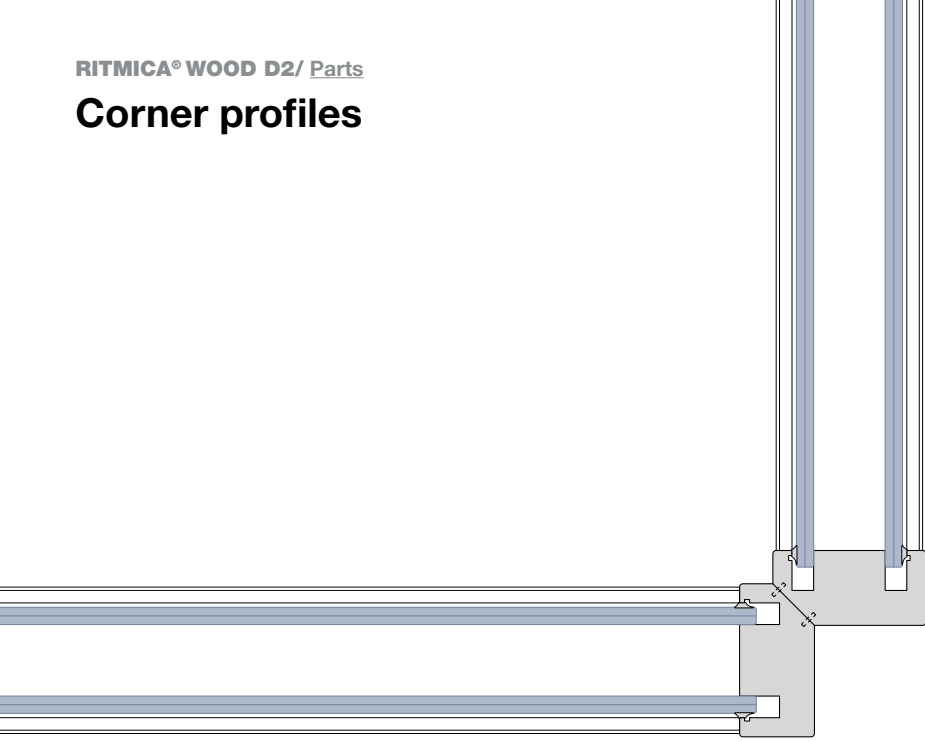

**Wooden
90° corner profile**



**Polycarbonate
90° corner profile**

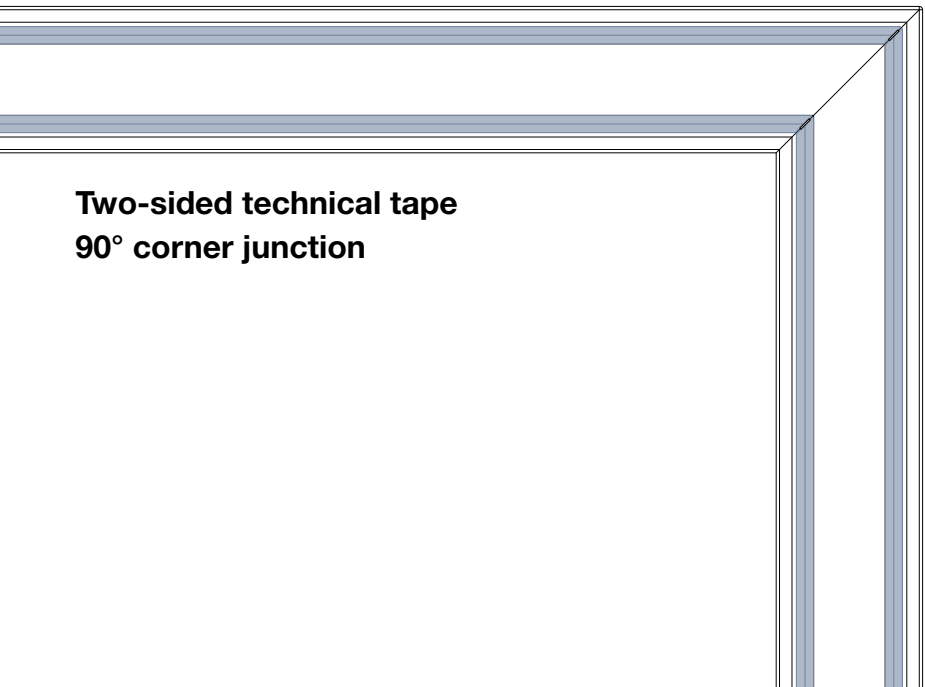

**Two-sided technical tape
90° corner junction**



Cabling and utility module for hinged doors



Utility module

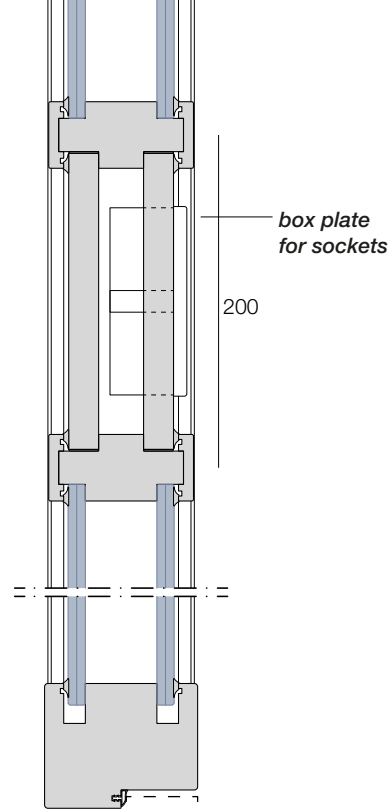

Cabling solution

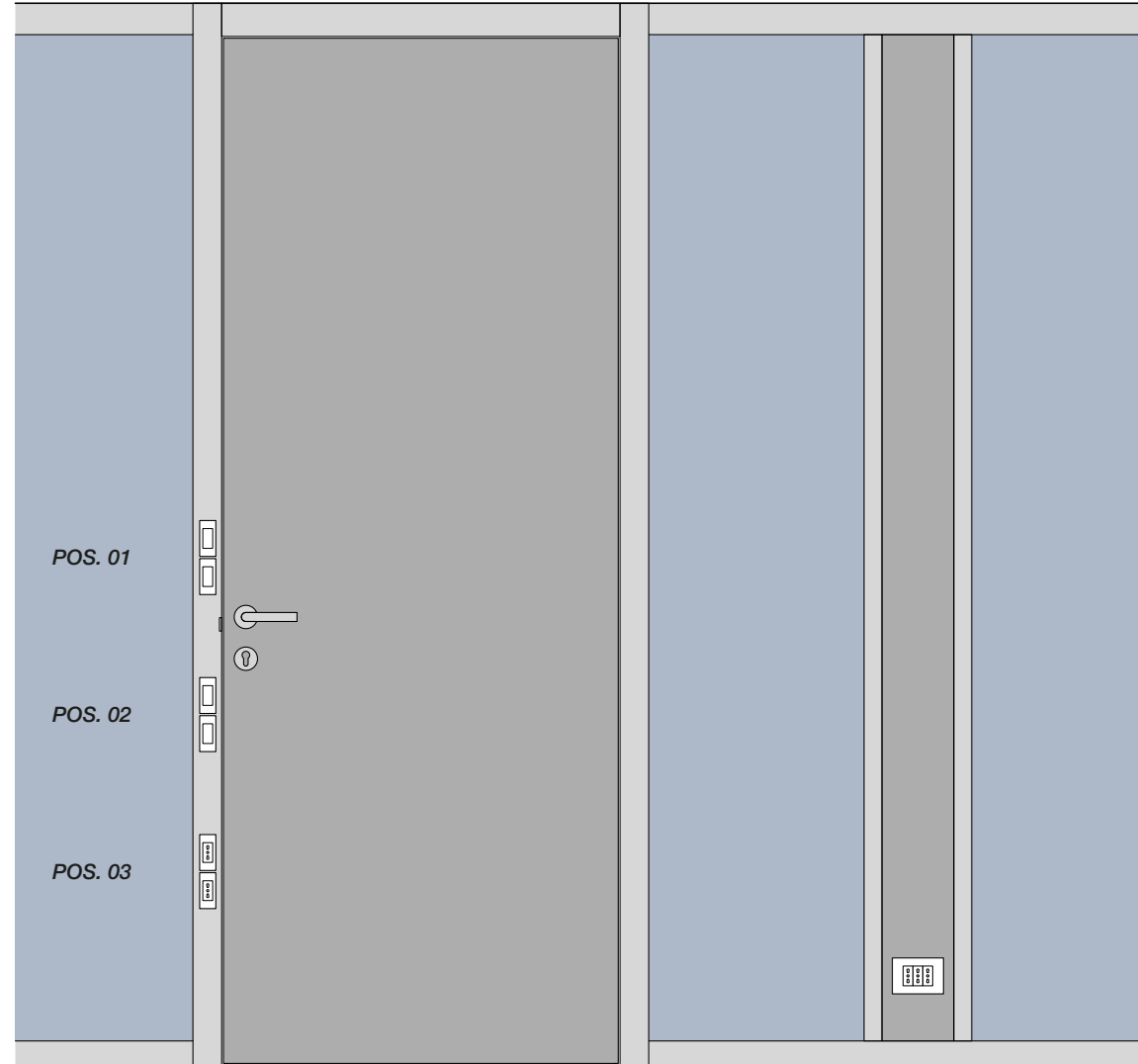
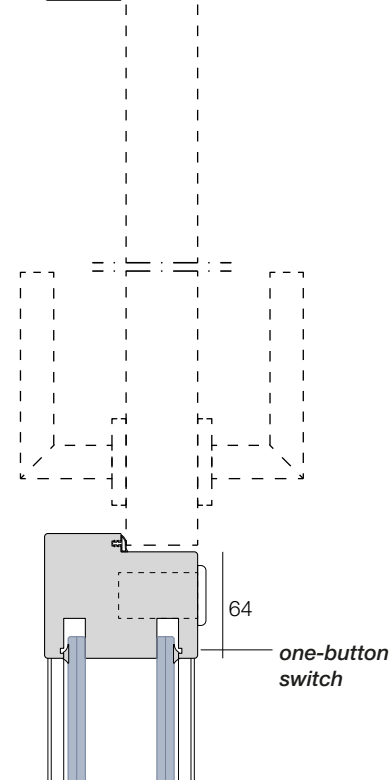

**possible positions for switches and sockets on the door frame*

Cabling and utility module for sliding doors



Utility module

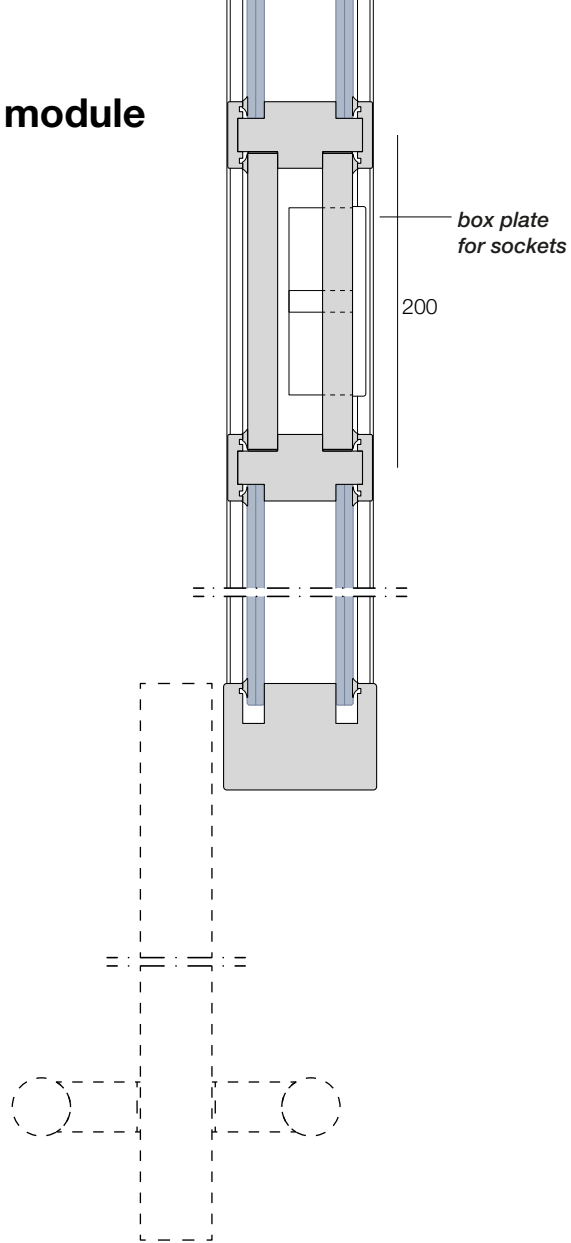

Cabling solution

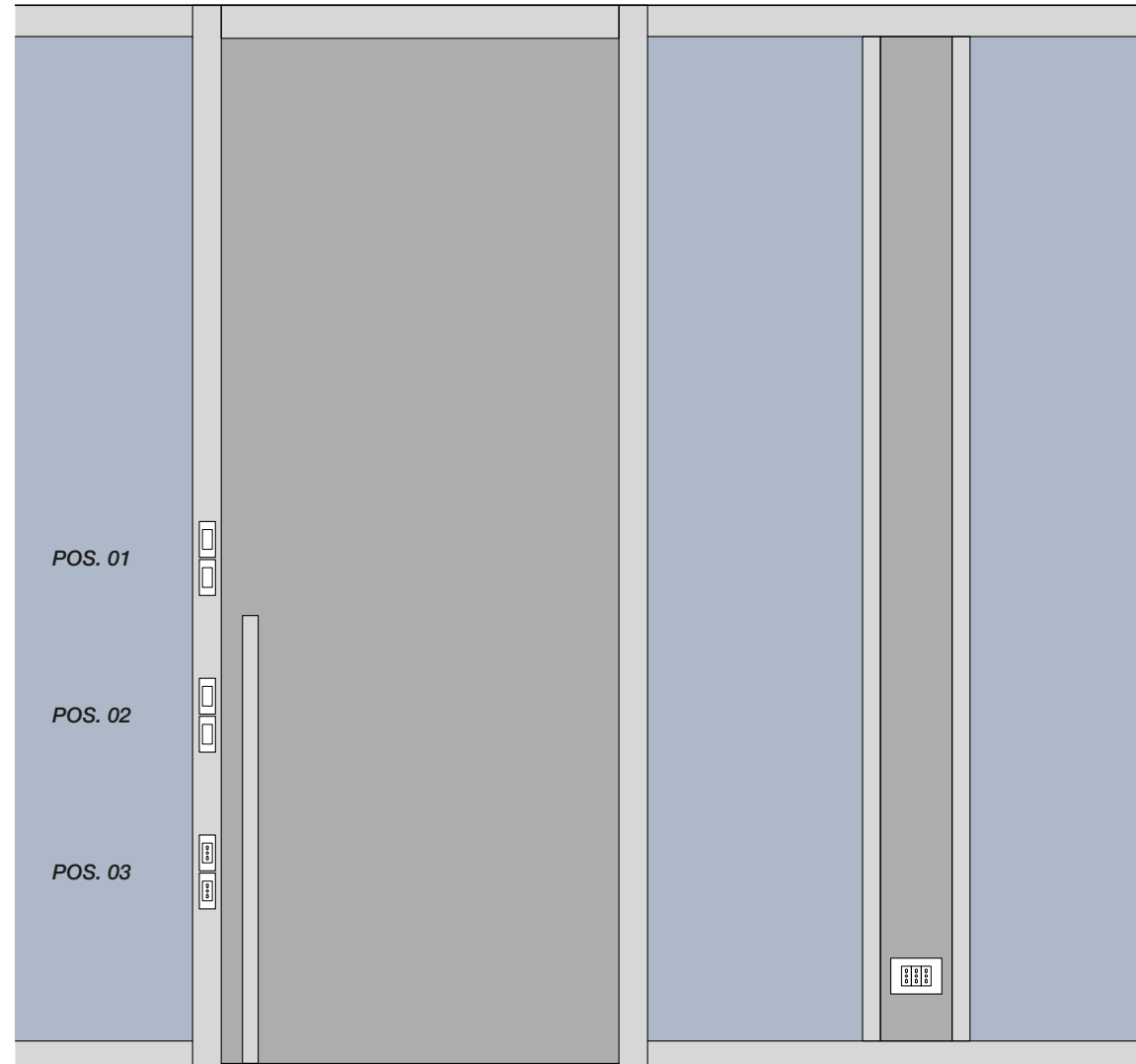
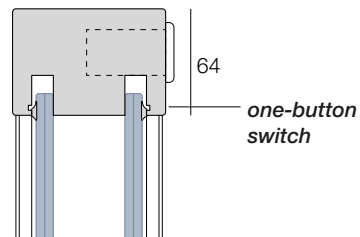

*possible positions for switches and sockets on the door frame

RITMICA®
WOOD

Doors and handles

FRAMES FOR HINGED DOORS



Door frame on **Ritmica Wood D1**

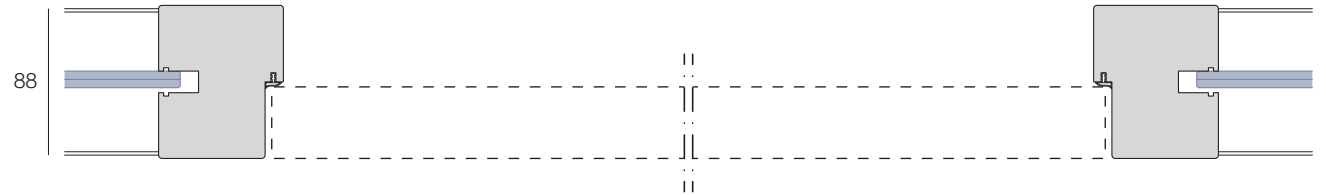

Door frame on **Ritmica Wood D2**

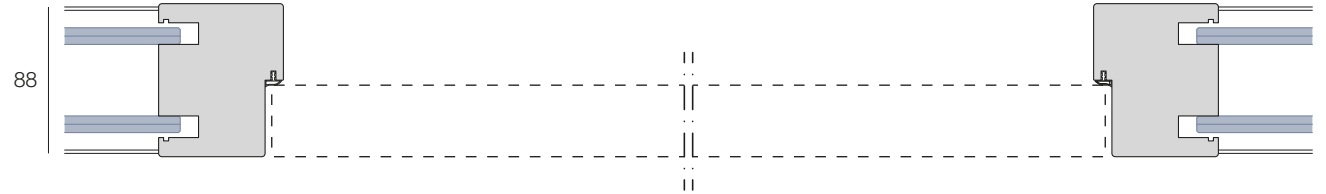

Door frame on **Ritmica Wood Solid**

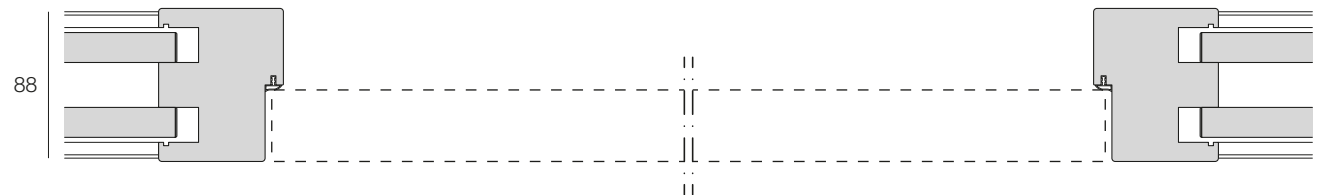

SOLID DOOR LEAF 43 mm thick

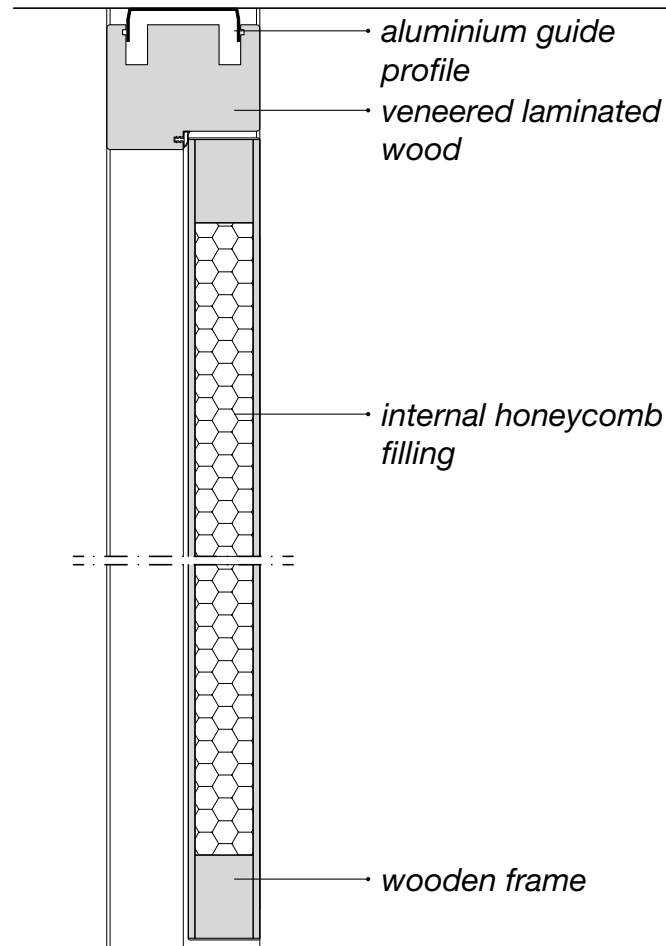

CHARACTERISTICS

- 01.** concealed hinge
- 02.** visible or concealed door closer
- 03.** switch on door upright
- 04.** recessed dust seal

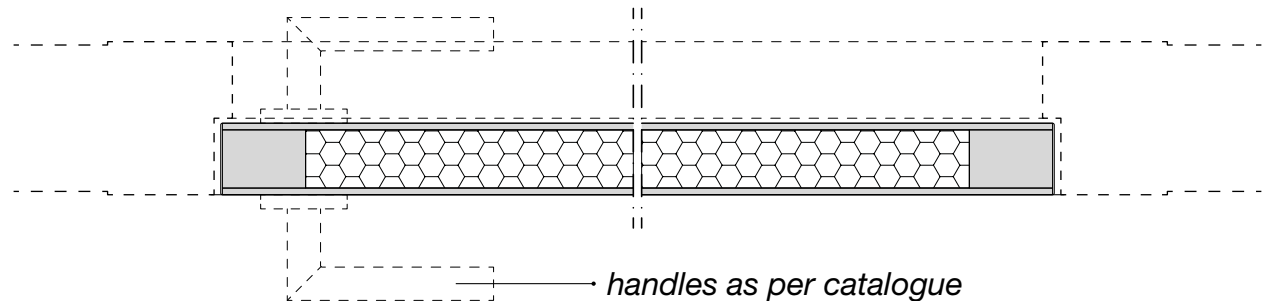

SOLID DOOR LEAF 43 mm thick

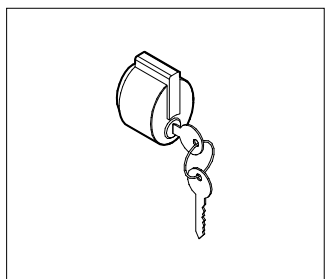

ML1

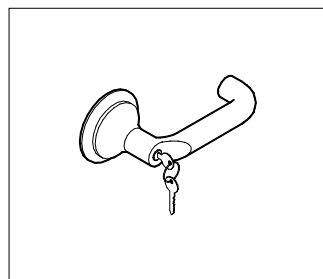

ML4

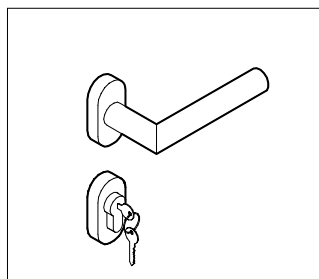

ML5

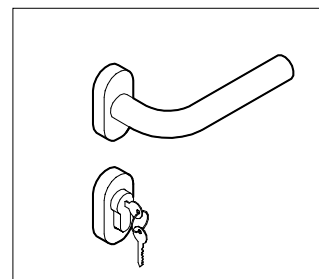

ML6

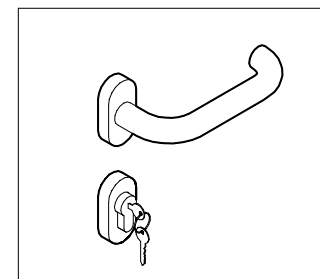

ML7

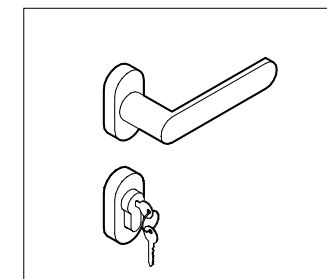

ML8

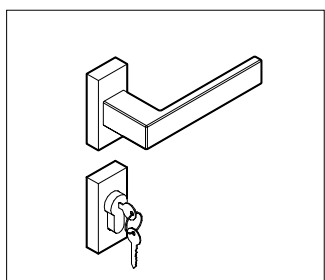

ML9

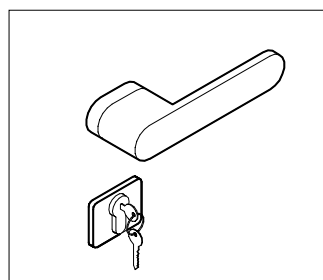

ML10

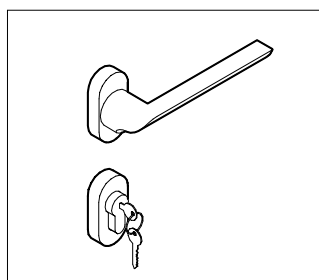

ML11

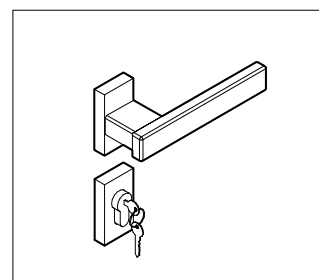

MLQ

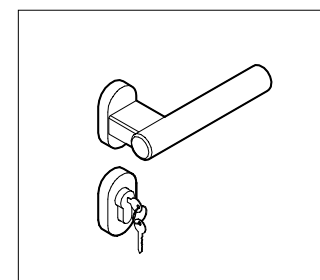

MLT

SOLID DOOR LEAF 92 mm thick

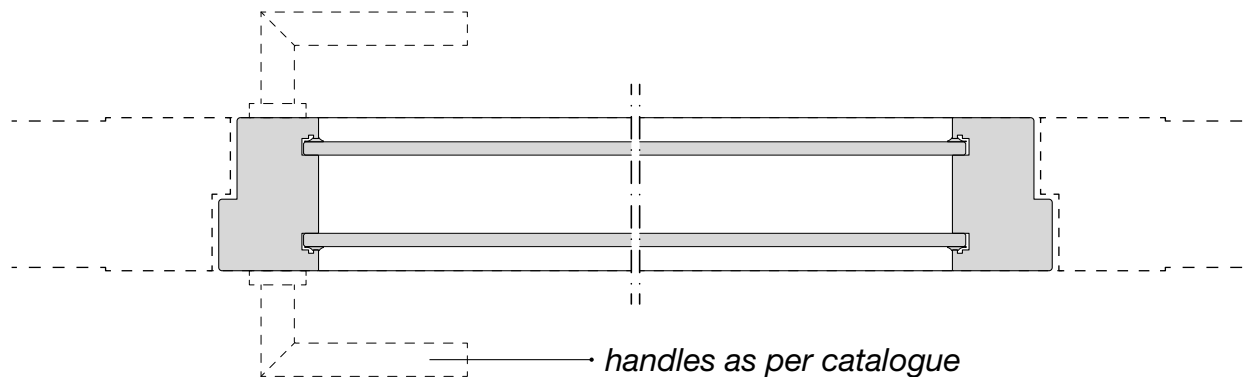
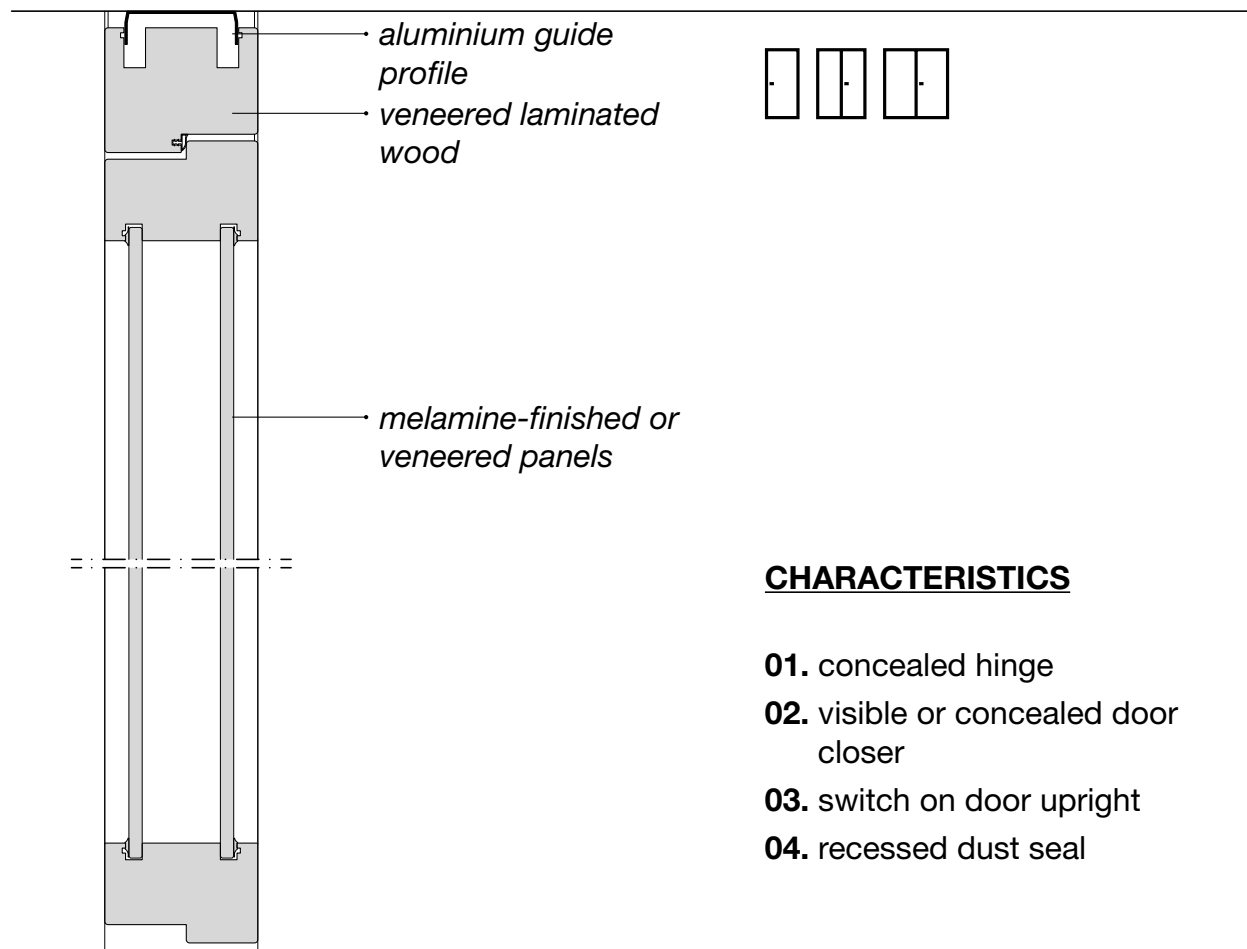

SOLID DOOR LEAF 92 mm thick

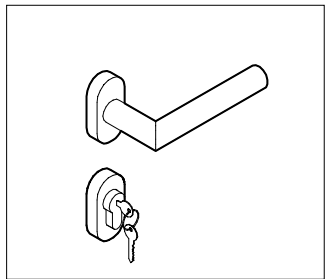

ML5

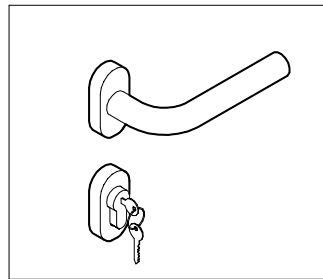

ML6

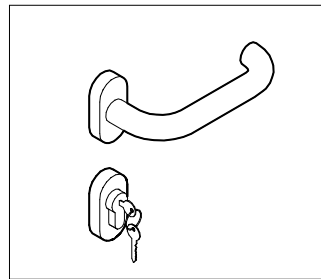

ML7

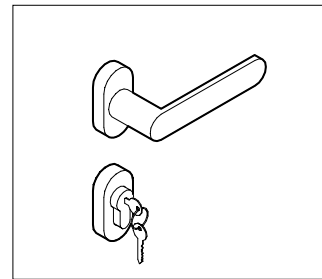

ML8

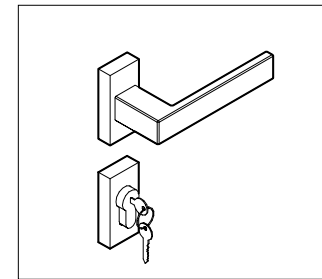

ML9

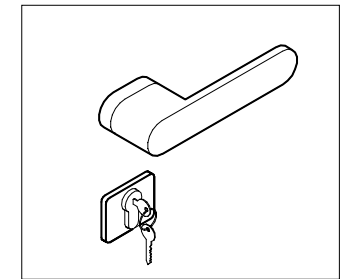

ML10

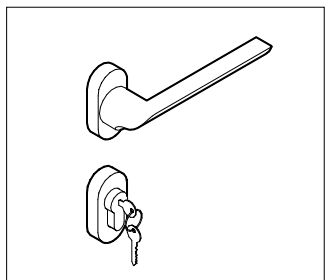

ML11

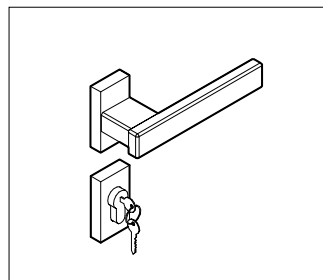

MLQ

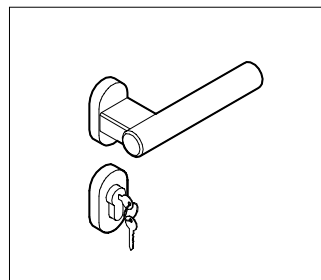

MLT

TEMPERED GLASS DOOR LEAF_FULL-HEIGHT HINGE 10 mm thick

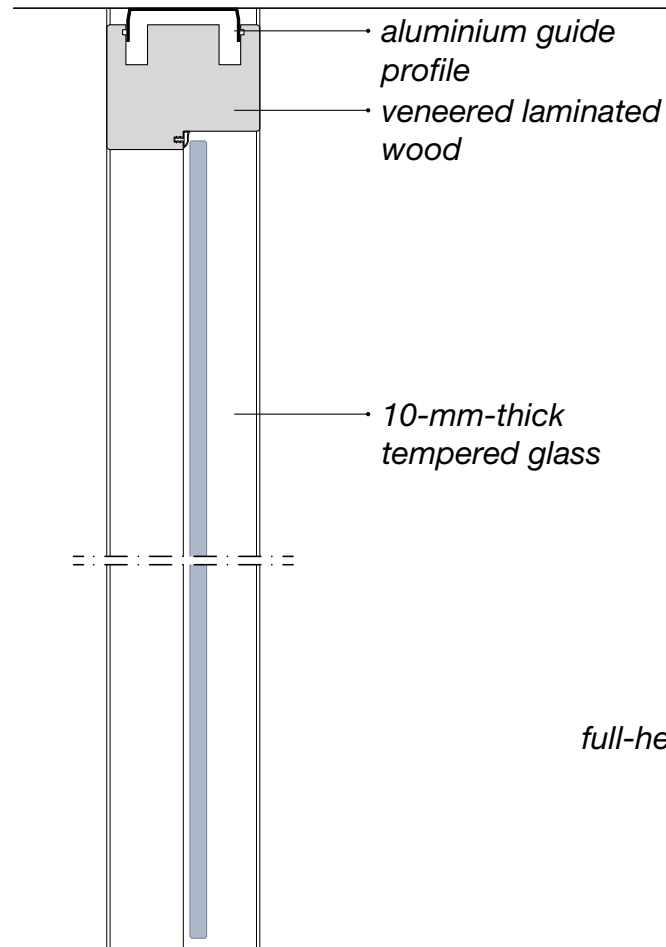

CHARACTERISTICS

- 01.** full-height hinge - 180°
- 02.** visible door closer
- 03.** handle with glass adapter
- 04.** switch on door upright
- 05.** external dust seal

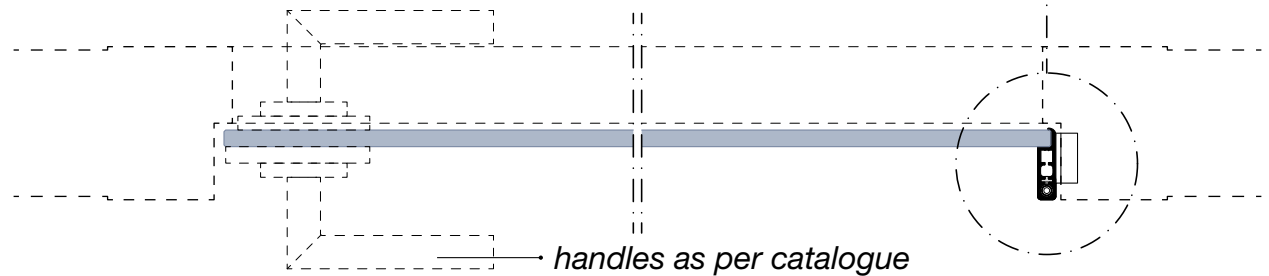
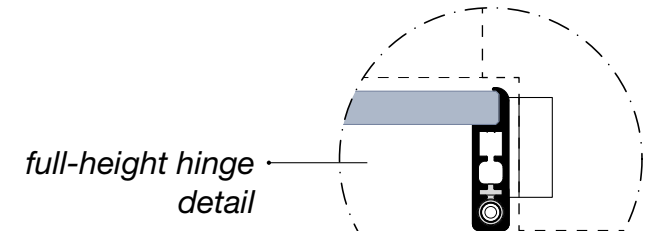

TEMPERED GLASS DOOR LEAF_FULL-HEIGHT HINGE 10 mm thick

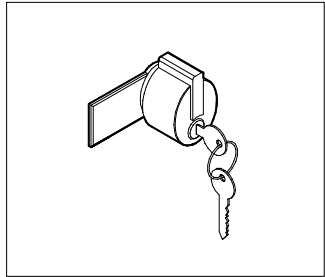

MC1

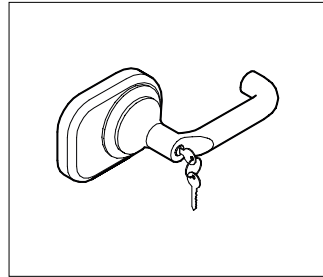

MC4

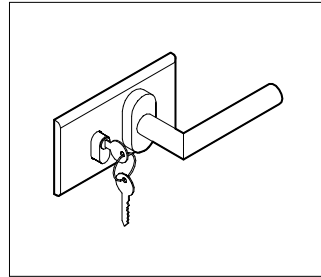

MC5

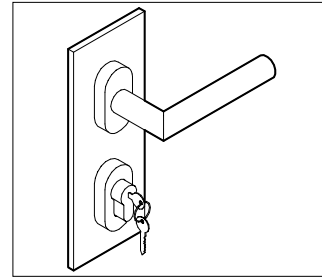

MC5V

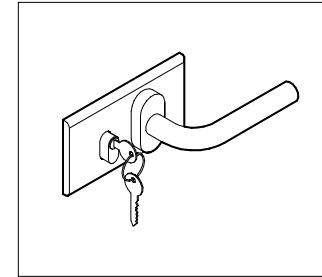

MC6

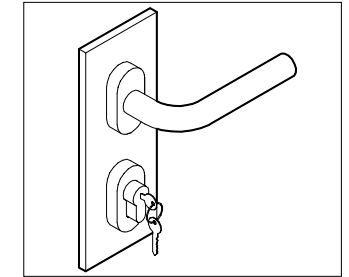

MC6V

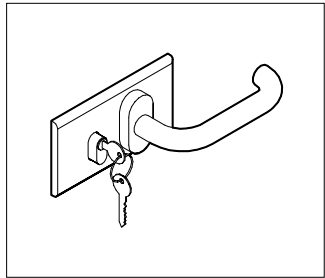

MC7

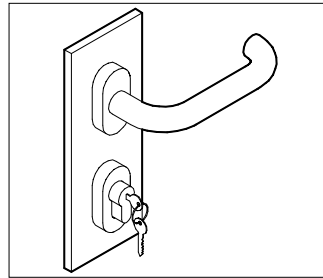

MC7V

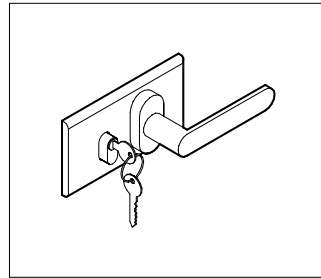

MC8

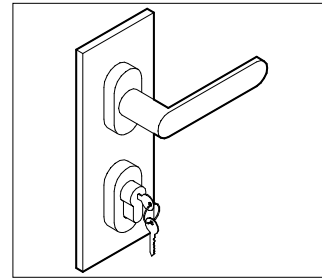

MC8V

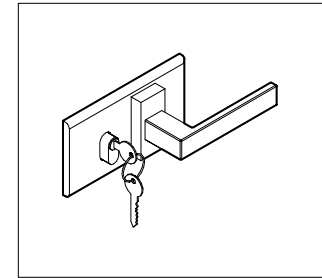

MC9

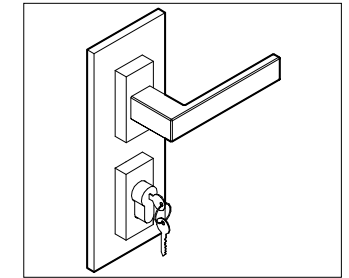

MC9V

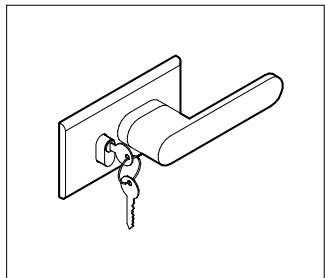

MC10

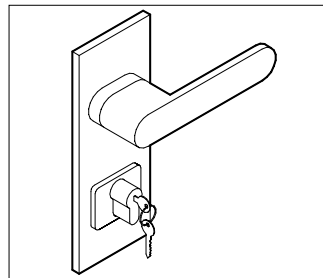

MC10V

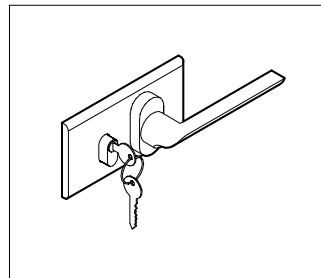

MC11

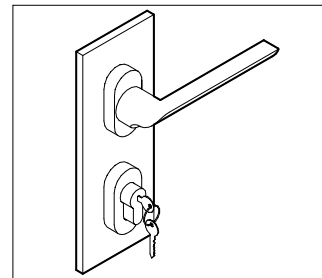

MC11V

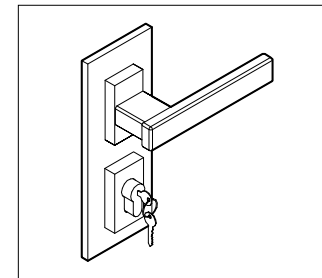

MCQ

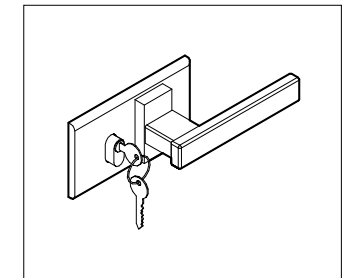

MCQO

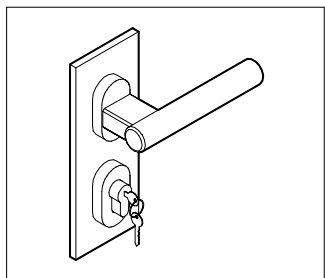

MCT

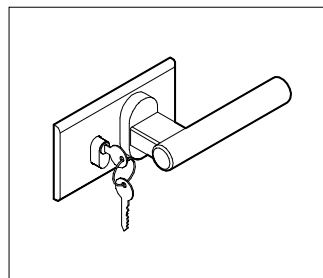

MCTO

FRAMED SINGLE-GLASS DOOR LEAF 43 mm thick

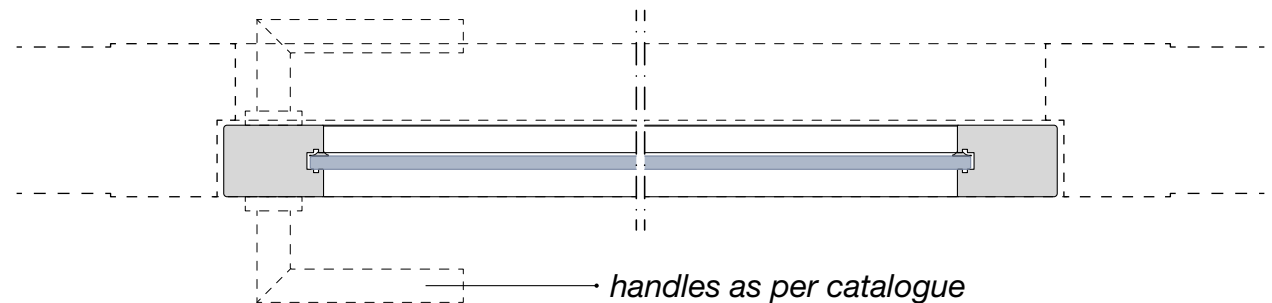
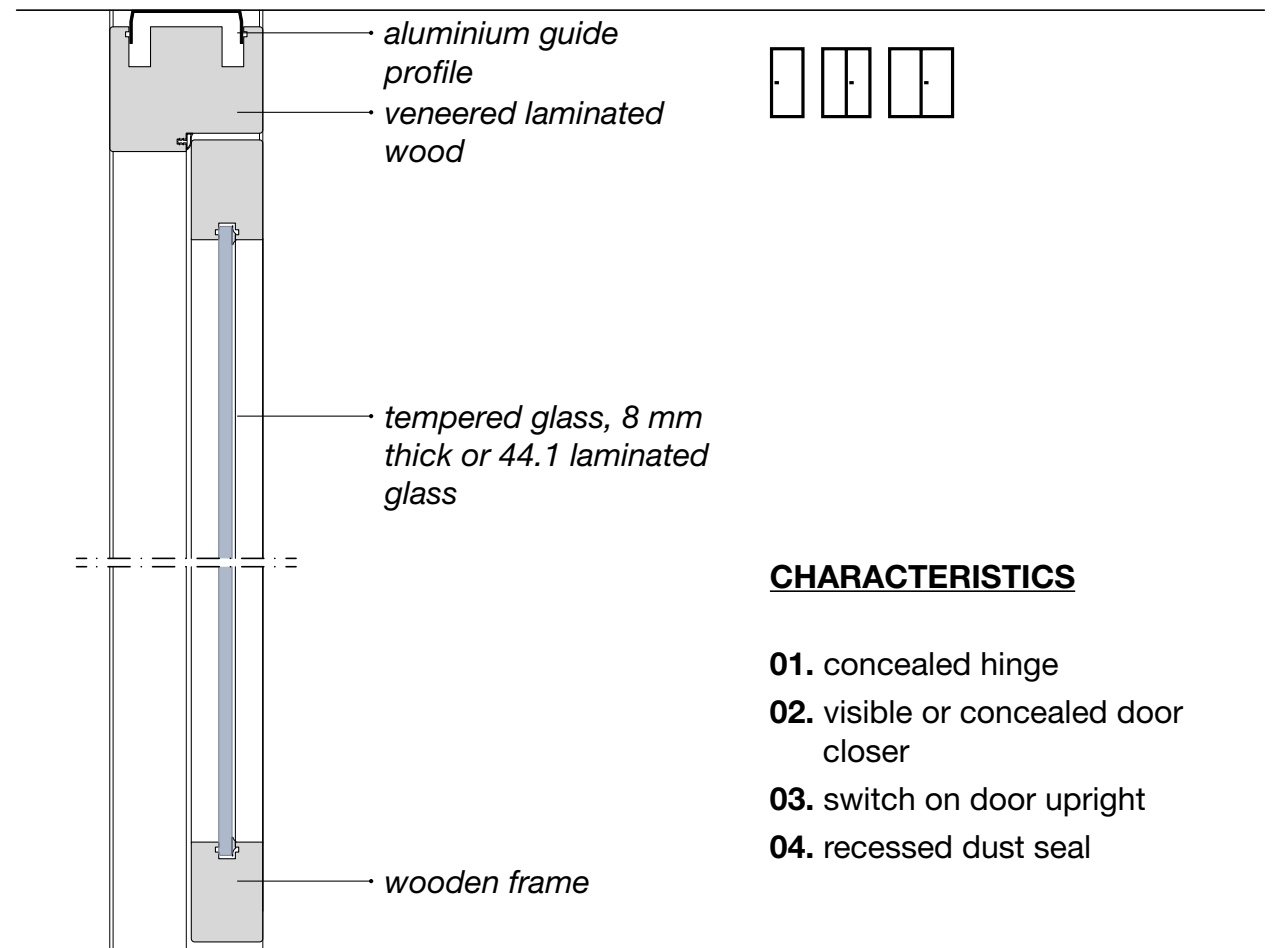

FRAMED SINGLE-GLASS DOOR LEAF 43 mm thick

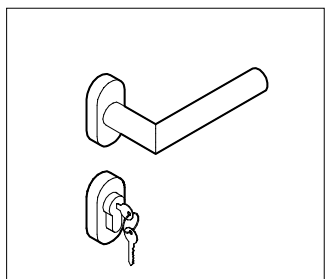

ML5

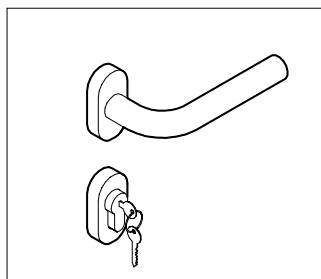

ML6

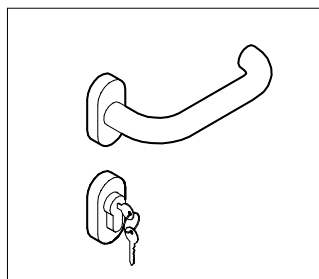

ML7

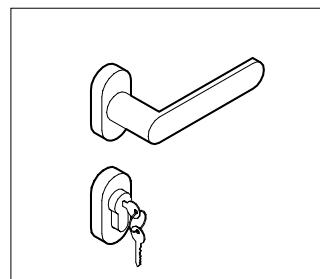

ML8

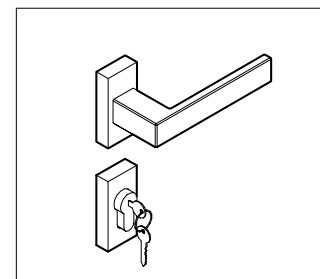

ML9

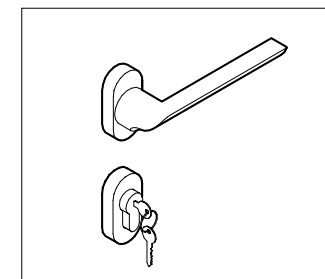

ML11

FRAMED DOUBLE-GLASS DOOR LEAF 92 mm thick

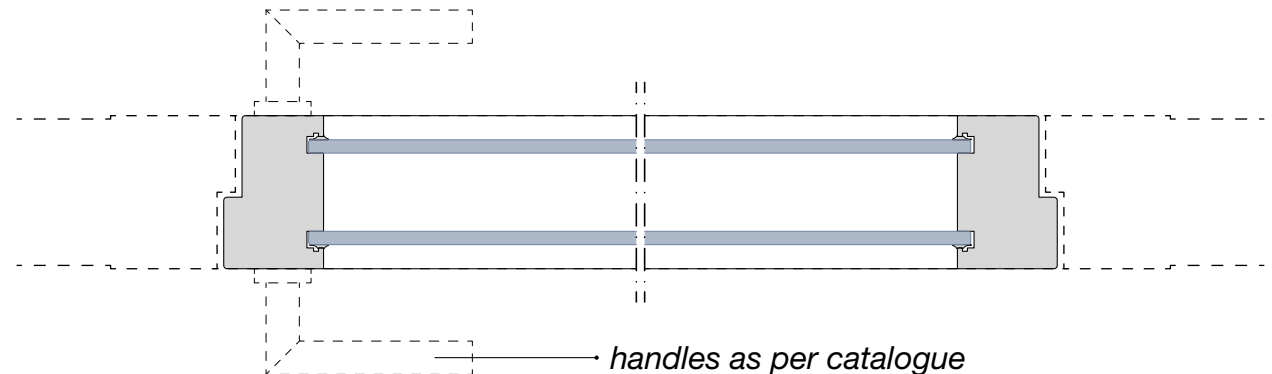
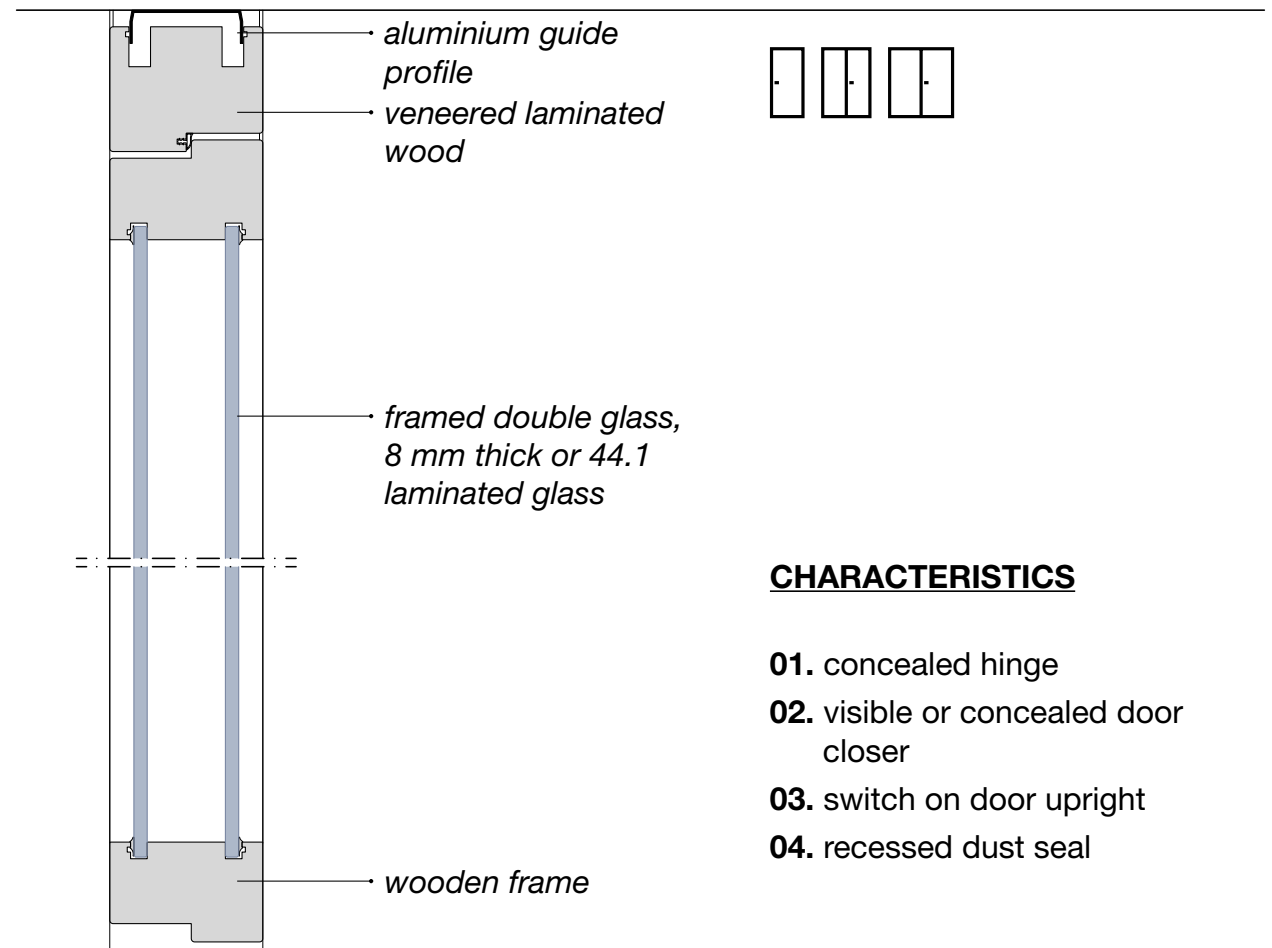

FRAMED DOUBLE-GLASS DOOR LEAF 92 mm thick

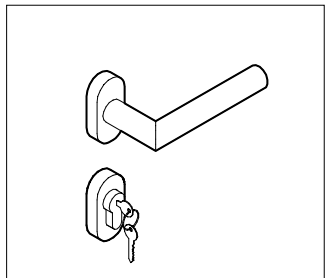

ML5

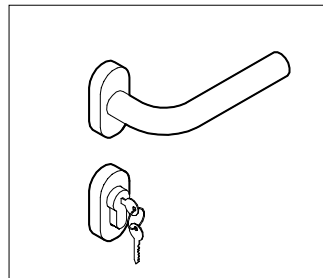

ML6

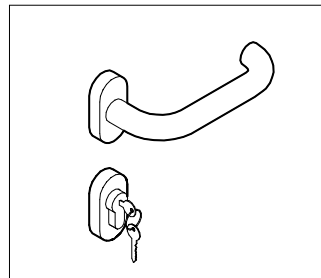

ML7

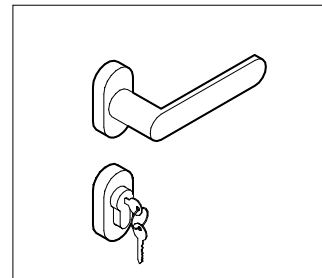

ML8

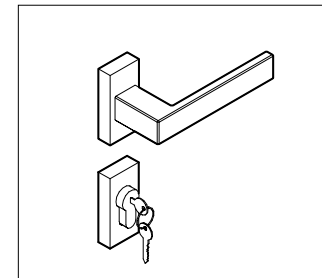

ML9

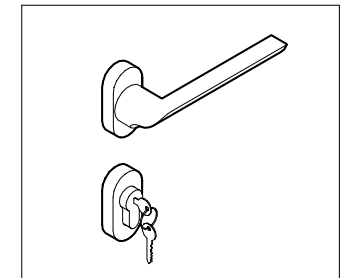

ML11

FRAMES FOR SLIDING DOORS



Door frame on **Ritmica Wood D1**

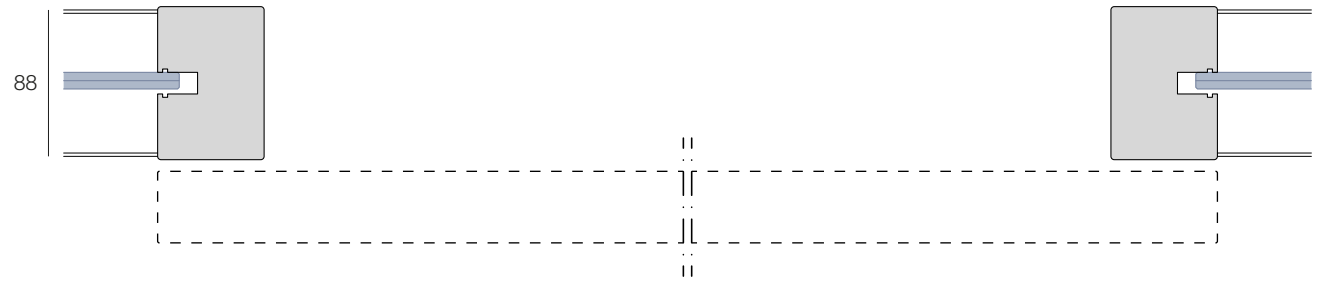

Door frame on **Ritmica Wood D2**

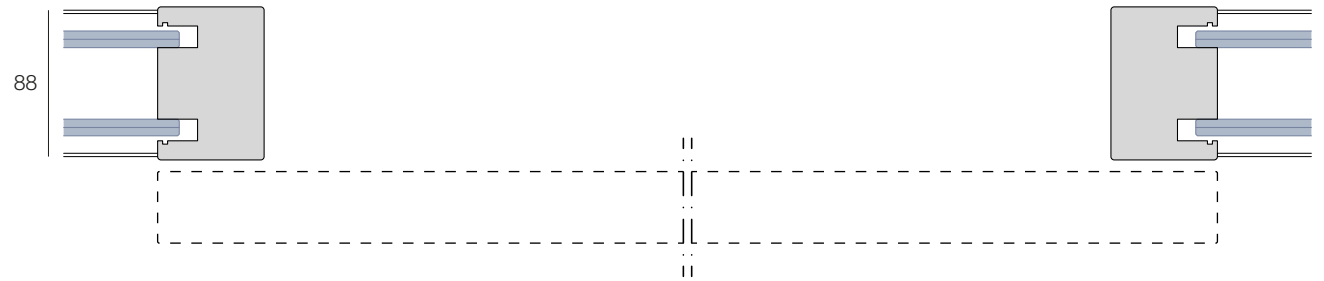

Door frame on **Ritmica Wood Solid**

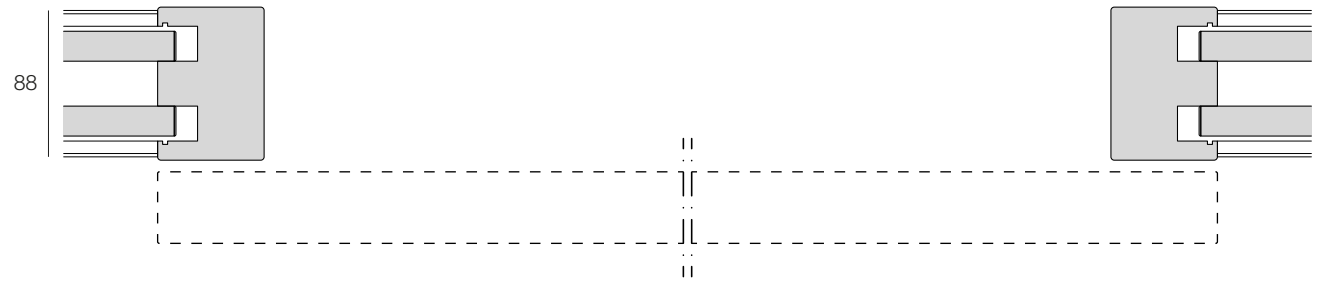

SOLID DOOR LEAF 43 mm thick

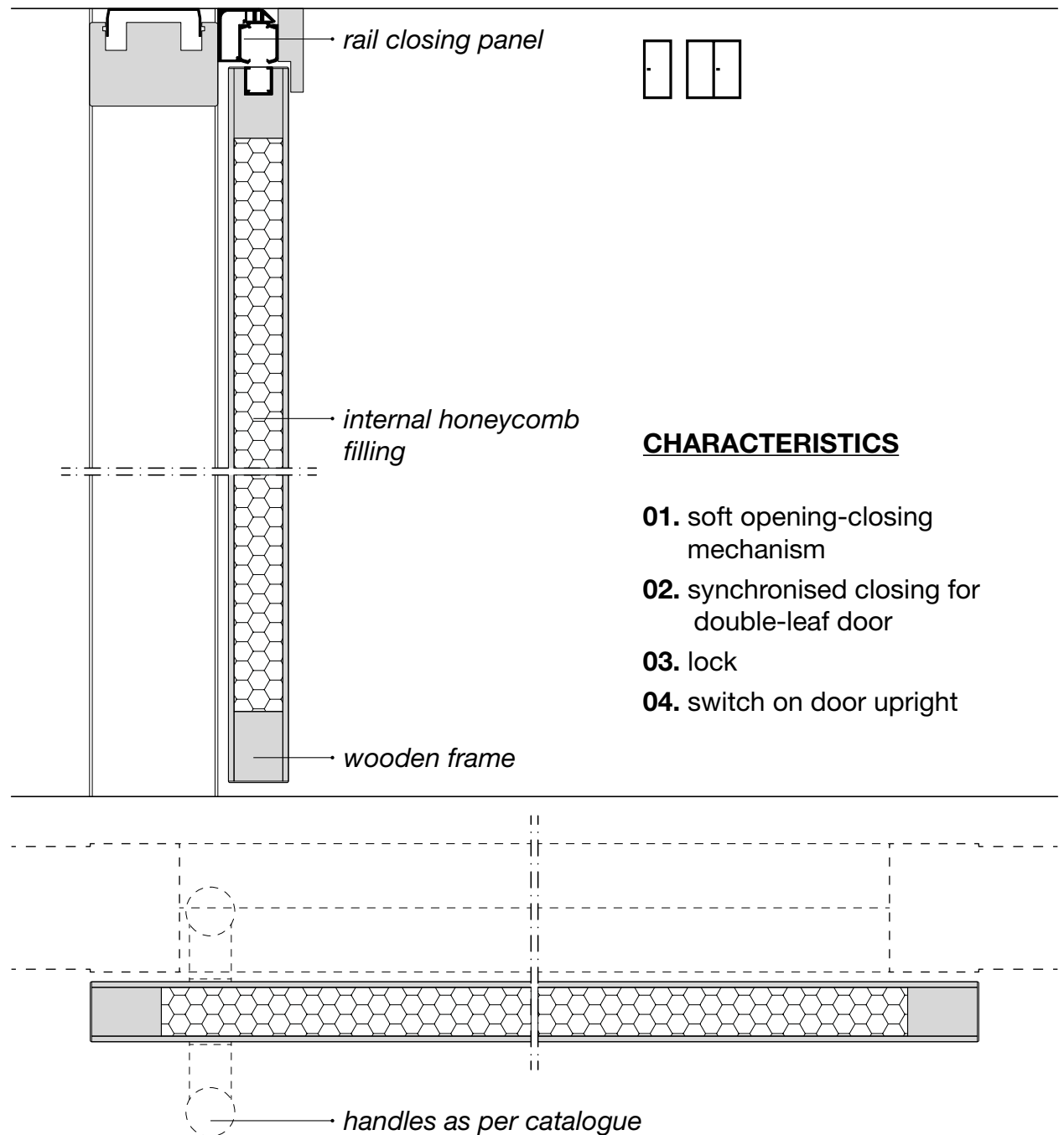

TEMPERED GLASS DOOR LEAF 10 mm thick

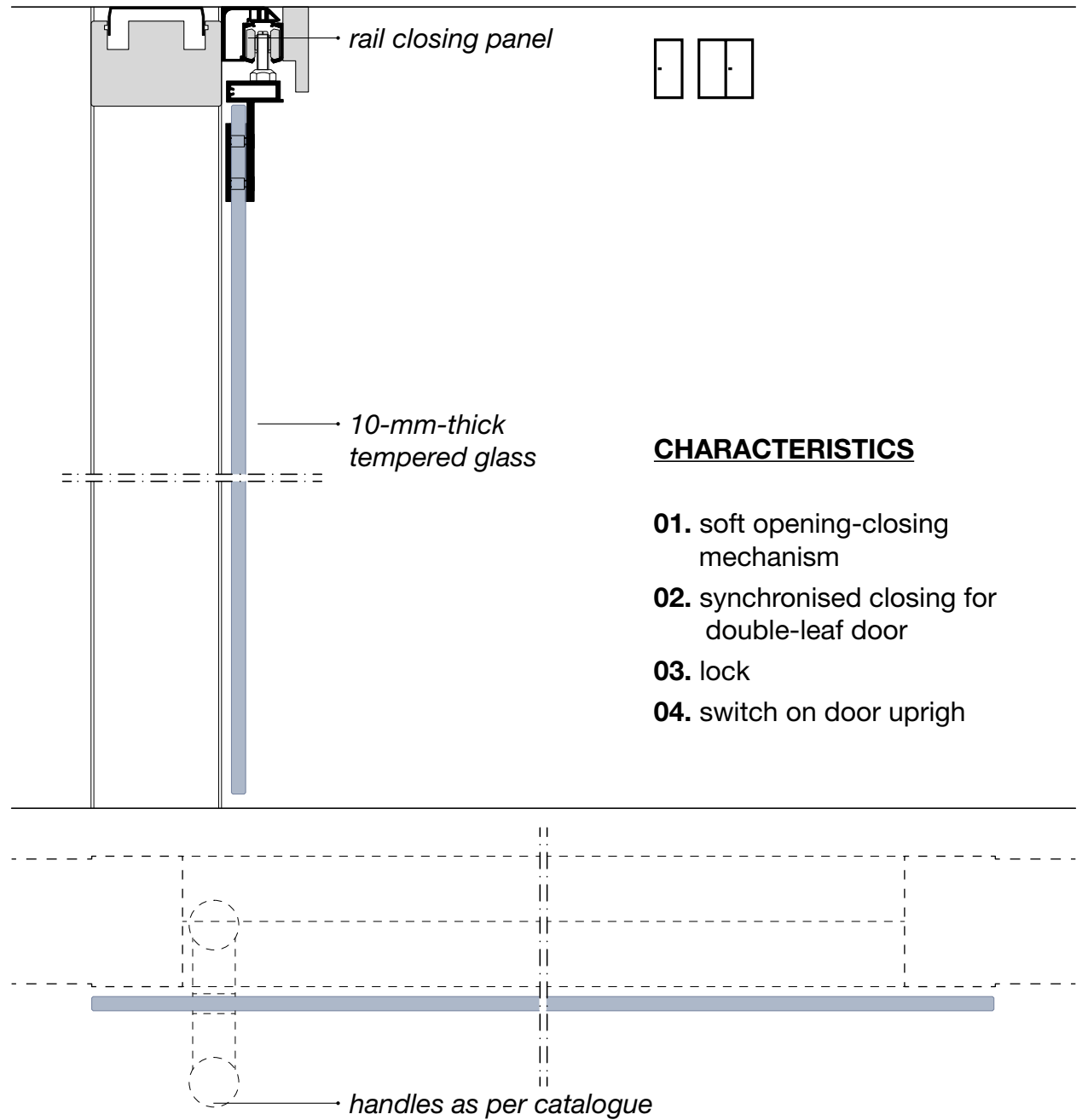

CHARACTERISTICS

- 01.** soft opening-closing mechanism
- 02.** synchronised closing for double-leaf door
- 03.** lock
- 04.** switch on door upright

LARGE FRAMED DOOR LEAF 43 mm thick

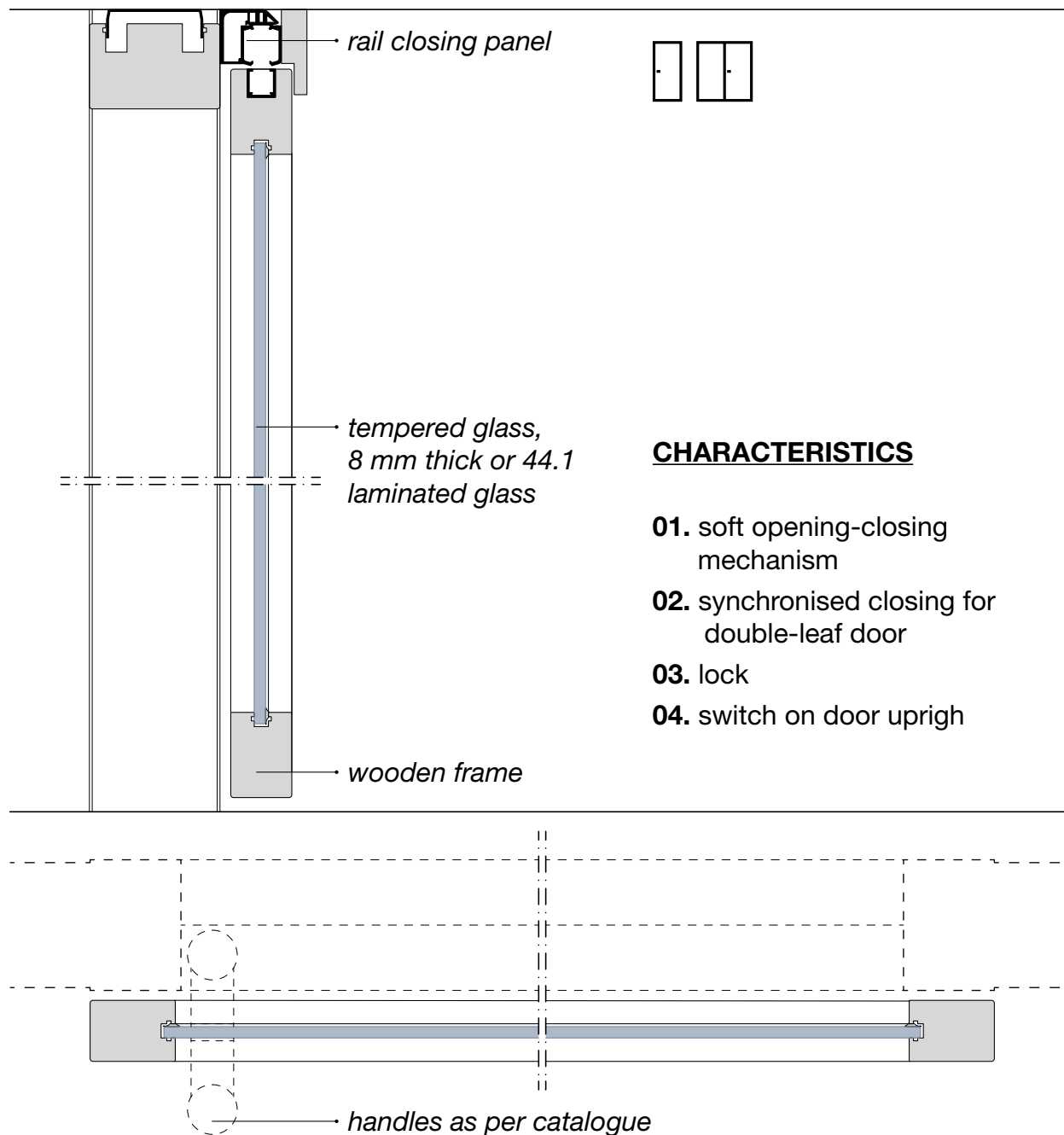

CHARACTERISTICS

- 01.** soft opening-closing mechanism
- 02.** synchronised closing for double-leaf door
- 03.** lock
- 04.** switch on door upright



Glass door

STEEL

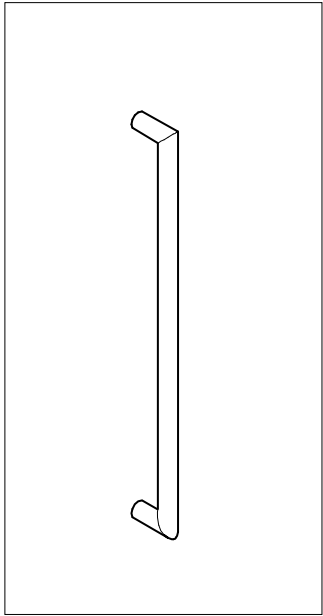

MPOMGH1_H2_H3

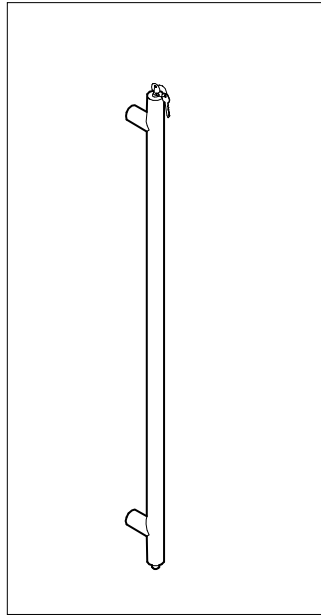

MPOM2

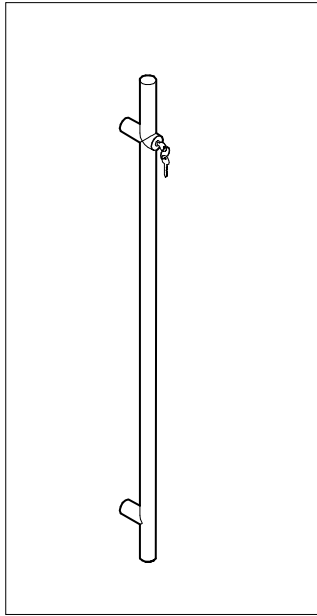

MPOM3

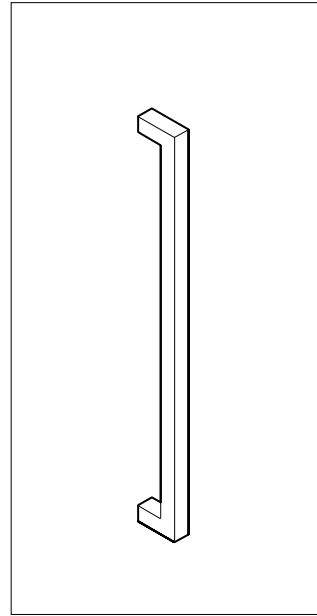

MPOMGH1Q_GH2Q_GH3Q

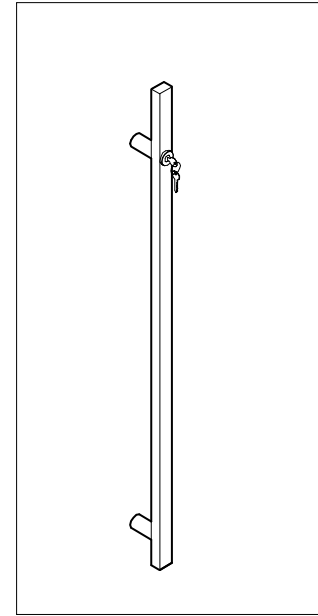

MPOM3Q

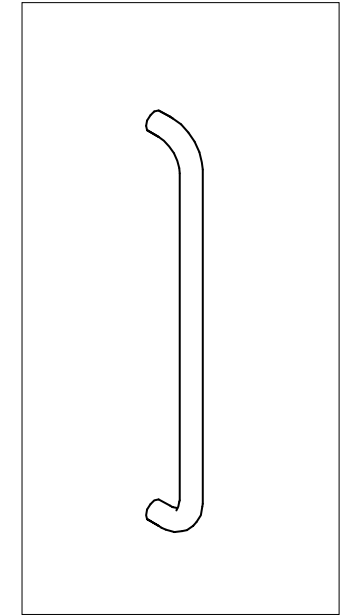

MPOM8

ALUMINIUM

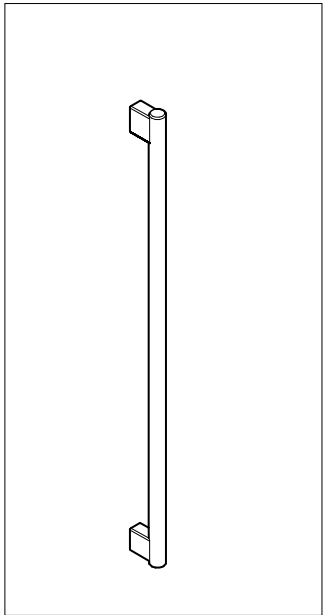

MPOMTH1_TH2

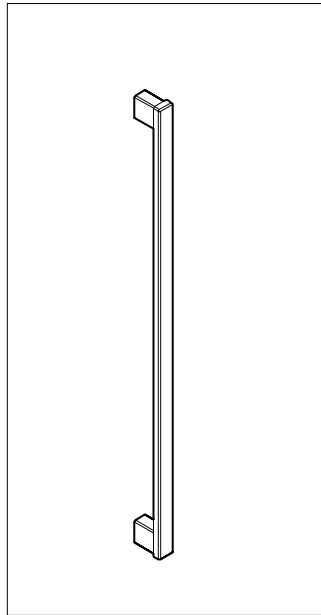

MPOMQH1_QH2

Solid door



STEEL

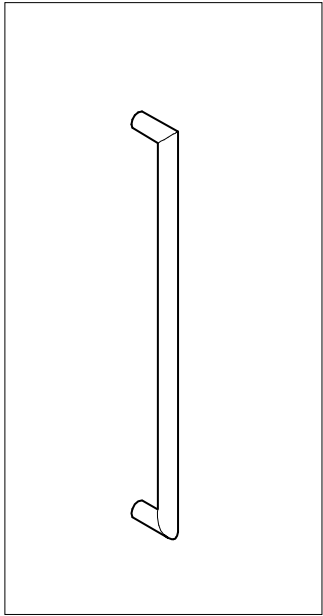

MPOMGH1_H2_H3

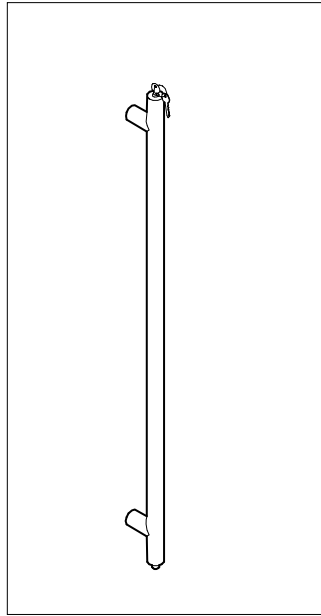

MPOM2

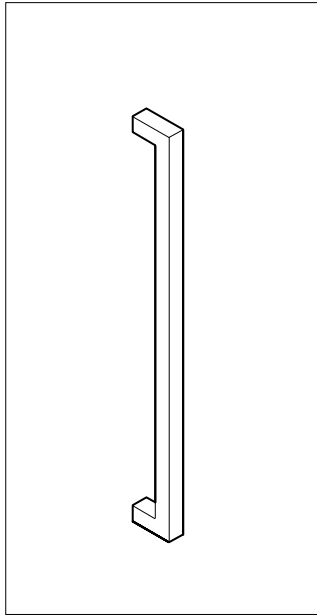

MPOMGH1Q_GH2Q_GH3Q

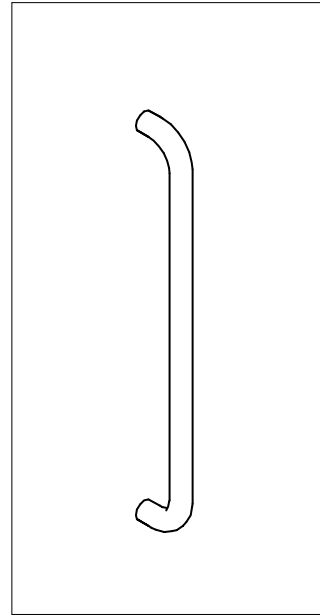

MPOM8

ALUMINIUM

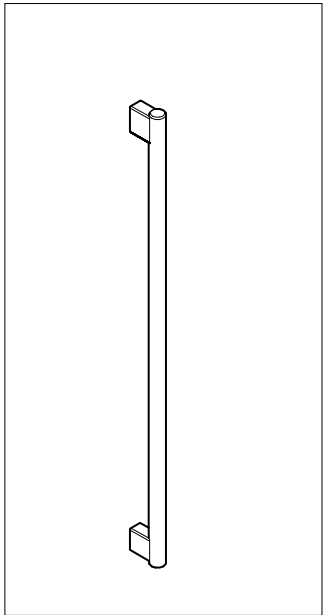

MPOMTH1_TH2

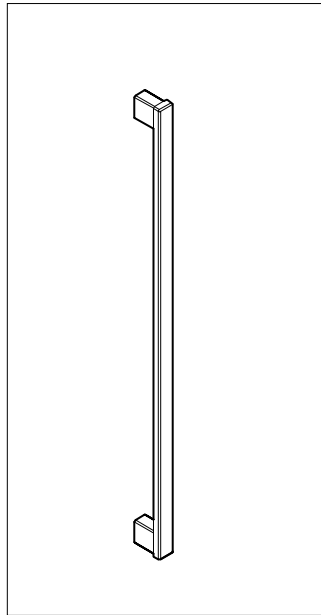

MPOMQH1_QH2

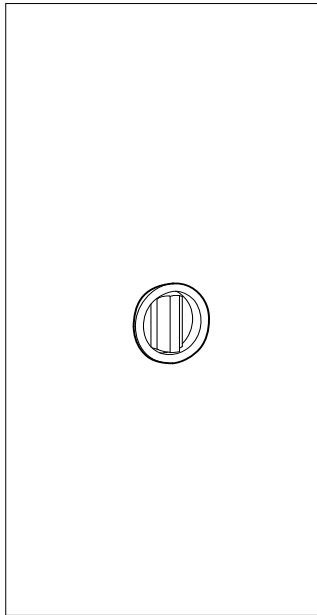

MPOM4

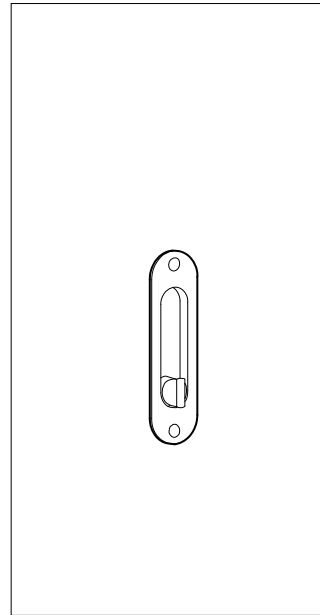

MPOM5

RITMICA®
WOOD

Accessories



Overhead door closer

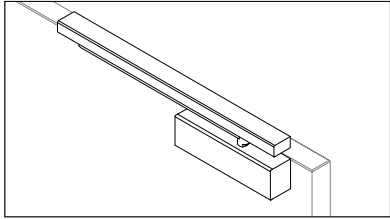

01 external sliding closer
for framed/solid door

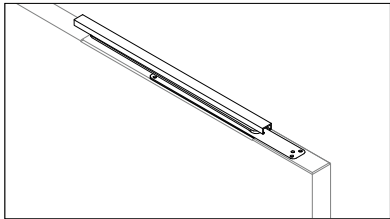

02 concealed closer
for framed/solid door

Floor-mounted door closer

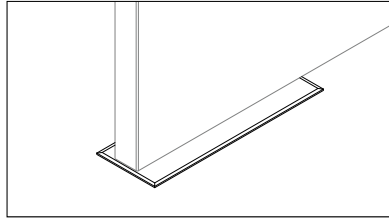

01 floor-mounted
for solid door

Aluminium hinges

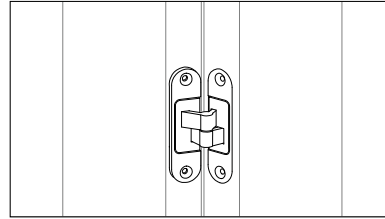

02 concealed
for framed/solid door

Accessories

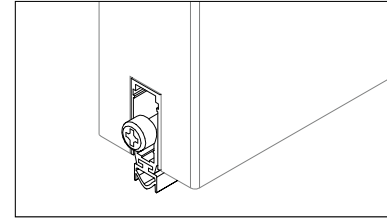

01 concealed soundproofing draft stopper
for framed/solid door

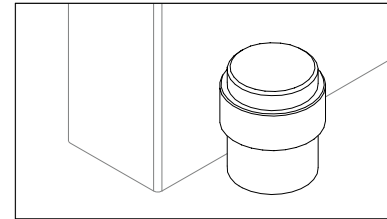

02 door stopper
for solid/framed/tempered glass door

RITMICA®
WOOD

Finishes

Frame



Anodised

RAL Finishes

Polish

Wood



01 Natural aluminium



01 White

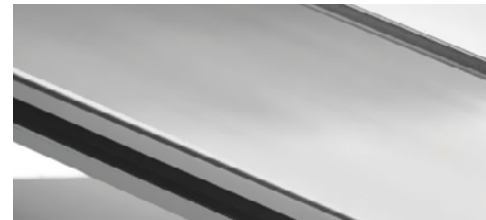

01 Shine



01 Light oak



02 Bronze

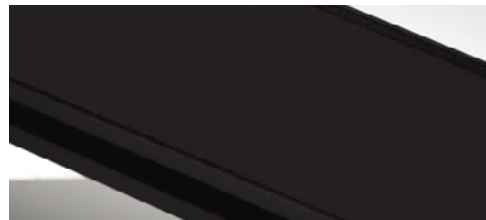

02 Black

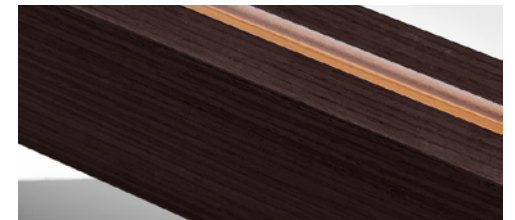

02 Dark oak

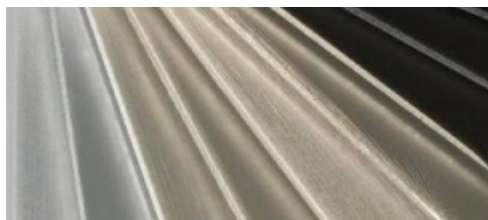

03 Custom colour



03 Custom colour

Solid panels



CAT. 1

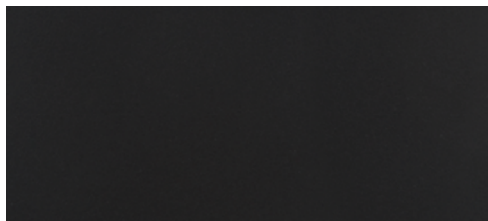

055 Graphite black

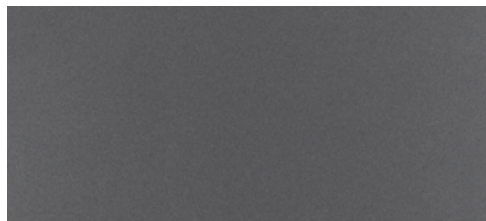

420 Gunmetal



418 Ash grey

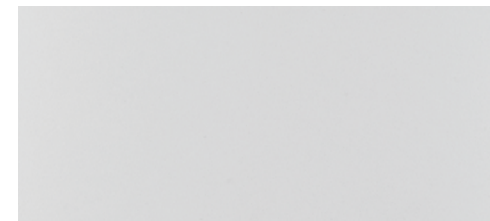

419 Light grey

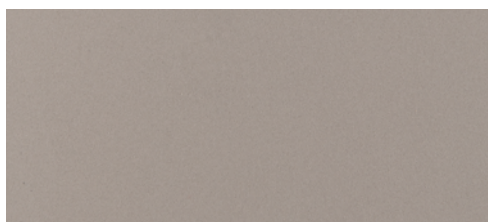

393 Dove grey



417 Vanilla

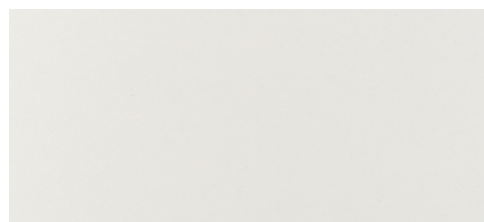

429 Warm white

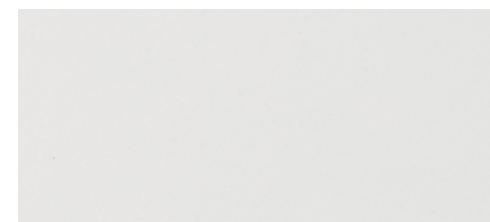

428 Cold white

CAT. 2

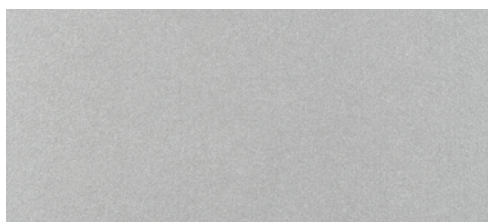

422 Silver

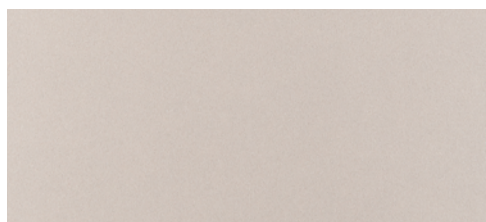

423 Champagne

Woods



CAT. 1

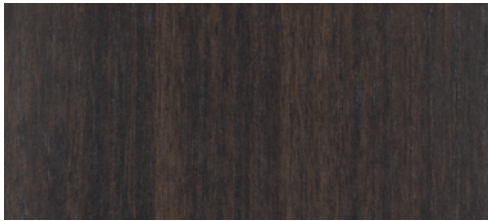

421 Eucaliptus



426 Mid-tone oak



274 Acacia



416 Streaked white

CAT. 2

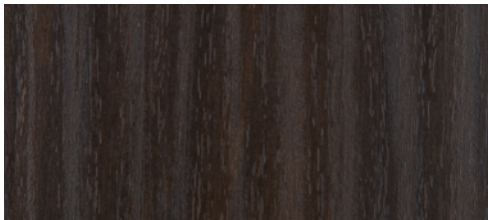

425 Dark walnut

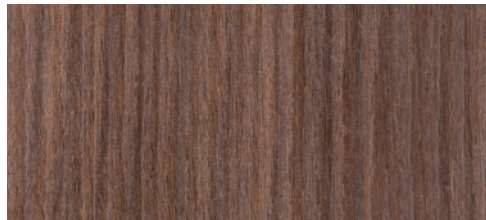

318 Mid-tone walnut

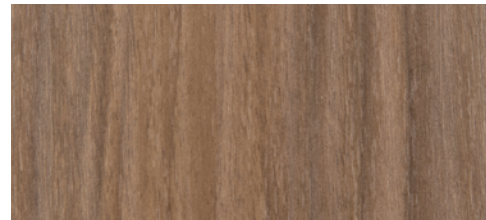

427 Light walnut

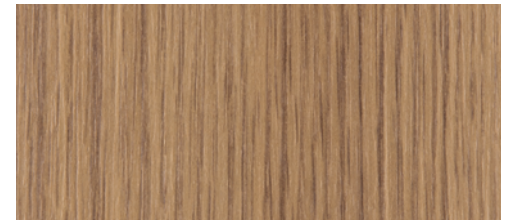

382 Natural oak

CAT. 3

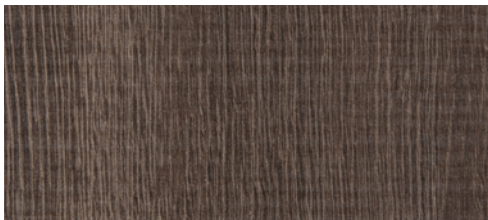

138 Aged saw-cut oak

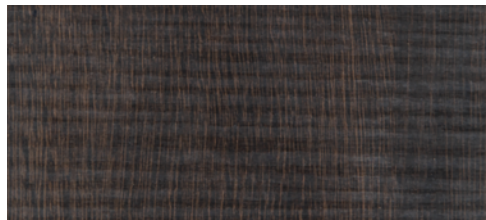

197 Saw-cut eucaliptus

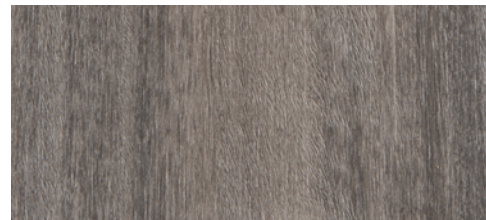

408 Grey oak



400 Danube oak

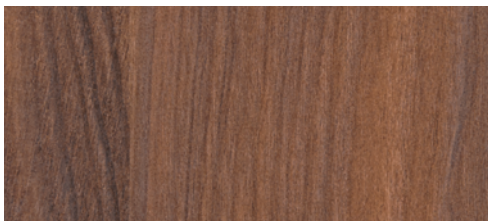

414 Red walnut

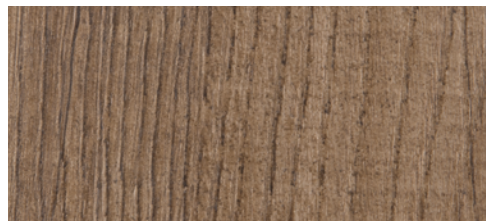

412 Vintage oak

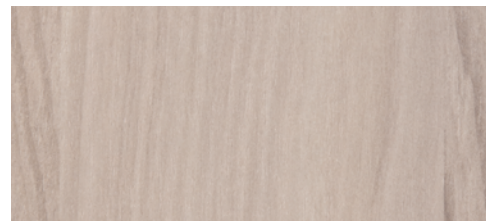

413 Champagne oak



410 Light oak

Textures



CAT. 2



304 Dark-tone fabric



123 Mid-tone fabric



305 Light-tone fabric

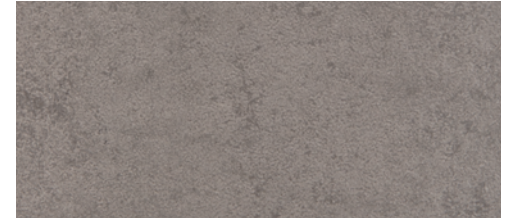

424 Oxide

CAT. 3



385 Bronze linen



409 Bark

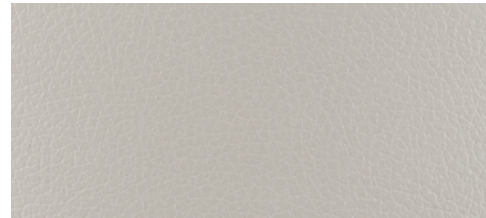

406 Primo fiore grey

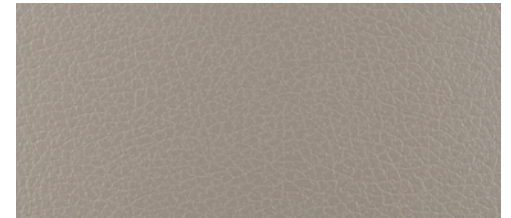

405 Primo fiore dove grey



404 Primo fiore beige



415 Desert

Glass



01 Clear



03 Satin

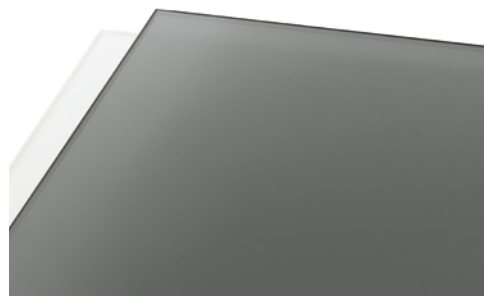

05 Smoked



02 Extra light

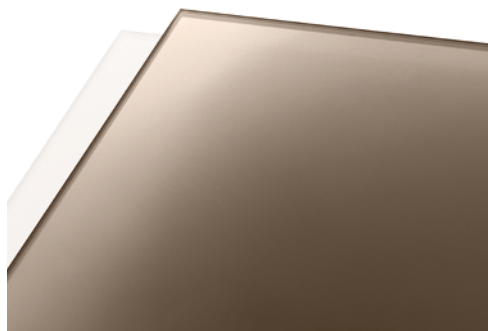

04 Bronze



06 Custom painted



Etoile s.r.l. - Società Unipersonale

Via D. Albertario, 50 61032 Zona Ind.le Bellocchi - Fano (PU) Italy
P. +39.0721.85.59.34 - F. +39.0721.85.92.14
info@etoilesrl.it - www.etoilesrl.it